

CURRICULUM AND DETAILED SYLLABI

FOR

B.E DEGREE (Civil Engineering) PROGRAMME

SECOND TO EIGHT SEMESTER

For the Students admitted from the academic year 2019-2020



THIAGARAJAR COLLEGE OF ENGINEERING

(A Government Aided ISO 9001-2008 certified Autonomous Institution affiliated to Anna University)

MADURAI – 625 015

Approved in 59th Academic Council Meeting held on 07.12.2019

THIAGARAJAR COLLEGE OF ENGINEERING, MADURAI – 625 015
DEPARTMENT OF CIVIL ENGINEERING

I) Vision

To establish process of learning to meet the global standards for sustainable built environment

II) Mission

We are committed to:

- Provide quality education through innovation in teaching and learning practices meeting the global standards
- Encourage faculty and students to carry out socially relevant and forward looking research
- Offer consultancy services using state of the art facilities fulfilling the needs of the industry and society
- Enable our students, faculty and staff to play leadership roles for the betterment of the society in a sustainable manner

III) Programme Educational Objectives (PEOs) for B.E Civil Engineering programme:

PEO1. Graduates of the programme will contribute to the development of sustainable Infrastructure for the betterment of society

PEO2. Graduates of the programme, as an employee of an organization or as an employer, will continuously update their domain knowledge for continuous professional development with focus on research & development and industry interaction

PEO3 Graduates of the programme will accept and create innovations in providing solution for sustainable built environment

PEO4 Graduates of the programme will discharge their duties as professional Civil Engineers with quality and ethics

Consistency of PEOs with Mission of the Department

PEOs/ Mission	M1	M2	M3	M4
PEO 1	-	-	M	S
PEO 2	S	S	S	-
PEO 3	M	M	M	S
PEO 4	M	-	M	M

IV) Programme Specific Outcomes (PSO) for B.E Civil Engineering programme

Graduating Students of B.E. Civil Engineering programme will be able to:

PSO 1: Investigate, Analyze, Plan and Design the problems in multi various domains of civil engineering

PSO 2: Work with ethical principles and sound managerial skills in the promotion of civil engineering infrastructure keeping in mind, health, safety and sustainability of the society

Programme Outcomes (POs) of B.E. (Civil Engineering)

Graduating Students of B.E. Civil Engineering programme will:

1. **Engineering Knowledge:** Apply knowledge of mathematics, science, engineering fundamentals and an engineering specialization to the solution of complex engineering problems.
2. **Problem Analysis:** Identify, formulate, research literature and analyze complex engineering problems reaching substantiated conclusions using first principles of mathematics, natural sciences and engineering sciences.
3. **Design/Development of Solutions:** Design solutions for complex engineering problems and design system components or processes that meet specified needs with appropriate consideration for public health and safety, cultural, societal and environmental considerations.
4. **Conduct investigations of complex problems** using research-based knowledge and research methods including design of experiments, analysis and interpretation of data and synthesis of information to provide valid conclusions.
5. **Modern Tool Usage:** Create, select and apply appropriate techniques, resources and modern engineering and IT tools including prediction and modeling to complex engineering activities with an understanding of the limitations.
6. **The Engineer and Society:** Apply reasoning informed by contextual knowledge to assess societal, health, safety, legal and cultural issues and the consequent responsibilities relevant to professional engineering practice.
7. **Environment and Sustainability:** Understand the impact of professional engineering solutions in societal and environmental contexts and demonstrate knowledge of and need for sustainable development.
8. **Ethics:** Apply ethical principles and commit to professional ethics and responsibilities and norms of engineering practice.
9. **Individual and Team Work:** Function effectively as an individual, and as a member or leader in diverse teams and in multi-disciplinary settings.

10. Communication: Communicate effectively on complex engineering activities with the engineering community and with society at large, such as being able to comprehend and write effective reports and design documentation, make effective presentations and give and receive clear instructions.
11. Project Management and Finance: Demonstrate knowledge and understanding of engineering and management principles and apply these to one's own work, as a member and leader in a team, to manage projects and in multidisciplinary environments.
12. Life-long Learning: Recognize the need for and have the preparation and ability to Engage in independent and life- long learning in the broadest context of technological Change.

Consistency of PEOs with POs of the programme

PEO /PO	PO1	PO2	PO3	PO4	PO5	PO6	PO7	PO8	PO9	PO10	PO11	PO12
PEO1	M	S	M	L	-	S	S	L	L	M	M	M
PEO2	M	M	M	M	L	S	M	M	S	S	S	S
PEO3	S	S	S	S	M	M	S	M	M	M	L	M
PEO4	S	S	S	S	L	L	M	M	M	M	M	M

Credit Distribution for B E Civil Engineering Programme

S.No	Category		Credits
A.	Foundation Courses		53-58
	a.	Humanities and Social Science (HSS)	9-11
	b.	Basic Science (BS)	21
	c.	Engineering Science (ES)	23-26
B.	Core Courses		55
C.	Elective Courses		24-48
	a.	Programme Specific Electives	12-24
	b.	Prog. Specific Electives for Expanded Scope	6-12
	c.	Interdisciplinary Elective	3-6
	d.	Foundation Elective	3-6
	e.	Elective (PSE,PSEES,FE)	3
D.	Project		15
E	Mandatory Courses Environment Science, Induction Programme, Indian Constitution, Essence of Indian Tradition knowledge, consumer Affairs (as per UGC guideline)		Non-Credit (Not included for CGPA)
	Minimum Credits to be earned for the award of the degree		160 (from A to D) and the successful completion of Mandatory Courses

Schedule of Courses

SEM	Theory				Theory Cum Practical		Practical			Mandatory Audit Courses	Credits
	1	2	3	4	5	6	7	8	9	10	
I	18MA110 Engineering Calculus (4)	18PHB20 Physics (3)	18CHB30 Chemistry (3)	18EG180 English (2)	18ES150 Engineering Exploration (3)	18ME160 Engineering Graphics (4)	18EG170 English Laboratory (1)	18PH180 Physics Laboratory (1)	18CH190 Chemistry Laboratory (1)	-	22
II	18MA210 Matrices and Ordinary differential equations (3)	18CE220 Surveying (3)	18CE230 Engineering Mechanics (3)	18CEEX0 Engineering Sciences Elective (3)	-	18CE260 Building Materials and Technology(3)	18CE270 Survey lab (1)	18CE280 Workshop (1)	18ES290 Lateral Thinking(1)	18CHAA0 Environmental Sciences	18
III	18CE310 Differential Equations and Fourier Series(3)	18CE320 Mechanics of Solids (3)	18CE330 Fluid Mechanics (3)	18CE340 Water Supply Engineering (3)	18CE350 Programming for Problem Solving (2)	-	18CE370 Computer Aided Drafting Lab (1)	-	18ES390 Design Thinking (2)	-	17
IV	18CE410 Probability and Statistics (3)	18CE420 Structural Analysis (3)	18CE430 Hydraulics and Hydraulic Machinery (3)	18CE440 Wastewater Engineering (3)	18CEFX0 Foundation Elective(3)	18EG460 Professional Communication (2)	18CE470 Programming and coding Lab(1)	18CE480 Fluid Mechanics and Machinery Lab (1)	18CE490 Project Management (3)	Constitution of India	22
V	18CE510 Concrete Technology (3)	18CE520 Soil Mechanics (3)	18CE530 Accounting and Finance (3)	18CEPX0 Programme Elective -I (3)	18CEGX0 General Elective (3)	18CE560 Design of Steel Elements (3)	18CE570 Materials Testing lab (1)	18CE580 Environmental Engineering lab (1)	18ES590 Capstone Design Project (3)	-	23
VI	18CE610 Foundation Engineering (3)	18CE620 Highway and Railway Engineering (3)	18CE630 Data Structures (3)	18CEPX0 Programme Elective - II (3)	Elective (PSE or PSEES or FE) (3)	18CE660 Design of Reinforced Concrete Elements (3)	18CE670 Soil and Highway Engineering Lab (1)	-	18ES690 Engineering Design Project (3)	---	22
VII	18CE710 Irrigation and Water Resources Engineering (3)	18CE720 Construction Management (2)	18CEPX0 Programme Elective- III (3)	18CEPX0 Programme Elective- IV (3)	18CEPX0 Programme Elective-V (3)	-	18CE770 Estimation and Costing Lab (2)	---	18ES790 System Thinking (2)	---	18
VIII	18CEPX0 Programme Elective -VI (3)	18CEPX0 Programme Elective - VII (3)	18CEPX0 Programme Elective VIII (3)	-	---	---	18CE870 Project (9)	---	-	---	18
Total Credits											160

THIAGARAJAR COLLEGE OF ENGINEERING: MADURAI – 625 015**B.E Degree (Civil Engineering) Programme****COURSES OF STUDY**

(For the candidates admitted from 2018-2019 onwards)

SECOND SEMESTER

Course code	Name of the Course	Category **	No. of Hours / Week			Credits
			L	T	P	
THEORY						
18MA210	Matrices and ordinary Differential Equations	BS	3	0	0	3
18CE220	Surveying	PC	3	0	0	3
18CE230	Engineering Mechanics	ES	2	1	0	3
18CEEX0	Engineering Science Elective	ES	3	0	0	3
18CHAA0	Environmental Sciences	AC	1	0	1	-
THEORY CUM PRACTICAL						
18CE260	Building Materials and Technology	PC	2	0	2	3
PRACTICAL						
18CE270	Survey lab	PC	0	0	2	1
18CE280	Workshop	ES	0	0	2	1
18ES290	Lateral Thinking	ES	0	0	2	1
Total			14	1	8	18

THIRD SEMESTER

Course code	Name of the Course	Category **	No. of Hours / Week			Credits
			L	T	P	
THEORY						
18CE310	Differential Equations and Fourier Series	BS	3	0	0	3
18CE320	Mechanics of Solids	PC	2	1	0	3
18CE330	Fluid Mechanics	PC	2	1	0	3
18CE340	Water Supply Engineering	PC	2	1	0	3
18CE350	Programming for Problem solving	ES	2	0	0	2
THEORY CUM PRACTICAL						
18ES390	Design Thinking	ES	1	0	2	2
PRACTICAL						
18CE370	Computer Aided Drafting Lab	PC	0	0	2	1
Total			12	3	4	17

FOURTH SEMESTER

Course code	Name of the Course	Category **	No. of Hours / Week			Credits
			L	T	P	
THEORY						
18CE410	Probability and Statistics	BS	3	0	0	3
18CE420	Structural Analysis	PC	2	1	0	3
18CE430	Hydraulics and hydraulic Machinery	PC	2	1	0	3
18CE440	Wastewater Engineering	PC	2	1	0	3
18CEFX0	Foundation Elective	ES	3	0	0	3
18CE490	Project Management	HSS	2	1	0	3
THEORY CUM PRACTICAL						
18EG460	Professional Communication	HSS	0	1	2	2
PRACTICAL						
18CE470	Programming And Coding Lab	ES	0	0	2	1
18CE480	Fluid Mechanics And Machinery Lab	PC	0	0	2	1
Total			14	5	6	22

FIFTH SEMESTER

Course code	Name of the Course	Category **	No. of Hours / Week			Credits
			L	T	P	
THEORY						
18CE510	Concrete Technology	PC	3	0	0	3
18CE520	Soil Mechanics	PC	3	0	0	3
18CE530	Accounting and Finance	HSS	3	0	0	3
18CEPX0	Programme Elective -I	PE	3	0	0	3
18CEGX0	General Elective	GE	3	0	0	3
THEORY CUM PRACTICAL						
18CE560	Design of Steel Elements	PC	3	0	0	3
PRACTICAL						
18CE570	Materials Testing Lab	PC	0	0	2	1
18CE580	Environmental Engineering Lab	PC	0	0	2	1
18ES590	Capstone Design Project	ES	2	0	2	3
Total			20	0	6	23

SIXTH SEMESTER

Course code	Name of the Course	Category **	No. of Hours / Week			Credits
			L	T	P	
THEORY						
18CE610	Foundation Engineering	PC	3	0	0	3
18CE620	Highway And Railway Engineering	PC	3	0	0	3
18CE630	Data Structures	PC	3	0	0	3
18CEPX0	Programme Elective -II	PE	3	0	0	3
18CEXX0	Elective (PSE or PSE Expanded or Foundation Elective)		3	0	0	3
THEORY CUM PRACTICAL						
18CE660	Design of Reinforced Concrete Elements	PC	2	0	2	3
PRACTICAL						
18CE670	Soil and Highway Engineering Lab	PC	0	0	2	1
18ES690	Engineering Design Project	ES	0	0	6	3
Total			17	0	10	22

SEVENTH SEMESTER

Course code	Name of the Course	Category **	No. of Hours / Week			Credits
			L	T	P	
THEORY						
18CE710	Irrigation and Water Resources Engineering	PC	3	0	0	3
18CE720	Construction Management	PC	2	0	0	2
18CE PX0	Programme Elective - III	PE	3	0	0	3
18CEPX0	Programme Elective - IV	PE	3	0	0	3
18CE PX0	Programme Elective - V	PE	3	0	0	3
PRACTICAL						
18CE770	Estimation and Costing Lab	PC	1	0	2	2
18ES790	System Thinking	ES	1	0	2	2
Total			16	0	4	18

EIGHTH SEMESTER

Course code	Name of the Course	Category **	No. of Hours / Week			Credits
			L	T	P	
THEORY						
18CE PX0	Programme Elective – VI	PE	3	0	0	3
18CEPX0	Programme Elective - VII	PE	3	0	0	3
18CE PX0	Programme Elective - VIII	PE	3	0	0	3
PRACTICAL						
18CE 870	Project	PC	0	0	18	9
Total			9	0	18	18

** BS - Basic Science; PC- Programme Core; ES - Engineering Science; HSS – Humanities and Social Science; AC - Audit Course; PE - Programme Elective

Note:

1 Hour Lecture/Tutorial is equivalent to 1 credit

2 Hours Practical is equivalent to 1 credit

THIAGARAJAR COLLEGE OF ENGINEERING: MADURAI – 625 015**B.E Degree (Civil Engineering) Programme****SCHEME OF EXAMINATIONS**

(For the candidates admitted from 2018-2019 onwards)

SECOND SEMESTER

S.No.	Sub. Code	Name of the subject	Duration of Terminal Exam. in Hrs.	Marks			Minimum Marks for Pass	
				Continuou s Assessment *	Termin al Exam **	Max. Mark s	Terminal Exam	Total
THEORY								
1	18MA210	Matrices and ordinary Differential Equations	3	50	50	100	25	50
2	18CE220	Surveying	3	50	50	100	25	50
3	18CE230	Engineering Mechanics	3	50	50	100	25	50
4	18CEEX0	Engineering Sciences Elective	3	50	50	100	25	50
5	18CHAA0	Environmental Sciences	-	50	50	100	25	50
THEORY CUM PRACTICAL								
6	18CE260	Building Materials and Technology	3	50	50	100	25	50
PRACTICAL								
7	18CE270	Survey lab	3	50	50	100	25	50
8	18CE280	Workshop	3	50	50	100	25	50
9	18ES290	Lateral Thinking	-	50	50	100	25	50

THIRD SEMESTER

S. No.	Sub. Code	Name of the subject	Duration of Terminal Exam. In Hrs.	Marks			Minimum Marks for Pass	
				Continuous Assessment *	Termin al Exam **	Max. Mark s	Terminal Exam	Total
THEORY								
1	18CE310	Differential Equations and Fourier Series	3	50	50	100	25	50
2	18CE320	Mechanics of Solids	3	50	50	100	25	50
3	18CE330	Fluid Mechanics	3	50	50	100	25	50

4	18CE340	Water Supply Engineering	3	50	50	100	25	50
5	18CE350	Programming for Problem solving	3	50	50	100	25	50
THEORY CUM PRACTICAL								
6	18ES390	Design Thinking	-	50	50	100	25	50
PRACTICAL								
7	18CE370	Computer Aided Drafting Lab	3	50	50	100	25	50

FOURTH SEMESTER

S. No.	Sub. Code	Name of the subject	Duration of Terminal Exam. in Hrs.	Marks			Minimum Marks for Pass	
				Continuous Assessment*	Terminal Exam**	Max. Marks	Terminal Exam	Total
THEORY								
1	18CE410	Probability and Statistics	3	50	50	100	25	50
2	18CE420	Structural	3	50	50	100	25	50
3	18CE430	Hydraulics and hydraulic Machinery	3	50	50	100	25	50
4	18CE440	Wastewater Engineering	3	50	50	100	25	50
5	18CEFX0	Foundation Elective	3	50	50	100	25	50
6	18CE490	Project Management	3	50	50	100	25	50
THEORY CUM PRACTICAL								
7	18EG460	Professional Communication	3	50	50	100	25	50
PRACTICAL								
8	18CE470	Programming And Coding Lab	3	50	50	100	25	50
9	18CE480	Fluid Mechanics And Machinery	3	50	50	100	25	50

FIFTH SEMESTER

S. No.	Sub. Code	Name of the subject	Duration of Terminal Exam. in Hrs.	Marks			Minimum Marks for Pass	
				Continuous Assessment*	Terminal Exam**	Max. Marks	Terminal Exam	Total
THEORY								
1	18CE510	Concrete Technology	3	50	50	100	25	50
2	18CE520	Soil Mechanics	3	50	50	100	25	50

3	18CE530	Accounting and Finance	3	50	50	100	25	50
4	18CEPX0	Programme Elective-I	3	50	50	100	25	50
5	18CEGX0	General Elective	3	50	50	100	25	50
THEORY CUM PRACTICAL								
6	18CE560	Design of Steel Elements	3	50	50	100	25	50
PRACTICAL								
7	18CE570	Materials Testing Lab	3	50	50	100	25	50
8	18CE580	Environmental Engineering Lab	3	50	50	100	25	50
9	18ES590	Capstone Design Project	-	50	50	100	25	50

SIXTH SEMESTER

S. No.	Sub. Code	Name of the subject	Duration of Terminal Exam. in Hrs.	Marks			Minimum Marks for Pass	
				Continuous Assessment ^{t*}	Terminal Exam ^{**}	Max. Marks	Terminal Exam	Total
THEORY								
1	18CE610	Foundation Engineering	3	50	50	100	25	50
2	18CE620	Highway and Railway Engineering	3	50	50	100	25	50
3	18CE630	Data Structures	3	50	50	100	25	50
4	18CEPX0	Programme Elective -II	3	50	50	100	25	50
5	18CEXX0	Elective (PSE or PSE Expanded or Foundation Elective)	3	50	50	100	25	50
THEORY CUM PRACTICAL								
6	18CE660	Design of Reinforced Concrete Elements	3	50	50	100	25	50
PRACTICAL								
7	18CE670	Soil and Highway Engineering Lab	3	50	50	100	25	50
8	18ES690	Engineering Design Project	-	50	50	100	25	50

SEVENTH SEMESTER

S. No.	Sub. Code	Name of the subject	Duration of Terminal Exam. in Hrs.	Marks			Minimum Marks for Pass	
				Continuous Assessment ^{t*}	Terminal Exam ^{**}	Max. Marks	Terminal Exam	Total
THEORY								
1	18CE710	Irrigation and Water Resources Engineering	3	50	50	100	25	50
2	18CE720	Construction Management	3	50	50	100	25	50
3	18CE PX0	Programme Elective - III	3	50	50	100	25	50
4	18CEPX0	Programme Elective - IV	3	50	50	100	25	50
5	18CE PX0	Programme Elective - V	3	50	50	100	25	50
PRACTICAL								
6	18CE770	Estimation and Costing Lab	3	50	50	100	25	50
7	18ES790	System Thinking	-	50	50	100	25	50

EIGHTH SEMESTER

S. No.	Sub. Code	Name of the subject	Duration of Terminal Exam. in Hrs.	Marks			Minimum Marks for Pass	
				Continuous Assessment ^{t*}	Terminal Exam ^{**}	Max. Marks	Terminal Exam	Total
THEORY								
1	18CE PX0	Programme Elective – VI	3	50	50	100	25	50
2	18CEPX0	Programme Elective - VII	3	50	50	100	25	50
3	18CE PX0	Programme Elective - VIII	3	50	50	100	25	50
PRACTICAL								
4	18CE 870	Project	-	150	150	300	75	100

*Continuous Assessment evaluation pattern will differ from subject to subject and for different tests. This will have to be declared in advance to students.

** Terminal Examination will be conducted for maximum marks of 100 and subsequently be reduced to 50 marks for the award of terminal examination marks.

THIAGARAJAR COLLEGE OF ENGINEERING, MADURAI- 625 015

(A Govt. Aided, ISO 9001:2008 certified Autonomous Institution affiliated to Anna University)

CATEGORIZATION OF COURSES

(Choice Based Credit System)

Degree: B.E./B.Tech

Programme: B.E Civil Engineering(2018-2019)

A. Foundation Courses:

a. Humanities and Social Science : Credits to be earned 9-11

S.No	Course Code	Name of the Course	Number of Hours / Week			Credit	Pre requisite (if any)
			L	T	P		
THEORY							
1.	18EG180	English	2	-	-	2	
2.	18CE490	Project Management	2	1	-	3	
3.	18CE530	Accounting and Finance	3	-	-	3	
THEORY CUM PRACTICAL							
1.	18EG460	Professional Communication	-	1	2	2	
PRACTICAL							
1.	18EG170	English Lab	-	-	2	1	

b. Basic Science : Credits to be earned 21

S.No	Course Code	Name of the Course	Number of Hours / Week			Credit	Pre requisite (if any)
			L	T	P		
THEORY							
1.	18MA110	Engineering Calculus	3	1	-	4	
2.	18PHA20	Physics	3	-	-	3	
3.	18CHB30	Chemistry	3	-	-	3	
4.	18MA210	Matrices and Ordinary differential equations	3	-	-	3	
5.	18CE310	Differential Equations and Fourier Series	3	-	-	3	
6.	18CE410	Probability and Statistics	3	-	-	3	
PRACTICAL							
1.	18PH180	Physics Laboratory	-	-	2	1	
2.	18CH190	Chemistry Laboratory	-	-	2	1	

c. Engineering Science: Credits to be earned 23-26

S.No	Course Code	Name of the Course	Number of Hours / Week			Credit	Pre requisite (if any)
			L	T	P		
THEORY							
1.	18ES150	Engineering Exploration	3	-	-	3	
2.	18CE230	Engineering Mechanics	2	1	-	3	
3.	18CE350	Programming for Problem Solving	2	-	-	2	
4.	18ES390	Design Thinking	1	-	2	2	
6.	18CEEX0	Engineering Science Elective	3	-	-	3	

THIAGARAJAR COLLEGE OF ENGINEERING, MADURAI- 625 015

(A Govt. Aided, ISO 9001:2008 certified Autonomous Institution affiliated to Anna University)

CATEGORIZATION OF COURSES

(Choice Based Credit System)

THEORY CUM PRACTICAL							
1.	18ME160	Engineering Graphics	3	-	2	4	
PRACTICAL							
1.	18CE280	Workshop	-	-	2	1	
2.	18ES290	Lateral Thinking	-	-	2	1	
3.	18CE470	Programming and Coding Lab	-	-	2	1	
4.	18ES790	System Thinking	1		2	2	

B. Professional Core Courses: Credits to be earned 55

S.No	Course Code	Name of the Course	Number of Hours / Week			Credit	Pre requisite (if any)
			L	T	P		
THEORY							
1.	18CE220	Surveying	3	-	-	3	
2.	18CE320	Mechanics of Solids	2	1	-	3	
3.	18CE330	Fluid Mechanics	2	1	-	3	
4.	18CE340	Water Supply Engineering	2	1	-	3	
5.	18CE420	Structural Analysis	2	1	-	3	
6.	18CE430	Hydraulics & Hydraulic Machinery	2	1	-	3	
7.	18CE440	Wastewater Engineering	2	1	-	3	
8.	18CE510	Concrete Technology	3	-	-	3	
9.	18CE520	Soil Mechanics	3	-	-	3	
10.	18CE610	Foundation Engineering	3	-	-	3	
11.	18CE620	Highway and Railway Engineering	3	-	-	3	
12.	18CE630	Data Structures	3	-	-	3	
13.	18CE710	Irrigation and Water Resources Engineering	3	-	-	3	
14.	18CE720	Construction Management	2	-	-	2	
THEORY CUM PRACTICAL							
1.	18CE260	Building Materials and Technology	2	-	2	3	
2.	18CE560	Design of Steel Elements	3	-	-	3	
3.	18CE660	Design of Reinforced Concrete Elements	2	-	2	3	
PRACTICAL							
1.	18CE270	Survey Lab	-	-	2	1	
2.	18CE370	Computer Aided Drafting Lab	-	-	2	1	
3.	18CE480	Fluid Mechanics And Machinery Lab	-	-	2	1	
4.	18CE570	Materials Testing Lab	-	-	2	1	
5.	18CE580	Environmental Engineering Lab	-	-	2	1	
6.	18CE670	Soil and Highway Engineering Lab	-	-	2	1	

THIAGARAJAR COLLEGE OF ENGINEERING, MADURAI- 625 015
(A Govt. Aided, ISO 9001:2008 certified Autonomous Institution affiliated to Anna University)
CATEGORIZATION OF COURSES
(Choice Based Credit System)

7.	18CE770	Estimation and Costing Lab	1	-	2	2	
----	---------	-------------------------------	---	---	---	---	--

C. Elective Courses:**a. Programme Specific Elective : Credits to be earned 12-24**

S.No	Course Code	Name of the Course	Number of Hours / Week			Credit	Pre requisite (if any)
			L	T	P		
THEORY							
1.	18CEPA0	Finite Element Analysis	3	-	-	3	
2.	18CEPB0	Dynamics of Structures and Earthquake Engineering	3	-	-	3	
3.	18CEPC0	Prestressed Concrete	3	-	-	3	
4.	18CEPD0	Bridge Engineering	3	-	-	3	
5.	18CEPE0	Fracture Mechanics	3	-	-	3	
6.	18CEPF0	Instrumentation in Civil Engineering	3	-	-	3	
7.	18CEPG0	Design Of Reinforced Concrete Special Structures	3	-	-	3	
8.	18CEPH0	Municipal Solid Waste Management	3	-	-	3	
9.	18CEPJ0	Air and Noise Pollution Management	3	-	-	3	
10.	18CEPK0	Basics of Remote Sensing	3	-	-	3	
11.	18CEPL0	Environmental Impact Assessment	3	-	-	3	
12.	18CEPM0	Disaster Mitigation and Management	3	-	-	3	
13.	18CEPN0	Ground Water Management	3	-	-	3	
14.	18CEPP0	Waste Management	3	-	-	3	
15.	18CEPQ0	Ground Improvement Techniques	3	-	-	3	
16.	18CEPR0	Traffic Engineering and Safety	3	-	-	3	
17.	18CEPS0	Repair and Rehabilitation of Structures	3	-	-	3	
18.	18CEPT0	Engineering Hydrology	2	1	-	3	
19.	18CEPU0	Airways and Waterways	3	-	-	3	
20.	18CEPV0	Computational Methods in Structural Analysis	3	-	-	3	

b. Programme Specific Elective for Expanded Scope: Credits to be earned 6-12

S.No	Course Code	Name of the Course	Number of Hours / Week			Credit	Pre requisite (if any)
			L	T	P		
THEORY							
1.	18CERA0	Aseismic Design of Structures	3	-	-	3	
2.	18CERB0	Experimental Technique and Instrumentations	3	-	-	3	
3.	18CERC0	Computer Aided Design	3	-	-	3	

4.	18CERD0	Anti-terrorism Design of Structures	3	-	-	3	
5.	18CERE0	Resource and Energy Recovery from Wastes	3	-	-	3	
6.	18CERF0	Industrial Waste water Management	3	-	-	3	
7.	18CERG0	Sustainable Management of Urban Ecology	3	-	-	3	
8.	18CERH0	Construction Equipment Management	2	1	-	3	
9.	18CERJ0	Management of Human Resources, Safety and Quality	3	-	-	3	
10.	18CERK0	Material Procurement And Management	3	-	-	3	
11.	18CERL0	Contracts and Arbitration	3	-	-	3	
12.	18CERM0	Design of Reinforced Concrete Structures	3	-	-	3	
13.	18CERN0	Design of Steel Structures	3	-	-	3	
14.	18CE1A0	Arbitration and Dispute Resolution	1	-	-	1	
15.	18CE1B0	Green Construction	1	-	-	1	
16.	18CE1C0	Precast technology in buildings	1	-	-	1	
17.	18CE1D0	Framing of Structures and Optimum Foundation Systems	1	-	-	1	
18.	18CE1E0	Large Scale Systems	1	-	-	1	
19.	18CE1F0	Interior Design	1	-	-	1	
20.	18CE1G0	Forensic Geotechnical Engineering	1	-	-	1	
21.	18CE1H0	Fecal Sludge Management	1	-	-	1	

c. General Elective : Credits to be earned 3-6

S.No	Course Code	Name of the Course	Number of Hours / Week			Credit	Pre requisite (if any)
			L	T	P		
THEORY							
1.	18CEGA0	Sustainable Development	3	-	-	3	
2.	18CEGB0	Building Services	3	-	-	3	
3.	18CEGC0	Disaster Assessment and Mitigation Measures	3	-	-	3	
4.	18CEGD0	Basics Of ClimateChange	3	-	-	3	
5.	18CEGE0	Road Safety	3	-	-	3	

d. Electives from Foundation Courses - HSS, BS and ES:Credits to be earned 3-6

D. Project : Credits to be earned 15

- 18ES590 - Capstone Design Project (3)
- 18ES690 - Engineering Design Project (3)
- 18CE870 - Project (9)

E. Mandatory Courses (Not included for CGPA)

S.No.	Course Code	Name of the Course	Number of Hours / Week			Credit
			L	T	P	
THEORY						
1.	18CHAA0	Environmental Sciences	2	-	-	0
2.	18CHAB0	Constitution of India	2	-	-	0
THEORY CUM PRACTICAL						
-	-	-	-	-	-	-
PRACTICAL						
-	-	-	-	-	-	-

Minimum credits to be earned for the award of the degree = 160

18MA210	MATRICES AND ORDINARY DIFFERENTIAL EQUATIONS	Category	L	T	P	Credit
		BS	3	0	0	3

Preamble

Engineering, in general, but particularly Solid Mechanics, Aerodynamics, Fluid Flow, Heat Flow and Robotics have application that requires an understanding of Vector Calculus and Differential Equations. Also Mathematical tool Laplace Transforms is very much essential to solve ordinary and partial differential equations that occurs in the above areas. Eigen values and Eigenvectors are extremely important while creating engineering models in control systems, designing bridges, communication systems and searching algorithms. The course is designed to impart the knowledge and understanding of the above concepts to all Engineers and apply them in their areas of specialization.

Prerequisite

18MA110 Engineering Calculus

Course Outcomes

On the successful completion of the course, students will be able to

CO Number	Course Outcome Statement	Weightage in %
CO1	Compute the Laplace transform and inverse Laplace transform of different functions	10
CO2	Solve the given initial value problem using Laplace transform	15
CO3	Apply matrix algebra techniques for transformations of conic sections into principle axes	25
CO4	Solve the model developed for the given system using ordinary differential equation	25
CO5	Compute divergence and curl of vector functions	10
CO6	Apply the concepts of vector differentiation and vector integration to fluid flow and heat transfer problems	15

CO Mapping with CDIO Curriculum Framework

CO's	TCE Proficiency Scale	Learning Domain Level			CDIO Curricular Components
		Cognitive	Affective	Psychomotor	
CO1	TPS2	K2	A2		1.1
CO2	TPS3	K3	A3		1.1
CO3	TPS3	K3	A3		1.1
CO4	TPS3	K3	A3		1.1
CO5	TPS2	K2	A2		1.1
CO6	TPS3	K3	A3		1.1

Mapping with Programme Outcomes

CO's	PO1	PO2	PO3	PO4	PO5	PO6	PO7	PO8	PO9	PO10	PO11	PO12	PSO 1	PSO 2
CO1.	S	M	-	-	-	-	-	-	-	-	-	-	L	-
CO2.	S	S	S		-	-	-	-	M	-	-	M	M	L
CO3.	S	S	-	S	-	-	-	-	-	-	-	S	M	L
CO4.	S	S	S	S	-	-	-	-	M	-	-	M	S	L
CO5.	S	M	-	-	-	-	-	-	-	-	-	-	L	-
CO6.	S	S	S	-	-	-	-	-	-	-	-	-	M	-

S- Strong; M-Medium; L-Low

Assessment Pattern: Cognitive Domain

Cognitive Levels	Continuous Assessment Tests			Assignment			Terminal Examination
	1	2	3	1	2	3	
Remember	10	10	10				10
Understand	30	30	30				20
Apply	60	60	60	100	100	100	70
Analyse	00	00	00				00
Evaluate	00	00	00				00
Create	00	00	00				00

Sample Questions for Course Outcome Assessment****Course Outcome (CO 1):**

- Show that Laplace transforms of $\frac{1}{\sqrt{t}}$ is $\frac{\sqrt{\pi}}{s}$.
- Identify the inverse Laplace transform of $\log\left(\frac{s^2+1}{(s-1)^2}\right)$.
- Discuss any three properties of Laplace transforms.

Course Outcome (CO 2):

- Apply Laplace transform solve $y''+9y = \delta\left(t - \frac{\pi}{2}\right)$, $y(0) = 2$, $y'(0) = 0$.
- By using Laplace transform, solve $x''(t) + 3x'(t) + 2x(t) = 2(t^2 + t + 1)$; with $x(0) = 2$, $x'(0) = 0$.
- Apply convolution theorem, solve the Volterra integral equation of the second kind $y(t) - \int_0^t y(\tau) \sin(t - \tau) d\tau = t$.

Course Outcome (CO 3):

- An elastic membrane in the $x_1 x_2$ plane with boundary circle $x_1^2 + x_2^2 = 1$ is stretched so that a point $P; (x_1, x_2)$ goes over into the point $Q; (y_1, y_2)$ given by

$$y_1 = 5x_1 + 3x_2$$

$$y_2 = 3x_1 + 5x_2$$
 Find the principal directions that is the directions of the position vector X of P for which the direction of the position vector Y of Q is the same or exactly opposite.
 Predict the boundary circle take under this deformation?
- Discover the type of conic section the following quadratic form represents and transform it to principal axes: $Q = 17x_1^2 - 30x_1x_2 + 17x_2^2 = 128$.

3. Diagonalize the matrix $\begin{bmatrix} 6 & 0 & 0 \\ 12 & 2 & 0 \\ 21 & -6 & 9 \end{bmatrix}$

Course Outcome (CO4):

1. Reduce to first order and solve $y''-y'=0$
2. Compute the general solution for $y''+y'+(\pi^2 + 1/4)y = e^{-x/2} \sin \pi x$
3. Solve $(x^2 D^2 - 4xD - 6)y = c$

Course Outcome (CO5):

1. Predict the value of $div(curl \vec{F})$.
2. If ϕ_1 and ϕ_2 are scalar point functions and \vec{F} is a vector point function such that $\phi_1 \vec{F} = \nabla \phi_2$ then identify $\vec{F} \cdot curl \vec{F}$.
3. Estimate $curl \vec{v}$, where $\vec{v} = [e^{-z^2}, e^{-x^2}, e^{-y^2}]$.

Course Outcome (CO6):

1. Predict the work done by the force $\vec{F} = [y^2, -x^2]$ acting on a particle in $y = 4x^2$ from (0,0) to (1,4).
2. Compute the amount of fluid that crosses the surface in a flow per unit time at any one instant, if the velocity field is $\vec{v} = y\vec{i} + x\vec{j} + z\vec{k}$ over the boundary of the region enclosed by the paraboloid $z = 1 - x^2 - y^2$ and the plane $z = 0$.
3. Apply Stokes theorem to compute $\int_C \vec{F} \cdot \vec{r}' ds$ where $\vec{F} = [y, xz^3, -zy^3]$ and C is circle $x^2 + y^2 = 4, z = -3$.

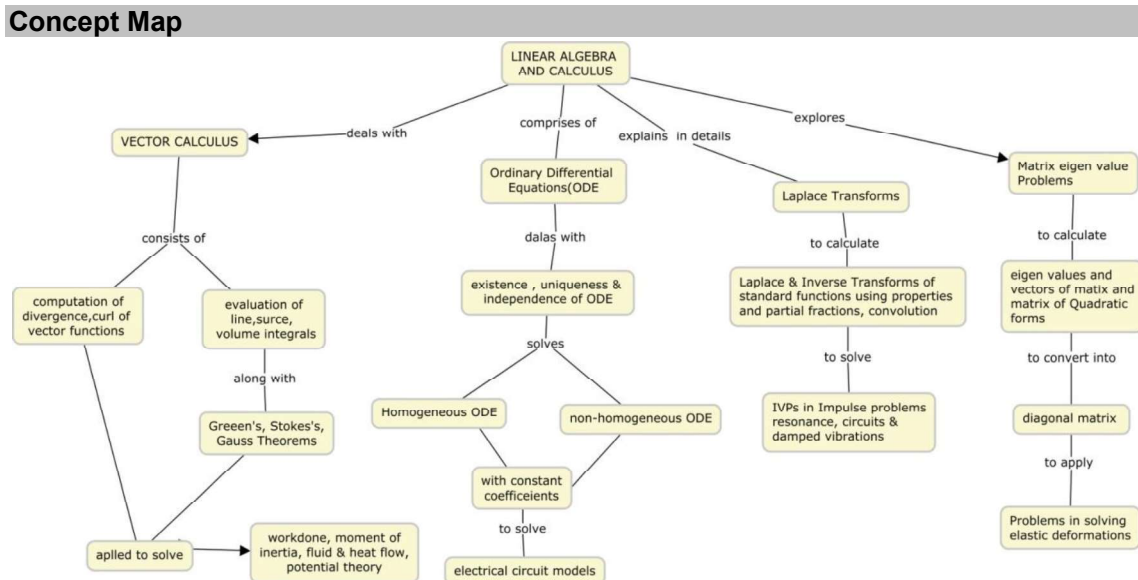

Syllabus

LAPLACE TRANSFORMS

(9 hours)

Laplace transform, Linearity, First Shifting theorem – Transforms of derivatives and integrals, ODEs – Unit step function, Second shifting theorem – Short Impulses, Dirac's delta function, partial fractions – Convolution, Integral Equations – Differentiation and integration of transforms.

MATRIX EIGEN VALUE PROBLEM

(9 hours)

The Matrix Eigen value Problem, Determining Eigenvalues and Eigenvectors – Some Applications of Eigen value Problems – Symmetric, Skew symmetric and orthogonal matrices – Eigen bases, Diagonalization, Quadratic forms.

ORDINARY DIFFERENTIAL EQUATION

(9 hours)

Homogeneous Linear ODEs of second order – Homogeneous Linear ODEs with constant coefficients – Euler Cauchy Equation – Existence and uniqueness of solutions, Wronskian - Nonhomogeneous ODE – Modelling: Electric Circuits- Solution by Variation of Parameters.

VECTOR CALCULUS

(9 hours)

Divergence of a Vector Field- Curl of a Vector Field- Line Integrals- Path independence of line integrals- Green's Theorem in the plane- Surface Integrals- Triple Integrals, Divergence Theorem of Gauss- Applications of the Divergence Theorem- Stoke's Theorem.

Learning Resources

- Erwin Kreszig, "Advanced Engineering Mathematics", 10th edition, Wiley, 2017.
Laplace transforms : [sections 6.1,6.2,6.3,6.4,6.5,6.6]
Matrix eigen value problem : [sections 8.1,8.2,8.3,8.4]
Ordinary differential equations : [sections 2.1,2.2,2.5,2.6,2.7,2.9,2.10]
Vector calculus : [sections 9.8,9.9,10.1,10.2,10.4,10.6, 10.7,10.8,10.9]
- Peter V.O'Neil, "Advanced Engineering Mathematics", 7th edition, Cengage Learning, 2017.
- Glyn James, "Advanced Modern Engineering Mathematics", Pearson Education, New Delhi, 2016.
- Jain R.K. and Iyengar S.R.K., "Advanced Engineering Mathematics", Narosa Publications, New Delhi, 3rd Edition, 2007.
- Made Easy Team, Engineering Mathematics, Made Easy Publications, 2018.

Course Contents and Lecture Schedule

Module No.	Topic	No. Of Hours	Course Outcome
1.	LAPLACE TRANSFORMS		
1.1	Laplace Transform. Linearity. First Shifting Theorem (<i>s</i> -Shifting)	2	CO1
1.2	Transforms of Derivatives and Integrals. ODEs	2	CO2
1.3	Unit Step Function (Heaviside Function). Second Shifting Theorem (<i>t</i> -Shifting)	1	CO1

1.4	Short Impulses. Dirac's Delta Function. Partial Fractions	1	
1.5	Convolution. Integral Equations	2	CO2
1.6	Differentiation and integration of transforms	1	CO1
2	MATRICES EIGEN VALUE PROBLEMS		
2.1	Determining Eigenvalues and Eigenvectors	2	CO3
2.2	Some Applications of Eigenvalue Problems	1	
2.3	Symmetric, Skew-Symmetric, and Orthogonal Matrices	2	
2.4	Eigenbases. Diagonalization.	2	
2.5	Quadratic Forms	2	
3	ORDINARY DIFFERENTIAL EQUATION		
3.1	Homogeneous Linear ODEs of Second Order	2	CO4
3.2	Homogeneous Linear ODEs with Constant Coefficients	1	
3.3	Euler–Cauchy Equations	1	
3.4	Existence and Uniqueness of Solutions. Wronskian	1	
3.5	Nonhomogeneous ODEs	2	
3.6	Solution by Variation of Parameters	2	
4	VECTOR CALCULUS		
4.1	Divergence and Curl of a Vector Field	2	CO5
4.2	Line Integrals	2	CO6
4.3	Green's Theorem in the Plane	1	
4.4	Surface Integrals	1	
4.5	Triple Integrals. Divergence Theorem of Gauss	1	
4.6	Applications of the Divergence Theorem	1	
4.7	Stoke's Theorem	1	
	TOTAL No. of Hours	36	

Course Designers

1. Dr.V.Gnanaraj - vgmat@tce.edu
2. Dr.S.Jeyabharathi - sjbmat@tce.edu
3. Dr.G.Jothilakshmi - gjimat@tce.edu
4. Dr.C.S..Senthil kumar - kumarstays@tce.edu
5. Dr.R.Suresh - suresh080183@tce.edu

18CE220	SURVEYING	Category	L	T	P	Credit
		PC	3	0	0	3

Preamble

Surveying is the process of determining by measurement, the relative positions of points on or near the earth surface. The data collected from survey is used in the preparation of plans, maps, profiles, charts and diagrams. In addition survey may be used for the delineation of property boundaries, computation of areas and volumes also to set out the proposed work on the ground.

Prerequisite

18MA110, 18PHA20

Course Outcomes

On the successful completion of the course students will be able to

CO Number	Course Outcome Statement	Weightage*** in %
CO1	Compute the linear measurements using chains, angular measurements using compass and demonstrate the importance of plane table surveying in preparation of plans and maps.	8
CO2	Find the relative position of points on the ground using leveling principles and compute the areas and volume	25
CO3	Calculate the distance and heights of objects using tacheometric principle (Stadia, Tangential, Trigonometrical and Triangulation)	25
CO4	Compute and setting out different curves on the field.	17
CO5	Explain the importance of advanced techniques and principles involved in surveying such as Total station, GPS, etc.	25

*** Weightage depends on Bloom's Level, number of contact hours,

CO Mapping with CDIO Curriculum Framework

CO's	TCE Proficiency Scale	Learning Domain Level			CDIO Curricular Components (X.Y.Z)
		Cognitive	Affective	Psychomotor	
CO1	TPS2	Understand	Respond	Guided Response	1.1.1, 1.2.1.1, 3.1.1, 3.1.5, 3.2.5
CO2	TPS3	Apply	Value	Mechanism	1.1.1, 1.1.2, 1.2.1.1, 3.1.1, 3.1.5, 3.2.5
CO3	TPS3	Apply	Value	Mechanism	1.1.1, 1.1.2, 1.2.1.1, 3.1.1, 3.1.5, 3.2.5
CO4	TPS3	Apply	Value	Mechanism	1.1.1, 1.1.2, 1.2.1.1, 3.1.1, 3.1.5, 3.2.5
CO5	TPS2	Understand	Respond	Guided Response	1.1.1, 1.1.2, 1.2, 2.5.1, 3.1.1, 3.1.5, 3.2.5,

Mapping with Programme Outcomes and Programme Specific Outcomes

CO's	PO 1	PO 2	PO 3	PO 4	PO 5	PO 6	PO 7	PO 8	PO 9	PO 10	PO 11	PO 12	PSO 1	PSO 2
CO1	M	M	L	-	-	-	-	-	L	L	-	-	L	L

CO2	S	S	L	-	-	-	-	-	L	-	-	-	L	-
CO3	S	S	M	-	-	-	-	-	L	-	-	-	M	-
CO4	S	S	M	L	-	L	-	L	L	L	-	-	M	L
CO5	L	L	L	-	L	-	-	-	-	-	-	-	L	L

S- Strong; M-Medium; L-Low

Assessment Pattern: Cognitive Domain

Cognitive Levels	Continuous Assessment Tests			Assignment			Terminal Examination
	1	2	3	1	2	3	
Remember	20	20	20	-	-	-	20
Understand	20	20	20	-	-	-	20
Apply	60	60	60	100	100	100	60
Analyse	---	---	---	---	---	---	---
Evaluate	---	---	---	---	---	---	---
Create	---	---	---	---	---	---	---

Assessment Pattern: Psychomotor

Psychomotor Skill	Mini-project /Assignment/Practical Component
Perception	--
Set	--
Guided Response	50
Mechanism	50
Complex Overt Responses	---
Adaptation	---
Origination	---

Sample Questions for Course Outcome Assessment**

** (2 to 3 at the cognitive level of course outcome)

Course Outcome 1(CO1):

1. Discuss the various methods of chaining on sloping ground
2. Compare Prismatic compass and surveyors compass
3. Describe the various components of a plane table. What are their functions?

Course Outcome 2(CO2):

1. The following staff readings were observed with level with the instrument having moved forward after the 3rd and 7th reading. 0.875, 1.235, 2.310, 1.385, 2.930, 3.125, 4.125, 0.120, 1.875, 2.030, 3.765. The RL of the first point was 150m. Calculate the RL of other points by rise and fall as well as the height of collimation method. If the distance between the first and last point was 1500 m, find its gradient
2. The following consecutive readings were taken with a level and 4m leveling staff on continuously sloping ground at a common interval of 30m. 3.575, 2.860, 2.235, 1.605, 0.565, 3.870, 2.935, 1.915, 1.235, 0.860, 3.720, 0.565, 2.585, 1.365, 1.025. The RL of the first point was 100 m. (i) Calculate the RL of the points by (a) rise and fall method and (b) height of collimation method. (ii) Find the gradient between first and last point.

3. A series of offsets were taken from a chain line to a curved boundary at intervals of 5m in the following order: 1.75, 2.50, 4.75, 5.85, 3.95, 4.90, 6.55 and 5.25m. Calculate the area enclosed between the survey line, irregular boundary and the first and last offsets, using the Trapezoidal and Simpson's rule.

Course Outcome 3 (CO3):

1. The following observation refers to a tacheometric survey. Compute the reduced levels of P, Q and R and the horizontal distances PQ and QR. Assume the tacheometer fitted with anallatic lens.

Inst Stn	Height of axis	Staff at	Vertical angle	Staff readings			Remarks
				Bottom	Middle	Top	
P	1.440	BM	$-2^{\circ}24'$	1.200	1.830	2.460	RL of BM = 37.725m. Staff being held vertically
P	1.440	Q	$+4^{\circ}36'$	1.350	1.820	2.209	
Q	1.410	R	$+6^{\circ}12'$	0.720	1.880	2.040	

2. Find the elevation of the top of chimney from the following data.

Inst Stn	Reading on BM	Angle of elevation	Remarks
A	0.860	$18^{\circ}36'$	RL of BM=421.380m Distance AB = 50m
B	1.220	$10^{\circ}12'$	

Stations A and B and the top of chimney are in the same vertical plane.

3. Two triangulation stations A and B are 40km apart and have elevations of 178m and 175m respectively. Find the minimum height of signal required at B so that the line of sight may not pass nearer the ground than 3m. The intervening ground may be assumed to have a uniform elevation of 150m.

Course Outcome 4 (CO4):

- Two tangents intersect at chainage 49 + 50, the deflection angle being 40° . Calculate the necessary data for setting out a curve of 15 chain radius to connect the two tangents if it is intended to set out the curve by Rankine's method of tangential angles. Take the length of the chain being 20 m (100 links). Tabulate the actual readings of deflection angles to be set out.
- Calculate the ordinates at 10 m distances for a circular curve having a long chord of 80 m and a versed sine of 4 m.
- Derive the expression for the length and shift of a transition curve required for a first class railway track.

Course Outcome 5(CO5):

- Explain the principle underlying EDM
- State the significance of Total station in the modern methods of surveying
- Describe with sketches the field work of a survey with phototheodolite.

Concept Map

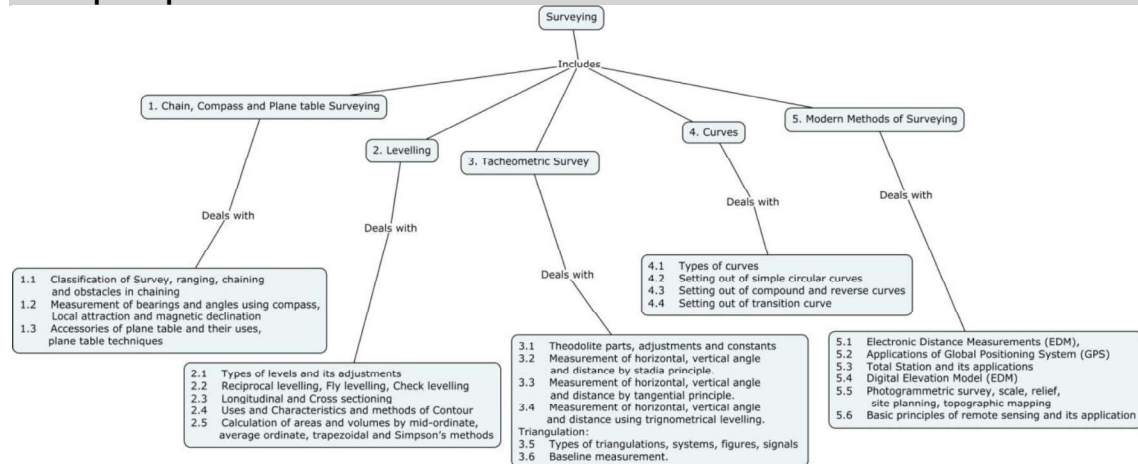

Syllabus

Introduction: Definition, classification of surveys, **Chain surveying:** Ranging and Chaining, obstacles in chaining. **Compass surveying:** Prismatic compass, Magnetic declination, local attraction. **Plane table surveying:** Accessories, plane table techniques. **Levelling:** Types of levels, temporary adjustments of a level, methods of levelling, fly levelling, longitudinal sectioning and cross sectioning, contouring. **Areas and Volumes:** Calculation of areas and volumes by mid-ordinate, average ordinate, trapezoidal and Simpson's methods. **Tacheometric Survey:** Measurement of horizontal and vertical angle, Stadia, tangential and Trigonometrical levelling **Triangulation:** Types of triangulations, systems, figures, signals and baseline measurement. **Curves:** setting out of simple and compound curves. **Modern methods of Surveying:** Electronic Distance Measurement (EDM), Global Positioning System (GPS), Total station and its application. Digital Elevation Model (DEM). Photogrammetric survey. Basic principles of remote sensing and its application.

Learning Resources

1. Punmia, B.C, Ashok K Jain and Arun K Jain, " Surveying" Vol. I&II, Laxmi Publication, 17th Edition, New Delhi, 2016.
2. Kanetkar, T.P, and Kulkarni, S.V, "Surveying and Levelling" Vol. I&II, Pune Vidyarthi Griha Prakashan, 24th Revised Edition, Pune, 2010.
3. Venkatramaiah C, "Textbook of Surveying", University Press, 2nd Edition, Hyderabad, 2011.
4. <https://nptel.ac.in/courses/105104101/1>

Course Contents and Lecture Schedule

Module No.	Topic	No. of Hours	Course Outcome
1.	Chain, Compass and Plane table Surveying		
1.1	Classification of Survey, ranging, chaining and obstacles in chaining	1	CO1
1.2	Measurement of bearings and angles using compass, Local attraction and magnetic declination	1	
1.3	Accessories of plane table and their uses, plane table	1	

	techniques		
2	Levelling		
2.1	Types of levels and its adjustments	1	CO2
2.2	Reciprocal levelling, Fly levelling, Check levelling	2	
2.3	Longitudinal and Cross sectioning	2	
2.4	Uses and Characteristics and methods of Contour	2	
2.5	Calculation of areas and volumes by mid-ordinate, average ordinate, trapezoidal and Simpson's methods	2	
3	Tacheometric Survey		
3.1	Theodolite parts, adjustments and constants	1	CO3
3.2	Measurement of horizontal, vertical angle and distance by stadia principle.	2	
3.3	Measurement of horizontal, vertical angle and distance by tangential principle.	1	
3.4	Measurement of horizontal, vertical angle and distance using trigonometrical levelling.	2	
	Triangulation:		
3.5	Types of triangulations, systems, figures, signals	2	
3.6	Baseline measurement.	1	
4	Curves		
4.1	Types of curves	1	CO4
4.2	Setting out of simple circular curves	1	
4.3	Setting out of compound and reverse curves	2	
4.4	Setting out of transition curve	2	
5	Modern Methods of Surveying		
5.1	Electronic Distance Measurements (EDM),	1	CO5
5.2	Applications of Global Positioning System (GPS)	1	
5.3	Total Station and its applications	2	
5.4	Digital Elevation Model (EDM)	1	
5.5	Photogrammetric survey, scale, relief, site planning, topographic mapping	2	
5.6	Basic principles of remote sensing and its application	2	
Total Hours		36	

Course Designers:

1. Dr. K. Sudalaimani ksudaliamani@tce.edu
2. Dr. T. Baskaran tbciv@tce.edu
3. Mr. A.Rajasekar rajasekara@tce.edu

18CE230	ENGINEERING MECHANICS	Category	L	T	P	Credit
		ES	2	1	0	3

Preamble

A structure is made up of constituent elements like beam, column and membrane. The constituent elements should have adequate size to resist applied loads to build a safe structure. Their size is decided by material properties of the elements, particularly their strength. Fields like fracture mechanics, stress concentration, ductility, strength theories, fatigue, experimental stress analysis are few among a vast horde of new fields of study that have emerged from a renewed interest in Strength of Materials in twentieth century.

Prerequisite

Basic Concepts of Physics and Mathematics

Course Outcomes

On the successful completion of the course students will be able to

CO Number	Course Outcome Statement	Weightage*** in %
CO1	Solve practical problems through evaluating the laws of mechanics and also to apply equilibrium concepts	17
CO2	Compute geometric properties of sections	14
CO3	Understand and apply the concept of stress and strain to solve structural mechanics problem	25
CO4	Practice shear force and bending moment computations and construct shear force and bending moment diagrams	27
CO5	Interpretation of bending and shear stresses for various sections	17

*** Weightage depends on Bloom's Level, number of contact hours,

CO Mapping with CDIO Curriculum Framework

CO's	TCE Proficiency Scale	Learning Domain Level			CDIO Curricular Components (X.Y.Z)
		Cognitive	Affective	Psychomotor	
CO1	TPS2	Understand	Respond	Guided Response	1.1.1,1.1.2,
CO2	TPS2	Understand	Respond	Guided Response	1.1.1,1.1.2,2.1.1,2.1.5,
CO3	TPS3	Apply	Value	Mechanism	2.1.1,2.1.5,2.4.1,2.4.3,2.4.4,
CO4	TPS3	Apply	Value	Mechanism	2.1.1,2.1.5,2.4.1,2.4.3,2.4.4,3.2.5,
CO5	TPS3	Apply	Value	Mechanism	2.1.1,2.1.5,2.4.1,2.4.3,2.4.4,3.2.5,

Mapping with Programme Outcomes and Programme Specific Outcomes

CO's	PO 1	PO 2	PO 3	PO 4	PO 5	PO 6	PO 7	PO 8	PO 9	PO 10	PO 11	PO 12	PSO 1	PSO 2
CO1	M	M	M	-	-	-	-	S	-	-	-	-	M	L

CO2	S	S	S	S	-	M	-	-	-	-	-	-	M	L
CO3	S	S	S	M	-	-	-	-	-	-	-	-	M	L
CO4	S	S	S	S	-	M	-	S	-	-	-	-	M	L
CO5	L	L	L	-	-	-	-	-	-	-	-	-	L	L

S- Strong; M-Medium; L-Low

Assessment Pattern: Cognitive Domain

Cognitive Levels	Continuous Assessment Tests			Assignment			Terminal Examination
	1	2	3	1	2	3	
Remember	10	10	10	-	-	-	10
Understand	10	10	10	-	-	-	10
Apply	80	80	80	100	100	100	80
Analyse							
Evaluate							
Create							

Assessment Pattern: Psychomotor

Psychomotor Skill	Assignment
Perception	-
Set	50
Guided Response	50
Mechanism	-
Complex Overt Responses	-
Adaptation	-
Origination	-

Sample Questions for Course Outcome Assessment**

Course Outcome 1(CO1):

- Determine the magnitude and direction of resultant of the following two forces acting on a bolt. One force is of magnitude 10kN making an angle of 60° with the horizontal axis and pointed right side up and another force of magnitude 15kN making an angle 30° with the horizontal axis and pointed right side down.
- Obtain the components of a 5kN force forming angles of 40° , 60° and 110° respectively with x,y and z axes
- Three forces equal to 3P, 5P and 7P act simultaneously along the three sides AB, BC, and CA of an equilateral triangle ABC of side a. Calculate the magnitude, direction and position of the resultant once.

Course Outcome 2(CO2):

- A unsymmetrical I section is having top flange of size 100mm x 25mm, web of size 20mm x 200mm and bottom flange of size 125mm x 25mm. Compute the moments of inertia about xx and yy axes. Also, determine the radius of gyration.
- A channel section 300 mm x 10 mm is 20 mm thick. Calculate the centre of gravity of the section from the back of the web.
- A uniform lamina shown in Fig.1 consists of a rectangle, a circle and triangle. Determine the centre of gravity of the lamina.

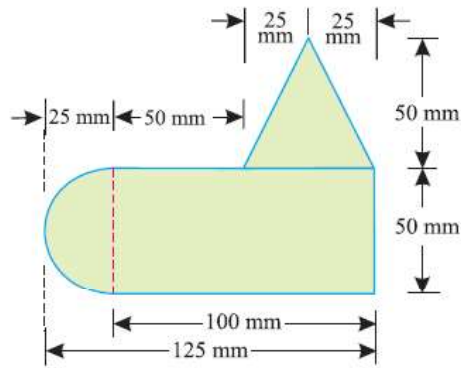

Fig.1

Course Outcome 3(CO3):

1. A circular rod of 100mm diameter and 500mm length is subjected to an axial force of 2000kN. Determine the modulus of rigidity, Bulk modulus and the change in volume if the Poisson's ratio is 0.30 and Young's modulus is 200GPa.
2. A bar of 20mm diameter is tested in tension. It is observed that when a load of 40kN is applied, the extension measured over a gauge length of 200mm is 0.15mm and contraction in diameter is 0.004mm. Find the Poisson's ratio and the elastic constants.
3. At a certain point in a strained material, the stresses on the two planes at right angles to each other are 40N/mm^2 and 20N/mm^2 both tensile. They are accompanied by a shear stress of magnitude 20N/mm^2 . Determine graphically the location of principal planes and evaluate the principal stresses.

Course Outcome 4 (CO4):

1. A simply supported beam of span 6m is subjected to two point loads of 15kN and 20kN at 2m and 4m from left end. Draw the shear force and bending moment diagrams.
2. A cantilever beam of span 6m is subjected to a point load of 10kN at free end. Draw the shear force and bending moment diagrams.
3. Draw shear force and bending moment diagrams for the simply supported beam shown in Fig.2 and indicating values at salient points.

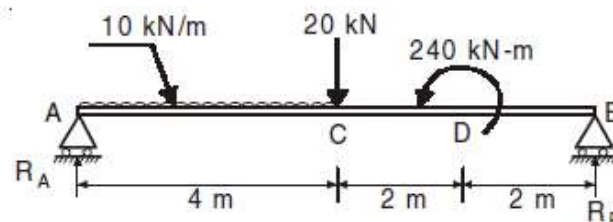
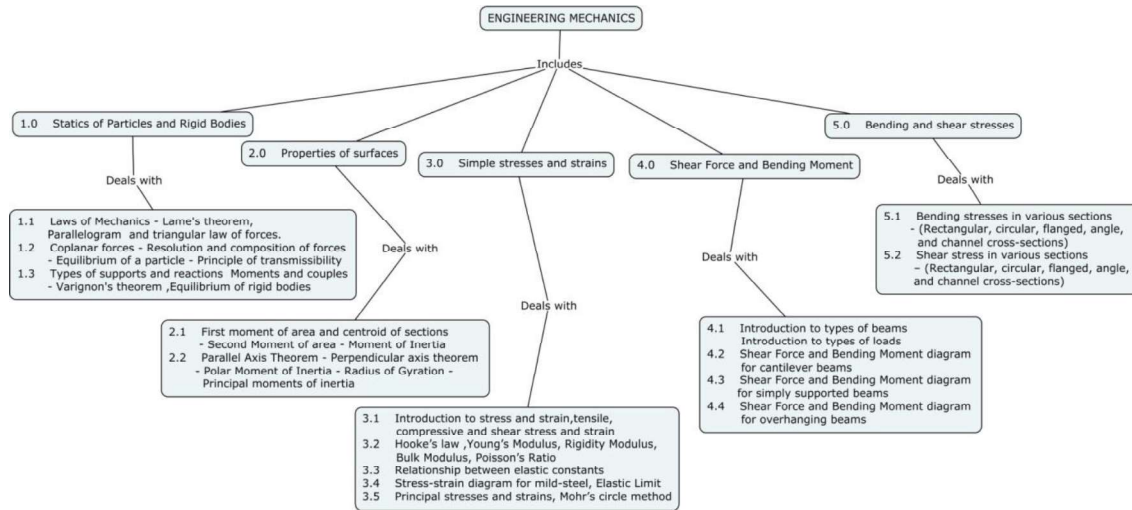

Fig.2

Course Outcome 5 (CO5):

1. A T-beam having flange dimensions 150mm x 50mm and web dimensions 50mm x 150mm is simply supported over a span of 4m and carries a uniformly distributed load of 2 kN/m over the entire span. Determine the maximum tensile and maximum compressive stress. Also, sketch the bending stress distribution across the cross section
2. A timber beam is simply supported at its ends and carries a concentrated load at the mid span. The maximum longitudinal stress is 'f' and the maximum shearing stress is q. Find the ratio of the span to depth of the beam ignoring the self-weight of the beam. If $f = 12\text{ MPa}$ and $q = 1\text{ MPa}$.
3. A simply supported beam of span 5m has a cross section 150mm x 250mm. If the permissible bending stress is 10N/mm^2 , calculate (i) Maximum intensity of uniformly distributed load it can carry. (ii) Maximum concentrated load P applied at 2m from left end it can carry.

Concept Map



Syllabus

Statics of Particles and Rigid Bodies; Laws of Mechanics - Lamé's theorem, Parallelogram and triangular law of forces - Coplanar forces - Resolution and composition of forces - Equilibrium of a particle - Principle of transmissibility. Types of supports and reactions - Requirements of stable equilibrium - Moments and couples - Varignon's theorem - Equilibrium of rigid bodies. **Properties of surfaces:** First moment of area and centroid of sections - Second Moment of area - Moment of Inertia - Parallel Axis Theorem - Perpendicular axis theorem - Polar Moment of Inertia - Radius of Gyration - Principal moments of inertia. **Simple Stresses and Strains :** Introduction, stress, strain, tensile, compressive and shear stress – Hooke’s law – Young’s modulus, rigidity modulus, Bulk modulus, Poisson’s ratio, Volumetric strain, relationship between elastic constants. **Principal stresses and strains:** Analysis of plane stress and strain, principal stresses and strains – Mohr’s circle. **Shear Force and Bending Moment:** Introduction, types of beams – cantilever, simply supported over hanging, fixed and continuous beams. Types of loads – concentrated load, uniformly distribute load, uniformly varying load and couples. Shear force and bending moment diagram for statically determinate beams (cantilever, simply supported and over hanging). **Bending and shear stresses:** bending stresses, shear stresses in various sections.

Learning Resources

1. Timoshenko. S.P. and Young D.H., “Elements of Strength of Materials”, 5th edition (SI Units), Affiliated East-West Press Ltd., New Delhi, 2012.
2. Ferdinand P. Beer and E. Russell Johnston Jr, “Mechanics of Materials”, McGraw Hill Book Company, Singapore, 1992.
3. Egor. P. Popov, “Mechanics of Materials”, Prentice Hall, 1976.
4. <https://nptel.ac.in/courses/105105108/>

Course Contents and Lecture Schedule

Module No.	Topic	No. of Lectures	Course Outcome
1.0	Statics of Particles and Rigid Bodies		
1.1	Laws of Mechanics - Lamé's theorem, Parallelogram and triangular law of forces.	1	

1.2	Coplanar forces - Resolution and composition of forces - Equilibrium of a particle - Principle of transmissibility	1	CO1
	Tutorial	1	
1.3	Types of supports and reactions - Requirements of stable equilibrium - Moments and couples - Varignon's theorem - Equilibrium of rigid bodies	2	
	Tutorial	1	
2.0	Properties of surfaces		CO2
2.1	First moment of area and centroid of sections - Second Moment of area - Moment of Inertia	1	
	Tutorial	1	
2.2	Parallel Axis Theorem - Perpendicular axis theorem - Polar Moment of Inertia - Radius of Gyration - Principal moments of inertia	2	
	Tutorial	1	CO3
3.0	Simple stresses and strains		
3.1	Introduction to stress and strain, tensile, compressive and shear stress and strain	1	
3.2	Hooke's law, Young's Modulus, Rigidity Modulus, Bulk Modulus, Poisson's Ratio	1	
	Tutorial	1	
3.3	Relationship between elastic constants	2	
3.4	Stress-strain diagram for mild-steel, Elastic Limit	1	
	Tutorial	1	
3.5	Principal stresses and strains, Mohr's circle method	1	CO4
	Tutorial	1	
4.0	Shear Force and Bending Moment		
4.1	Introduction to types of beams – Cantilever, Simply Supported, Overhanging, Fixed and, Continuous Beams Introduction to types of loads - Concentrated Load, Uniformly Distributed Load, Uniformly Varying Load, Couples	1	
4.2	Shear Force and Bending Moment diagram for cantilever beams	2	
	Tutorial	1	
4.3	Shear Force and Bending Moment diagram for simply supported beams	2	
	Tutorial	1	
4.4	Shear Force and Bending Moment diagram for overhanging beams	2	CO5
	Tutorial	1	
5.0	Bending and shear stresses		
5.1	Bending stresses in various sections - (Rectangular, circular, flanged, angle, and channel cross-sections)	2	
	Tutorial	1	
5.2	Shear stress in various sections – (Rectangular, circular, flanged, angle, and channel cross-sections)	2	CO5
	Tutorial	1	
Total Hours(24 Theory + 12 Tutorials)		36	

Course Designers:

1. Dr. S. Nagan nagan_civil@tce.edu
2. Mr.R.Indrajith Krishnan jith@tce.edu
3. Mr.R.Sankaranarayanan rsciv@tce.edu

18CE260	BUILDING MATERIALS AND TECHNOLOGY	Category	L	T	P	Credit
		PC	2	0	2	3

Preamble

This theory cum practical course is designed to give an exposure on the theoretical concepts of various materials and techniques in construction. It also gives an overview on planning aspects of residential building components with ventilation as per NBC provisions. This course also aims to apply the theoretical knowledge to practical problems.

Prerequisite

Nil

Course Outcomes

On the successful completion of the course, students will be able to:

CO Number	Course Outcome Statement	Weightage in %
CO1	Apply NBC provisions and plan components of residential buildings for the given plot sizes as per NBC along with ventilation aspects	20
CO2	Explain the properties and uses of various building materials, conduct tests on materials such as bricks, steel, cement and select suitable material for an given applications	20
CO3	Explain the components of building in sub – structure and super structure. Also identify, describe and demonstrate the techniques used for their construction	35
CO4	Identify and describe the salient features and uses of various flat and pitched roofs, weathering course, Floor, flooring pointing, plastering, painting including scaffolding, shoring and underpinning	18
CO5	Select appropriate tools and equipment for testing of materials such as: bricks, cement and steel rods and construction	7

CO Mapping with CDIO Curriculum Framework

CO's	TCE Proficiency Scale	Learning Domain Level			CDIO Curricular Components (X.Y.Z)
		Cognitive	Affective	Psychomotor	
CO1	TPS3	Apply	Value	Mechanism	1.1.1, 1.2, 2.1.1, 3.1.1
CO2	TPS3	Apply	Value	Mechanism	1.1.1, 1.1.2, 1.2, 2.3.1
CO3	TPS3	Apply	Value	Mechanism	1.1.1, 1.1.2, 1.2, 2.3.1
CO4	TPS3	Apply	Value	Mechanism	1.1.1, 1.1.2, 1.2, 2.3.1
CO5	TPS3	Apply	Value	Mechanism	1.1.2, 1.2

Mapping with Programme Outcomes and Programme Specific Outcomes

COs	PO1	PO2	PO3	PO4	PO5	PO6	PO7	PO8	PO9	PO10	PO11	PO12	PSO1	PSO2
CO7.	S	M	S	-	-	M	M	M	S	S	M	S	M	M
CO8.	S	L	M	-	-	M	S	M	M	M	L	S	M	M
CO3	M	L	M	-	-	S	M	S	S	M	L	S	M	S
CO4	M	L	M	-	-	S	M	S	S	M	L	S	M	S
CO5	L	-	M	-	-	M	-	L	L	L	-	M	L	L

S- Strong; M-Medium; L-Low

Assessment Pattern: Cognitive Domain

Cognitive Levels	Continuous Assessment Tests		Model Examination	Practical Component/ Observation	Terminal Examination
	1	2			
Remember	10	10	0	0	10
Understand	30	20	0	20	30
Apply	60	70	100	80	60
Analyse	0	0	0	0	0
Evaluate	0	0	0	0	0
Create	0	0	0	0	0

Assessment Pattern: Psychomotor

Psychomotor Skill	Mini-project /Practical Component/Observation
Perception	-
Set	10
Guided Response	30
Mechanism	60
Complex Overt Responses	-
Adaptation	-
Origination	-

Course Level Assessment Questions**Course Outcome 1 (CO1)**

1. Plan suitably a residential building of 300sq.m with kitchen, bedroom, living room and bath & water closet to derive max benefit from natural agencies.
2. A hall in a residential building is having dimension of 6m x 5m. Provide suitable openings to cater to the ventilation requirements for the room as per codal provisions.

Course Outcome 2 (CO2)

1. As a civil engineer what parameters you will consider for recommending stone and brick as a building material
2. Assume you are a site engineer, identify measures for protecting cement

Course Outcome 3 (CO3)

1. Draw the cross section through a wall in a building. Identify the various components at different level, mentioning its functions
2. Identify a suitable type of bond in brick masonry for the following cases mentioning its features:
 - i) Partition wall
 - ii) Load bearing wall for 3 storey building
3. Identify a suitable type of stone masonry for the following cases mentioning its features:
 - i) Basement wall
 - ii) Super structure wall

Course Outcome 4 (CO4)

1. Identify a suitable type of floor for the following cases mentioning its features:
 - i) Flooring in Industrial workshop
 - ii) IT building
2. Vertical expansion is required in a multi-storey building. Identify suitable supporting system required for construction activities without affecting the free space surrounding the building

3. A wide opening is to be made in a solid load bearing wall. Identify a suitable technology for executing it, without affecting the safety of the structure

Course Outcome 5 (CO5)

1. Identify suitable equipment to be used for the following situations:
 - i) concreting with minimum voids
 - ii) to maintain verticality in masonry
2. Match suitable equipment with the given applications:

Name of tool/equipment	Application
Spirit level	Mass Concreting
Bulldozer	Proportioning of ingredients in concreting
Needle vibrator	Maintaining horizontality in walls
Mason's square	Maintaining verticality in walls
Batching plant	Compacting concrete in beams
	Compacting concrete in slabs
	Levelling of ground
	Earthwork excavation
	To maintain perpendicularity between walls at corner

Concept Map

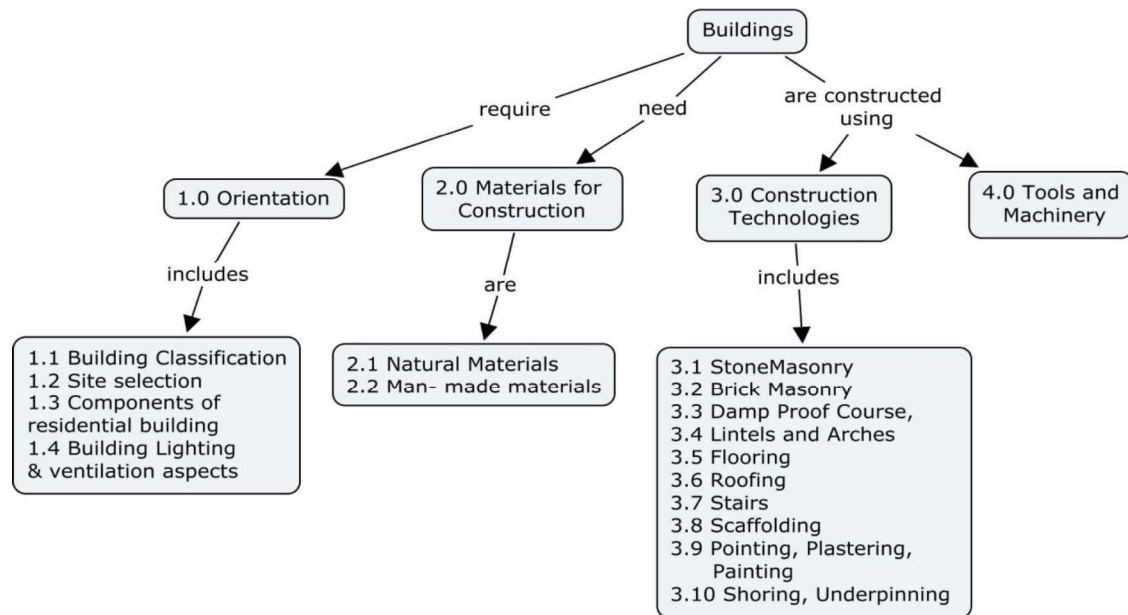

Syllabus

Orientation of Buildings: Classification of buildings as per NBC. Site selection and its influencing factors, National Building Codal provisions for components of residential buildings: Open spaces, Living room, Bed room, Kitchen, Bathroom and Water closet, National Building Codal provisions for ventilation aspects in buildings. NBC provisions for fire safety in buildings. **Materials for Construction:** Natural materials- stones, aggregates, timber, lime. Man- made materials: bricks, cement, steel, concrete, plastics, flyash, GGBS, Silica fume, PCC and RCC. **Technologies of Construction:** Masonry- Stone and Brick, Damp Proof Course, Lintels and Arches, Flooring, Roofing, Stairs, Scaffolding, Pointing, Plastering, Painting, Special Construction Techniques: Shoring,

Underpinning. **Construction Tools and Machinery: Tools:** plumb bob, spirit level, level tube, rammer, spade, shovels, straight edge, mortar pans, sieves, trolley, vibrators, bulldozers, draglines, cableways, belt conveyors. **Machinery:** batching plants, transit mixers and vibratory trucks for ready mixed concrete, pumps, air compressors, hoists and cranes, Choice of construction equipments for different types of works.

Text Book

1. Punmia B.C., Ashok Kumar Jain, Arun Kumar Jain, "Building Construction", Laxmi Publications Pvt. Ltd., 2012

Reference Books

1. Rangwala S.C., "Engineering Materials" Charotar Publishing House, Anand, India, 2014
2. Deodhar S.V., "Construction Equipment and Job Planning", Khanna Publishers, New Delhi, 2014
3. Surendra Singh, "Building Materials", Vikas Publishing Company, New Delhi, 1996
4. Bindra and Arora, "Building Materials and Construction", Dhanpat Rai & Sons, New Delhi, 1998
5. National Building Code of India, Bureau of Indian Standards, 2016
6. Peurifoy. R. L, "Construction Planning, Equipment and Methods", McGraw Hill Co., New York, 2010

Course Contents and Lecture Schedule

Module No	Topic	No. of Hours	Course Outcome
1.0	Orientation		
1.1	Orientation and Classification of Buildings as per NBC	2	CO1
1.2	Site selection and its influencing factor	1	
1.3	National Building Codal provisions for components of residential buildings: Open spaces, Living room, Bed room, Kitchen, Bathroom and Water closet	2	
1.4	Building Ventilation aspects	1	
2.0	Materials for Construction		
2.1	Natural materials - Stones, timber, lime, aggregates – properties and uses	2	CO2
2.2	Man made materials- Bricks, cement, concrete, steel, plastics, flyash, GGBS, silica fume, PCC and RCC	2	
3.0	Components of building & Technologies for Construction		
3.1	a) Components of Building	1	CO3
	b) Stone Masonry	1	
3.2	Brick Masonry	2	
3.3	Damp proof course	1	
3.4	Lintel and Arches	1	
3.5	Flooring	1	CO3,CO4
3.6	Roofing	1	
3.7	Stairs	2	CO4
3.8	Scaffolding	1	
3.9	Pointing, Plastering and Painting	1	
3.10	Shoring and Underpinning	1	

4.0	Construction Tools and Machinery		
4.1	Tools: plumb bob, spirit level, level tube, rammer, spade, shovels, straight edge, mortar pans, sieves, trolley	1	CO5
4.2	Machinery: batching plants, transit mixers and vibratory trucks for ready mixed concrete, hoists and cranes		
Total No. of Lecture Hours		24	

List of Experiments for Practical Hours

S. No	Description	No. of Hours	Course Outcome
1.	Apply NBC provisions and plan components of residential buildings for the given plot size	4	CO1
2.	Demonstrate the Appropriate tools and equipments used for testing materials such as Bricks, steel and cement	2	CO5
3.	Tests on bricks (Field test, Compression and water absorption test)	2	CO2
4.	Demonstrate different types bonds in brick masonry work – Stretcher bond, header bond and English bond	2	CO3
5.	Demonstrate different types bonds in brick masonry work – Flemish bond and zig zag bond	2	CO3
6.	Test on steel (Diameter and tensile strength)	2	CO2
7.	Test on cement (Field test, Consistency and initial setting time)	2	CO2
8.	Identify and classify the different types of stone masonry in the campus	2	CO3
9.	a) Identify and classify the different types of staircases in the campus	1	CO3
	b) Determine the geometrical parameters of dog legged stair	1	
10	Identify and classify the different types of roofs provided in the campus discussing its features	2	CO4
11	Identify and classify the different types of floors and finishes provided in the campus discussing its features	2	CO4
Total Hours		24	

Course Designers:

1. Dr.G.Chitra gcciv@tce.edu
2. Mr.S.Kannan erkannan@tce.edu
3. Mr. D. Rajkumar rajkumarcivil@tce.edu

18CE270	SURVEY LAB	Category	L	T	P	Credit
		PC	0	0	2	1

Preamble

The theory part of Surveying can be experimented in Survey lab I. This includes the experiments on chains, compass, plane table, levels, Theodolite and Total station.

Prerequisite

18MA110, 18PHA20, 18CE220

Course Outcomes

On the successful completion of the course students will be able to

CO Number	Course Outcome Statement	Weightage*** in %
CO1	Use the fundamental survey equipments in the field like chains, compass and plane table.	8
CO2	Locate the elevation of points and plot LS and CS of the given terrain using levels	25
CO3	Find the heights and distances of the objects in the field by stadia, tangential and trigonometrical levelling	50
CO4	Find the heights and distances of the objects in the field using Total station	17

*** Weightage depends on Bloom's Level, number of contact hours,

CO Mapping with CDIO Curriculum Framework

CO's	TCE Proficiency Scale	Learning Domain Level			CDIO Curricular Components (X.Y.Z)
		Cognitive	Affective	Psychomotor	
CO1	TPS2	Understand	Respond	Guided Response	1.1.1, 1.1.2, 1.2, 3.1.1,3.1.5, 3.2.5,
CO2	TPS3	Apply	Value	Mechanism	1.1.1, 2.1.1, 2.1.3, 2.1.5, 3.1.1, 3.1.2, 3.1.5, 3.2.5
CO3	TPS3	Apply	Value	Mechanism	1.1.1, 1.1.2, 2.1.1, 3.1.1, 3.1.5, 3.2.5
CO4	TPS3	Apply	Value	Mechanism	1.1.1, 2.1.1,2.1.3, 2.2.3,2.4.2, 3.1.1, 3.1.5, 3.2.5

Mapping with Programme Outcomes and Programme Specific Outcomes

Cos	PO 1	PO 2	PO 3	PO 4	PO 5	PO 6	PO 7	PO 8	PO 9	PO 10	PO 11	PO 12	PSO 1	PSO 2
CO1	S	L	L	S	-	S	-	S	-	L	-	-	M	L
CO2	S	S	S	S	-	-	-	S	-	L	-	-	M	L
CO3	S	S	S	S	-	S	-	-	-	L	-	-	M	L
CO4	S	S	S	S	-	S	-	-	-	L	-	-	M	L

S- Strong; M-Medium; L-Low

Assessment Pattern: Cognitive Domain

Cognitive Levels	Model Examination	Terminal Examination
Remember	--	--
Understand	10	10
Apply	90	90

Analyse	--	--
Evaluate	--	--
Create	--	--

Assessment Pattern: Psychomotor

Psychomotor Skill	Mini-project /Practical Component/Observation
Perception	--
Set	--
Guided Response	50
Mechanism	50
Complex Overt Responses	--
Adaptation	--
Orignation	--

List of Experiments/Activities with CO Mapping

S.No	Description	No of Hours	Course Outcome
1.	Ranging and Chaining, Measurement of bearings using compass and application of Plane table	2	CO1
2.	Find the difference in elevation between the two points by differential levelling.	2	CO2
3.	Find the elevation of the given points by running fly Levelling	2	
4.	Determine the profile of the ground by profile levelling and Cross-section levelling	2	
5.	Find the height and distance of the objects in the field by stadia method of survey	4	CO3
6.	Find the height and distance of the objects in the field by tangential method of survey	4	
7.	Find the height and distance of the objects in the field by trigonometric method of survey	4	
8.	Find the height and distance of the objects in the field using total station.	4	CO4
Total Hours		24	

Course Designers:

1. Dr. K. Sudalaimani ksudaliamani@tce.edu
2. Dr. T. Baskaran tbciv@tce.edu
3. Mr. A.Rajasekar rajasekara@tce.edu

18CE280	WORKSHOP	Category	L	T	P	Credit
		PC	0	0	2	1

Preamble

Workshop is a hands-on training practice to Mechanical and Civil engineering students. It deals with fitting, carpentry, sheet metal and related exercises. Also, it will induce the habit of selecting right tools, planning the job and its execution.

Prerequisite

NIL

Course Outcomes

On the successful completion of the course students will be able to

CO Number	Course Outcome Statement	Weightage*** in %
CO1	Construct various regular solid models with card board	10
CO2	Make different types of Mild Steel plate joints using fitting operations.	30
CO3	Fabricate sheet metal components.	30
CO4	Make different types of wooden joints.	30

*** Weightage depends on Bloom's Level, number of contact hours

CO Mapping with CDIO Curriculum Framework

CO #	TCE Proficiency Scale	Learning Domain Level			CDIO Curricular Components (X.Y.Z)
		Cognitive	Affective	Psychomotor	
CO1	TPS 3	Apply	Value	Mechanism	1.2, 2.1.2, 3.1, 4.4.2
CO2	TPS 3	Apply	Value	Mechanism	1.2, 2.1.2, 3.1, 4.4.2
CO3	TPS 3	Apply	Value	Mechanism	1.2, 2.1.2, 3.1, 4.4.2
CO4	TPS 3	Apply	Value	Mechanism	1.2, 2.1.2, 3.1, 4.4.2

Mapping with Programme Outcomes and Programme Specific Outcomes

COs	PO 1	PO 2	PO 3	PO 4	PO 5	PO 6	PO 7	PO 8	PO 9	PO 10	PO 11	PO 12	PSO 1	PSO 2
CO1	S	M	L	L	L	—	—	—	S	—	—	—	M	L
CO2	S	M	L	L	L	—	—	—	S	—	—	—	M	L
CO3	S	M	L	L	L	—	—	—	S	—	—	—	M	L
CO4	S	M	L	L	L	—	—	—	S	—	—	—	M	L

S- Strong; M-Medium; L-Low

Assessment Pattern: Cognitive Domain

Trade	Observation/Viva	Record	Continuous Assessment	Total Marks
Card Board Exercises	20	10	20	50
Fitting				
Sheet Metal				
Carpentry				

NOTE:

- Terminal examination will be conducted for Maximum of 100 Marks.
- Students will be evaluated in any of the two trades, each of 1½ hours duration.

Assessment Pattern: Psychomotor

Psychomotor Skill	Mini project / Practical Component /Observation
Perception	
Set	
Guided Response	
Mechanism	All Practical Component
Complex Overt Responses	
Adaptation	
Origination	

Syllabus with CO Mapping

- CO1 Card Board Exercises (2 Hours)**
 Construction of cube/Triangular/square/Pentagonal/Hexagonal Prisms (Any ONE solid)
 Construction of Triangular/square/Pentagonal/Hexagonal Pyramids (Any ONE solid)
- CO2 Fitting Exercises (6 Hours)**
 Preparation of Square/V/L/Gauge/Taper/Radius/Dove Tail Fitting (Any TWO Fitting Exercises)
- CO3 Sheet Metal Exercises (8 Hours)**
 Preparation of Litre Cone/Dust pan (Straight, Taper)/Tray (Straight, Taper) - (Any ONE sheet metal Exercise)
- CO4 Carpentry Exercises (6 Hours)**
 Preparation of wooden parts like Door frame/Office tray (Any ONE Carpentry Exercise)
 Demonstration of plumbing pipe line circuit for domestic application. (2 Hours)

Number of exercise is to be completed

1. Card board exercises - 2 Nos.
2. Fitting Exercises - 2 Nos.
3. Sheet metal Exercises - 1 No.
4. Carpentry Exercises - 1 No.

5. Demonstration on plumbing - 1 No.

Learning Resources

1. John K.C “Mechanical Workshop”, Practice by Prentice Hall India Learning Private Limited, Second edition, 2010.

Course Designers

1. Dr.C.Paramasivam cpmect@tce.edu
2. M.Karthic mkmect@tce.edu
3. M.Karthic mkmect@tce.edu

18ES290	LATERAL THINKING	Category	L	T	P	Credit
		ES	0	0	2	1

Preamble

The purpose of thinking is to collect information and to make the best possible use of it. Vertical thinking is concerned with proving or developing concept patterns. Lateral thinking is concerned with restructuring such patterns (insight) and provoking new ones (creativity). Lateral and vertical thinking are complementary. Skill in both is necessary. Although the emphasis in education has always been exclusively on vertical thinking, the need for lateral thinking arises from the limitations of the behaviour of mind as a self-maximizing memory system. Lateral thinking can be learned, practised and used. It is possible to acquire skill in it just as it is possible to acquire skill in mathematics. The course provides formal opportunities to practise lateral thinking and also an explanation of the processes involved.

Prerequisite

NIL

Course Outcomes

On the successful completion of the course students will be able to

CO Number	Course Outcome Statement	Weightage*** in %
CO1	Explain the concept of lateral thinking, distinguish it from vertical thinking.	10
CO2	Use lateral thinking for problem solving	10
CO3	Generate Alternatives, challenge assumptions and suspend judgment and Practice lateral thinking in design process	20
CO4	Apply the concept of factorization and reversal method for restructuring	20
CO5	Organize brainstorming sessions	10
CO6	Use PO for innovation	10
CO7	Aware of limitation of established patterns and practice lateral thinking in small projects	20

*** Weightage depends on Bloom's Level, number of contact hours,

CO Mapping with CDIO Curriculum Framework

CO's	TCE Proficiency Scale	Learning Domain Level			CDIO Curricular Components (X.Y.Z)
		Cognitive	Affective	Psychomotor	
CO1	TPS2	Understand	Respond	Guided Response	2.3.1, 3.2.6
CO2	TPS3	Apply	Value	Mechanism	2.4.1, 2.4.2, 2.4.3
CO3	TPS3	Apply	Value	Mechanism	2.4.1, 2.4.2, 2.4.3, 2.4.5, 2.4.6
CO4	TPS3	Apply	Value	Mechanism	2.3.1, 2.4.2, 2.4.3
CO5	TPS4	Analyse	Organize	Complex Overt Response	3.1.1, 3.1.2, 3.2.1, 3.2.2
CO6	TPS3	Apply	Value	Mechanism	2.1.4, 2.3.1, 2.4.1, 2.4.2, 2.4.3, 2.4.6
CO7	TPS5	Evaluate	Characterize	Adaptation	2.3.4, 4.5.1, 4.6.1

Mapping with Programme Outcomes and Programme Specific Outcomes

CO's	PO 1	PO 2	PO 3	PO 4	PO 5	PO 6	PO 7	PO 8	PO 9	PO 10	PO 11	PO1 2	PSO 1	PSO 2
CO 1	M	L	-	-	-	-	-	-	-	-	-	L	L	L
CO 2	S	M	L	-	-	-	-	-	-	-	-	L	M	L
CO 3	S	M	L	-	-	-	-	S	L	L	-	L	M	L
CO 4	S	M	L	-	-	-	-	S	L	L	-	L	M	L
CO 5	S	S	M	L	-	-	-	S	S	S	-	L	M	M
CO 6	S	M	L	-	-	-	-	-	-	-	-	L	L	L
CO 7	S	S	S	M	-	S	-	-	S	S	-	S	M	M

S- Strong; M-Medium; L-Low

Assessment Pattern: Cognitive Domain**Continuous Assessment**

Worksheets (5)	:	20 Marks
Case Studies (3)	:	30 Marks

Terminal Examination

Ability Test	:	50 Marks
Case Study (Best) Presentation and Viva Voce	:	20 Marks

Syllabus

The way the mind works, Difference between lateral and vertical thinking, Attitudes towards lateral thinking, Basic nature of lateral thinking, The use of lateral thinking Techniques, The generation of alternatives, Challenging assumptions, Innovation, Suspended judgment, Design, Dominant ideas and crucial factors, Fractionation, The reversal method, Brainstorming, Analogies, Choice of entry point and attention area, Random stimulation, Concepts/divisions/polarization, The new word PO, Blocked by openness, Description/problem solving/design

Learning Resources

- Edward de Bono, "Lateral Thinking: Creativity Step by Step", Happer Collins Publisher, 1990.
- Edward de Bono, "Six Thinking Hats", Little Brown and Company Publisher, 1985.
- Edward de Bono's Thinking Course, Video Lecture, Weblink: https://www.youtube.com/watch?v=AUq_AL2LNEw

Course Contents and Lecture Schedule

Module No.	Topic	No. of Hours	Course Outcome
1.	The way the mind works		CO1
1.1	Difference between lateral and vertical thinking		
1.2	Attitudes towards lateral thinking		

2.	Basic nature of lateral thinking		
2.1	The use of lateral thinking Techniques		
2.2	The generation of alternatives		
2.3	Challenging assumptions		
2.4	Innovation		
2.5	Suspended judgment		
3.	Design		
3.1	Dominant ideas and crucial factors		
3.2	Fractionation		
4.	The reversal method		
4.1	Brainstorming		
4.2	Analogies		
4.3	Choice of entry point and attention area		
4.4	Random stimulation		
4.5	Concepts/divisions/polarization		
	The new word PO		
5.	Blocked by openness		
5.1	Description/problem solving/design		

Course Designers:

2. S J. Thiruvengadam sjtece@tce.edu

18CEEA0	ENGINEERING GEOLOGY	Category	L	T	P	Credit
		ES	3	0	0	3

Preamble

Engineering Geology is the application of the geologic sciences to engineering practice for the purpose of assuring that the geologic factors affecting the engineering works are recognized and adequately provided for. Engineering geologic studies may be performed during the planning and design. A civil engineer should be able to understand an engineering geologic report, and incorporate adequate measures into the design of engineering works he is concerned with.

Prerequisite

- Basic Sciences

Course Outcomes

On the successful completion of the course students will be able to

CO Number	Course Outcome Statement	Weightage*** in %
CO1	Acquire the knowledge of the topographical formation, Interior earth, gradational activities and weathering. And also the theory of plate tectonics which answers the reason for the occurrence of earthquake, landslides in an area.	40
CO2	Interpret minerals and rocks and assessment of its physical, mechanical and engineering properties	25
CO3	Determine geological structures and its relevance on Civil engineering projects.	15
CO4	Analyze the surface and subsurface geological structures of the crust, soil and weathered thickness through geophysical exploration and report writing aspects with relevance to civil engineering projects.	
CO5	Assess the geological aspects of the site suitability with relevance to the design of structures civil and vice-versa.	20

*** Weightage depends on Bloom's Level, number of contact hours

CO Mapping with CDIO Curriculum Framework

CO's	TCE Proficiency Scale	Learning Domain Level			CDIO Curricular Components (X.Y.Z)
		Cognitive	Affective	Psychomotor	
CO1	TPS1	Understand	Respond	Guided Response	1.1.2 and 1.1.3
CO2	TPS2	Understand	Respond	Guided Response	1.1.2 and 1.1.3
CO3	TPS3	Apply	Value	Mechanism	1.1.2 and 1.1.3
CO4	TPS4	Apply	Value	Mechanism	1.1.1, 1.1.2 and 1.1.3
CO5	TPS5	Apply	Value	Mechanism	1.1.2 and 1.1.3

Mapping with Programme Outcomes and Programme Specific Outcomes

CO's	PO 1	PO 2	PO 3	PO 4	PO 5	PO 6	PO 7	PO 8	PO 9	PO 10	PO 11	PO 12	PSO 1	PSO 2
CO1	-	-	L	-	-	M	S	M	M	L	S	S	S	S
CO2	-	-	-	-	-	M	M	L	L	L	L	M	S	-
CO3	-	-	-	-	-	L	-	L	L	L	-	L	M	L
CO4	L	L	L	M	M	S	S	L	L	L	-	M	M	L
CO5	M	M	M	S	M	S	S	S	S	L	S	S	S	S

S- Strong; M-Medium; L-Low

Assessment Pattern: Cognitive Domain

Cognitive Levels	Continuous Assessment Tests			Assignment			Terminal Examination
	1	2	3	1	2	3	
Remember	40	20	20	-	-	-	20
Understand	60	40	40	-	-	-	40
Apply	-	40	40	10	10	10	40

Assessment Pattern: Psychomotor

Psychomotor Skill	Assignment %
Perception	--
Set	--
Guided Response	50
Mechanism	50
Complex Overt Responses	-
Adaptation	-
Origination	-

Course Outcome1(CO1):

1. Describe chemical weathering and its impact on civil works.
2. Name the gradational forces.
3. Outline landslides and its types.

Course Outcome2(CO2):

1. Summarise the relation between convectional current, plate movements and earthquake.
2. Name the ratings of earthquake.
3. Explain physical properties and behavior of seismic waves within the earth's interior.

Course Outcome3(CO3):

1. Outline engineering properties of important igneous rocks.
2. Explain engineering properties of important sedimentary rocks.
3. Classify physical properties of minerals.

Course Outcome3(CO4):

1. Illustrate how structures of rocks influence in the design of civil projects.
2. Apply the geophysical prospecting method for estimating thickness and depth of soil, weathered rock and depth to bed rock.
3. Classify faults with neat sketches.

Course Outcome3(CO5):

1. Describe site suitability for construction of dams.
2. Explain site suitability for road formation.
3. Determine site suitability for tall buildings

Concept Map

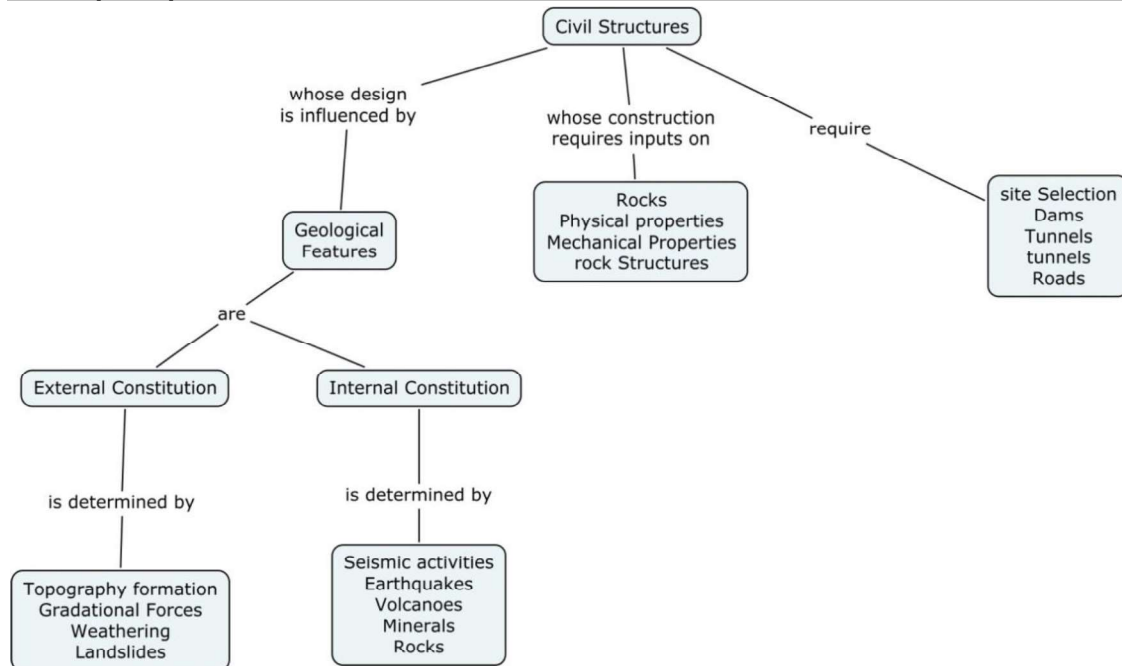

Syllabus

Introduction to Importance of Geology in Civil Engineering; Topographical formation- Structural components of the Continents and Oceans, and its importance with respect to Civil Engineering; Gradational forces – Types, Geological activities over continents and oceans, its impact in Civil Engineering works or design; Weathering- Types, Products, Factors and Civil Engineering consideration; Landslides – Classification, Causes, and Control; Internal Structure of the Earth - Seismological evidence and Interpretation; Plate Tectonics – Convictional current/forces, Continental Drift Theory, Types of plates, Types of movement, Plate boundary and Earthquakes; Earthquakes – Terminology, Classification, Causes and engineering consideration; Minerals- Physical properties; Rocks -Types and Origin of rocks, Physical, Mechanical and Engineering properties; Classification of Folds, Faults and Joints, Geological map readings, Geological Cross section and Bore hole log study and its relevance on Civil Engineering; Geological and Geophysical investigation for suitable site selection of Dams – Engineering properties and its suitability of different rocks, Tunnels – Geological profile and considerations, Roads – Topography, Complicated regions, weathering, lithological characters, Structures and Groundwater conditions, Bridges and Tall buildings – Topography, Weathering, Gradational activities, Structural disposition and Groundwater conditions.

Learning Resources

1. Parbin Singh: Engineering and General Geology, Taylor & Francis, 2009.
2. F.G. Bell (2007) Engineering Geology, Elsevier, 2nd ed.
3. F.G.H. Blyth & M.H. deFreitas (2001) A Geology for Engineers, Elsevier, 7th ed.
4. Structural Geology, 2010. Fossen H. Cambridge University Press, Cambridge.
5. Gonzalez de Vallejo, L.I. and Ferrer, M., 2011, Geological Engineering, CRC Press/Balkema, 678 pp.

6. Legget, R.F. and P.F. Karrow, 1983, Handbook of Geology in Civil Engineering, McGraw Hill, 1340 pp.

Course Contents and Lecture Schedule

Module No.	Topic	No. of Lectures	Course Outcomes
1.	GENERAL GEOLOGY		
1.1	Introduction and importance of geology in civil engineering	1	CO1
1.2	Topographical formation – continents	1	
1.3	Topographical formation – oceans	1	
1.4	Gradational forces- definition and its geological activities	1	
1.5	Weathering-definition and its types	1	
1.6	Weathering-products and factors controlling weathering	1	
1.7	Landslides-definition and classification	1	
1.8	Landslides-causes and prevention techniques	1	
2	Structural Divisions of Interior Earth		
2.1	Interior of the earth – Seismic waves definition, types and its characteristics	1	CO2
2.2	Interior of the earth – subdivisions based on physical properties and chemical properties by the behaviour of seismic waves	2	
2.3	Plate Tectonics theory – Origin and concept of theory, definition of plates, types, movement and its characteristics	1	
2.4	Convectional current -plate movement, earthquake, types and its classification, terminologies and causes of earthquake	2	
3	Minerals and Rocks		
3.1	Minerals –Definition, Important minerals physical properties	2	CO3
3.2	Rocks – origin, types	1	
3.3	Rocks – important igneous rocks physical, mechanical and engineering properties	1	
3.4	Rocks – important sedimentary rocks physical, mechanical and engineering properties	1	
3.5	Rocks – important metamorphic rocks physical, mechanical and engineering properties	1	
4	Structures of rocks		
4.1	Folds – types and its relevance to planning and in civil works	1	CO4
4.2	Faults – types and its relevance to planning and in civil works	1	
4.3	Joints - types and its relevance to planning and in civil works	1	
4.4	Geophysical study – estimation of thickness and depth of soil and weathered rock and depth to bed rock.	2	
4.5	Geological map, Cross section and Bore-hole log study	3	
5	Engineering Geology		
5.1	Geological investigation on site analysis for construction	2	CO5

Module No.	Topic	No. of Lectures	Course Outcomes
	of dams		
5.2	Geological investigation on site analysis for construction of tunnels	2	
5.3	Geological investigation on site analysis for construction of tall buildings and bridges	2	
5.4	Geological investigation on site analysis for construction of roads	2	
Total Hours		36	

Course Designers:

1. S.Palanivel spciv@tce.edu

18CEEB0	BUILDING PLANNING AND SERVICES	Category	L	T	P	Credit
		ES	3	0	0	3

Preamble

This course work imparts knowledge required for understanding the general principles of building planning and services with the help of relevant codes, manuals and guidelines

Prerequisite

No prerequisite

Course Outcomes

On the successful completion of the course students will be able to

CO Number	Course Outcome Statement	Weightage*** in %
CO1	Apply the general planning considerations for different types of buildings.	30
CO2	Relate and comprehend the integration of various types of buildings services involved in buildings	15
CO3	Understand the various types of buildings services involved in buildings	15
CO4	Adapt the principles of Electrical, water supply, sanitation, Lighting, Firefighting, H V A C Systems and allied Services.	20
CO5	Calculate the Planning and design requirements for Electrical, water supply, sanitation, Lighting, Firefighting , H V A C Systems and allied Services	20

*** Weightage depends on Bloom's Level, number of contact hours,

CO Mapping with CDIO Curriculum Framework

CO's	TCE Proficiency Scale	Learning Domain Level			CDIO Curricular Components (X.Y.Z)
		Cognitive	Affective	Psychomotor	
CO1	TPS3	Apply	Value	Mechanism	1.2,2.5.1,3.2.4.
CO2	TPS2	Understand	Respond	Guided response	1.2,2.5.1,3.2.4.
CO3	TPS2	Understand	Respond	Guided response	1.2,2.3.1,2.5.1,3.2.1,4.3.1,4.3.2, 4.4.5.
CO4	TPS3	Apply	Value	Mechanism	1.2,2.3.1,2.5.1,3.2.1,4.3.1,4.3.2, 4.4.5.
CO5	TPS3	Apply	Value	Mechanism	1.2,2.3.1,2.5.1,3.2.1,4.3.1,4.3.2, 4.4.5.

Mapping with Programme Outcomes and Programme Specific Outcomes

CO's	PO 1	PO 2	PO 3	PO 4	PO 5	PO 6	PO 7	PO 8	PO 9	PO 10	PO 11	PO 12	PSO 1	PSO 2
CO1	S	S	S	-	-	-	M	M	-	M	L	L	S	M
CO2	S	M	M	-	-	-	M	M	L	L	-	-	M	L
CO3	S	M	M	-	-	-	L	L	-	L	-	-	M	L
CO4	S	S	S	M	L	L	L	L	-	-	L	M	S	L
CO5	S	S	S	M	L	L	L	L	-	-	L	M	S	L

S- Strong; M-Medium; L-Low

Assessment Pattern: Cognitive Domain

Cognitive Levels	Continuous Assessment Tests			Assignment			Terminal Examination
	1	2	3	1	2	3	
Remember	20	20	20	-	-	-	20
Understand	35	35	35	-	-	-	35
Apply	45	45	45	10	10	10	45
Analyse							
Evaluate							
Create							

Assessment Pattern: Psychomotor

Psychomotor Skill	Miniproject /Assignment/Practical Component
Perception	-
Set	-
Guided Response	50
Mechanism	50
Complex Overt Responses	-
Adaptation	-
Origination	-

Sample Questions for Course Outcome Assessment****Course Outcome1(CO1):**

1. Discuss the planning considerations to be made in buildings based on codal provisions on fire safety
2. Assume an IT building is to be constructed in a metropolitan area of 20,000 sq.m. The width of road in front is 15 m. Plan the building according to F.S.I and height restrictions. Justify your recommendations.

Course Outcome2(CO2):

1. Discuss the various water conservation measures applied to an Educational Institute with hostel facility.
2. Discuss the Strategies and practices you will follow to build your own house as Green Building.

Course Outcome3(CO3):

1. Specify the minimum levels of illumination for different buildings as per NBC
2. Discuss the need of rain water harvesting system in a building.
3. Explain about the different systems of plumbing installed in buildings.

Course Outcome 4 (CO4):

1. Plan and draw an electrical layout for a residential building considering the essential electrical points in various rooms
2. Based on the water Resources available in your area of living, construct the flowchart for the treatment of water to fit for Drinking purpose.

Course Outcome 5 (CO5):

1. Suggest suitable fire-fighting installations needed for a commercial complex building of 4 floors
2. Select a suitable wiring system for a building having a connected load of 500kW. Make suitable assumptions. Justify your selection.

Concept Map

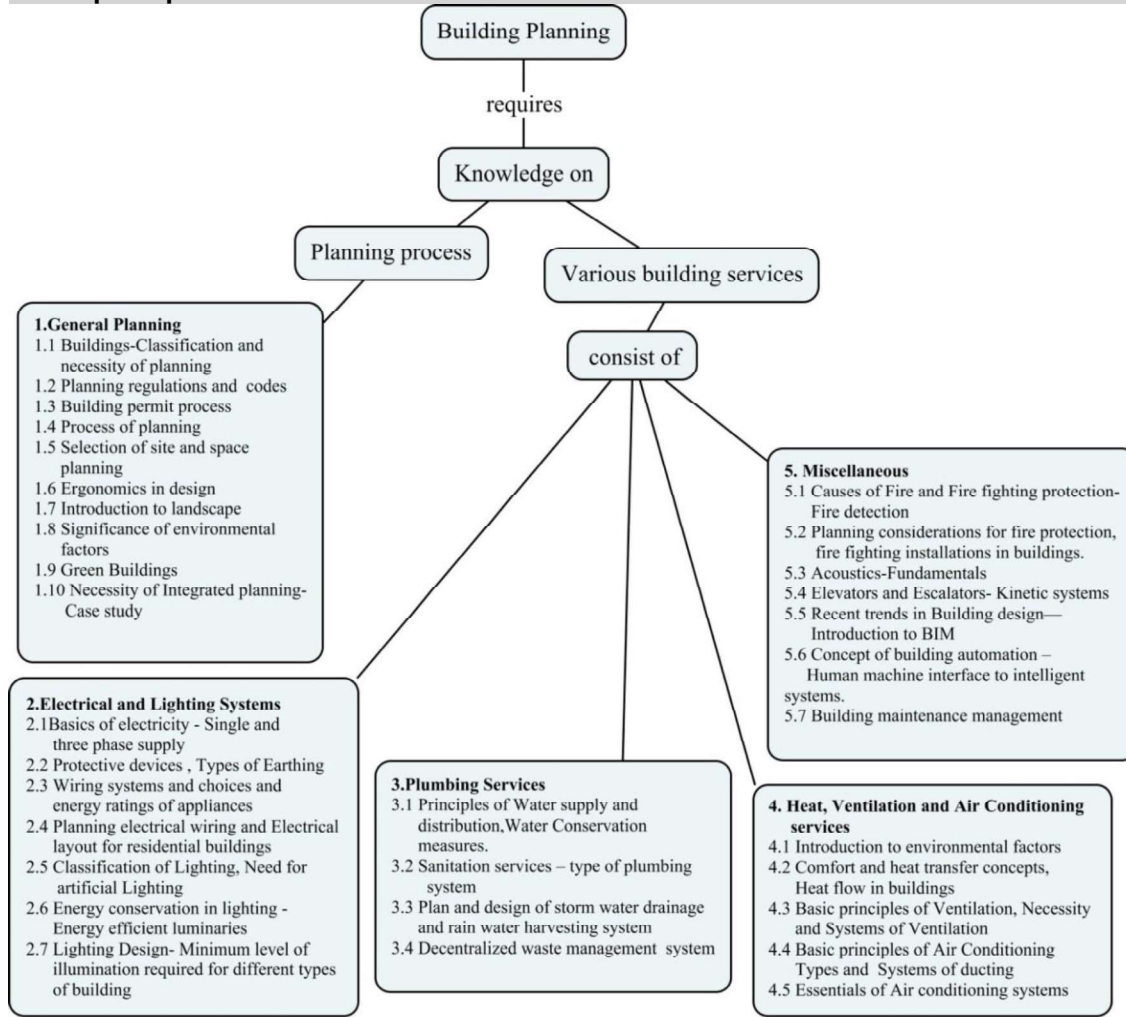

Syllabus

General Planning:—Buildings-Classification and necessity of planning-Planning regulations and relevant codes- Building permit process- Process of planning- Selection of site and space planning - Ergonomics in design- Introduction to landscape- Significance of environmental factors- Green Buildings - Necessity of Integrated planning-Case study.

Electrical and Lighting Systems:Basics of electricity - Single and three phase supply- Protective devices, Types of Earthing- Wiring systems and choices and energy ratings of appliances- Planning electrical wiring and Electrical layout for residential buildings - Classification of Lighting, Need for artificial Lighting - Energy conservation in lighting - Energy efficient luminaries - Lighting Design- Minimum level of illumination required for different types of building.

Plumbing Services: Principles of Water supply and distribution, Water Conservation measures-Sanitation services – type of plumbing system - Plan and design of storm water drainage and rain water harvesting system - Decentralized waste management system –wastewater and solid waste

Heating, Ventilation and Air Conditioning services: Introduction to environmental factors - Comfort and heat transfer

concepts, Heat flow in buildings-Basic principles of Ventilation, Necessity and Systems of Ventilation- Basic principles of Air Conditioning – Types and Systems of ducting, Essentials of Air conditioning systems. **Miscellaneous** - Causes of Fire and Fire fighting protection- Fire detection - Planning considerations for fire protection, fire fighting installations in buildings - Acoustics-Fundamentals - Elevators and Escalators- Kinetic systems, Recent trends in Building design—Introduction to BIM, Concept of building automation – Human machine interface & intelligent systems, Building maintenance management

Learning Resources

1. National Building Code of India -2016
2. Development Control Rules by Chennai Metropolitan Development Agency - 2006
3. Energy Conservation Building Code – 2007
4. CPHEEO Manual on Sewerage and sewage treatment systems – 2013
5. Manual for environmental clearance for large construction projects – by Ministry of environment, forest and climate change.

Course Contents and Lecture Schedule

Module No.	Topic	No. of Lectures	Course outcomes
1.0	General Planning		
1.1	Buildings-Classification and necessity of planning	1	CO1
1.2	Planning regulations and relevant codes	2	
1.3	Building permit process	1	
1.4	Process of planning	1	
1.5	Selection of site and space planning	1	
1.6	Ergonomics in design	1	
1.7	Introduction to landscape	1	
1.8	Significance of environmental factors	1	
1.9	Green Buildings	1	
1.10	Necessity of Integrated planning-Case study	2	
2.0	Electrical and Lighting Systems		
2.1	Basics of electricity - Single and three phase supply	1	CO3
2.2	Protective devices , Types of Earthing	1	CO2
2.3	Wiring systems and choices and energy ratings of appliances	1	CO5
2.4	Planning electrical wiring and Electrical layout for residential buildings	1	
2.5	Classification of Lighting, Need for artificial Lighting	1	CO4
2.6	Energy conservation in lighting - Energy efficient luminaries	1	
2.7	Lighting Design- Minimum level of illumination required for different types of building	1	CO5
3.0	Plumbing Services		
3.1	Principles of Water supply and distribution, Water Conservation measures.	1	,CO4

3.2	Sanitation services – type of plumbing system	1	CO2
3.3	Plan and design of storm water drainage and rain water harvesting system	1	CO5
3.4	Decentralized waste management system – wastewater and solid waste.	1	CO4
4.0	Heating, Ventilation and Air Conditioning services		
4.1	Introduction to environmental factors	1	CO3
4.2	Comfort and heat transfer concepts, Heat flow in buildings	2	
4.3	Basic principles of Ventilation, Necessity and Systems of Ventilation	1	CO2
4.4	Basic principles of Air Conditioning – Types and Systems of ducting	1	CO3
4.5	Essentials of Air conditioning systems	1	CO4
5.0	Miscellaneous		
5.1	Causes of Fire and Fire fighting protection- Fire detection	1	CO3
5.2	Planning considerations for fire protection, fire fighting installations in buildings.	1	CO5
5.3	Acoustics-Fundamentals	1	
5.4	Kinetic systems -Elevators and Escalators.	1	CO4
5.5	Recent trends in Building design & Introduction to BIM	1	CO2
5.6	Concept of building automation – Human machine interface and intelligent systems.	1	
5.7	Building maintenance management	1	CO3
	TOTAL	36	

Course Designers:

1. Dr.G.Chitra gcciv@tce.edu
2. V. Ravisankar environmentengr@tce.edu
3. D. Rajkumar rajkumarcivil@tce.edu

18CEEC0	SUSTAINABLE DEVELOPMENT	Category	L	T	P	Credit
		ES	3	0	0	3

Preamble

This coursework exposes the students to the complex relationships between social, economical and environmental processes

Course Outcomes

On the successful completion of the course students will be able to

CO Number	Course Outcome Statement	Weightage*** in %
CO1	Understand the basic idea on core competencies in Sustainable Development	15
CO2	Understand the International protocols and commitments towards Sustainability	15
CO3	Build an interdisciplinary perspective on Sustainable Development and learn the challenges, concerns and Responses	20
CO4	Learn and measure the sustainability through performance indicators	10
CO5	Familiarize with current debates on opportunities for Sustainable Development and analyse its relevance in various sectors	20
CO6	Explore and develop the strategies to achieve Sustainable Development in Indian context	20

*** Weightage depends on Bloom's Level, number of contact hours.

CO Mapping with CDIO Curriculum Framework

CO	TCE Proficiency Scale	Learning Domain Level			CDIO Curricular Components (X.Y.Z)
		Cognitive	Affective	Psychomotor	
CO1	TPS2	Understand	Respond	Guided Response	1.1,1.2,2.3.1,2.3.2,2.4.4,&3.2.1
CO2	TPS2	Understand	Respond	Guided Response	1.1,1.2,2.3.1,2.3.2,2.4.4,&3.2.1
CO3	TPS3	Apply	Value	Mechanism	1.1,1.2,2.3.1,2.3.2,2.4.4,3.2.1,4.1,4.4.1&4.4.5
CO4	TPS3	Apply	Value	Mechanism	1.1,1.2,2.3.1,2.3.2,2.4.4,3.2.1,4.1,4.4.1&4.4.5
CO5	TPS3	Apply	Value	Mechanism	1.1,1.2,2.3.1,2.3.2,2.4.4,3.2.1,4.1,4.4.1&4.4.5
CO6	TPS3	Apply	Value	Mechanism	1.1,1.2,2.3.1,2.3.2,2.4.4,3.2.1,4.1,4.4.1&4.4.5

Mapping with Programme Outcomes and Programme Specific Outcomes

Co s	PO 1	PO 2	PO 3	PO 4	PO 5	PO 6	PO 7	PO 8	PO 9	PO 10	PO 11	PO 12	PSO 1	PSO 2
CO 1	M	L	L	-	L	-	S	-	L	-	-	-	L	L
CO 2	M	L	L	-	L	-	S	-	L	-	-	-	L	M
CO	S	M	L	M	M	L	S	M	M	L	-	L	M	L

3														
CO 4	M	M	M	M	M	L	S	-	M	L	M	L	M	M
CO 5	M	M	-	-	-	M	S	M	M	L	-	L	M	M
CO 6	S	M	S	-	-	M	S	-	M	L	M	L	M	M

S- Strong; M-Medium; L-Low

AssessmentPattern: Cognitive Domain

Cognitive Levels	Continuous Assessment Tests			Assignment			Terminal Examination
	1	2	3	1	2	3	
Remember	12	12	12	-	-	-	12
Understand	48	48	48	-	-	-	48
Apply	40	40	40	10	10	10	40
Analyse	-	-	-	-	-	-	-
Evaluate	-	-	-	-	-	-	-
Create	-	-	-	-	-	-	-

AssessmentPattern: Psychomotor

Psychomotor Skill	Miniproject/Assignment/Practical Component
Perception	-
Set	-
Guided Response	50
Mechanism	50
Complex Overt Responses	-
Adaptation	-
Origination	-

Course Level Assessment Questions

Course Outcome 1(CO1)

1. Identify the linkages between Environment and Developmental activity.
2. How will you link social sustainability to environmental and economic sectors?
3. Trace the evolution of the concept of Sustainable Development.

Course Outcome 2(CO2)

1. Give an account of the international milestones in achieving goals of Sustainable Development.
2. Discuss about the outcome of any two international summit of Sustainable Development.

Course Outcome 3(CO3)

1. Discuss the possibilities to achieve sustainability in agricultural sector.
2. Identify the barriers to achieve sustainability in natural resources management especially in Developing nations.

Course Outcome 4(CO4)

1. How Sustainable Development can be assessed?
2. Discuss about the indicators of a country's development.
3. Illustrate the history of Commission on Sustainable Development indicators.

Course Outcome 5(CO5)

1. Enumerate the business-Industrial sector interaction in Sustainable Development
2. Discuss in detail about the sustainable movements happened towards water resources management sector

Course Outcome 6(CO6)

1. Suggest measures to tackle the inflated temperature (predicted) for May 2019. Construct a strategic plan to prevent 1°C rise by 2100 (this includes plans to reclaim all the effects of climate change to a state of equilibrium).
2. Considering the current world population, identify its emerging risks in 21st century (with respect to population, technology and resources) and suggest few sustainable solutions (general framework) in overcoming them.

Concept Map

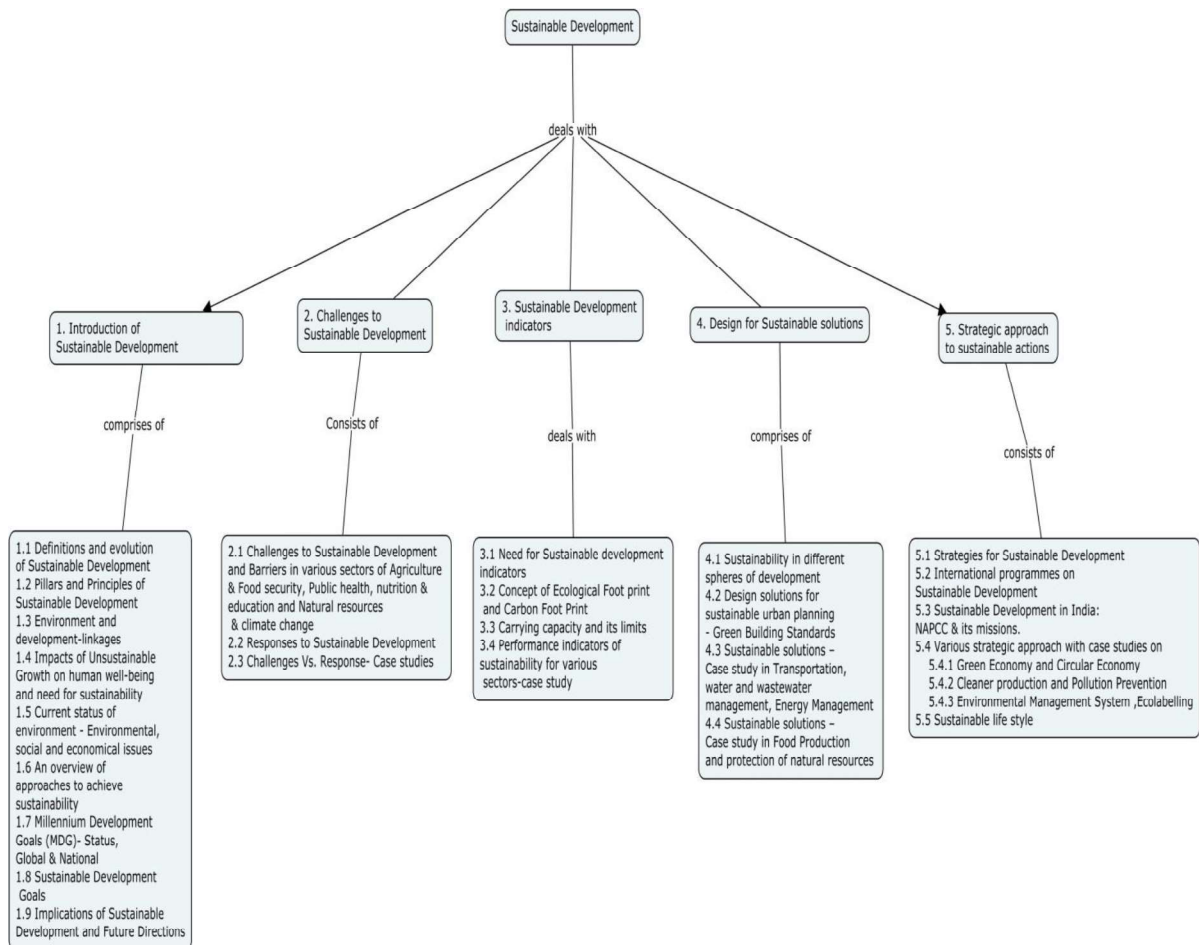

Syllabus

Introduction of Sustainable Development-Definitions ,evolution, Pillars and Principles of Sustainable Development-Environment and development linkages-Impacts of Unsustainable Growth on human wellbeing and need for sustainability-Current status of environment - Environmental, Social and Economic issues-An overview of approaches to achieve sustainability-Millennium Development Goals (MDG)- Sustainable Development Goals(SDG)-status of Implementation at National &Global level -Implications and Future Directions-**Challenges to Sustainable Development**-Challenges and Barriers in various sectors in the context of Climate Change, Responses to Sustainable Development- Challenges Vs. Response- Case studies. **Sustainable Development indicators**-Need for Sustainable Development indicators, Concept of Ecological Foot print and Carbon Foot Print, Carrying Capacity and its limits, Performance indicators of sustainability for various sectors. **Design for sustainable solutions**-Sustainability in different spheres of development, Design solutions for sustainable urban planning, Green Building Standards, Sustainable solutions–Case study in Transportation, Water and Wastewater management, Energy Management, Food Production, Resources and Life style. **Strategical approach to sustainable actions**-strategies for sustainable development, International programmes on Sustainable Development, Sustainable Development in India: NAPCC & its missions, Various strategic approach with case studies on-Green Economy and Circular Economy, Cleaner production and Pollution Prevention-Environmental Management System, Ecolabelling, and Sustainable life style.

Learning Resources

1. Kirkby, J., O'Keefe, P. and Timberlake, Sustainable Development, Earthscan Publication, London, 1993.
2. Low, N. Global ethics and environment. London: Routledge. 1999.
3. Sayer, J. and Campbell, B., The Science of Sustainable Development: Local Livelihoods and the Global Environment (Biological Conservation, Restoration &Sustainability), Cambridge University Press, London, 2003.
4. United Nations Indicators of Sustainable Development: Guidelines and Methodologies. New York: United Nations 2007.
5. UNEP, Towards a Green Economy: Pathways to Sustainable Development and Poverty Eradication, www.unep.org/greeneconomy, ISBN: 978-92-807-3143-9 ,2011.
6. World Bank "Inclusive Green Growth – The pathway to Sustainable Development, World Bank- Washington DC 2012.

Course Contents and Lecture Schedule

Module No.	Topic	No. of Hours	Course Outcome
1. INTRODUCTION OF SUSTAINABLE DEVELOPMENT			
1.1	Definitions and evolution of Sustainable Development	1	CO1
1.2	Pillars and Principles of Sustainable Development	1	CO1
1.3	Environment and development-linkages	1	CO1
1.4	Impacts of Unsustainable Growth on human well-being and need for sustainability	1	CO1

1.5	Current status of environment - Environmental, social and economical issues	1	CO1
1.6	An overview of approaches to achieve sustainability	1	CO1
1.7	Millennium Development Goals (MDG)- Status, Global & National	1	CO2
1.8	Sustainable Development Goals	1	CO2
1.9	Implications of Sustainable Development and Future Directions	1	CO2
2. CHALLENGES TO SUSTAINABLE DEVELOPMENT			
2.1	Challenges to Sustainable Development and Barriers in various sectors of Agriculture & Food security, Public health, nutrition & education and Natural resources & climate change	3	CO3
2.2	Responses to Sustainable Development	1	CO3
2.3	Challenges Vs. Response- Case studies	1	CO3
3.SUSTAINABLE DEVELOPMENT INDICATORS			
3.1	Need for Sustainable Development indicators	1	CO4
3.2	Concept of Ecological Foot print and Carbon Foot Print	2	CO4
3.3	Carrying capacity and its limits	1	CO4
3.4	Performance indicators of sustainability for various sectors-case study	2	CO4
4.DESIGN FOR SUSTAINABLE SOLUTIONS			
4.1	Sustainability in different spheres of development	1	CO5
4.2	Design solutions for sustainable urban planning - Green Building Standards	2	CO5
4.3	Sustainable solutions – Case study in Transportation, water and wastewater management, Energy Management	2	CO5
4.4	Sustainable solutions – Case study in Food Production and protection of natural resources	2	CO5
5.STRATEGIC APPROACH TO SUSTAINABLE ACTIONS			
5.1	Strategies for Sustainable Development	1	CO6
5.2	International programmes on Sustainable Development	2	CO2
5.3	Sustainable Development in India: NAPCC & its missions.	2	CO6
5.4	Various strategic approach with case studies on		
5.4.1	Green Economy and Circular Economy	1	C06
5.4.2	Cleaner Production and Pollution Prevention	1	CO6
5.4.3	Environmental Management System,Ecolabelling	1	CO6
5.5	Sustainable life style.	1	CO6
	Total	36 Hrs	

Course Designers:

1. Dr.S.Chandran schandran@tce.edu
2. Mr.V.Ravisankar environmentengr@tce.edu
3. Ms.K.Keerthy kkciv@tce.edu

18CEED0	ENERGY SCIENCE AND ENGINEERING	Category	L	T	P	Credit
		ES	3	0	0	3

Preamble

Energy resource scarcity becomes one of the biggest issues in the world and leading to rise in cost. Effective utilization of Electrical energy is one of the key issues to minimize the rising cost of energy and to minimize the global warming. The objective of the course is to provide an introduction to energy systems and renewable energy resources, with a scientific examination of the energy field and an emphasis on alternative energy sources and their technology and application. This course will educate the civil engineers on the aspect of energy conservation and management in buildings. The knowledge acquired lays a good foundation for design of various civil engineering systems/ projects dealing with these energy generation paradigms in an efficient manner.

Prerequisite

Nil

Course Outcomes

On the successful completion of the course students will be able to

CO Number	Course Outcome Statement	Weightage*** in %
CO1	Explain the main sources of energy and their primary applications nationally and internationally	10
CO2	Understand the effect of using energy sources on the environment and climate	15
CO3	Describe the challenges and problems associated with the use of various energy sources including fossil fuels	15
CO4	Capable to quantify energy demands and make comparisons among energy uses, resources and technologies.	20
CO5	Collect and organize information on renewable energy technologies as a basis for further analysis and evaluation	20
CO6	Identify the Energy Efficient practices and estimate energy saving potential in Buildings	20

CO Mapping with CDIO Curriculum Framework

CO'S	TCE Proficiency Scale	Learning Domain Level			CDIO Curricular Components (X.Y.Z)
		Cognitive	Affective	Psychomotor	
CO1	TPS 2	Understand	Respond	Guided Response	1.1.2, 1.1.3, 2.1.1, 4.1.2.
CO2	TPS 2	Understand	Respond	Guided Response	1.1.2, 1.1.3, 2.1.1, 2.5.1, 4.1.2.
CO3	TPS 2	Understand	Respond	Guided Response	1.1.2, 1.1.3, 4.1.2.
CO4	TPS 3	Apply	Value	Mechanism	1.1.1, 1.1.2, 1.1.3, 2.1.3, 4.1.5, 4.3.1.

CO5	TPS 3	Apply	Value	Mechanism	1.1.1, 1.1.2, 1.1.3, 2.1.3, 2.1.5, 2.5.4.
CO6	TPS 3	Apply	Value	Mechanism	1.1.1, 1.1.2, 1.1.3, 2.1.1, 2.1.3, 2.3.1, 2.4.1, 2.1.5, 2.5.2, 3.2.1, 4.1.1, 4.1.2, 4.1.5, 4.4.1,

Mapping with Programme Outcomes and Programme Specific Outcomes

Cos	PO 1	PO 2	PO 3	PO 4	PO 5	PO 6	PO 7	PO 8	PO 9	PO 10	PO 11	PO 12	PSO 1	PSO 2
CO1	S	-	-	-	-	-	-	-	S	S	-	-	L	M
CO2	S	-	-	-	-	-	-	-	-	S	-	-	L	L
CO3	S	S	S	S	-	M	-	-	-	-	-	-	S	-
CO4	S	S	S	S	-	M	-	-	-	-	-	-	S	-
CO5	S	S	S	S	-	-	-	-	-	-	-	-	S	-
CO6	S	-	-	-	-	L	-	-	-	-	-	-	L	-

S- Strong; M-Medium; L-Low

Assessment Pattern: Cognitive Domain

Cognitive Levels	Continuous Assessment Tests			Assignment			Terminal Examination
	1	2	3	1	2	3	
Remember	20	20	20	-	-	-	20
Understand	60	50	50	-	-	-	50
Apply	20	30	30	10	10	10	30
Analyse							
Evaluate							
Create							

Assessment Pattern: Psychomotor

Psychomotor Skill	Assignment
Perception	-
Set	-
Guided Response	50
Mechanism	50
Complex Overt Responses	-
Adaptation	-
Origination	-

Sample Questions for Course Outcome Assessment**

Course Outcome 1 (CO1):

1. Define the term per capita Energy consumption.
2. What is meant by Global Warming? What are the various reasons for Global Warming?
3. State the objective of Kyoto Protocol.
4. Discuss the Impacts of fossil fuel usage on Environmental. Also suggest methods to overcome

Course Outcome 2 (CO2):

1. Define contracted demand and billing demand.
2. A textile mill operates with a load of 1800kVA demand at 0.85 power factor lagging. If the power factor is improved from 0.85 to 0.95 lagging by adding additional capacitors, calculate the reduction in demand. The demand charge is Rs.300 per kVA demand per month. Calculate the demand cost saving per year due to the power factor improvement.
3. In a sub-station 2Nos. of identical 5000kVA 33kV / 11kV Transformers are operated parallel to meet a domestic load. The iron and full load copper loss of the above Transformer is 9.2 kW and 32.5kW respectively. Initially the two transformers are operated in parallel to meet the load. The load pattern of the domestic load is as follows:

Load in Kw	6000	3500	3000	8000	1500
Power factor	0.8 Lagging	0.78 Lagging	0.75 Lagging	0.9 Lagging	0.7 Lagging
Time in 24 Hours	6.00 A.M to 9.00 A.M	9.00 A.M to 12 Noon	12 Noon to 6.00 P.M	6.00 P.M to 10.00 P.M	10.00 P.M to 6.00 A.M

Suggest the best operating practice for the sub-station to minimize the transformer loss and also quantify the transformer loss minimized due to the best transformer operating practice.

Course Outcome 3 (CO3).

1. Name three types of motors in industrial practice.
2. An 89% efficient 30HP Size standard efficiency induction motor was replaced with a 93% efficient 30HP size Premium efficiency induction motor to improve energy efficiency. Calculate the Annual energy saving potential and payback period for the above proposal, using the following data given for the above applications.
 - Load factor - 90%
 - Operating Hours per year - 8000 Hours
 - Cost per kWh of Energy - Rs.5
 - Cost of Premium efficiency induction motor - Rs.60000/-
 - Scrap value of old standard efficiency induction motor - Rs.20000/-
 Assume the operating efficiency is as that of designed efficiency at 90% load factor condition.

Course Outcome 4 (CO4)

1. List the types of commonly used lamps.
2. Describe the methodology of lightning energy audit in an industrial facility.
3. In a factory shop floor lighting 60Nos. of 400Watts High Pressure Mercury Vapour(HPMV) lamps are replaced with 250Watts Metal Halide Lamps to reduce energy consumption. The luminous efficacy of HPMV Lamp and Metal Halide lamp are 60 & 100 Lumens per watt. Calculate the Annual energy saving potential and payback period for the above energy saving proposal, if the lamps are used for 12 Hours daily for 330Days in a year. The cost per fitting of Metal halide lamp is Rs.6000/- and cost per kWh energy is Rs.5/-.
4. In a Textile Mill to minimize the lighting power consumption Conventional 9Watts loss Tube light Ballast was replaced with 2Watts loss Electronic Ballast and 40Watts Tube lights are replaced with 36Watts tube lights in 750Nos. of Single Lamp Tube Light Fittings. The cost of Electronic Ballast and 36Watts Tube lights are Rs. 225 and

Rs.45/- per unit. Calculate the Power and Energy Saving Potential, if the mill operates for 8000 Hours in a year. Also calculate the investment required and payback period for the above ENCON Proposal, when the Energy cost is Rs. 4.50 per kWh.

Course Outcome 5 (CO5)

1. Specify the role of Turbo chargers.
2. List the energy savings opportunities in an industrial DG Set plant.
3. The Specific Fuel Consumption of a 500KVA Diesel Generating Set is 3.2kWh per litre of Diesel at 40% Load Factor. If the Load Factor is improved from 40% to 70%, the Specific Fuel Consumption is 3.8kWh per litre of Diesel. Calculate the fuel saving per day because of the load factor improvement.

Course Outcome 6 (CO6)

1. Specify the advantages of energy efficient motors.
2. Explain why centrifugal machines offer the greatest savings, when operating with Variable speed drives.
3. A 500KVA 11KV/415V Transformer was proposed to buy for an Industrial application. The conventional Core Transformer Cost Rs. 2,50,000/-, whereas the Energy Efficient Amorphous core Transformer cost Rs.2,90,000/-. The Iron losses of Conventional and Amorphous core Transformers are 2200 Watts and 800Watts respectively. The copper losses for the both the transformers are same. Calculate the payback period for the excess investment paid for the Energy efficient Amorphous core transformer, when compared to conventional core Transformer. The cost of Electrical Energy is Rs.5 per kWh and the Transformer proposed to operate for 8760 Hours in a year.
4. A Chemical industry planned to install a Maximum Demand Controller and an Automatic Power Factor Controller to minimize the Demand Cost. The existing Contracted Demand is 4500KVA and actual demand is 4375KVA. The electricity board billing is based on 90% of contracted demand or Actual demand reached, whichever is higher. The demand charge is Rs.400 per KVA per month. The existing power factor is 0.92 lagging. After installing the Maximum Demand Controller and Automatic Power factor controller, the Actual Maximum Demand reached is 3900KVA. The investment incurred in the Demand Saving measure is Rs. 9,00,000/-. Calculate the Demand Cost saving per year and Payback period for the above Encon proposal.

Concept Map

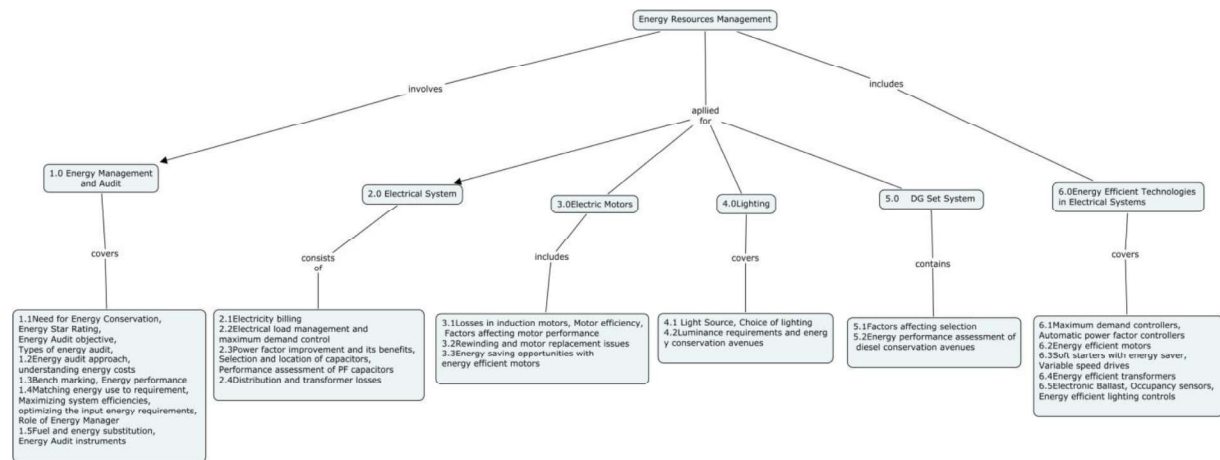

Syllabus

Introduction to Energy Science –Overview of Energy Systems, Sources, Transformations, efficiency and Storage. Environmental aspects of energy utilization -renewable energy resources and their importance. Energy Sources – Past, present & future of Fossil fuels, Remedies and alternatives for fossil fuels, Biomass, Wind, Solar, wave, tidal. Sustainability and environmental trade-offs of different energy systems. Energy storage. Energy & Environment – Energy Efficiency and conservation, Need of Energy Conservation, Energy Star Rating/Green Labeling, Introduction to clean energy technologies and its importance in sustainable development, Carbon footprint, Carbon credit, introduction to energy economics, linkages between economic and environmental outcomes. Civil Engineering Projects connected with the Energy Sources – Coal mining technologies, Oil exploration offshore platform, Underground and undersea oil pipelines, Solar chimney project, wave energy caissons, coastal installations for tidal power, wind mill tower, hydro power station above ground and underground along with associate dams, design and constraints and testing procedures for reactor containment building of spent nuclear fuel storage and disposal systems. Energy Management – Concept of Green Building and Green Building Architecture, LEED rating alternative ratings like Greha, Zero building energy, Identification of energy related enterprises that represent the breath of the industry and prioritizing these as candidates, Embodied energy analysis and use as a tool for measuring sustainability, Energy audit of facilities and optimization of energy consumption.

Learning Resources

1. B.H. Khan, "Non-Conventional Energy Resources" Tata McGraw-Hill Publishing Company Limited, 1st Edition, 2006.
2. Ghosh.B.Saha, S.K.Basu, Sujay, Towards Clean Energy, Tata McGraw Hill, New Delhi, 1996
3. Garg.H.P, Prakash.J, Solar Energy, Tata McGraw Hill, New Delhi, 2000
4. Book I - General aspect of energy management and energy audit, Second Edition 2005, By Bureau of Energy Efficiency, Ministry of Power, India.
5. Book III - Energy efficiency in electrical utilities, Second Edition 2005, By Bureau of Energy Efficiency, Ministry of Power, India.

Course Contents and Lecture Schedule

Module No.	Topic	No. of Lecture Hours	Course Outcome
1.0	Introduction to Energy Science		
1.1	Overview of Energy Systems, Sources, Transformations, efficiency and Storage.	3	CO1
1.2	Environmental aspects of energy utilization - renewable energy resources and their importance.	3	CO2
2.0	Energy Sources		
2.1	Past, present & future of Fossil fuels, Remedies and alternatives for fossil fuels	3	CO1
2.2	Biomass, Wind, Solar, wave, tidal.	3	CO5
2.3	Sustainability and environmental trade-offs of different energy systems. Energy storage	1	CO5
3.0	Energy & Environment		
3.1	Energy Efficiency and conservation, Need of Energy Conservation, Energy Star Rating/Green Labeling	2	CO3
3.2	Introduction to clean energy technologies and its importance in sustainable development, Carbon footprint, Carbon credit	3	CO3
3.3	Introduction to energy economics, linkages between economic and environmental outcomes.	1	CO4
4.0	Civil Engineering Projects connected with the Energy Sources		
4.1	Coal mining technologies, Oil exploration offshore platform, Underground and undersea oil pipelines,	3	CO4
4.2	Solar chimney project, wave energy caissons, coastal installations for tidal power, wind mill tower	3	CO5
4.3	Hydro power station above ground and underground along with associate dams	2	CO4
4.4	Design and constraints and testing procedures for reactor containment building of spent nuclear fuel storage and disposal systems.	2	CO4
5.0	Energy Management		
5.1	Concept of Green Building and Green Building Architecture, LEED and alternative ratings, Zero building energy	3	CO6
5.2	Identification of energy related enterprises that represent the breath of the industry and prioritizing these as candidates	2	CO6
5.3	Embodied energy analysis and use as a tool for measuring sustainability	2	CO6
	Total	36	

Course Designers:

1. Dr.V.Saravanan vseee@tce.edu
2. Mr.R.K.C.Jeykumar rkcyj@tce.edu

18CHAA0	ENVIRONMENTAL SCIENCES	Category	L	T	P	Credit
		AC	1	0	1	-

Preamble

The objective of this course is intended to make the students to understand the basic concepts of environment, ecology and pollution of the current environmental issues and to participate in various activities on conserving and protecting the environment.

Prerequisite

NIL

Course Outcomes

On the successful completion of the course students will be able to

CO Number	Course Outcome	Weightage*** in %
CO1	Describe the importance and progression of ecological system	15%
CO2	Explain the significance of natural resources	10%
CO3	Demonstrate the effects of pollution on environment and human beings	15%
CO4	Practice the suitable management method during disaster episode	10%
CO5	Explain the ethics and values related to Environment	15%
CO6	Describe the Traditional values and Impact of modernization on Environment	10%
CO7	Carry out group activities	25%

*** Weightage depends on Bloom's Level, number of contact hours,

CO Mapping with CDIO Curriculum Framework

CO #	TCE Proficiency Scale	Learning Domain Level			CDIO Curricular Components (X.Y.Z)
		Cognitive	Affective	Psychomotor	
CO1	TPS2	Understand	Respond	Guided Response	1.1,2.3.1,2.3.2,2.3.4
CO2	TPS2	Understand	Respond	Guided Response	1.1,2.3.1,2.3.2,2.3.4
CO3	TPS3	Apply	Value	Mechanism	1.1,2.1.1,2.1.5,2.4.1,4.1.2
CO4	TPS3	Apply	Value	Mechanism	1.1,2.4.1,2.4.7,4.1.1,4.1.2
CO5	TPS2	Understand	Respond	Guided Response	1.1,2.5.1,2.5.2,
CO6	TPS2	Understand	Respond	Guided Response	1.1,2.4.7,2.5.4,
CO7	TPS4	Analyse	Organise	Complex Overt Responses	3.1.1,3.1.2,3.1.3,3.1.4,4.1.1,4.1.2

Mapping with Programme Outcomes and Programme Specific Outcomes

Cos	PO 1	PO 2	PO 3	PO 4	PO 5	PO 6	PO 7	PO 8	PO 9	PO 10	PO 11	PO 12	PSO 1	PSO 2
CO1	M	-	-	-	-	L	S	-	-	-	-	-	L	L
CO2	M	-	-	-	-	L	-	L	-	-	-	-	L	L
CO3	M	M	-	-	L	M	S	-	-	-	-	-	M	L
CO4	M	-	L	L	L	M	M	-	-	-	-	-	M	L
CO5	L	-	-	-	-	-	-	M	-	-	-	-	L	L
CO6	L	L	-	-	-	-	M	-	-	-	-	-	L	L
CO7	S	M	M	M	M	M	-	-	S	M	M	-	S	M

S- Strong; M-Medium; L-Low

Assessment Pattern: Cognitive Domain

Cognitive Levels	Continuous Assessment Tests			Assignment [#]			Terminal Examination ^{***}
	1	2	3	1	2	3	
Remember	0	20	0	NA	NA	NA	Presentation on Case study report
Understand	0	40	0				
Apply	0	40	0				
Analyse	0	0	0				
Evaluate	0	0	0				
Create	0	0	0				

Assignment: Marks will be given for the review I, II & III of case study presentation.

*** Case study presentation and evaluation

- ❖ Each group comprise of maximum three students
- ❖ Students will submit the case study report similar to final year project report
- ❖ Evaluation of case study presentation is based on the approved rubrics

Method of Evaluation**a) Internal assessment**

S.No	Description	Max.marks	Final conversion
1	CAT -II	50	40
2	Assignment marks (from Review I,II & III)	3 X 10 =30	10
		Total	50

b) End semester examination – Case study presentation

Performance Index	Marks per Individual
Originality of the work	20
Data collected	20
Suggestion to overcome for the identified issues	20
Final Presentation	40
Total	100

1. Model Titles for Case Study:

2. 1. Environmental impacts of quarry industries in Melur Taluk.
3. 2. A study on impacts of tanneries on ground water and soil quality in Dindigul district.
4. 3. Effect of pharmaceutical industry on groundwater quality in poikaraipatty village, Alagar
5. Kovil.
6. 4. Solid waste and waste water management in TCE hostel.
7. 5. Environmental effect of Kudankulam atomic power plant.
8. 6. Case study on effect of Sterlite industry.
9. 7. Effect on ground water and soil quality by dyeing industries in Tiruppur.
10. 8. Effect of textile wastes in Karur District.
11. 9. Segregation of waste and its recycling by Madurai Municipality at Vellakkal
12. 10. Effect of fire work waste on atmosphere in Sivakasi region

Sample Questions for Course Outcome Assessment****Course Outcome 1(CO1):**

1. Describe the Universal Energy flow model in an Ecosystem.
2. Discuss the conversion of one ecosystem into another ecosystem with example.

3. Explain the multidisciplinary nature of the environment.

Course Outcome 2 (CO2):

1. Summarize the importance of Natural resources to animals and human beings.
2. Describe the role of an individual in the conservation of Natural resources.

Course Outcome 3(CO3):

1. Demonstrate the effects and control measures of air pollution
2. Investigate the sources and management methods of e-waste.

Course Outcome 4(CO4):

1. Dramatize the mitigation methods adopted in severe cyclone affected areas.
2. Suggest the precautionary steps to prevent life from flood.

Course Outcome 5 (CO5):

1. Discuss the need for public awareness on environmental protection.
2. Identify the requirement for the equitable utilization of natural resources.

Course Outcome 6(CO6):

1. Describe the traditional value systems of India.
2. Recall the environmental related points discussed in our Indian Vedas.
3. List out the impacts of modernization on environment

Concept map:

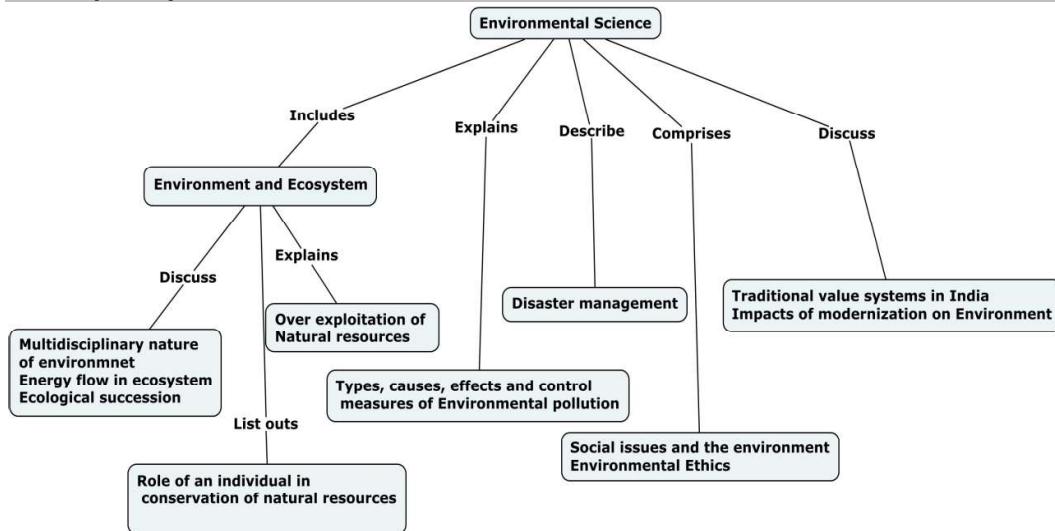

Syllabus

Environment and Ecosystem - Multidisciplinary nature of environment- Ecosystem- Energy flow in ecosystem-Ecological succession-Over exploitation of Natural resources-Role of an individual in conservation of natural resources. **Environmental pollution and control** - Environmental pollution – types, causes, effects and control measures - Disaster management strategies. **Environmental Ethics and Values** - Social issues and the environment -need for public awareness, Environmental Ethics- need for equitable utilization of natural resources- Traditional value systems in India, Impacts of modernization on Environment

Awareness and actual activities:

- ✓ Group meeting on water management, promotion of recycle use, reduction of waste,
- ✓ Plantation
- ✓ Cleanliness drive
- ✓ Drive on segregation of waste
- ✓ Energy saving
- ✓ Lectures by Environmentalist
- ✓ Slogan and poster making event

Learning Resources

1. Kaushik,A & Kaushik.C.P, Environmental Science and Engineering, 6th Edition, New Age International, 2018.
2. Erach Bharucha, Text book of Environmental studies for Undergraduate courses, 2nd Edition, UGC, 2013.
3. Gilbert M.Masters, Introduction to Environmental Engineering and Sciences, 2nd Edition, Pearson , 2004.
4. Garg S.K & Garg, Ecological and Environmental studies, Khanna Publishers, 2006.
5. Wright &Nebel, Environmental science towards a sustainable future, 8th Edition,Prentice Hall of India Ltd, 2002.
6. Documentary titled "HOME" by Yves Bertrand, Video Link: <https://www.youtube.com/watch?v=jqxENMKaeCU>

Course Contents and Lecture Schedule

Module No.	Topic	No. of Hours	Course Outcome
1.0	Environment and Ecosystem		
1.1	Multidisciplinary nature of environment-Ecosystem	1	CO1
1.2	Energy flow in ecosystem – Universal energy flow model	1	CO1
1.3	Ecological succession	1	CO1
1.4	Over exploitation of Natural resources	1	CO2
1.5	Role of individual in conservation of natural resources	1	CO2
2.0	Environmental pollution and control		
2.1	Environmental pollution – types(Air, Water,soil,Marine),	2	CO3
2.2	causes (gaseous, liquid, solid, plastic, e-waste, biomedical waste and radiations),	2	CO3
2.3	Effects and control measures of Pollution	2	CO3
2.4	Disaster managements during cyclone, Tsunami, flood, draught and earthquake	2	CO4
3.0	Environmental Ethics and Values		
3.1	Social issues and the environment -need for public awareness	1	CO5
3.2	Environmental Ethics- need for equitable utilization of natural resources	1	CO5
3.3	Traditional value systems in India,	1	CO6
3.4	Impacts of modernization on Environment	2	CO6
4.0	Awareness and actual activities		
4.1	Group meeting on water management, promotion of recycle use, reduction of waste	2	CO7
4.2	Plantation	1	CO7
4.3	Cleanliness drive	1	CO7
4.4	Drive on segregation of waste	1	CO7
4.5	Energy saving	1	CO7
4.6	Lectures by Environmentalist	1	CO7
4.7	Slogan and poster making event	Through online	CO7

Course Designers:

1. Dr.M.Kottaisamy hodchem@tce.edu
2. Dr.S.Rajkumar rajkumarsubramaniam@tce.edu

18CE310	DIFFERENTIAL EQUATIONS AND FOURIER SERIES	Category	L	T	P	Credit
		BS	3	0	0	3

Preamble

Differential equation is one of major part of mathematics through which we can express most of the real problem in mathematical expression. This course will explain the basic concept of special functions and how to solve the problem. It also develops student's skills in the formulation, solution, understanding and interpretation of PDE models. Near the end of the course, we combine previous ideas to solve an initial boundary value problem for a particular partial differential equation, the heat propagation equation etc.

Prerequisite

Differential Equations, Integration.

Course Outcomes

On the successful completion of the course students will be able to

CO Number	Course Outcome Statement	Weightage*** in %
CO1	Define operations with special functions.	10%
CO2	Solve a linear ordinary differential equation with variable coefficients.	15%
CO3	Produce a Fourier series of a given periodic function by evaluating Fourier coefficients	20%
CO4	Review basic properties of PDE's	10%
CO5	Solve Partial Differential Equations arising in engineering problems like Wave equation, Heat flow equation and other related equations by Fourier series.	15%
CO6	Compute the solution of the wave, diffusion and Laplace equations using the Fourier series	30%

CO Mapping with CDIO Curriculum Framework

CO #	TCE Proficiency Scale	Learning Domain Level			CDIO Curricular Components (X.Y.Z)
		Cognitive	Affective	Psychomotor	
CO1	TPS1	K1	A1	-	1.1.1, 2.1.1
CO2	TPS3	K3	A3	-	1.1.1,2.1.2, 2.1.5
CO3	TPS3	K3	A3	-	1.1.1, ,2.1.5
CO4	TPS2	K2	A2	-	1.1.1, ,2.1.5
CO5	TPS3	K3	A3	-	1.1.1, ,2.1.1, 2.1.5
CO6	TPS3	K3	A3	-	1.1.1, ,2.1.1,2.1.2,2.1.5

Mapping with Programme Outcomes and Programme Specific Outcomes

Cos	PO1	PO2	PO3	PO4	PO5	PO6	PO7	PO8	PO9	PO10	PO11	PO12	PSO1	PSO2
CO1	M	L		L										
CO2		S	S	S			M	S			S	S	S	S
CO3		S		S	S		M		M		S	S	M	S
CO4		L		M							M			
CO5		M		S			S	M		M	S	S	S	S
CO6		S	S	S	S		S	S	S	M	S			S

S- Strong; M-Medium; L-Low

Assessment Pattern: Cognitive Domain

Cognitive Levels	Continuous Assessment Tests			Assignment			Terminal Examination
	1	2	3	1	2	3	
Remember	10	10	10				10
Understand	30	20	20				20
Apply	60	70	70	100	100	100	70
Analyse							
Evaluate							
Create							

Sample Questions for course outcome Assessment**Course Outcome 1 (CO1):**

1. Define Legendre's Equation.
2. Write down the extension of the factorial $a_0 = \frac{1}{2^n n!}$ in Bessel function using gamma function.
3. State linear dependence of Bessel functions J_n and J_{-n} .

Course Outcome 2 (CO2):

1. Using indicated substitution, find a general solution in terms of J_ν and $J_{-\nu}$ for the ODE

$$x^2 y'' + xy' + (x^2 - \frac{1}{16})y = 0.$$

2. Derive P_0 to p_5 from the Legendre polynomial $p_n(x)$.
3. Using indicated substitution, find a general solution in terms of J_ν and Y_ν for the ODE

$$x^2 y'' + xy' + (x^2 - 25)y = 0.$$

Course Outcome 3 (CO3):

1. Obtain the Fourier series expansion of the periodic function $f(t)$ of period 2π defined by $f(t)=t$, $0 < t < 2\pi$.
2. Determine the half-range cosine series expansion of the function $f(t)=2t-1$, valid for $0 < t < 1$.
3. Determine the complex form of the Fourier series expansion of the periodic function $f(t)$

$$\text{defined by } f(t) = \cos \frac{t}{2}, -\pi < t < \pi$$

Course Outcome 4 (CO4):

1. Calculate the possible values of a and b in the expression $u = \cos at \sin bx$ such that it satisfies the wave equation.
2. Identify whether the function $u(x, y) = x^4 - 6x^2 y^2 + y^4$ satisfies the Laplace equation.
3. Define Helmholtz equation.

Course Outcome 5 (CO5):

1. Show that $u = u_0 \sin\left(\frac{\pi x}{L}\right) \cos\left(\frac{\pi c t}{L}\right)$ satisfies the one dimensional wave equation and the conditions

- a) a given initial displacement $u(x, 0) = u_0 \sin\left(\frac{\pi x}{L}\right)$, and

- b) zero initial velocity, $\frac{\partial u(x, 0)}{\partial t} = 0$

2. Show that the function $T = \frac{1}{\sqrt{t}} \exp\left(-\frac{x^2}{4kt}\right)$ satisfies the one dimensional heat-conduction equation.

3. Evaluate the general solution $u(x, t)$, of the partial difference equation $\frac{\partial u}{\partial t} + \frac{\partial u}{\partial x} = 0$.

Course Outcome 6 (CO6):

- Solve the wave equation for vibrations in an organ pipe subject to the boundary conditions
 - $u(0,t)=0$, $t \geq 0$, the end $x=0$ is closed.
 - $\frac{\partial u(l,t)}{\partial x} = 0$, $t \geq 0$, the end $x=l$ is open.
 - $u(x,0)=0$, $0 \leq x \leq l$, the pipe is initially undisturbed.
 - $\frac{\partial u(x,0)}{\partial t} = v = \text{const}$, the pipe is given an initial uniform blow.
- Solve the heat equation $\frac{\partial u}{\partial t} = k \frac{\partial^2 u}{\partial x^2}$ subject to the boundary conditions
 - $u(0,t)=0$, $t \geq 0$
 - $u(l,t)=0$, $t \geq 0$
 - $u(x,0)=u_0\left(\frac{1}{2} - \frac{x}{l}\right)$, $0 < x < l$.
- Solve the Laplace equation for steady heat equation in the semi-infinite region $0 \leq y \leq 1$, $x \geq 0$ and subject to the boundary conditions
 - $u(x,0)=0$, $x \geq 0$
 - $u(x,1)=0$, $x \geq 0$
 - $u(x,y) \rightarrow 0$ as $x \rightarrow \infty$

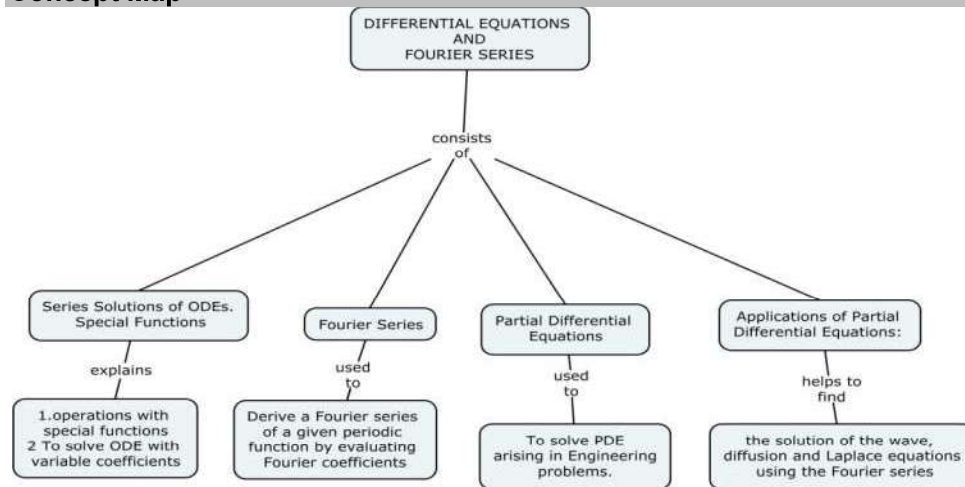
Concept Map**Syllabus**

Series Solutions of ODEs. Special Functions: Legendre's Equation. Legendre Polynomials; Bessel's Equation. Bessel Functions of the First kind and second kind; Bessel's function using Gamma function. **Fourier Series:** periodic functions; Fourier's theorem; The Fourier coefficients; Functions of period 2π ; Even and odd functions; Even and odd harmonics; Functions of period T ; Full range series; Half-range cosine and sine series; complex form of Fourier series: Complex representation; The multiplication theorem and Parseval's theorem. **Partial Differential Equations:** Basic Concepts; Wave equation; Heat conduction or diffusion; Laplace equation; other and related equations; Arbitrary functions. **Applications of Partial Differential Equations:** Formulation and Solution of the wave equation: D'Alembert's solution and characteristics; separated solutions; Laplace transform solution; Solutions of the diffusion equation; Separation method; Laplace transform method; Solution of the Laplace equation; Separated solutions.

Learning Resources

- Erwin Kreszig, "Advanced Engineering Mathematics", 9th edition, Wiley, 2017.

- Series Solutions of ODEs. Special Functions :5.3, 5.5, 5.6.
2. Glyn James “Advanced Engineering mathematics”, Pearson Education New Delhi, Third Edition, 2016.
 Fourier Series: 4.2.1, 4.2.2, 4.2.3, 4.2.4, 4.2.5, 4.2.6, 4.2.10, 4.3.1, 4.3.2, 4.6.1, 4.6.2.
 Partial Differential Equations: 9.2.1, 9.2.2, 9.2.3, 9.2.4, 9.2.5.
 Applications of Partial Differential Equations: 9.3.1, 9.3.2, 9.3.3, 9.4.1, 9.4.2, 9.5.1.
3. Peter V.O.Neil, “Advanced Engineering Mathematics”, 7th edition, Cengage Learning, 2017.

Course Contents and Lecture Schedule

Module No.	Topic	No. of Lectures	Course Outcome
1	Series Solutions of ODEs. Special Functions		
1.1	Legendre’s Equation. Legendre Polynomials	2	CO1,CO2
1.2	Bessel Functions of the First kind	2	CO1,CO2
	Bessel Functions of the second kind	1	CO1,CO2
1.3	Bessel’s function using Gamma function	1	CO2
2	Fourier Series:		
2.1	periodic functions	1	CO3
2.2	The Fourier coefficients	1	CO3
2.3	Fourier’s theorem	1	CO3
2.4	Functions of period 2π	1	CO3
2.5	Even and odd functions	1	CO3
2.6	Even and odd harmonics	1	CO3
2.7	Functions of period T	1	CO3
2.8	Full range series	1	CO3
2.9	Half-range cosine and sine series	1	CO3
2.10	complex form of Fourier series	1	CO3
2.11	Complex representation	1	CO3
2.12	The multiplication theorem and Parseval’s theorem.	1	CO3
3	Partial Differential Equations		
3.1	Basic Concepts	1	CO4
3.2	Wave equation	2	CO5
3.3	Heat conduction or diffusion	2	CO5
3.4	Laplace equation	1	CO5
3.5	other and related equations	1	CO5
3.6	Arbitrary functions	1	CO5
4	Applications of Partial Differential Equations		
4.1	Formulation and Solution of the wave equation	1	CO6
4.2	D’Alembert’s solution and characteristics	2	CO6
4.3	separated solutions	1	CO6
4.4	Laplace transform solution	1	CO6
4.5	Solutions of the diffusion equation	1	CO6
4.6	Separation method	1	CO6
4.7	Laplace transform method	1	CO6
4.8	Solution of the Laplace equation	1	CO6
4.9	Separated solutions	1	CO6
	TOTAL	36	

Course Designers

Prof. P.Subramanian	psmat@tce.edu
Dr.M. Sivanandha sarawathy	sivanandha@tce.edu
Dr.N. Chitra	ncmat@tce.edu

18CE320	MECHANICS OF SOLIDS	Category	L	T	P	Credit
		PC	2	1	0	3

Preamble

This course offers the basic modules of mechanics of solids such as articulated structures, suspension cables and suspension bridges. This course aims at determination of axial and bending stresses, design of circular shafts, slope and deflection of beams, effect of moving loads and construction of influence lines.

Prerequisite

Fundamentals of Engineering Mathematics and physics.

Course Outcomes

On the successful completion of the course students will be able to

CO Number	Course Outcome Statement	Weightage*** in %
CO1	Compute axial and bending stress.	20
CO2	Select sections for circular shafts.	16
CO3	Determine slope and deflection of determinate beams.	20
CO4	Calculate forces in a member of truss.	16
CO5	Demonstrate the effect of moving loads and to construct influence line diagram for determinate beams.	12
CO6	Analyse suspension cables, three hinged stiffening girders and three hinged arches.	16

*** Weightage depends on Bloom's Level, number of contact hours,

CO Mapping with CDIO Curriculum Framework

CO #	TCE Proficiency Scale	Learning Domain Level			CDIO Curricular Components (X.Y.Z)
		Cognitive	Affective	Psychomotor	
CO1	TPS2	Apply	Value	Mechanism	1.1.1,1.1.2,1.2,2.1.1,2.1.5.
CO2	TPS2	Apply	Value	Mechanism	1.1.1,1.2,2.1.1,2.1.5,2.3.1.
CO3	TPS3	Apply	Value	Mechanism	1.1.1,1.1.2,1.2,2.1.1,2.1.5.
CO4	TPS3	Apply	Value	Mechanism	1.1.1,1.2,2.1.1,2.1.5,3.2.5.
CO5	TPS3	Apply	Value	Mechanism	1.1.1,1.1.2,1.2,1.3,2.1.1,2.1.5,2.3.1,2.4.4.
CO6	TPS3	Apply	Value	Mechanism	1.1.1,1.1.2,1.2,1.3,2.1.1,2.1.5,2.3.1,2.4.3,3.2.6,4.1.2.

Mapping with Programme Outcomes and Programme Specific Outcomes

	PO1	PO2	PO3	PO4	PO5	PO6	PO7	PO8	PO9	PO10	PO11	PO12	PSO1	PSO2
CO1	S	S	M	-	-	L	-	-	-	M	-	-	L	L
CO2	M	M	-	-	-	-	-	-	-	-	L	-	L	L
CO3	S	S	-	-	-	-	-	-	-	-	-	-	L	L
CO4	S	S	-	M	-	M	-	-	-	-	-	-	M	M
CO5	S	S	-	-	-	L	M	-	M	S	-	-	M	M
CO6	S	S	M	-	-	L	M	-	-	-	-	-	M	L

S- Strong; M-Medium; L-Low

Assessment Pattern: Cognitive Domain

Cognitive Levels	Continuous Assessment Tests			Assignment			Terminal Examination
	1	2	3	1	2	3	
Remember	10	10	10	-	-	-	10
Understand	10	10	10	-	-	-	10
Apply	80	80	80	100	100	100	80
Analyse							
Evaluate							
Create							

Assessment Pattern: Psychomotor

Psychomotor Skill	Assignment
Perception	-
Set	50
Guided Response	50
Mechanism	-
Complex Overt Responses	-
Adaptation	-
Origination	-

Sample Questions for Course Outcome Assessment****Course Outcome 1 (CO1):**

- A rectangular column of size 250mm x 350mm is subjected to a load of 500kN at 120mm from the shorter edge and 45mm from the longer edge. Determine the stress distribution. What is the maximum load the column can sustain if the permissible stresses are +3.5 MPa and -35.0 MPa.
- A 6m long truss member comprises two ISA 100x100x10 section placed back to back. Determine its maximum load carrying capacity assuming $E = 190\text{GPa}$ and $\sigma_y = 360\text{MPa}$.
- A mild steel square tube of external dimensions 100mm and 5mm wall thickness is 3.6m long. Determine the maximum permissible eccentricity of load in the axial direction if the load is 80 percent of the Euler's load. Assume $E = 200\text{GPa}$ and $\sigma_y = 250\text{MPa}$ when
 - Both ends are hinged
 - One end is fixed and other end is free

Course Outcome 2 (CO2):

- Find the power transmitted by a shaft of 60mm diameter at 3Hz. If the maximum permissible shear stress is 70N/mm^2 .
- A solid shaft has to transmit 337.5kW at 100rpm. If the shear stress is not to exceed 65N/mm^2 and the internal diameter is 0.6 of the external diameter, find the external and internal diameters assuming that the maximum torque is 1.3times the mean.

Course Outcome 3 (CO3):

1. Develop the governing differential equation of beams.
2. A cantilever beam of span 6m is subjected to two point loads of 10kN and 15kN at 6m and 4m from the fixed end. Obtain the slope and deflection under the load points.
3. A simply supported beam of span 4.5m is subjected to a uniformly distributed load of 12kN/m over the left half of the span. Obtain the maximum deflection using Macaulay's method.

Course Outcome 4 (CO4):

1. Determine the force in the members of the truss shown in the following Figure.1

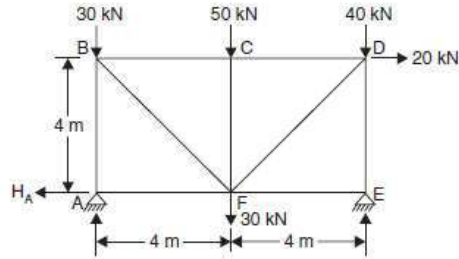

Figure.1

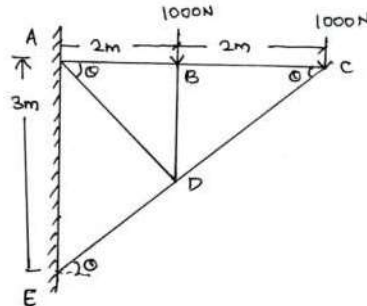

Figure.2

2. Determine the force in the members of the cantilever truss shown in Figure.2
3. Determine the force in the members BC, CE and EF of the truss of Figure.1 using method of sections.

Course Outcome 5 (CO5):

1. Mention the propositions related to two point loads.
2. A uniformly distributed load of intensity 30kN/m crosses a simply supported beam of span 60m from left to right. The length of udl is 15m. Find the value of maximum bending moment at a section 20m from left end. Find also the absolute maximum bending moment and shear force in the beam.
3. Construct the influence line diagram for shear force at section 3m and for bending moment at 4m for a simply supported beam of span 6m. Using the influence line diagram, obtain the shear force at 3m and bending moment at 4m if the beam is subjected to two point loads of 15kN and 20kN at 1.5m and 4.5m respectively.

Course Outcome 6 (CO6):

1. A suspension cable 100m span and 15m dip is stiffened with a three hinged girder. If a concentrated load of magnitude 100kN crosses the span, determine the maximum tension in the cable. Also, determine the greatest bending moment and shear force in the stiffening girder. State the position of the load in the above cases.
- A light cable 18m long is supported at two ends at the same level. The supports are 16m apart. The cable supports 120N load dividing the distance into two equal parts. Find the shape of the cable and the tension in the cable.
- A three hinged symmetric parabolic arch of span 60m and rise 12m is subjected to a concentrated load of 40kN acting at a distance 10m from its left support and a uniformly distributed load of intensity 10kN/m acting over its entire right half portion. Draw the bending moment diagram.

Concept Map

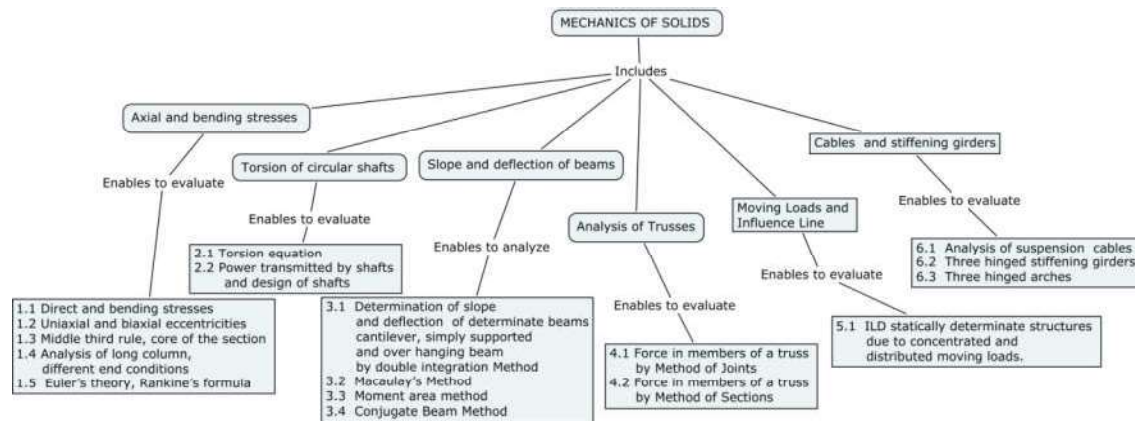

Syllabus

Axial and bending stresses: Direct and bending stresses – uniaxial and biaxial eccentricities – middle third rule – core of the section – analysis of long column – different end conditions – Euler’s theory – Rankine’s formula. **Torsion of circular shafts:** Introduction – derivation of torsion equation – assumptions – power transmitted by shafts – design of shafts. **Slope and deflection of beams:** Determination of slope and deflection of determinate beams – cantilever, simply supported and over hanging beam - Double Integration Method, Macaulay’s Method, Moment area Method and Conjugate Beam Method. **Analysis of Trusses:** Force in members of a truss – Method of Joints – Method of Sections. **Moving Loads and Influence Line:** Influence lines for reactions, shear force and bending moment in statically determinate structures due to concentrated and distributed moving loads. **Cables , stiffening girders and arches:** Analysis of cables, three hinged stiffening girders and three hinged arches.

Learning Resources

1. S S Rattan., Strength of Material, McGraw Hill Educational Private (india)Limited.2011
2. Bhavikatti S S, “Structural Analysis”, Vikas Publishing House Pvt. Ltd, New Delhi. 2009
3. Rajput., Strength of materials, S.Chand publishers, 4th edition, 2006
4. Thandavamoorthy, “Analysis of Structures”, Oxford &IBH Publishers, New Delhi.2008
5. Junnarkar, S.B. & Shah, H.J., Mechanics of structures, vol.I, II, Charotar Publishing House, India, 1999
6. NPTEL material <http://nptel.ac.in/courses/105106116/>

Course Contents and Lecture Schedule

Module No.	Topic	No. of Lectures	Course Outcome
1.0	Axial and Bending Stresses		
1.1	Direct and bending stresses	1	CO1
1.2	Uniaxial and biaxial eccentricities	1	
1.3	Middle third rule, core of the section	1	
1.4	Analysis of long column,different end conditions	1	
	Tutorial	1	
1.5	Euler’s theory, Rankine’s formula	1	
	Tutorial	1	
2.0	Torsion of circular shafts		
2.1	Introduction, derivation of torsion equation	2	

2.2	Power transmitted by shafts and design of shafts	2	CO2
	Tutorial	2	
3.0	Slope and deflection of beams		
3.1	Determination of slope and deflection of determinate beams – cantilever, simply supported and over hanging beam by double integration Method	1	CO3
	Tutorial	1	
3.2	Macaulay's Method	2	
	Tutorial	1	
3.3	Moment area method	2	
4.0	Analysis of Trusses		
4.1	Force in members of a truss by Method of Joints	2	CO4
	Tutorial	1	
4.2	Force in members of a truss by Method of Sections	2	
	Tutorial	1	
5.0	Moving Loads and Influence Line		
5.1	Influence lines for reactions, shear force and bending moment in statically determinate structures due to concentrated and distributed moving loads.	2	CO5
	Tutorial	2	
6.0	Cables, Suspension Bridges and Arches		
6.1	Analysis of suspension cables	2	CO6
6.2	Three hinged stiffening girders	1	
	Tutorial	1	
6.3	Three hinged arches	1	
	Tutorial	1	
Total Hours (24 Hrs+12 Hrs)		36 Hrs	

Course Designers:

1. Dr. S. Nagan nagan_civil@tce.edu
2. Mr.R.Sankaranarayanan rsciv@tce.edu

18CE330	Fluid Mechanics	Category	L	T	P	Credit
		PC	2	1	0	3

Preamble

Fluid Mechanics is a subject of engineering science deals with the behavior of fluids at rest as well as in motion. It is an important subject with unlimited practical applications ranging from biological systems to automobiles, airplanes and spacecraft propulsion. Thus this subject is given considerable importance in Civil, Mechanical and Chemical Engineering at core as well as at professional levels.

Prerequisite

18MA110, 18PHA20, 18MA210

Course Outcomes

On the successful completion of the course students will be able to

CO Number	Course Outcome Statement	Weightage*** in %
CO1	Apply the knowledge of fluid properties in real fluid flow problems	11
CO2	Determine the pressure of fluids in pipes as well as hydrostatic forces in submerged planes.	14
CO3	Calculate the velocity and acceleration of fluids in pipes.	14
CO4	Apply Bernoulli's theorem to solve a variety of fluid flow problems.	20
CO5	Calculate the major and minor losses in flow through pipes.	33
CO6	Determine the boundary layer thickness and other boundary layer properties	8

*** Weightage depends on Bloom's Level, number of contact hours,

CO Mapping with CDIO Curriculum Framework

CO #	TCE Proficiency Scale	Learning Domain Level			CDIO Curricular Components (X.Y.Z)
		Cognitive	Affective	Psychomotor	
CO1	TPS3	Apply	Value	Mechanism	1.1.1, 1.1.2, 1.2, 2.1.5
CO2	TPS3	Apply	Value	Mechanism	1.1.1, 1.1.2, 1.2, 2.1.5
CO3	TPS3	Apply	Value	Mechanism	1.1.1, 1.1.2, 1.2, 2.1.5
CO4	TPS3	Apply	Value	Mechanism	1.1.1, 1.1.2, 1.2, 2.1.5, 2.5.1
CO5	TPS3	Apply	Value	Mechanism	1.1.1, 1.1.2, 1.2, 2.1.5, 2.5.1
CO6	TPS3	Apply	Value	Mechanism	1.1.1, 1.1.2, 1.2, 2.1.5,

Mapping with Programme Outcomes and Programme Specific Outcomes

Cos	PO1	PO2	PO3	PO4	PO5	PO6	PO7	PO8	PO9	PO10	PO11	PO12	PSO1	PSO2
CO1	S	S	-	-	-	-	-	-	-	-	-	-	M	-
CO2	S	S	M	L	-	-	-	-	-	-	-	-	M	-
CO3	S	S	-	-	-	-	-	-	-	-	-	-	M	-
CO4	S	S	L	L	-	L	-	M	-	-	-	-	M	L
CO5	S	S	M	L	-	L	-	M	-	-	-	-	M	L
CO6	S	S	M	-	-	-	-	-	-	-	-	-	M	-

S- Strong; M-Medium; L-Low

Assessment Pattern: Cognitive Domain

Cognitive Levels	Continuous Assessment Tests			Assignment			Terminal Examination
	1	2	3	1	2	3	
Remember	20	20	20	-	-	-	20
Understand	20	20	20	-	-	-	20
Apply	60	60	60	100	100	100	60
Analyse	---	---	---	---	---	---	---
Evaluate	---	---	---	---	---	---	---
Create	---	---	---	---	---	---	---

Assessment Pattern: Psychomotor

Psychomotor Skill	Mini-project /Assignment/Practical Component
Perception	--
Set	--
Guided Response	50
Mechanism	50
Complex Overt Responses	---
Adaptation	---
Origination	---

Sample Questions for Course Outcome Assessment**

** (2 to 3 at the cognitive level of course outcome)

Course Outcome 1(CO1):

1. A cylindrical shaft of 90mm diameter rotates about a vertical axis inside a fixed cylindrical tube of length 50cm and 95mm diameter. If the space between the tube and shaft is filled by a lubricant of viscosity 2 poise, determine the power required to overcome viscous resistance when the shaft is rotated at a speed of 240 rpm
2. The space between the two square flat parallel plates is filled with oil. Each side of the plate is 75cm. The thickness of the oil film is 15mm. The upper plate which moves at 3m/s requires a force of 120N to maintain the speed, Determine (i) The dynamic viscosity of oil and (ii) The kinematic viscosity of oil, if the specific gravity of oil is 0.95.
3. A mass of liquid weighs 500 N when exposed to standard earth's gravity $g = 9.81\text{m/s}^2$. (i) What is its mass? and (ii) What will be its weight in a planet with acceleration due to gravity of 3.5m/s^2 .

Course Outcome 2 (CO2):

1. U tube differential mercury manometer is connected on one side to pipe A containing oil of specific gravity 1.5 while on the other side to pipe B containing oil of specific gravity 0.9. The pipe A lies 3m below pipe B. The mercury level in the limb communicating with pipe A lies 2m below the center of pipe A and 3m below center of pipe B in the limb communicating with pipe B. Determine the difference in pressure between the two pipes.
2. A 6m deep tank contains 4 m of water and 2 m of oil of relative density 0.88. Determine the pressure at the bottom of the tank and at the interface of two liquids.
3. Determine the total pressure on a circular plate of diameter 1.5m which is placed vertically in water in such a way that the centre of plate is 3m below the free surface of water. Find the position of centre of pressure also.

Course Outcome 3 (CO3):

1. In a two dimensional incompressible flow field the velocity components are expressed as $u = 2x - x^2y + y^3/3$, $v = xy^2 - 2y - x^3/3$,
(i) Is the flow possible? If so obtain an expression for the stream function.
(ii) Determine the velocity potential function also.
2. In a two dimensional incompressible flow, the fluid velocity components are given by $u = x-4y$ and $v = -y-4x$. Show that the velocity potential exists and determine its form. Find also the stream function.
3. The diameters of a pipe at the sections X and Y are 10 cm and 20 cm respectively. Find the discharge through the pipe if the velocity of water flowing through the pipe at X is 3.0 m/s. Also find the velocity at section Y.

Course Outcome 4 (CO4):

1. A pipe carrying water has a 30 cm x 15 cm venturimeter which is positioned inclined at 30° to the horizontal. The flow is upwards. The converging cone is 45 cm in length and $C_d = 0.98$. A differential U tube mercury manometer connected to inlet and throat shows a reading of 30 cm. (i) Calculate the discharge in the pipe and (ii) If the pressure at the inlet is 50 N/cm^2 , determine the pressure at the throat.
2. In a smooth pipe of uniform diameter 25cm a pressure of 50 N/cm^2 was observed at section 1 which was at elevation of 10m. At another section 2 at elevation of 12m the pressure was 20 N/cm^2 and the velocity was 1.25m/s. Determine the direction of flow and the head loss between the two sections. Water is flowing through the pipe.
3. Derive the Bernoulli's equation from fundamental stating all assumptions made.

Course Outcome 5 (CO5):

1. An oil of viscosity 8 poise and specific gravity 0.9 is flowing through a horizontal pipe of 50 mm diameter. If the pressure drop in 100m length of the pipe is 2000 kN/m^2 , determine (i) Rate of flow of oil, (ii) Centre line velocity, (iii) Total frictional drag over 100m length of pipe and (iv) Velocity and shear stress at 10 mm from the wall. Assume laminar flow through the pipe
2. The difference in water surface levels in two tanks which are connected by three pipes in series of length 350 m, 200 m and 250 m and diameters 20 cm, 30 cm and 15 cm respectively is 20 m. Determine the rate of flow of water, if coefficient of friction for these pipes is same and equal to 0.005 by considering all losses.
3. A reservoir discharges its liquids through a horizontal pipeline into the atmosphere. The pipeline consists of two pipes, one of 10 cm diameter and 25 m long and another 12 cm diameter and 35 m long connected in series. The friction coefficient $f = 0.005$ for both the pipes. The water level in the tank is 10 m above centre line of the pipe at the entrance. Calculate the discharge when the 10 cm diameter pipe is joined to the tank.

Course Outcome 6 (CO6):

1. Describe the development of boundary layer and its importance with neat sketch.
2. Find the displacement thickness, momentum thickness, energy thickness and shape factor for the velocity distribution in the boundary layer is given by $u / U = (y / \delta)^{1/7}$ where $\delta =$ boundary layer thickness.
3. The velocity distribution in the boundary layer is given by $u / U = y / \delta$, where u is the velocity at a distance of y from the plate and $u = U$ at $y = \delta$, δ being boundary layer thickness. Find the displacement thickness, momentum thickness, energy thickness and shape factor.

Concept Map

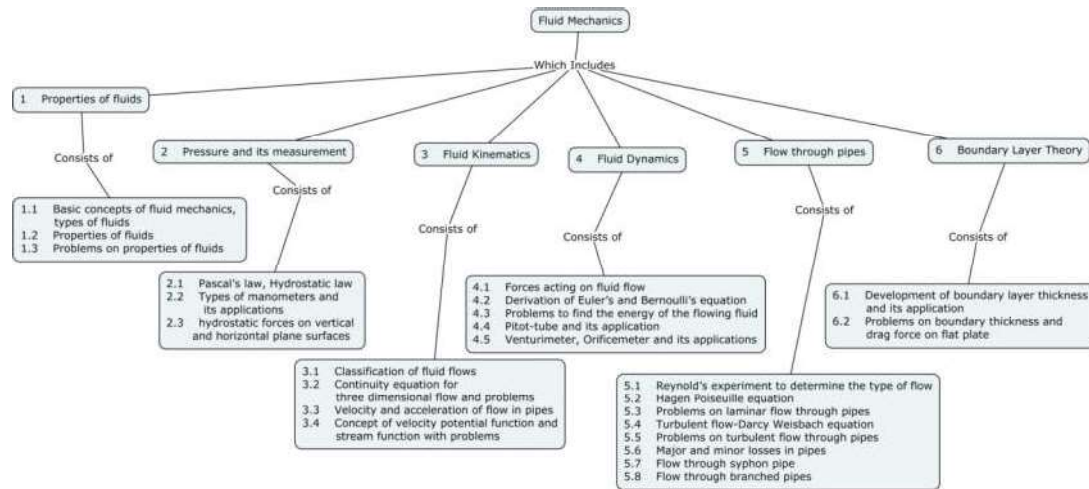

Syllabus

Fluid Properties: Density, Specific weight, Specific volume, Specific gravity, Viscosity, Kinematic viscosity, Surface tension, Compressibility, Capillarity, types of fluids. **Pressure Measurements:** Pascal’s law, Hydrostatic law, Manometers, hydrostatic forces on vertical and horizontal plane surfaces, **Fluid Kinematics:** Types of fluid flows, continuity equation, velocity and acceleration, potential function and stream function. **Fluid Dynamics:** Euler’s equation, Bernoulli’s equation and its applications in flow measuring devices like Pitot tube, Venturimeter and Orificemeter. **Flow through pipes:** Reynold’s experiment, Laminar and turbulent flow through circular pipes, major and minor losses in pipes, flow through syphon, flow through branched pipes. **Boundary Layer Theory:** Boundary layer theory and its application, drag force on a flat plate

Learning Resources

1. Modi P.N and Seth S.M, “Hydraulics and Fluid Mechanics Including Hydraulic Machines” Standard Book House” New Delhi, 20th Edition 2004
2. Yunus A. Cengel and John M. Cimbala, “Fluid Mechanics” Fundamentals and Applications, Tata McGraw Hill Publishing Company Ltd, New Delhi, 2015
3. Bansal R.K, “A Text Book of Fluid Mechanics and Hydraulic Machines” Lakshmi Publications, New Delhi, 2017
4. Kumar.K.L, “Engineering Fluid Mechanics” S.Chand Ltd., New Delhi, 2016.
5. <https://nptel.ac.in/courses/105101082/30>

Course Contents and Lecture Schedule

Module No.	Topic	No. of Hours	Course Outcome
1	Properties of fluids		CO1
1.1	Basic concepts of fluid mechanics, types of fluids	1	
1.2	Properties of fluids	1	
1.3	Problems on properties of fluids-Tutorial	2	
2	Pressure and its measurement		CO2
2.1	Pascal’s law, Hydrostatic law	1	

2.2	Types of manometers and its applications	1	
2.3	hydrostatic forces on vertical and horizontal plane surfaces	1	
	Tutorial	2	
3	Fluid Kinematics		
3.1	Classification of fluid flows	1	CO3
3.2	Continuity equation for three dimensional flow and problems	1	
3.3	Velocity and acceleration of flow in pipes	1	
3.4	Concept of velocity potential function and stream function with problems-Tutorial	2	
4	Fluid Dynamics		
4.1	Forces acting on fluid flow	1	CO4
4.2	Derivation of Euler's and Bernoulli's equation	1	
4.3	Problems to find the energy of the flowing fluid	1	
4.4	Pitot-tube and its application	1	
4.5	Venturimeter, Orificemeter and its applications	1	
4.6	Tutorial	2	
5	Flow through pipes		
5.1	Reynold's experiment to determine the type of flow	1	CO5
5.2	Hagen Poiseuille equation	1	
5.3	Problems on laminar flow through pipes	2	
5.4	Turbulent flow-Darcy Weisbach equation	1	
5.5	Problems on turbulent flow through pipes	2	
5.6	Major and minor losses in pipes	1	
5.7	Flow through syphon pipe	1	
5.8	Flow through branched pipes	1	
5.9	Tutorial	2	
6	Boundary Layer Theory		
6.1	Development of boundary layer thickness and its application	1	CO6
6.2	Problems on boundary thickness and drag force on flat plate-Tutorial	2	
Total Hours (24 Hrs+12 Hrs)		36	

Course Designers:

1. Mr. M.Ramasamy mrciv@tce.edu
2. Dr. T. Baskaran tbciv@tce.edu

18CE340	WATER SUPPLY ENGINEERING	Category	L	T	P	Credit
		PC	2	1	0	3

Preamble

This course work aims at imparting the knowledge on various stages of works involved in planning, designing and execution of protected water supply system to a town/city. Starting from demand estimation, identification of sources, studying the quality aspects of water at these sources, evolving a suitable treatment method to bring the quality to the permissible standards and finally, distribution of this treated water to the individual dwelling units are well addressed.

Course Outcomes

On the successful completion of the course students will be able to

CO Number	Course Outcome Statement	Weightage*** in %
CO1	Estimate the total water demand for a town/city	15
CO2	Identify suitable sources of water to meet the demand	10
CO3	Design the conduits for transportation of water from the source to treatment plant and to the city	15
CO4	Prepare the physical, Chemical and biological characteristics of different sources of water	15
CO5	Design an appropriate treatment system for the water available at the source	25
CO6	Design a good water distribution system for a town/city.	20

*** Weightage depends on Bloom's Level, number of contact hours,

CO Mapping with CDIO Curriculum Framework

CO's	TCE Proficiency Scale	Learning Domain Level			CDIO Curricular Components (X.Y.Z)
		Cognitive	Affective	Psychomotor	
CO1	TPS2	Understand	Respond	Guided Response	1.1.1, 1.2.1.1, 3.1.1, 3.1.5, 3.2.5
CO2	TPS2	Understand	Respond	Guided Response	1.1.1, 1.2.1.1, 3.1.1, 3.1.5, 3.2.5
CO3	TPS3	Apply	Value	Mechanism	1.1.1, 1.1.2, 1.2.1.1, 3.1.1, 3.1.5, 3.2.5
CO4	TPS2	Understand	Respond	Guided Response	1.1.1, 1.2.1.1, 3.1.1, 3.1.5, 3.2.5
CO5	TPS3	Apply	Value	Mechanism	1.1.1, 1.1.2, 1.2.1.1, 3.1.1, 3.1.5, 3.2.5
CO6	TPS3	Apply	Value	Mechanism	1.1.1, 1.1.2, 1.2.1.1, 3.1.1, 3.1.5, 3.2.5

Mapping with Programme Outcomes and Programme Specific Outcomes

Cos	PO1	PO2	PO3	PO4	PO5	PO6	PO7	PO8	PO9	PO10	PO11	PO12	PSO1	PSO2
CO1	S	L	L	L	-	-	S	-	-	-	-	-	M	L
CO2	S	S	M	M	-	-	S	-	-	-	-	-	M	L
CO3	S	S	S	S	-	-	M	-	-	-	-	-	M	M
CO4	S	S	L	S	-	S	S	M	M	-	L	-	L	L
CO5	S	S	S	S	-	-	S	M	-	-	L	-	M	M
CO6	S	S	S	S	-	-	S	-	-	-	L	-	L	L

S- Strong; M-Medium; L-Low

Assessment Pattern: Cognitive Domain

Cognitive Levels	Continuous Assessment Tests			Assignment			Terminal Examination
	1	2	3	1	2	3	
Remember	20	20	20	-	-	-	20
Understand	40	40	40	-	-	-	40
Apply	40	40	40	100	100	100	40
Analyse	-	-	-	-	-	-	-
Evaluate	-	-	-	-	-	-	-
Create	-	-	-	-	-	-	-

Assessment Pattern: Psychomotor

Psychomotor Skill	Mini project / Assignment / Practical Component
Perception	-
Set	-
Guided Response	50
Mechanism	50
Complex Overt Responses	-
Adaptation	-
Origination	-

Sample Questions for Course Outcome Assessment****Course Outcome1 (CO1):**

1. Identify design period for different components of water supply system
2. Describe fluctuation in water demand
3. Explain the factors affecting per capita demand of a city
4. Identify a suitable method for prediction future population of a rapidly growing city

Course Outcome 2(CO2):

1. List the different groundwater sources available
2. Explain the factors influencing the selection of a particular source of water for a town
3. Show the importance of selection of an appropriate site for a river intake

Course Outcome3(CO3):

1. **Distinguish gravity system from pumping system of water supply**
2. A water supply scheme is to be designed for serving a population of 6.0 Lakhs, the storage reservoir is situated at 15 Km away from the city and the loss of head from the source to the city is 20m. Calculate the size of the supply main using Darcy and Hazen William formula. Take $f = 0.012$, $C_H = 130$ and maximum daily demand as 200 lpcd. The entire day demand is to be supplied in 10 hours.

Course Outcome 4 (CO4):

1. Demonstrate the procedure for fixing biological character for water
2. Distinguish safe water from wholesome water
3. Identify the importance of chemical characters of water

Course Outcome 5 (CO5):

1. Describe the mechanisms of removal in filtration process
2. Explain the theory of chlorination and the factors affecting chlorination
3. Design a rapid sand filter to treat 10 million litres of raw water per day allowing 0.5% of filtered water for backwashing. Half hour per day is used for backwashing. Assume necessary data.

Course Outcome6(CO6):

1. Explain the merits of grid iron system over dead end system
2. Demonstrate the procedure for detecting leakages in a pipe main

3. A town with a population of 1 million has a continuous water supply. Average supply is 270 LPCD, the water being supplied by direct pumping. The total supply of 270 lpcd is phased as follows:

Time	Lpcd
5A.M to 11 A.M	90
11A.M to 3 P.M	54
3 P.M to 9 P.M	81
9 P.M to 12 Midnight	27
12 Midnight to 5 A.M	18

Water is supplied from the treatment plant at a uniform rate of 11.25 million litres per hour, for all the 24 hours. Find out the capacity of the reservoir required for distribution of water. Assume no loss or drawal from the trunk main

Concept Map

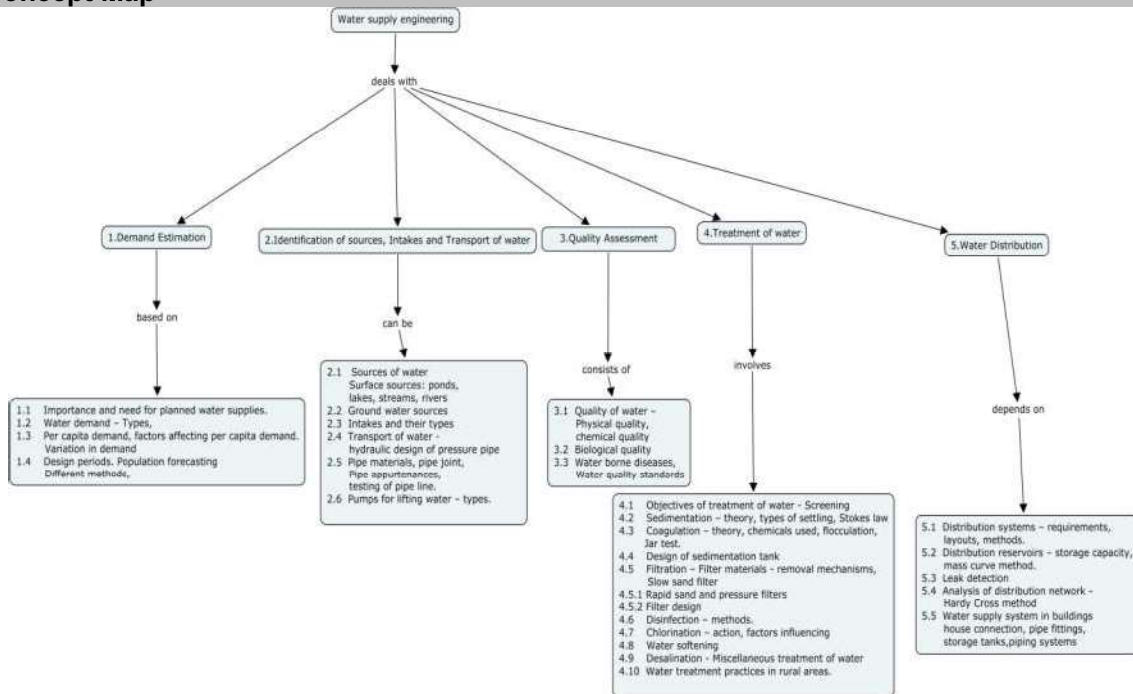

Syllabus

Demand Estimation - Importance and need for planned water supplies, water demand – Types, per capita demand, factors affecting per capita demand, variation in demand, Design periods, and population forecasting, different methods. **Identification of sources, Intakes and Transport of water** - Sources of water, Surface sources, ponds, lakes, streams, rivers, Ground water sources, occurrence, aquifers and their types, Wells - open wells, Tube wells, springs and their types, Infiltration galleries, Infiltration wells, Intakes and their types. Transport of water, hydraulic design of pressure pipe, Pipe materials, pipe joints, pipe appurtenances, testing of pipe line, Pumps for lifting water and its types. **Quality Assessment** - Quality of water, Physical quality, chemical quality, Biological quality, waterborne diseases, Water quality standards. **Treatment of water** – Screening - Sedimentation – theory, types of settling, Stokes law - Coagulation – theory, chemicals used, flocculation, Jar test, design of sedimentation tank, Filtration – removal mechanisms, filter media, types, slow sand, rapid sand and pressure filters, filter design. Disinfection, Chlorination – action, factors influencing, free chlorination, combined chlorination, ozonation, UV radiation, water softening, Desalination, Reverse Osmosis, Miscellaneous treatment of water, water treatment practices in rural areas, Reuse water quality

standards, Sludge reuse options. **Water Distribution** - Distribution systems – requirements, layouts and methods, Distribution reservoirs, storage capacity, mass curve method, Leak detection – Importance of Non-Revenue water, Analysis of distribution network, Hardy Cross method, Water supply system in buildings, house connection, pipe fittings, storage tanks, piping systems, Two pipe system, recycled water, Softwares – EPANET, WATER GEMS and WATER CAD.

Learning Resources

1. Garg S.K “Water Supply Engineering”, Khanna Publishers, 12th Edition, New Delhi 2015.
2. Steel E.W., “Water Supply and sewerage”, Mc Graw Hill Publishers, New Delhi. 2000.
3. Peavy, Rowe, Tchobanoglous, “Environmental Engineering”, McGraw Hill Publishers, New Delhi. 2006.
4. Birdie G.S and Birdie J.S “Water Supply and Sanitary Engineering” Dhatpat Rai Publishing Company New Delhi, 7th edition 2004
5. Gilbert M. Masters , “ Introduction to Environmental Engineering and Science”, third Edition, 2008
6. Manual on Water Supply and Treatment, CPHEEO, Ministry of Urban Development, Government of India, New Delhi, 2003
7. Chatterjee A.K. Water Supply, Waste Disposal and Environmental Engineering, 8th ed., New Delhi, Khanna Publisher. 2010
8. IS10500:2012 Water Quality Standards ,New Delhi 2012
9. IS SP 26 – Handbook on Water supply and Drainage (with special emphasis on plumbing).

Course Contents and Lecture Schedule

Module No.	Topic	No. of Lectures	Course Outcome
1	Demand Estimation		
1.1	Importance and need for planned water supplies.	1	CO1
1.2	Water demand – Types,	1	CO1
1.3	Per capita demand, factors affecting per capita demand. Variation in demand, Design periods.	1	CO1
1.4	Population forecasting – Different methods –Tutorials	2	CO1
2	Identification of sources, Intakes and Transport of water		
2.1	Sources of water: Surface sources: ponds, lakes, streams, rivers	1	CO2
2.2	Ground water sources	1	CO2
2.3	Intakes and their types	1	CO3
2.4	Transport of water - hydraulic design of pressure pipe- Tutorials	2	CO3
2.5	Pipe materials, pipe joint, Pipe appurtenances, testing of pipe line.	1	CO3
2.6	Pumps for lifting water – types.	1	CO3
3	Quality Assessment		
3.1	Quality of water – Physical quality, chemical quality	1	CO4
3.2	Biological quality	1	CO4
3.3	Water borne diseases, Water quality standards	1	CO4
4	Treatment of water		
4.1	Objectives of treatment of water – Screening	1	CO5
4.2	Sedimentation – theory, types of settling, Stokes law	1	CO5
4.3	Coagulation – theory, chemicals used, flocculation, Jar test.	1	CO5
4.4	Design of sedimentation tank – Tutorials	2	CO5
4.5	Filtration – Filter media - removal mechanisms, Slow sand filter	1	CO5

Module No.	Topic	No. of Lectures	Course Outcome
4.5.1	Rapid sand and pressure filters	1	CO5
4.5.2	Filter design – Tutorials	2	CO5
4.6	Disinfection – methods, Ozonation and UV radiation	1	CO5
4.7	Chlorination – action, factors influencing	1	CO5
4.8	Water softening	1	CO5
4.9	Desalination – Reverse Osmosis - Miscellaneous treatment of water	1	CO5
4.10	Water treatment practices in rural areas.	1	CO5
5	Water Distribution		
5.1	Distribution systems – requirements, layouts, methods.	1	CO6
5.2	Distribution reservoirs – storage capacity, mass curve method- Tutorials	2	CO6
5.3	Leak detection	1	CO6
5.4	Analysis of distribution network - Hardy Cross method – Tutorials	2	CO6
5.5	Water supply system in buildings – house connection, pipe fittings, storage tanks, piping systems, Two pipe system, recycled water, Softwares – EPANET, WATER GEMS and WATER CAD.	1	CO6
Total Hours (24 Hrs+12 Hrs)		36	

Course Designers:

- | | | |
|----|---------------------|--|
| 1. | Dr. T. Vel Rajan | tv civ@tce.edu |
| 2. | Mrs. S. Sivasangari | ssiciv@tce.edu |
| 3. | Ms.K.Keerthy | kkciv@tce.edu |

18CE350	PROGRAMMING FOR PROBLEM SOLVING
----------------	--

Category	L	T	P	Credit
ES	2	0	0	2

Preamble

This course enables students to learn about different problem-solving techniques and the design of computer solutions in a precise manner. The course emphasizes problem-solving techniques, design and development of algorithms and computer-programming skills. Upon completion of the course, the students will be able to master the principles of structured programming and demonstrate significant experience in problem solving.

Prerequisite

Nil

Course Outcomes

On the successful completion of the course students will be able to

CO Number	Course Outcome Statement	Weightage in %
CO1	Explain the program design and problem solving aspects used to provide a solution for the given problem and develop flowcharts for modelling the solution.	10
CO2	Develop algorithms for solving simple mathematical and engineering problems and examine the suitability of appropriate repetition and/or selection structures for given problems	25
CO3	Solve problems related to matrix manipulations using array processing techniques.	15
CO4	Construct solutions for string manipulation and numeric problems using modularization or recursion concepts as applicable.	20
CO5	Develop algorithms and programs for solving various searching and sorting problems.	15
CO6	Build programs for the storage, retrieval and processing of data using structures and files.	15

CO Mapping with CDIO Curriculum Framework

CO #	TCE Proficiency Scale	Learning Domain Level			CDIO Curricular Components (X.Y.Z)
		Cognitive	Affective	Psychomotor	
CO1	TPS2	Understand	Respond	Guided Response	1.2,2.1.1,2.1.2
CO2	TPS3	Apply	Value	Mechanism	1.2 ,2.1.5, 2.5.1, 4.5.3
CO3	TPS3	Apply	Value	Mechanism	1.2,2.1.5, 2.5.1, 4.5.3
CO4	TPS3	Apply	Value	Mechanism	1.2,2.1.5,2.5.1, 4.5.3
CO5	TPS3	Apply	Value	Mechanism	1.2, 2.1.5,2.4.7, 2.5.1, 4.5.3
CO6	TPS3	Apply	Value	Mechanism	1.2, 2.1.5, 2.5.1, 4.5.3

Mapping with Programme Outcomes and Programme Specific Outcome

COs	PO1	PO2	PO3	PO4	PO5	PO6	PO7	PO8	PO9	PO 10	PO 11	PO 12	PSO 1	PSO 2
CO1	M	L			L								L	
CO2	S	M	L		L				L			L	M	
CO3	S	M	L		L				L			L	M	
CO4	S	M	L		L				L			L	M	
CO5	S	M	L		L				L			L	M	
CO6	S	M	L		L				L			L	M	

S- Strong; M-Medium; L-Low

Assessment Pattern: Cognitive Domain

Cognitive Levels	Continuous Assessment Tests			Assignment			Terminal Examination
	1	2	3	1	2	3	
Remember	20	10	10	-	-	-	10
Understand	30	30	30	20	10	10	30
Apply	50	60	60	80	90	90	60
Analyse	-	-	-	-	-	-	-
Evaluate	-	-	-	-	-	-	-
Create	-	-	-	-	-	-	-

Assessment Pattern: Psychomotor

Psychomotor Skill	Mini project / Assignment / Practical Component
Perception	-
Set	-
Guided Response	10
Mechanism	90
Complex Overt Responses	-
Adaptation	-
Origination	-

Sample Questions for Course Outcome Assessment**Course Outcome1(CO1):**

1. Explain the pseudo code to exchange the value of variables without using third variable (Understand)
2. Draw the flowchart to find the average among three numbers (Understand)
3. Give the pseudo code for calculating the net salary considering the allowances and deductions.(Understand)

Course Outcome2(CO2):

1. Write a program to check whether a number is prime or not (Apply)
2. Write a C Program to find the sum of digits of a given integer. (Apply)
3. Write a C Program to find all roots of a Quadratic Equation (Apply)

Course Outcome 3(CO3):

1. Develop a C Program to generate multiplication table (Apply)
2. Give an algorithm to find the inverse of a matrix. (Apply)

3. Write a C Program to calculate average using Arrays (Apply)

Course Outcome 4 (CO4):

1. Develop a C Program to display prime numbers between intervals using function (Apply)
2. Develop a C Program to check whether the given string is palindrome using function. (Apply)
3. Develop a C Program to calculate the power using recursion (Apply)

Course Outcome 5 (CO5):

1. Given an array arr = {5, 10, 87, 43, 29} and key = 43; How many iterations are done until the element is found in Binary Search? (Apply)
2. Demonstrate the working of bubble sort on the following set of numbers : {22, 67, 12, 3, 76, 41, 59, 37} (Apply).
3. Write a C program to sort the numbers using selection sort. (Apply).

Course Outcome 6(CO6):

1. Develop a C Program to read a line of text from a file and display the same (Apply).
2. Write a C Program to count the number of vowels in a text file (Apply).
3. Write a C Program to add two Complex Numbers by using structure (Apply)

Concept Map

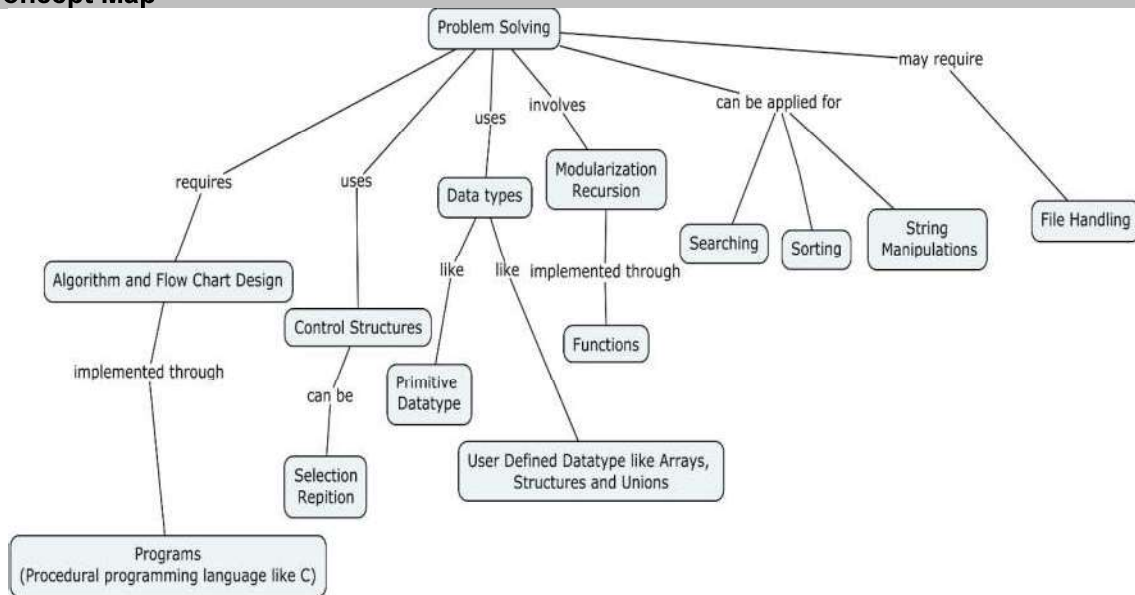

Syllabus

Introduction to Computer Problem Solving – Problem solving aspect –Top-down Design – Implementation of Algorithm – Flowcharts. **Fundamentals Algorithms** - Exchanging values of variables, Counting. **Fundamentals of Programming** – Data types, Input and Output Statements, Operators and Expressions , Control structures - Selection Control Structures - Repetition Control Structures - Summation of set of numbers -- Sine function computation - - Reversing the digits of an Integer, Factoring Methods - Finding square root of a number -The smallest divisor of an integer, Generating Prime numbers. **Array Techniques**–Use of 1D and 2D arrays, Finding the maximum number in a set - Finding kth smallest number, Partitioning an array - Matrix manipulations – Addition, Multiplication and Transpose. **Functions and Recursion**-Function Declaration, definition and execution, Factorial computation, Fibonacci sequence generation, String Manipulations – comparison between strings, copying of strings, searching for substring. **Sorting and Searching Algorithms** – Bubble sort, sorting by selection, Linear

Search, Binary search. **Structures and Files**—Structures – Storing and accessing elements, Array of Structures – Files – Read and Write operations on text files.

Learning Resources

1. R.G Dromey, How to solve it by Computer, Pearson Education, Delhi, 2008.
2. Lesley Anne Robertson Simple Program Design, A Step-by-Step Approach, 5th Edition, Thomson, 2007.
3. [Yashavant Kanetkar](#) , Let Us C, 16th Edition, BPB Publications, 2017.
4. Yashavant kanetkar, Computer System and Programming In C, First Edition, BPB Publications 2018.
5. Balagurusamy E , Programming In ANSI C , Seventh Edition, Tata Mc-Graw Hill, 2017.
6. Herbert Schildt, C: The Complete Reference, Fourth Edition, Tata Mc-Graw Hill, 2000.

Course Contents and Lecture Schedule

Module No.	Topic	No. of Lectures	Course Outcome
1	Introduction to Computer Problem Solving (2)		
1.1	Problem Solving aspect, Top-Down Design, Implementation of an Algorithm	1	CO1
1.2	Fundamental Algorithms - Exchanging the values of two variables, Counting	1	CO1
2	Fundamentals of Programming and Factoring Methods (6)		
2.1	Data types, Input and Output Statements, Operators and Expressions	1	CO2
2.2	Control Structures - Selection Control Structures, Repetition Control Structures	2	CO2
2.3	Summation of a set of numbers, Sine function computation, Reversing the digits of an Integer.	1	CO2
2.4	Factoring Methods - Finding square root of a number - The smallest divisor of an integer	1	CO2
2.5	Generating Prime numbers	1	CO2
3	Array Techniques (4)		
3.1	Use of 1D and 2D arrays	1	CO3
3.2	Finding maximum and the minimum value in a set	1	CO3
3.3	Finding k th smallest number, Partitioning an array	1	CO3
3.4	Matrix manipulations – Addition, Multiplication and Transpose of matrices	1	CO3
4	Functions and recursion (5)		
4.1	Function Declaration, definition and execution	1	CO4
4.2	Factorial Computation	1	CO4
4.3	Fibonacci sequence generation	1	CO4
4.4	String manipulations – Comparison between strings, Copying of strings, Searching for substring	2	CO4
5	Sorting and Searching Algorithms (3)		
5.1	Bubble Sort, Sorting by selection	2	CO5
5.2	Linear Search, Binary Search	1	CO5
6	Structures and Files (4)		

Module No.	Topic	No. of Lectures	Course Outcome
6.1	Structures- storing and accessing elements	1	CO6
6.2	Array of structures	1	CO6
6.3	Files – Read and Write operations on text files	2	CO6
	Total	24	

Course Designers:

1. Mrs.B.Subbulakshmi bscse@tce.edu
2. Dr.M.Vijayalakshmi mviji@tce.edu

18CE370	COMPUTER AIDED DRAFTING LAB	Category	L	T	P	Credit
		PC	--	--	2	1

Preamble

This laboratory course work is intended to provide students with opportunities to acquire knowledge and to develop skills in drafting the different views of the components of the building structures using available drafting software and capable of viewing and drawing the plan, elevation and section of the different types of the building. The course shows how to use AutoCAD to set up drawings and construct lines, circles, arcs, other shapes, geometric constructions, and text. Students will use display and editing techniques as well to obtain information about their drawings and work with drawing files. This course also introduces recommended drafting standards for students to use for properly preparing drawings with AutoCAD.

Prerequisites

18ME160 – Engineering Graphics;
18CE260 – Building Materials and Technology

Course Outcomes

On the successful completion of the course students will be able to

CO Number	Course Outcome Statement	Weightage*** in %
CO1	Draw 2D drawing using basic drawing and editing commands	15
CO2	Manage the files, views, layers, display commands	15
CO3	Create symbols using the concept of blocks, W blocks & Xref	25
CO4	Publish and plot the drawing with annotations & dimensioning, using the concept of paper space & model space and specific scales.	25
CO5	Draw and edit 3D models using UCS	20

*** Weightage depends on Bloom's Level, number of contact hours.

CO Mapping with CDIO Curriculum Framework

CO's	TCE Proficiency Scale	Learning Domain Level			CDIO Curricular Components (X.Y.Z)
		Cognitive	Affective	Psychomotor	
CO1	TPS1	Remember	Receive	Perception, Set	1.1.1,1.2,2.1.1,2.1.2,3.2.5
CO2	TPS3	Apply	Value	Mechanism	1.1.1,1.2,2.1.1,2.1.2,3.2.5
CO3	TPS3	Apply	Value	Mechanism	1.1.1,1.2,2.1.1,2.1.2,3.2.5
CO4	TPS3	Apply	Value	Mechanism	1.1.1,1.2,2.1.1,2.1.2,3.2.5
CO5	TPS3	Apply	Value	Mechanism	1.1.1,1.2,2.1.1,2.1.2,3.2.5

Mapping with Programme Outcomes and Programme Specific Outcomes

COs	PO1	PO2	PO3	PO4	PO5	PO6	PO7	PO8	PO9	PO 10	PO 11	PO 12	PSO1	PSO2
CO1	S	S	--	--	S	M	--	--	--	L	--	--	--	--
CO2	S	S	--	--	S	M	--	--	--	L	--	--	--	--
CO3	S	S	--	--	S	M	--	--	--	L	--	--	--	--
CO4	S	S	L	--	S	M	--	S	S	M	--	--	M	L
CO5	S	S	L	--	S	M	S	S	S	M	--	--	M	L

S- Strong; M-Medium; L-Low

Assessment Pattern: Cognitive Domain

Cognitive Levels	Model Examination	Terminal Examination
Remember	10	10
Understand	10	10
Apply	80	80
Analyse	--	--
Evaluate	--	--
Create	--	--

Assessment Pattern: Psychomotor

Psychomotor Skill	Mini project /Practical Component/Observation
Perception	10
Set	--
Guided Response	20
Mechanism	70
Complex Overt Responses	--
Adaptation	--
Origination	--

List of Experiments/Activities with CO Mapping

S.No	Description	No. of hours	Course Outcome
	2D Drawings		
1	Fully panelled door / window / Partially panelled and partially glazed door / windows – plan, section & elevations with necessary dimensions and annotations	2	CO1,CO4
2	Single room building with necessary plan section and elevations	2	CO1,CO2, CO4
3	Single floor residential building plan with furniture usage of layers	2	CO1,CO2, CO3, CO4
4	Industrial Structures with cross sectional layer display	2	CO1,CO2, CO3, CO4
5	Fink / fink fan type steel trusses – detailing with various scale – usage of paper space & model space.	2	CO1,CO2, CO3, CO4

6	Two storey residential building with plan, section and elevation using blocks	2	CO1, CO2, CO3, CO4
7	College campus-Masterplan using the concept of Xref	4	CO1, CO2, CO3, CO4
9	Dog legged stair case – necessary views	2	CO1, CO2, CO3, CO4
10	Design of a residential building for a given area and draw plan, section and elevation.	2	CO1, CO2, CO3, CO4
	3D Drawings		
12	3D modelling of a residential building and generating various views	4	CO1, CO4, CO5
	Total Hours	24	

Learning Resources

1. V.B. Sikka, A Course in Civil Engineering Drawing, 4th edition, S.K. Kataria & Sons, New Delhi, 2017.
2. M.G. Shah, C.M. Kale & S.Y.Patki, Building Drawing with an Integrated Approach to Built Environment, 4th edition, Tata McGraw Hill Publishing Co. Ltd. New Delhi, 2002.
3. Geogre Omura and Brain C. Benton, Mastering AutoCAD and AutoCAD LT, J. Wiley & Sons, 2018
4. Ramsey and Sleeper, Architectural Graphic Standards Student Edition, J. Wiley & Sons, 2017

Websites:

1. <https://www.mycadsite.com/tutorials/index.html>
2. <https://www.cadtutor.net/tutorials/autocad>
3. http://www.caddprimer.com/AutoCAD_training_tutorial/AutoCAD_training_lessons.html
4. <http://www.autocadmark.com>
5. <http://www.autocadtutorials.net>

Course Designers

1. Dr. S. Arul Mary samciv@tce.edu
2. Ms. G. Celine Reena celinereena@tce.edu

18ES390	DESIGN THINKING	Category	L	T	P	Credit
		ES	1	-	2	2

Preamble

Design has been defined as a “systematic, intelligent process in which designers generate, evaluate, and specify concepts for devices, systems, or processes whose form and function achieve clients’ objectives or users’ needs while satisfying a specified set of constraints”. Human-centered design is defined as a process and a set of techniques used to create new solutions for the world. Solutions include products, services, environments, organizations, and modes of interaction. The reason this process is called “human-centered” is because it starts with the people we are designing for. This course facilitates the development of students’ professional skills through their team engagement in developing conceptual design for a local community problem.

Prerequisite

Nil

Course Outcomes

On the successful completion of the course students will be able to

CO Number	Course Outcome Statement	Weightage in %
CO1	Identify a specific social need to be addressed	20
CO2	Identify stakeholder’s requirements for the societal project	20
CO3	Develop measurable criteria in which design concepts can be evaluated	10
CO4	Develop prototypes of multiple concepts using user’s feedback	30
CO5	Select the best design solution among the potential solutions with its functional decomposition	20

CO Mapping with CDIO Curriculum Framework

CO #	TCE Proficiency Scale	Learning Domain Level			CDIO Curricular Components (X.Y.Z)
		Cognitive	Affective	Psychomotor	
CO1	TPS3	Apply	Value	Mechanism	1.1, 1.2, 2.1.1, 3.1.2, 3.2.3, 3.2.6, 4.1.2
CO2	TPS3	Apply	Value	Mechanism	1.1, 1.2, 2.1.2, 2.5.1, 2.5.2, 3.1.2, 3.2.3, 3.2.6, 4.1.2
CO3	TPS3	Apply	Value	Mechanism	1.1, 1.2, 2.1.3, 3.1.2, 3.2.3, 3.2.6, 4.1.2, 4.3.1
CO4	TPS3	Apply	Value	Mechanism	1.1, 1.2, 2.1.4, 3.1.2, 3.2.3, 3.2.6, 4.1.2, 4.4.1
CO5	TPS5	Evaluate	Organise	Adaptation	1.1, 1.2, 2.1.5, 3.1.2, 3.2.3, 3.2.6, 4.1.2, 4.4.1

Mapping with Programme Outcomes and Programme Specific Outcomes

COs	PO1	PO2	PO3	PO4	PO5	PO6	PO7	PO8	PO9	PO10	PO11	PO12
CO1	S	M	L	-	-	M	M	M	L	M	M	S
CO2	S	M	L	-	-	M	M	M	L	M	M	S
CO3	S	M	L	-	-	M	M	M	L	M	M	S
CO4	S	M	L	-	M	M	M	M	L	M	M	S
CO5	S	S	M	L	M	M	M	M	L	M	M	S

S- Strong; M-Medium; L-Low

Assessment Pattern: Cognitive Domain

Phases	Deliverables	Marks	Course Outcomes
Continuous Assessment			
Review 1 – Problem Identification	Technical Report	10	CO1 and CO2
Review 2 – Specification Development	Technical Report	20	CO3
Review 3 -Conceptual Design	Technical Report	20	CO4 and CO5
End-Semester Examination			
Demonstration	Prototype	60	CO1, CO2, CO3, CO4 and CO5
Poster Presentation	Poster	40	

- Reports are to be submitted at each review. The report and presentation will be evaluated based on Rubrics
- Demonstration and Poster presentation will be evaluated by two faculty members nominated by their respective Head of the Department.

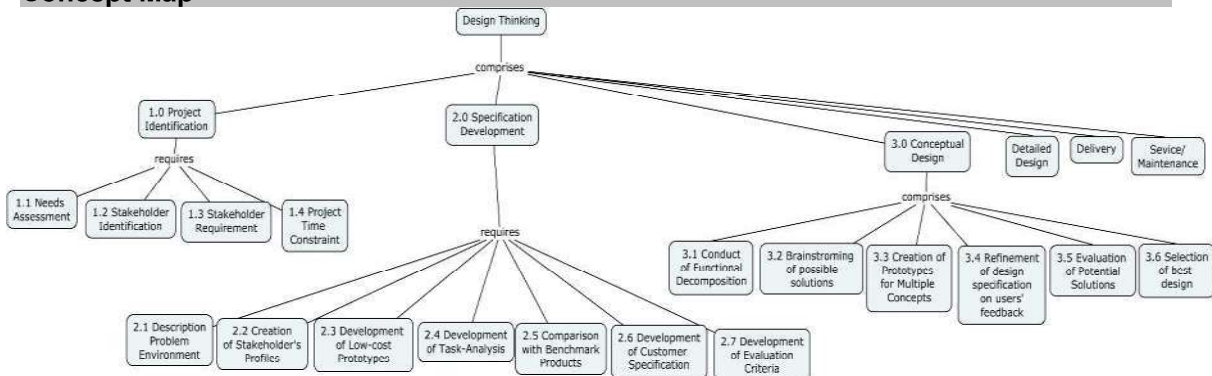
Concept Map**Syllabus**

1.0 Project Identification: Needs Assessment, Stakeholder Identification, Stakeholder Requirement Project Time Constraint.

2.0 Specification Development: Description Problem Environment, Creation of Stakeholder's Profiles Development of Low-cost Prototypes, Development of Task-Analysis, Comparison with Benchmark Products, Development of Customer Specification, Development of Evaluation Criteria,

3.0 Conceptual Design: Conduct of Functional Decomposition, Brainstroming of possible solutions, Creation of Prototypes for Multiple Concepts, Refinement of Design Specification on users' feedback, Evaluation of Potential Solutions, Selection of best design.

Learning Resources

1. Learning Material prepared by TCE faculty members
2. <https://www.ideo.com/>
3. <https://engineering.purdue.edu/EPICS>

Course Contents and Lecture Schedule

Module No.	Topic	No. of Hours		Course Outcome
		In-Class	Hands-on	
1.	Project Identification: Introduction to Human-Centered Design	1	-	CO1
1.1	Needs Assessment	1	2	CO1
1.2	Identification of Stakeholders	1	2	CO2
1.3	Identification of Stakeholder Requirements		2	CO2
1.4	Project Time Constraint	1	2	CO2
2.	Specification Development			
2.1	Description Problem Environment	1	2	CO3
2.2	Creation of Stakeholder's Profiles		2	CO3
2.3	Development of Low-cost Prototypes	1	2	CO3
2.4	Development of Task-Analysis	1	2	CO3
2.5	Comparison with Benchmark Products	1	2	CO3
2.6	Development of Customer Specification		2	CO3
2.7	Development of Evaluation Criteria	1	2	CO3
3.	Conceptual Design			
3.1	Conduct of Functional Decomposition	1	2	CO4
3.2	Brainstroming of possible solutions	1	2	CO5
3.3	Creation of Prototypes for Multiple Concepts	1	2	CO5
3.4	Refinement of design Specification on users' feedback		2	CO6
3.5	Evaluation of Potential Solutions	1	2	CO6
3.6	Selection of best design		2	CO6
	Total	12	34	

Course Designers:

1. Dr.S.J.Thiruvengadam sjtece@tce.edu
2. Dr.S.Saravana Perumaal sspmech@tce.edu

18 CE 410	PROBABILITY AND STATISTICS	Category	L	T	P	Credit
		BS	3	0	0	3

Preamble

Statistics as a subject is a science of learning from data and provides tools for making decisions when conditions of uncertainty prevail. Statistical techniques are an important tool in these activities because they provide the engineer with both descriptive and analytical methods for dealing with the variability in observed data. A civil engineer plays a significant role in designing and developing new projects and improving systems and processes. This course is designed to impart the knowledge and understanding of the statistical techniques to Civil engineers and to apply them in their areas of specialization.

Prerequisite

Basics of Probability

Course Outcomes

On the successful completion of the course students will be able to

CO Number	Course Outcome Statement	Weightage*** in %
CO1	Use Bayes formula to invert conditional probabilities.	15%
CO2	Identify expectation , moments, moment generating functions	15%
CO3	Apply discrete and continuous distributions to determine mass and density functions and concept of stochastic process	20%
CO4	Describe the concept of least square method in fitting linear regression curves	15%
CO5	compute population estimators	15%
CO6	Explain the test of hypothesis for small and large samples by using various tests like t-test, F-test, z-test and chi-square test	20%

CO Mapping with CDIO Curriculum Framework

CO #	TCE Proficiency Scale	Learning Domain Level			CDIO Curricular Components (X.Y.Z)
		Cognitive	Affective	Psychomotor	
CO1	TPS3	K3	A3		1.1.1,2.1.4
CO2	TPS2	K2	A2		1.1.1,2.1.4
CO3	TPS3	K3	A3		1.1.1,2.1.4
CO4	TPS1	K1	A1		1.1.1,2.1.4,2.1.5
CO5	TPS3	K3	A3		1.1.1,2.1.4,2.1.5
CO6	TPS3	K3	A3		1.1.1,2.1.5,2.2.1,2.2.4

Mapping with Programme Outcomes and Programme Specific Outcomes

Cos	PO1	PO2	PO3	PO4	PO5	PO6	PO7	PO8	PO9	PO10	PO11	PO12	PSO1	PSO2	PSO3
CO1	M	L		L								M			
CO2	S	S	S	M		S	M	S			M		S	S	
CO3	S	S	S	S	S		M				S	S	M	S	M
CO4	M	L	M	M		M					M				
CO5	S	M	M	S			S	M		M	S	S	S	S	
CO6		S	S	S	S		S	S		M	S			S	S

S- Strong; M-Medium; L-Low

Assessment Pattern: Cognitive Domain

Cognitive Levels	Continuous Assessment Tests			Assignment			Terminal Examination
	1	2	3	1	2	3	
Remember	10	10	10				-
Understand	30	30	30				30
Apply	60	60	60	100	100	100	70
Analyse							
Evaluate							
Create							

Assessment Pattern: Psychomotor

Psychomotor Skill	Miniproject /Assignment/Practical Component
Perception	
Set	
Guided Response	
Mechanism	
Complex Overt Responses	
Adaptation	
Origination	

Sample Questions for Course Outcome Assessment****Course Outcome1 (CO1):**

1. A and B toss affair coin alternately with the understanding that the one who obtains the head first wins. If A starts, calculate his chance of winning
2. If A and B are mutually exclusive events then prove that $(P(B/A) = 0$
3. A box contains 2000 components of which 5% are defective. A second box contains 50 components of which 40% are defective. Two other boxes contain 1000 components, each with 10% defective components. We select at random one of the above boxes and remove from it at random a single component.(a) calculate the probability that the component is defective? (b) If the selected component is defective, then calculate the probability that it was drawn from box 2?

Course Outcome 2 (CO2):

1. Identify the following as discrete or continuous random variable
 - a. Total number of gold medals won by India in Asian games 2018
 - b. Height of the ocean's tide at Kanyakumari
 - c. Number of deer born per year in a state wildlife preserve
 - d. The amount of water released from Mettur dam this month
2. Identify the moment generating function of the random variable X given the probability density function $f(x) = 2e^{-2x}; x > 0$
3. Explain the statistics of random processes

Course Outcome 3(CO3):

1. If you apply brakes, compute the probability that you will brake to a stop within 40 feet or less? Within 50 feet or less
2. Assume that the chance of an individual coal miner being killed in an accident during a year is 1/1400. Calculate the probability that in a mine employing 350 miners, there will be at least one fatal accident in a year by Poisson distribution
3. At a certain examination 10% of the students who appeared for the paper in Statistics got less than 30 marks and 97% of the students got less than 62 marks. Assuming the

distribution is normal, calculate the mean and Standard deviation of the distribution.

Course Outcome 4 (CO4):

1. Describe the method of least squares in fitting a regression curve
2. Match least square method to fit an exponential curve of the form $Y = ab^X$ to the following data

X	1	2	3	4	5	6	7	8
Y	1.0	1.2	1.8	2.5	3.6	4.7	6.6	9.1

3. The two regression lines are $4x - 5y + 53 = 0$ and $20x - 9y = 107$ and variance of X is 25. know the values correlation coefficient and variance of Y

Course Outcome 5 (CO5):

1. List the properties of estimation
2. $X_1, X_2,$ and X_3 is a random sample of size 3 from a population with mean μ and variance σ^2 . T_1, T_2, T_3 are the estimators used to estimate the mean value μ , where $T_1 = X_1 + X_2 - X_3$; $T_2 = 2X_1 + 3X_3 - 4X_2$ and $T_3 = 1/3(\lambda X_1 + X_2 + X_3)$ (i) Are T_1 and T_2 unbiased estimators? Compute λ such that T_3 is an unbiased estimator for μ
3. Calculate the maximum likelihood estimator for λ when $f(x; \lambda)$ is the Poisson distribution

Course Outcome 6(CO6):

1. Explain Null hypothesis an alternate hypothesis
2. Twenty people were attacked by a disease and only 18 survived. Will you reject the hypothesis that the survival rate if attacked by the disease is 85% in favour to the hypothesis that it is more at 5% level?
3. The demand for a particular spare part in a factory found to vary from day-to-day. In a sample study the following information was obtained.

Days	Mon	Tues	Wedn	Thurs	Fri	Sat
No. of parts demanded	1124	1125	1110	1120	1126	1115

Test the hypothesis that number of parts demanded does not depend on the day of the week.

Concept Map

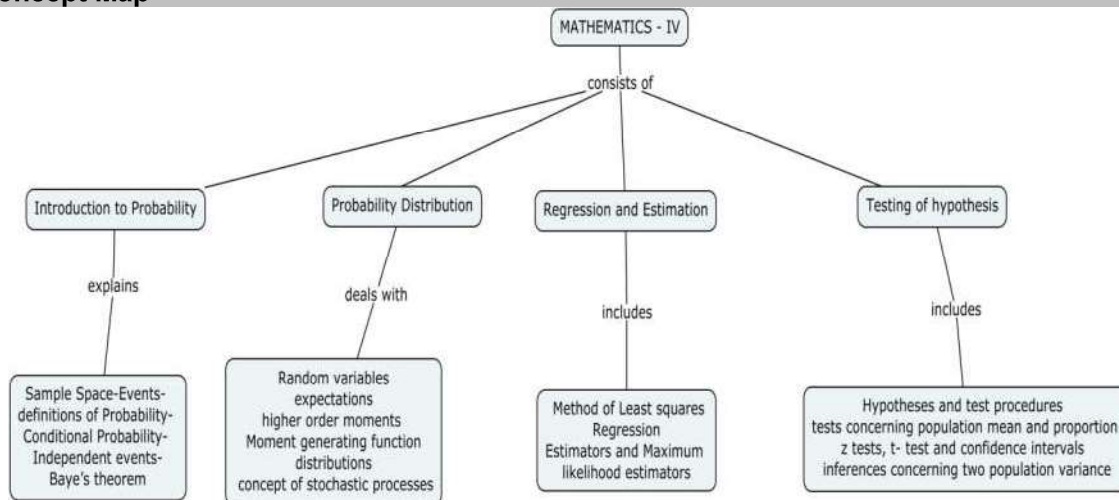

Syllabus

Introduction to Probability: Population-Sample Space-Events- definitions of Probability-Axioms of probability-Conditional Probability- Independent events-Bayes's theorem- **Probability Distribution:** Random variables- discrete and continuous random variables- expectations-higher order moments- Moment generating function- Binomial-Poisson-Normal distributions-Elementary concepts related to stochastic processes- **Regression and Estimation:** Least square estimation- Method of Least squares-Regression-linear regression-Estimators and their properties-Sufficient statistic and Maximum likelihood estimators- **Test of Hypothesis:** Hypotheses and test procedures - tests concerning a population mean - tests concerning a population proportion - z tests and confidence intervals for a difference between two Population means - the two-sample *t* Test and confidence interval - inferences concerning a difference between population proportion - inferences concerning two population variance

Learning Resources

1. **Jay L. Devore**, "Probability and Statistics for Engineering and the Sciences" (English) Eighth Edition, Cengage Learning India Pvt Ltd, New Delhi, 2012.
Probability-Sections: 2.1, 2.2, 2.3, 2.4, 2.5
Probability distributions-Sections: 3.1, 3.2, 3.3, 3.4, 3.6, 4.3
Test of Hypothesis-Sections: 8.1, 8.2, 8.3, 9.1, 9.2, 9.3, 9.4, 9.5
2. **S.C.Gupta, V.K.Kapoor**, " Fundamentals of Mathematical Statistics", Tenth Edition, Sultan Chand and Sons Educational Publishers, New Delhi, 2002
Method of Least Square-Sections: 9.1, 9.1.1, 9.1.2
Estimation- Sections: 10.7, 7.1, 7.2, 7.3, 7.4
3. **Glyn James**. " Advanced Modern Engineering Mathematics", Third Edition, Pearson Education, New Delhi, 2016
4. **Miller, Fan**, "Probability and Statistics for Engineers", Prentice Hall of India, 2001.

Course Contents and Lecture Schedule

Module No.	Topic	No. of Hours	Course Outcome
1.	Introduction to Probability		
1.1	Sample space and events	1	CO1
1.2	Definition and axioms of probability	1	CO1
1.3	Conditional Probability, Independent events	2	CO1
1.4	Baye's theorem	2	CO1
2.	Probability Distribution		
2.1	Random variables, discrete and continuous random variables	2	CO2
2.2	expectations	1	CO2
2.3	higher order moments	2	CO2
2.4	Moment generating function	1	CO2
2.5	Binomial, Poisson distributions	2	CO3
2.6	Normal distribution	1	CO3
2.7	concepts related to stochastic processes	1	CO3
3.	Regression and Estimation		
3.1	Least square estimation	1	CO4
3.2	Method of Least squares, Regression	2	CO4
3.3	Linear regression	1	CO4
3.4	Estimators and their properties	2	CO5
3.5	Maximum likelihood estimators	2	CO5
4.	Test of Hypothesis		
4.1	Hypotheses and test procedures	2	CO6

4.2	Tests concerning a population mean	2	CO6
4.3	Tests concerning a population proportion	2	CO6
4.4	Z tests and confidence intervals for a difference between two Population means	2	CO6
4.5	The two-sample t Test and confidence interval	2	CO6
4.6	Inferences concerning a difference between population proportion	1	CO6
4.7	Inferences concerning two population variance	1	CO6
Total		36	

Course Designers:

1. Prof. P.Subramanian psmat@tce.edu
2. Dr. M.sivanandha Saraswathy sivanandha@tce.edu
3. Dr.N.Chitra ncmat@tce.edu

18CE420	STRUCTURAL ANALYSIS	Category	L	T	P	Credit
		PC	2	1	0	3

Preamble

This course offers the various methods of analysis for indeterminate beams and portal frames. It aims at determination of end moments and constructing shear force and bending moment diagrams for the beams and frames. Also, ILD for indeterminate beams will be dealt with.

Prerequisite

Fundamentals of Engineering Mechanics and Mechanics of Solids.

Course Outcomes

On the successful completion of the course students will be able to

CO Number	Course Outcome Statement	Weightage*** in %
CO1	Construct ILD for indeterminate beams.	16
CO2	Analyse propped cantilever, fixed beam and frames by strain energy method.	16
CO3	Analyse propped cantilever, fixed beams and continuous beams using theorem of three moments.	14
CO4	Analyse beams and frames by slope deflection method.	14
CO5	Analyse beams and frames by moment distribution method.	20
CO6	Analyse beams and frames by matrix stiffness method.	20

*** Weightage depends on Bloom's Level, Number of Contact Hours.

CO Mapping with CDIO Curriculum Framework

CO #	TCE Proficiency Scale	Learning Domain Level			CDIO Curricular Components (X.Y.Z)
		Cognitive	Affective	Psychomotor	
CO1	TPS3	Apply	Value	Mechanism	1.1.1,1.1.2,1.2,2.1.1.
CO2	TPS3	Apply	Value	Mechanism	1.1.1, 1.2, 2.1.1,2.3.1.
CO3	TPS3	Apply	Value	Mechanism	1.1.1,1.1.2,1.2,2.1.1,2.1.5.
CO4	TPS3	Apply	Value	Mechanism	1.1.1,1.2,2.1.1,2.1.5,3.2.5.
CO5	TPS3	Apply	Value	Mechanism	1.1.1,1.1.2,1.2,2.1.1,2.1.5,2.3.1,2.4.4.
CO6	TPS3	Apply	Value	Mechanism	1.1.1,1.1.2,1.2,1.3,2.1.1,2.1.5,2.3.1,2.4.3, 4.1.2.

Mapping with Programme Outcomes and Programme Specific Outcomes

Cos	PO1	PO2	PO3	PO4	PO5	PO6	PO7	PO8	PO9	PO10	PO11	PO12	PSO1	PSO2
CO1	S	S	M	-	-	L	-	-	-	M	-	S	M	L
CO2	M	M	-	-	-	-	-	-	-	-	L	-	M	L
CO3	S	S	-	-	-	-	-	-	-	-	-	S	M	L
CO4	S	S	-	M	-	M	-	-	-	-	-	S	M	M
CO5	S	S	-	-	M	L	M	-	M	S	-	S	M	M
CO6	S	S	M	-	M	L	M	-	-	-	-	S	M	M

S- Strong; M-Medium; L-Low

Assessment Pattern: Cognitive Domain

Cognitive Levels	Continuous Assessment Tests			Assignment			Terminal Examination
	1	2	3	1	2	3	
Remember	10	10	10	-	-	-	10
Understand	10	10	10	-	-	-	10
Apply	80	80	80	100	100	100	80
Analyse							
Evaluate							
Create							

Assessment Pattern: Psychomotor

Psychomotor Skill	Assignment
Perception	-
Set	50
Guided Response	50
Mechanism	-
Complex Overt Responses	-
Adaptation	-
Origination	-

Sample Questions for Course Outcome Assessment****Course Outcome 1(CO1):**

1. Sketch the shape of influence line diagram for shear force at any section of a two span continuous beam of two equal spans
2. Draw the influence line diagram for reaction at A and B of a two span continuous beam ABC with simply supported ends having length $AB=BC = 6m$ Compute ILD ordinates at 2m intervals.
3. Derive the influence line diagram for the prop reaction at B of a propped cantilever. Using the influence diagram, determine the prop reaction if the beam has a span of 8m and subjected to three point loads of 15kN, 10kN and 20kN at 2m, 4m and 6.5m from the propped end.

Course Outcome 2(CO2):

1. A propped cantilever beam AB of span 6m is subjected to a uniformly distributed load of 15kN/m over the entire span and point loads of 10kN and 15kN at 2m and 4m respectively from the propped end B. Determine the prop reaction using strain energy method.
2. A propped cantilever beam AB of span 6m is subjected to a uniformly distributed load of 15kN/m over the entire span and a point load of 10kN at 2m from the propped end B. Determine the prop reaction using strain energy method.
3. A two span continuous beam of equal spans is subjected to a uniformly distributed load of 20kN/m over the entire length of both spans. Determine the reaction at mid support by strain energy method.

Course Outcome 3(CO3):

1. A circular rod of 100mm diameter and 500mm length is subjected to an axial force of A continuous beam ABC fixed at end A and continuous over supports B and C. The span $AB=8m$ carries a uniformly distributed load of 6kN/m over the entire span. The span $BC=5m$ carries a non-central concentrated load of 15kN acting at a distance of

- 3m from support B. Analyse the beam and draw bending moment diagram using theorem of three moments. (EI is constant)
2. A continuous beam ABCD simply supported at ends A and D and continuous over supports B and C. The span AB=5m carries a non central concentrated load of 15kN at 2m from A. The span BC=4m carries a uniformly distributed load of 6kN/m over the entire span. The span CD=5m carries a central concentrated load of 10kN. Analyse the beam and draw bending moment diagram. Use theorem of three moments. (EI is constant)

Course Outcome 4 (CO4):

1. A continuous beam ABCD of 14 metres span fixed at ends A and D and continuous over supports B and C. The span AB=5m carries a central load of 10kN. The span BC=4m carries a uniformly distributed load of 4kN/m over the span BC. The span CD=5m carries a central load of 8kN. Analyse the beam using slope deflection method and draw the bending moment diagram. (EI is constant)
2. Analyze a rectangular portal frame ABCD with fixed end at A and hinged end at D having dimensions AB=6m, DC=4.0m, and the horizontal member BC=5.0m. The frame is loaded with a concentrated load of 60kN acting at a distance of 3.0 m from the rigid joint B on the member BC and a uniformly distributed load of 20kN/m over the entire length of the vertical member DC. Use slope deflection method and draw the bending moment diagram. (EI is constant)

Course Outcome 5 (CO5):

- 1 Calculate the end moments of a three span continuous beam ABCD of span AB=4.0m loaded with a uniformly distributed load of 20kN/m over the entire span, span BC=5.0m loaded with a point load of 40kN acting at 3.0m from B and span CD=5.0m loaded with 60kN acting at 2.0m from C with fixed ends at A and D. Use Moment distribution method.
- 2 Analyze a rectangular portal frame ABCD with fixed end at A and hinged end at D having dimensions AB=6m, DC=4.0m, and the horizontal member BC=5.0m. The frame is loaded with a concentrated load of 60kN acting at a distance of 3.0 m from the rigid joint B on the member BC and a uniformly distributed load of 20kN/m over the entire length of the vertical member DC. Use Moment distribution method.

Course Outcome 6 (CO6):

- 1 A continuous beam ABC fixed at end A, continuous over support B and freely supported at C. The span AB=6m carries a uniformly distributed load of 15kN/m over the entire span. The span BC=5m carries a non-central concentrated load of 20kN acting at a distance of 3m from support B. Analyse the beam by matrix stiffness method. (EI is constant). Draw the shear force and bending moment diagrams.
- 2 A portal frame of spans AB = 3m, BC = 4.5m and CD = 3m is subjected to a uniformly distributed load of 15kN/m over the entire span of BC. Analyse by matrix stiffness method and draw the bending moment diagram. MI of spans AB and CD : I and that of BC is 2I.

Concept Map

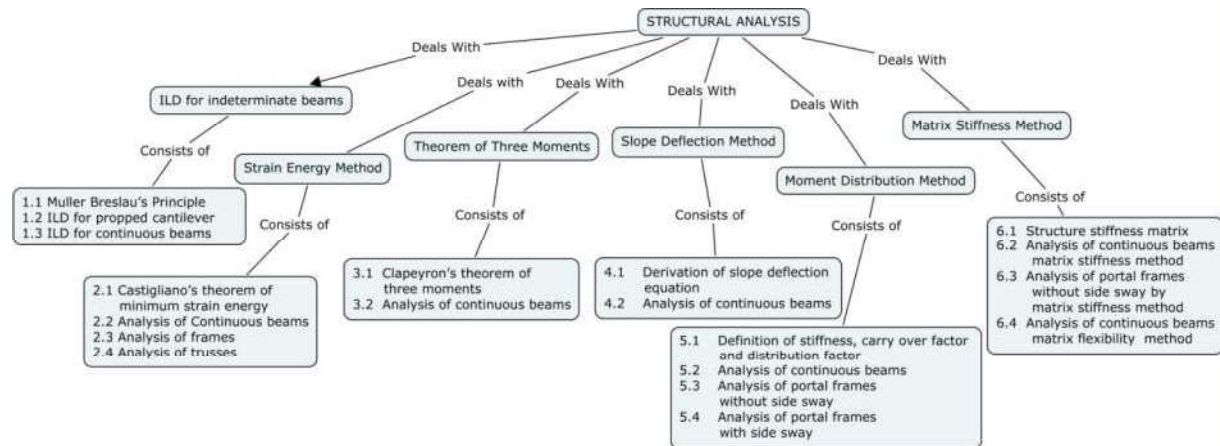

Syllabus

ILD for indeterminate beams: Muller Breslau’s principle – Influence line diagrams for propped cantilever and continuous beams **Strain Energy Method:** Introduction – Castigliano’s theorem of minimum strain energy – Analysis of propped cantilever and fixed beams, frames and trusses. **Theorem of Three Moments:** Clapeyron’s theorem of three moments - Analysis of continuous beams. **Slope Deflection Method:** Derivation of slope deflection equation – Analysis of continuous beams. **Moment Distribution Method:** Stiffness – carry over factor – distribution factor - Analysis of continuous beams – Analysis of portal frames with and without side sway (single storey and single bay). **Matrix Methods:** Structure Stiffness Matrix – Analysis of continuous beams – Analysis of portal frames without side sway (single storey and single bay) by matrix stiffness method – Analysis of continuous beams by matrix flexibility method.

Learning Resources

1. Wang, C.K., “ Indeterminate Structures” McGraw Hill Book Co., Newyork, 1994
2. Pandit G.S and Gupta S.P., “ Structural Analysis – A Matrix Approach” Tata McGraw-Hill Publishing Ltd. New Delhi, 2007.
3. Punmia, B.C., Arun Kumar, Ashok Kumar., Theory of structures, Laxmi Publications, New Delhi, 2014.
4. Devdas Menon., Structural Analysis, Alpha Science International, 2008.
5. Reddy, C.S., “Basic Structural Analysis”, Tata McGraw Hill Publishing Company Ltd., New Delhi, 2010
6. Junnarkar, S.B. & Shah, H.J., Mechanics of structures, vol.I, II, Charotar Publishing House, India, 2000
7. Thandavamoorthy, “Analysis of Structures”, Oxford & IBH Publishers, New Delhi. 2008
8. Jindal, R.L., “Indeterminate Structures”, S.Chand and Company Ltd., New Delhi 2000
9. NPTEL materials (<http://nptel.ac.in/courses/105106050>)

Course Contents and Lecture Schedule

Module No.	Topic	No. of Lectures	Course Outcome
1.0	ILD for indeterminate beams		
1.1	Muller Breslau’s Principle	1	CO1
1.2	Influence line diagram for propped cantilever	1	
1.3	Influence line diagram for continuous beams	2	
	Tutorial	2	

2.0	Strain Energy Method		
2.1	Castigliano's theorem of minimum strain energy	1	CO2
2.2	Analysis of continuous beams	1	
2.3	Analysis of frames	1	
	Tutorial	1	
2.4	Analysis of trusses	1	
	Tutorial	1	
3.0	Theorem of three moments		
3.1	Clapeyron's theorem of three moments	1	CO3
3.2	Analysis of continuous beams	2	
	Tutorial	2	
4.0	Slope Deflection Method		
4.1	Derivation of slope deflection equation	1	CO4
4.2	Analysis of continuous beams	2	
	Tutorial	2	
5.0	Moment Distribution Method		
5.1	Definition of stiffness, carry over factor and distribution factor	1	CO5
5.2	Analysis of continuous beams	2	
	Tutorial	1	
5.3	Analysis of portal frames without side sway	1	
5.4	Analysis of portal frames with side sway	1	
	Tutorial	1	
6.0	Matrix Methods		
6.1	Structure stiffness matrix	1	CO6
6.2	Analysis of continuous beams by matrix stiffness method	1	
6.3	Analysis of portal frames without side sway by matrix stiffness method	1	
	Tutorial	1	
6.4	Analysis of continuous beams by matrix flexibility method	2	
	Tutorial	1	
Total Hours (24 Hrs+12 Hrs)		36	

Course Designers:

1. Dr. D.Brindha dbciv@tce.edu
2. Mr.R.Sankaranarayanan rsciv@tce.edu

18CE430	HYDRAULICS AND HYDRAULIC MACHINERY	Category	L	T	P	Credit
		PC	2	1	0	3

Preamble

This course aims at an experimental way of studying the fluid flow, which deals with measurement, design and behavior of flow in open channels. Further, it also involves Dimensional analysis, model testing and design of hydraulic machines at an optimum cost.

Prerequisite

18CE330

Course Outcomes

On the successful completion of the course students will be able to

CO Number	Course Outcome Statement	Weightage*** in %
CO1	Explain the various types of open channels and their flows	14
CO2	Design the various types of most efficient channel sections	22
CO3	Apply the principles of Dimensional Analysis and Model Analysis in hydraulic engineering problems.	22
CO4	Compute the forces exerted by the jet of water on fixed and moving plates.	8
CO5	Design and study the performance of various types of hydraulic turbines.	16
CO6	Design and study the performance of various types of pumps.	16

*** Weightage depends on Bloom's Level, number of contact hours,

CO Mapping with CDIO Curriculum Framework

CO #	TCE Proficiency Scale	Learning Domain Level			CDIO Curricular Components (X.Y.Z)
		Cognitive	Affective	Psychomotor	
CO1	TPS2	Understand	Respond	Guided Response	1.1.1,1.1.2,1.2,
CO2	TPS3	Apply	Value	Mechanism	1.1.1,1.1.2,1.2.1.3,2.1.1,2.1.5.
CO3	TPS3	Apply	Value	Mechanism	1.1.1,1.1.2,1.2,2.1.1,2.1.5.
CO4	TPS3	Apply	Value	Mechanism	1.1.1,1.1.2,1.2. 2.1.1,2.1.5.
CO5	TPS3	Apply	Value	Mechanism	1.1.1,1.1.2,1.2.1.3, 2.1.1,2.1.5,
CO6	TPS3	Apply	Value	Mechanism	1.1.1,1.1.2,1.2.1.3, 2.1.1,2.1.5,

Mapping with Programme Outcomes and Programme Specific Outcomes

Cos	PO1	PO2	PO3	PO4	PO5	PO6	PO7	PO8	PO9	PO10	PO11	PO12	PSO1	PSO2
CO1	L	L	L	L	-	-	-	-	-	-	-	-	L	-
CO2	S	S	S	S	-	-	-	M	-	-	-	M	M	L
CO3	S	S	S	S	-	-	-	-	-	-	-	-	M	L
CO4	S	S	L	L	-	L	-	-	-	-	-	-	M	L
CO5	S	S	S	S	-	L	L	M	-	-	-	-	M	L
CO6	S	S	S	S	-	L	L	M	-	-	-	-	M	L

S- Strong; M-Medium; L-Low

Assessment Pattern: Cognitive Domain

Cognitive Levels	Continuous Assessment Tests			Assignment			Terminal Examination
	1	2	3	1	2	3	
Remember	20	20	20	-	-	-	20
Understand	20	20	20	-	-	-	20
Apply	60	60	60	100	100	100	60
Analyse							
Evaluate							
Create							

Assessment Pattern: Psychomotor

Psychomotor Skill	Assignment
Perception	-
Set	-
Guided Response	50
Mechanism	50
Complex Overt Responses	-
Adaptation	-
Origination	-

Sample Questions for Course Outcome Assessment****Course Outcome 1(CO1):**

1. What is an open channel flow?
2. Differentiate between steady and unsteady flow in a channel.
3. Why is a bed slope provided for an open channel?

Course Outcome 2(CO2):

1. A rectangular channel is 7m wide and 1.8m deep. If the bed of the channel is laid at a slope of 1 in 6000, calculate the velocity of flow and discharge. Use Chezy's equation and assume $C = 50$
2. Determine the dimensions of the most economical trapezoidal earth-lined channel to carry $15\text{m}^3/\text{s}$ at a slope of 1 in 2400. Apply Manning's equation and assume $n = 0.020$
3. The discharge of water through a rectangular channel of width 7m, is $16\text{m}^3/\text{s}$ when the depth of flow of water is 1.2m, Calculate (i) Specific energy of the flowing water, (ii) critical depth and critical velocity and (iii) value of minimum specific energy.

Course Outcome 3(CO3):

1. The frictional torque T of a disc of diameter D rotating at a speed N in a fluid of viscosity μ and density ρ in a turbulent flow is given by

$$T = D^5 N^2 \rho \phi \left[\frac{\mu}{D^2 N \rho} \right]$$
 Prove this by the method of dimension.
2. The discharge Q of a centrifugal pump depends upon the mass density of the fluid ρ , the speed of the pump N , the diameter of the impeller D , the manometric head H , viscosity of the fluid μ and acceleration due to gravity g . Obtain an expression for Q , using Buckingham's π theorem.
3. A 7.0 m high and 10 m long spillway discharges $90\text{ m}^3/\text{s}$ discharge under a head of 2m. If 1:10 scale model of this spillway is to be constructed, determine model dimensions, head over spillway model and the model discharge. If model experiences a force of 7200N, determine force on the prototype.

Course Outcome 4 (CO4):

1. Derive an expression for the force exerted by a jet of water on a fixed vertical plate in the direction of the jet.
2. A jet of water 50mm in a diameter, issues with a velocity of 10m/s and impinges on a stationary flat plate which destroys its forward motion. Calculate the force exerted by the jet on the plate and the work done.
3. A jet of water having velocity of 30m/s strikes a curved vane which is moving with a velocity of 15m/s. The jet makes an angle of 30° with the direction of motion of vane at inlet and leaves at an angle of 120° to the direction of motion at outlet. Draw the velocity triangles at inlet and outlet. Also calculate (i) vane angles at inlet and outlet (θ , Φ) and (ii) work done per second on the vane by the jet.

Course Outcome 5 (CO5):

1. Design a Pelton wheel for a head of 50m when running at 250 rpm. The Pelton wheel develops 90kW shaft power. The velocity of buckets =0.45 times the velocity of jet, overall efficiency is 85% and co-efficient velocity is 0.98
2. An inward radial flow reaction turbine works at 500rpm under a head of 100m. The diameter of turbine at inlet is 1.0m and flow area is 0.35m^2 . The angles made by absolute velocity and relative velocities at inlet are 15° and 60° respectively with the tangential velocity. Determine (i) Volume rate of flow, (ii) Power developed and (iii) Hydraulic efficiency of turbine.
3. A turbine is to operate under a head of 30m at 300 r.p.m. The discharge is $10\text{m}^3/\text{s}$. If the efficiency is 90% determine (i) Specific speed of the turbine, (ii) Power generated and (iii) type of the turbine.

Course Outcome 6 (CO6):

1. Define slip of a reciprocating pump, at what condition the negative slip occur.
2. A centrifugal pump having outer diameter equal to two times the inner diameter and running at 1000 rpm, works against a total head of 40m. The velocity of flow through the impeller is constant and equal to 2.5 m/s. The vanes are curved back at an angle of 40° at outlet. If the outer diameter of the impeller is 600mm and width at outlet is 50mm, determine (i) Discharge through the pump, (ii) Vane angle at inlet (θ), (ii) Work done by impeller on water per second and (iii) Manometric efficiency.
3. The cylinder bore diameter of a single acting reciprocating pump is 200mm and its stroke is 400mm. The pump runs at 50 rpm and lifts water through a height of 25m. The delivery pipe is 22m long and 100mm in diameter. Find the theoretical discharge and theoretical power required to run the pump. If the actual discharge is 4.2 litres/s. Find the percentage of slip. Also determine the acceleration head at the beginning and middle of the delivery stroke.

Concept Map

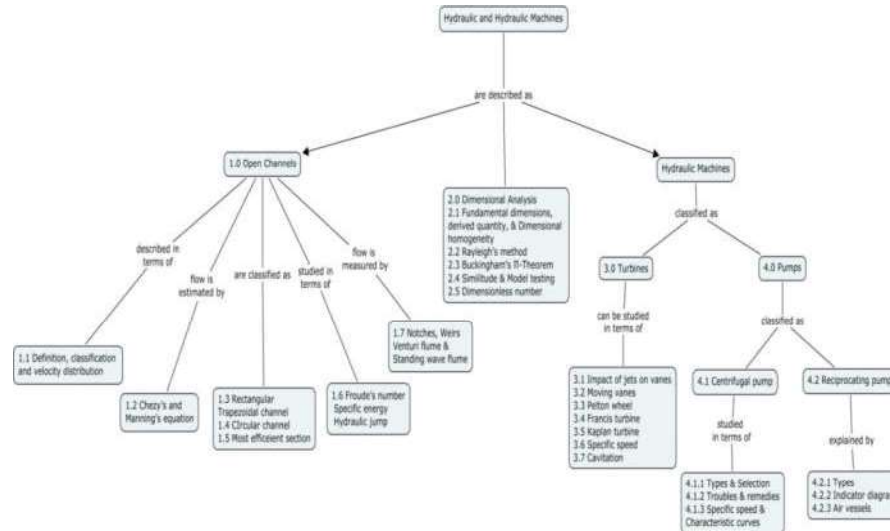

Syllabus

Open channel flow: Definition, classification, and velocity distribution in open channels. Chezy's and Manning's equation. Flow through rectangular, Trapezoidal and Circular channels. Hydraulically most efficient channel section. Froude's number, Specific energy diagram, Hydraulic jump, Notches and Weirs. **Dimensional Analysis:** Fundamental dimensions and derived quantity, Dimensional homogeneity, Rayleigh's method and Buckingham's π -Theorem, Similitude, Model testing, Dimensionless number. **Impact of jets:** Impact of jets on fixed and moving vanes. **Water turbines:** Classification, Pelton wheel, Francis turbine, Kaplan turbine, specific speed and Cavitation. **Pumps:** Types of pumps, Selection of pumps, Troubles and remedies, Multistage pumps, Characteristics curves, Specific speed. Single and double acting reciprocating pump, Multi-cylinder pump, Indicator diagram, Slip and Air vessels.

Learning Resources

1. Modi P.N and Seth S.M, "Hydraulics and Fluid Mechanics Including Hydraulic Machines" Standard Book House" New Delhi, 21st Edition 2017.
2. Bansal R.K, "Fluid Mechanics and Hydraulic Machines" Laxmi Publications, New Delhi, 10th Edition 2018.
3. Rajput. R.K, "A Text book of Fluid Mechanics and Hydraulic Machines", S.Chand and Company, New Delhi, 2011.
4. Subramanya K, "Flow in open channels", Tata McGraw-Hill Publishing Company, 2009.
5. Ramamrutham S and Narayanan R "Hydraulics, Fluid Mechanics and Fluid Machines", Dhanpat Rai Publishing Co (P) Ltd, New Delhi, 9th Edition 2014.

Course Contents and Lecture Schedule

Module No.	Topic	No. of Hours	Course Outcome
1	Open Channel Flow		
1.1	Introduction to open channel flow, Definition of open channel flow, uniform flow, steady flow, unsteady flow, GVF, RVF	1	CO1
1.2	Chezy's equation & Manning's equation,	1	
1.3	Problems on rectangular and trapezoidal channel section- Tutorial	2	
1.4	Circular channel section and Problems	1	
1.5	Definition for Most economical section, Most economical section	1	CO2

Module No.	Topic	No. of Hours	Course Outcome
	condition for rectangular section and Problems.		
1.6	Most economical section condition for trapezoidal section and Problems-Tutorial	2	
1.7	Most economical section condition for circular section	1	
1.8	Definition of Froude's number and Reynold's number , Definition of specific energy, specific energy diagram, critical depth, and critical velocity	1	
1.9	Expression for depth of hydraulic jump, & Expression for loss of energy due to hydraulic jump, Problems on hydraulic jumps	1	
1.10	Flow measurement by notches and weirs & problems	1	
1.11	Venturi flume and Standing wave flume & Problems	1	
2	Dimensional Analysis		
2.1	Introduction to dimensional analysis, fundamental dimensions, derived quantity, dimensional homogeneity and problems.	1	CO3
2.2	Rayleigh's method and problems	1	
2.3	Buckingham's Pi theorem and problems	2	
2.4	Similitude and model testing	1	
2.5	Dimensionless numbers and its application	1	
	Tutorial	2	
3	Impact of Jet		
3.1	Definition of impact of jet and stationary flat vanes	1	CO4
3.2	Problems on Stationary symmetrical & unsymmetrical curved vanes-Tutorial	2	
4	Hydraulic Turbines		
4.1	Introduction to water turbine and its classification, Pelton wheel & problems	1	CO5
4.2	Francis turbine working principle and problems	1	
4.3	Kaplan turbine working principle and problems	1	
4.4	Specific speed and cavitation in turbines	1	
	Tutorial	2	
5	Pumps		
5.1	Introduction to centrifugal pump, & Description of working principles, Troubles and remedies in centrifugal pumps	1	CO6
5.2	Performance characteristics, specific speed of centrifugal pumps, and selection of centrifugal pumps	1	
5.3	Introduction to reciprocating pump, single acting and double acting pump and slip	1	
5.4	Indicator diagrams, Air vessels and acceleration head and power required	1	
	Tutorial	2	
Total Hours (24 Hrs+12 Hrs)		36	

Course Designers:

- | | |
|------------------|---------------|
| 1. M.Ramasamy | mrciv@tce.edu |
| 2. Dr.T.Baskaran | tbciv@tce.edu |

18CE440	WASTEWATER ENGINEERING	Category	L	T	P	Credit
		PC	2	1	0	3

Preamble

This course work aims at imparting the basic knowledge on various stages of works involved in planning, designing and execution of underground drainage system for a town/ city. This involves characteristics study on wastewater, estimation of wastewater and storm drainage generation, collection of wastewater, evolving a suitable treatment system to bring down the pollution level to acceptable limit and disposal of the treated wastewater on to land/ water bodies without endangering the environment.

Course Outcomes

On the successful completion of the course students will be able to

CO Number	Course Outcome Statement	Weightage*** in %
CO1	Characterize the wastewater generated from a town/ city	10
CO2	Estimate the quantity of wastewater and storm run-off generated from the town/ city	15
CO3	Design a suitable collection system for the generated wastewater	15
CO4	Identify the sewer appurtenances needed for the smooth functioning of the sewerage and to perform the required maintenance operations involved in the system	15
CO5	Design the necessary treatment units for the wastewater collected from the town/city	25
CO6	Identify the suitable mode of disposal for the treated wastewater without endangering the environment.	20

*** Weightage depends on Bloom's Level, number of contact hours,

CO Mapping with CDIO Curriculum Framework

CO's	TCE Proficiency Scale	Learning Domain Level			CDIO Curricular Components (X.Y.Z)
		Cognitive	Affective	Psychomotor	
CO1	TPS2	Understand	Respond	Guided Response	1.1.1, 1.2.1.1, 3.1.1, 3.1.5, 3.2.5
CO2	TPS2	Understand	Respond	Guided Response	1.1.1, 1.2.1.1, 3.1.1, 3.1.5, 3.2.5
CO3	TPS3	Apply	Value	Mechanism	1.1.1, 1.1.2, 1.2.1.1, 3.1.1, 3.1.5, 3.2.5
CO4	TPS2	Understand	Respond	Guided Response	1.1.1, 1.2.1.1, 3.1.1, 3.1.5, 3.2.5
CO5	TPS3	Apply	Value	Mechanism	1.1.1, 1.1.2, 1.2.1.1, 3.1.1, 3.1.5, 3.2.5
CO6	TPS3	Apply	Value	Mechanism	1.1.1, 1.1.2, 1.2.1.1, 3.1.1, 3.1.5, 3.2.5

Mapping with Programme Outcomes and Programme Specific Outcomes

Cos	PO1	PO2	PO3	PO4	PO5	PO6	PO7	PO8	PO9	PO10	PO11	PO12	PSO1	PSO2
CO1	S	S	M	M	-	M	S	-	-	-	-	-	M	L
CO2	S	S	M	S	-	M	-	-	M	M	-	-	M	L
CO3	S	S	S	S	-	S	S	M	-	-	-	-	M	L
CO4	M	M	S	S	-	S	M	-	S	S	-	-	M	M

CO5	S	S	S	S	-	S	S	-	-	M	-	-	M	L
CO6	S	S	S	S	-	S	S	S	S	S	-	-	M	M

S- Strong; M-Medium; L-Low

Assessment Pattern: Cognitive Domain

Cognitive Levels	Continuous Assessment Tests			Assignment			Terminal Examination
	1	2	3	1	2	3	
Remember	20	20	20	-	-	-	20
Understand	40	30	30	25	25	25	30
Apply	40	50	50	75	75	75	50
Analyse	-	-	-	-	-	-	-
Evaluate	-	-	-	-	-	-	-
Create	-	-	-	-	-	-	-

Assessment Pattern: Psychomotor

Psychomotor Skill	Mini project / Assignment / Practical Component
Perception	-
Set	-
Guided Response	50
Mechanism	50
Complex Overt Responses	-
Adaptation	-
Origination	-

Sample Questions for Course Outcome Assessment**

Course Outcome1(CO1):

1. What is Population equivalent?
2. The 7 days 20°C BOD of a sample of sewage is 300mg/L and its 3days 20°C BOD is 210mg/L. find out the value of de-oxygenation constant k and then estimate its 5 days 30°C BOD.
3. The sewage discharge of a city is 85m³/s in the river having a minimum discharge of 930 l/s with a velocity of 0.12m/s. the BOD at 20°C of the sewage is 325mg/L. the BOD of the river is zero. Determine the quantity and point of critical DO deficit.

Course Outcome 2(CO2):

1. A district consists of 20% of area with runoff coefficient 0.9,20% of area with runoff coefficient 0.85,5% of area with 0.80,15% of area with 0.40 runoff coefficient, 35% of area with runoff coefficient 0.10 and remaining area with runoff efficient 0.05; determine the co-efficient of runoff for the area. If the total area of the district is 36 hectares and the maximum rain intensity is taken as 5cm/hr; what is the total runoff for the district? If the density of population is 250 per hectare and the rate of water supply is 200lit/day/capita. Calculate the quantity of sewage for which the sewer of a separate system is to be designed.
4. A 30cm diameter sewer having an invert slope of 1 in 150 was flowing full. What would be the velocity of flow and discharge? $N=0.013$. Is the velocity self-cleansing? What would be the velocity and discharge when the same is flowing at 0.20 and 0.80 of the full depth.
5. Suggest a suitable sewage collection system for a town with a population of 5.0 Lakhs. This town is very old with narrow lay- out of roads and streets.
6. With a help of a neat sketch, propose a wastewater collection system for a house with 2 bed rooms, 1 Hall, 1 sit-out, 1 kitchen etc.

Course Outcome3(CO3):

1. Discuss the role of velocity of flow in hydraulic design of sewers

- Justify the usage of various sewer appurtenances for the efficient performance of sewerage.
- Justify the usage of circular shaped sewers than other sections.
- Design a grit chamber system for a town with a population of 1.0 Lakh. Assume necessary design parameters appropriately.

Course Outcome 4 (CO4):

- Design a standard rate trickling filter for the following:
 Average incoming flow=350m³/hr
 BOD of primary effluent=210mg/L
 No of units=4
 Make suitable assumptions for any missing data.
- A sedimentation tank treating 4.5 million liters of sewage per day containing 275mg/L of suspended solids. The tank removes 50% suspended solids. Calculate the quantity of sludge produced per day in volume basis & weight basis, if (i) moisture content is 98% (ii) moisture content is 96%
- Why do we go for anaerobic treatment of sewage? Analyze the performance of different anaerobic treatment system?
- A city with a population of 2.0 Lakhs is to be provided with a secondary treatment facility. Suggest a treatment system and make a complete design.

Course Outcome 5 (CO5):

- Design a septic tank for the following data:
 No of people=100
 Sewage/capita/day=120L
 Desludging period=1yr
 L:B=4:1
- Design a septic tank unit for a housing colony with 100 persons. Also design the suitable effluent percolation unit.
- Suggest a disposal system for a town where the water scarcity is very high.

Course Outcome 6(CO6):

- Explain in detail about various methods of safe disposal of sewage.
- Describe discharge standards for the municipal wastewater either inland or in water bodies.

Concept Map

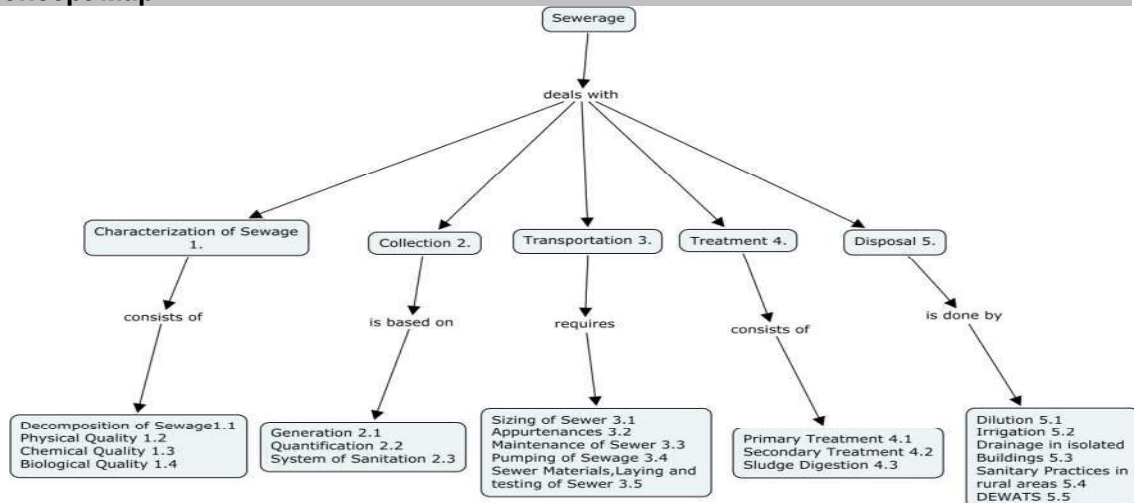

Syllabus

Characteristics of sewage - decomposition – aerobic and anaerobic decomposition, physical and chemical quality of sewage, BOD and their testing, BOD equation and problems, population equivalent. **Collection of Sewage** - Systems of sanitation, Estimating quantity of sewage, dry

weather flow, estimating storm run-off by rational formula. **Transportation of Wastewater** – Sewerage - separate, combined and partially separate system, hydraulic design of sewers, Sewer materials, laying and testing of sewer, sewer appurtenances, cleaning and ventilation of sewers, pumping of sewage. **Treatment of Wastewater** - Physico-chemical treatment of sewage, Biological treatment of sewage, aerobic treatment, activated sludge process and its mechanism, design parameters and design, modifications in ASP, Introduction to SBR and MBR, Trickling filters, process mechanism, types, design parameters and design, Hybrid system – MBBR (basics only), Natural systems, Ponds and Lagoons, Anaerobic systems – UASB, anaerobic filters and natural systems. **Impact of disposal of sewage** – Sludge characteristics, digestion tanks, design, disposal of digested sludge, Impact of disposal of treated sewage, Impact on river, self-purification, oxygen sag curve, streeter-phelps equation, Impact on lakes, Eutrophication, Impact on sea, Land irrigation, sewage farming, sewage sickness, Recycling of treated sewage, Disposal of sewage in isolated buildings, plumbing system – types; Sanitary practices in rural areas, ECOSAN, Water less urinals, Bio-toilets, Introduction to DEWATS.

Learning Resources

1. Garg S.K.: "Sewage Disposal and Air Pollution Engineering", Khanna Publishers New Delhi 2015.
2. Metcalf & Eddy : "Wastewater Engineering Treatment and Reuse" , Tata McGraw Hill Publishers, New Delhi, 2010.
3. Peavy, Rowe, Tchobanoglous, "Environmental Engineering", McGraw Hill Publishers, New Delhi, 2013.
4. Punmia B.C, Ashok Jain, "Wastewater Engineering", Laxmi publications, New Delhi, 1998.
5. Mark J.Hammer, Mark J.Hammer,Jr, "Water and Wastewater Technology", Prentice Hall of India Pvt.Ltd., New Delhi, 2011.
Manual on sewerage and sewage treatment, CPHEEO, Ministry of urban affairs & employment, Govt.of India, New Delhi, 2013.

Course Contents and Lecture Schedule

Module No.	Topic	No. of Lectures	Course Outcomes
1.0	Characterization of sewage		
1.1	Aerobic and anaerobic decomposition of sewage	1	CO1
1.2	Physical quality of sewage		CO1
1.3	Chemical quality of sewage		CO1
1.3.1	BOD , testing procedure and BOD equation	1	CO1
1.3.2	Problems in BOD and population equivalent – Tutorial	1	CO1
1.4	Biological quality of sewage	1	CO1
2.0	Collection of sewage		
2.1	Generation of sewage	1	CO2
2.2	Quantification of sewage- estimation		CO2
2.2.1	Estimation of storm runoff	1	CO2
2.3	System of sanitation	1	CO2
	Estimation of storm runoff – Tutorial	1	CO2
3.0	Transportation of wastewater		
3.1	Hydraulic design of sewer- principle	1	CO3
3.1.1	Problems in Hydraulic design of sewer –Tutorial	2	CO3
3.2	Sewer appurtenances	1	CO4
3.3	Maintenance of sewer	1	CO4
3.4	Pumping of sewage		CO4

Module No.	Topic	No. of Lectures	Course Outcomes
3.5	Sewer material, laying and testing of sewer		CO4
4.0	Treatment of wastewater		
4.1	Objectives of treatment – Physico - chemical treatment	1	CO5
4.2	Aerobic treatment – activated sludge process- process mechanism	1	CO5
4.2.1	Methods of aeration	1	CO5
4.2.2	Design consideration and design - Tutorial	2	CO5
4.2.3	Modification in ASP	1	CO5
4.2.4	Trickling filters- process mechanism, types		CO5
4.2.5	Design consideration – standard rate trickling filter	1	CO5
4.2.6	Design of standard rate trickling filter - Tutorial	1	CO5
4.2.7	High rate trickling filter- design – Tutorial	1	CO5
4.2.8	Hybrid system- SBR, MBR, MBBR	1	CO5
4.2.9	Natural systems – ponds and lagoons	1	CO5
4.3	Anaerobic system- UASB		CO5
4.3.1	Anaerobic filter, natural system	1	CO5
4.4	Sludge digestion- characteristics of sludge, digestion tanks	1	CO5
4.4.1	Design of digestion tank and disposal of digested sludge		CO5
	Sludge digestion tanks and Sludge Characteristics - Tutorial	1	CO5
5.0	Impact of disposal of sewage		
5.1	Impact of disposal of treated sewage – Impact on river	1	CO6
5.1.1	Self purification of streams		CO6
5.1.2	Oxygen sag curve for streams	1	CO6
5.1.3	Streeter helps equation- problems – Tutorial	2	CO6
5.1.4	Impact on lakes- eutrophication	1	CO6
5.1.5	Impact on sea		CO6
5.2	Land irrigation- sewage farming	1	CO6
5.2.1	Sewage sickness		CO6
5.3	Drainage system in isolated buildings- septic tanks – Tutorial	1	CO6
5.3.1	Plumbing system- types	1	CO6
5.3.2	Sanitary practices in rural areas, ECOSAN	1	CO6
5.4	Water less urinals, Bio-toilets, Introduction to DEWATS.		CO6
Total Hours (24 Hrs+12 Hrs)		36	

Course Designers:

1. Dr. T. VelRajan tvziv@tce.edu
2. Mrs.S. Sivasangari ssiciv@tce.edu
3. Ms.K.Keerthy kkciv@tce.edu

18EG460	PROFESSIONAL COMMUNICATION	Category	L	T	P	Credit
		HSS	0	1	2	2

Preamble

This course helps the students to achieve effective language proficiency for their professional, social and interpersonal communication skills, hence increasing their employability and career skills.

Prerequisite

Basic English Knowledge

Course Outcomes

On the successful completion of the course students will be able to

CO Number	Course Outcome Statement	Weightage*** in %
CO1	Listen, watch, understand and respond to talks, conversations, etc by native and neutral speakers on science, general context, and from ETS test samples with confidence.	22%
CO2	Present ideas, express opinions/comments, practice presentation, and converse in discussions on a variety of technical and non-technical domains without fear	39%
CO3	Read and comprehend passages/texts from various topics – general and reasoning, to respond precisely through reading techniques, besides getting awareness on competitive exam lexicon/verbal exercises for career prospects	17%
CO4	Write journal abstracts/projects and business correspondences with clarity, accuracy, intelligibility, and precision.	22%

*** Weightage depends on Bloom's Level, number of contact hours

CO Mapping with CDIO Curriculum Framework

CO #	TCE Proficiency Scale	Learning Domain Level			CDIO Curricular Components (X.Y.Z)
		Cognitive	Affective	Psychomotor	
CO1	TPS2	Understand	Respond	Guided Response	2.4.2, 2.4.6, 3.2.1, 3.2.2,
CO2	TPS3	Apply	Value	Mechanism	3.1.3, 3.1.2, 3.2.4, 3.2.5, 3.2.6
CO3	TPS2	Understand	Respond	Guided Response	2.4.6, 2.4.5, 3.2.1,
CO4	TPS3	Apply	Value	Mechanism	2.4.3, 3.2.1, 3.2.3, 3.2.5

Mapping with Programme Outcomes and Programme Specific Outcomes

Cos	PO1	PO2	PO3	PO4	PO5	PO6	PO7	PO8	PO9	PO10	PO11	PO12	PSO1	PSO2	PSO3
CO1									L	S		M			
CO2									S	S		M			
CO3									M	S		M			
CO4									M	S		M			

S- Strong; M-Medium; L-Low

Assessment Pattern:

Internal: No Continuous Assessment Test(CAT) will be conducted. Students' performance will be continuously assessed in various classroom activities in Listening, Speaking, Reading and Writing for 50 marks as detailed below:

Listening Test	- 10
Speaking Test (Group Discussion and Technical Presentation)	- 20
Written Test (Objective/Descriptive to be tested for 40 marks and converted to 20 marks)	- 20

External (Practical):

Group Discussion	- 20
Personal Interview / Situational Conversation (BEC speaking based)	- 20
Listening Test	- 20
Reading / Writing – Computerized or Paper-based Test/General Aptitude Test – Objective type	- 40

List of Experiments/Activities with CO Mapping

S.No	Activities	Hours		CO Mapping			
		T	P				
1	Listening, Reading and Writing based on Extensive Reading text	2		CO1		CO3	CO4
2	Listening exercises at lab - online resources		2	CO1			
3	Developing Listening skills (BEC / IELTS / TOEIC / TOEFL)		2	CO1			
4	GD/Mock interview/Presentation Intro at lab through online		2	CO1			
5	GD Practice at classroom in groups		4	CO1	CO2		
6	Presentation on Technical / general topics – from dailies &	1	4		CO2		
7	Mock interview practice at classroom	1	4	CO1	CO2		
8	Comprehension Descriptive and Reasoning	2	2			CO3	
9	General Aptitude Practice – Vocabulary Development / Sentence completion / Error spotting /Analogy / Reasoning	3	2			CO3	CO4
10	Business Correspondence - BEC Writing Task II	2					CO4
11	Basics of Technical Writing/ Project Reports		2		CO2		
12	Preparation of Resume	1					CO4

Learning Resources

Reference Books:

1. Cappel, Annette and Sharp, Wendy, Cambridge English: Objective First, 4th Ed., CUP, New Delhi, 2013.
2. Cusack, Barry. Improve Your IELTS Listening and Speaking Skills (With CD) Paperback, Mcmillan, 2007.
3. Bates, [Susan](#) TOEFL iBT Exam Paperback – Oxford, 2012.
4. Hart, Guy Brook. Cambridge English Business Benchmark: 2 Ed., CUP 2014

Websites:

1. <https://ielts-up.com> (IELTS – LSRW – Practice Tests)
2. www.cambridgeenglish.org (BEC - LSRW)
3. www.etsglobal.org (TOEIC Preparation)
4. www.examenglish.com (Online Exams for international ESL Exams)
5. www.testpreppractice.net (GRE Tests -Vocabulary /Analogy / Sentence Completion / Reading)
6. <https://www.freshersworld.com> (Placement Papers)

Extensive Reading:

Coelho, Paulo. The Alchemist, Harper Publication, 2018.

Course Designers:

1. Dr.A.Tamilselvi , Convenor
2. Dr S.Rajaram
3. Mr.Vinoth.R
4. Dr.G.Jeya Jeevakani
5. Ms.R.Manibala

18CE470	PROGRAMMING AND CODING LAB	Category	L	T	P	Credit
		ES	0	0	2	1

Preamble

The laboratory course is designed to enable the students to solve simple mathematical, numerical and engineering problems and provide solutions using C programming language. The list of experiments starts with implementation of fundamental concepts, various control structures, array handling methods, string manipulations, use of functions, structures and files in C programming language. Then, the concepts learnt are applied by taking case studies in the appropriate engineering domain. These experiments will strengthen the concepts learnt in the corresponding theory course.

Prerequisite

18CE350 : Programming for Problem solving

Course Outcomes

On the successful completion of the course, students will be able to

CO Number	Course Outcome Statement	Weightage in %
CO1	Demonstrate the working of fundamental algorithms using data types, constants and expressions in C language	10
CO2	Illustrate different control structures in C for solving the simple mathematical and engineering problems	10
CO3	Make use of array processing techniques to perform matrix manipulations.	15
CO4	Solve problems related to string manipulations, sorting and searching using functions or recursion as applicable	30
CO5	Write programs in C using files and structures to store, retrieve and process data	10
CO6	Experiment the case studies in civil engineering domain and solve using C programs	25

CO Mapping with CDIO Curriculum Framework

CO #	TCE Proficiency Scale	Learning Domain Level			CDIO Curricular Components (X.Y.Z)
		Cognitive	Affective	Psychomotor	
CO1	TPS3	Apply	Value	Mechanism	1.1, 2.1.1, 2.2.3
CO2	TPS3	Apply	Value	Mechanism	1.3, 2.1.1, 2.2.3
CO3	TPS3	Apply	Value	Mechanism	1.3, 2.1.1, 2.2.3
CO4	TPS3	Apply	Value	Mechanism	1.3, 2.1.1, 2.2.3
CO5	TPS3	Apply	Value	Mechanism	1.3, 2.1.1, 2.2.3
CO6	TPS3	Apply	Value	Mechanism	1.2, 2.1.1, 2.2.3

Mapping with Programme Outcomes and Programme Specific Outcomes

COs	PO1	PO2	PO3	PO4	PO5	PO6	PO7	PO8	PO9	PO10	PO11	PO12	PSO1	PSO2
CO1.	M	L	L		L									
CO2.	S	M	M		L				L			L		
CO3	S	M	M		L				L			L		

CO4	S	M	M		L				L			L		
CO5	S	M	M		L				L			L		
CO6	S	M	M	L	L	L			L	L	L	L		

Assessment Pattern: Cognitive Domain

Cognitive Levels	Model Examination	Terminal Examination
Remember		
Understand		
Apply	50	50
Analyse		
Evaluate		
Create		

Assessment Pattern: Psychomotor

Psychomotor Skill	Mini project / Practical Component / Observation
Perception	
Set	
Guided Response	
Mechanism	50
Complex Overt Responses	
Adaptation	
Origination	

List of Experiments/Activities with CO Mapping

Experiments	CO
Write C programs using fundamental algorithms <ul style="list-style-type: none"> Calculating simple Interest converting the temperature from Celsius to Fahrenheit Area and perimeter of rectangle 	CO1
Write C programs using selection and repetition control structures <ul style="list-style-type: none"> Simple Arithmetic Calculator Grade Computation Biggest of three numbers Sum of set of numbers Generating sine series 	CO2
Write C programs for array handling <ul style="list-style-type: none"> Maximum/ Minimum element in an array Read n number of values in an array and display it in reverse order Copy elements of one array to another array 	CO3
Write C programs for matrix manipulations <ul style="list-style-type: none"> Matrix Addition, Subtraction and Multiplication 	CO3
Write C programs using functions <ul style="list-style-type: none"> Swap of two numbers using call by value and call by reference Find GCD using function 	CO4
Develop C programs using recursion <ul style="list-style-type: none"> Fibonacci Series Factorial Computation 	CO4

Develop C programs for string manipulations <ul style="list-style-type: none">• Implement string operations such as string concatenation, copy, length	CO4
Write C programs to implement different sorting and sorting methods <ul style="list-style-type: none">• Linear Search• Bubble sort	CO4
Develop C programs using structures and files <ul style="list-style-type: none">• Storage, Retrieval and Processing of student data• Read and Write operations on text files	CO5
Implementation of any two case studies related to civil engineering using C programs	CO6

Course Designers:

1. Mrs.B.Subbulakshmi bscse@tce.edu
2. Dr.M.Vijayalakshmi mviji@tce.edu

18CE480	FLUID MECHANICS AND MACHINERY LAB	Category	L	T	P	Credit
		PC	0	0	2	1

Preamble

This laboratory is used in conjunction with Fluid Mechanics course in reinforcing the fundamentals of fluid mechanics and machinery by hands on experiment.

Prerequisite

18CE330

Course Outcomes

On the successful completion of the course students will be able to

CO Number	Course Outcome Statement	Weightage*** in %
CO1	Measure the rate of flow in pipe section as well as open channel sections.	33
CO2	Apply the Bernoulli's theorem in real world problems.	8
CO3	Calculate the major and minor losses in closed conduits	17
CO4	Explain the performance of hydraulic machines such as turbines and pumps.	42

*** Weightage depends on Bloom's Level, number of contact hours,

CO Mapping with CDIO Curriculum Framework

CO #	TCE Proficiency Scale	Learning Domain Level			CDIO Curricular Components (X.Y.Z)
		Cognitive	Affective	Psychomotor	
CO1	TPS2	Apply	Value	Mechanism	1.1.1, 1.1.2, 1.2, 2.1.5, 2.2.3, 3.2.5
CO2	TPS3	Apply	Value	Mechanism	1.1.1, 1.1.2, 1.2, 2.1.5, 2.2.3, 3.2.5
CO3	TPS3	Apply	Value	Mechanism	1.1.1, 1.1.2, 1.2, 2.1.5, 2.2.3, 3.2.5
CO4	TPS3	Apply	Value	Mechanism	1.1.1, 1.1.2, 1.2, 2.1.5, 2.2.3, 3.2.5

Mapping with Programme Outcomes and Programme Specific Outcomes

Cos	PO1	PO2	PO3	PO4	PO5	PO6	PO7	PO8	PO9	PO10	PO11	PO12	PSO1	PSO2
CO1	M	L	-	-	-	-	-	-	-	L	-	-	L	L
CO2	S	S	-	-	-	-	-	-	-	L	-	-	L	L
CO3	S	S	M	M	-	-	-	-	-	L	-	-	L	L
CO4	S	M	M	M	-	-	-	-	-	L	-	-	M	L

S- Strong; M-Medium; L-Low

Assessment Pattern: Cognitive Domain

Cognitive Levels	Model Examination	Terminal Examination
Remember	--	--
Understand	10	10
Apply	90	90
Analyse	--	--
Evaluate	--	--
Create	--	--

Assessment Pattern: Psychomotor

Psychomotor Skill	Mini-project /Practical Component/Observation
Perception	--
Set	--
Guided Response	50
Mechanism	50
Complex Overt Responses	--
Adaptation	--
Origination	--

List of Experiments/Activities with CO Mapping

S.No	Description	No of Hours	Course Outcome
1.	Determination of coefficient of discharge of Small Orifice	2	CO1
2.	Flow measurement in pipe using Orificemeter	2	
3.	Flow measurement in pipe using Venturimeter	2	
4.	Flow measurement in open channel using Notches	2	
5.	Verification of Bernoulli's theorem	2	CO2
6.	Determination of frictional loss in pipes	2	CO3
7.	Determination of minor losses in pipes	2	
8.	Study of impact of jet on vanes	2	CO4
9.	Performance test on turbines (Pelton wheel, Francis and Kaplan turbine)	4	
10.	Performance test on pumps (Centrifugal, Submersible and Reciprocating pump)	4	
Total Hours		24	

Course Designers:

1. Mr. M. Ramasamy mrciv@tce.edu
2. Dr. T. Baskaran tbciv@tce.edu

18CE490	PROJECT MANAGEMENT
----------------	---------------------------

Category	L	T	P	Credit
HSS	2	1	0	3

Preamble

This course gives an exposure to the basic concepts involved in the formulation of a project, project management principles, importance and need for network techniques and its applications to a project

Prerequisite

Nil

Course Outcomes

On the successful completion of the course students will be able to

CO Number	Course Outcome Statement	Weightage*** in %
CO1	Explain project, project management, life cycle and project formulation	10
CO2	Analyze and Manage time in projects through Gantt charts, CPM and PERT techniques, update and monitor projects	25
CO3	Manage resources of project using resource smoothing and levelling techniques	25
CO4	Optimize resources of projects using scheduling, fast tracking and re-estimation techniques with CPM Cost Model.	25
CO5	Identify the need for communication and risk management in projects with emerging trends in project management. Analyze Project worthiness using Earned Value Management	15

*** Weightage depends on Bloom's Level, number of contact hours,

CO Mapping with CDIO Curriculum Framework

CO #	TCE Proficiency Scale	Learning Domain Level			CDIO Curricular Components (X.Y.Z)
		Cognitive	Affective	Psychomotor	
CO1	TPS2	Understand	Respond	Guided Response	1.1, 3.1.1, 3.2.1, 3.3.1, 4.3.1
CO2	TPS 3	Apply	Value	Mechanism	1.1.1, 1.2, 2.1, 2.4.7, 4.3.4
CO3	TPS 3	Apply	Value	Mechanism	1.1.1, 2.1, 2.4.7, 4.3.4
CO4	TPS 3	Apply	Value	Mechanism	1.1.1, 2.1, 2.4.7, 4.3.4
CO5	TPS 3	Apply	Value	Mechanism	1.1.1, 2.1, 2.4.7, 4.3.4

Mapping with Programme Outcomes and Programme Specific Outcomes

Cos	PO1	PO2	PO3	PO4	PO5	PO6	PO7	PO8	PO9	PO10	PO11	PO12	PSO1	PSO2
CO1	-	-	L	L	-	-	L	L	L	L	-	S	-	M
CO2	S	S	-	M	L	-	M	-	L	M	L	S	M	-
CO3	S	S	-	M	-	-	M	S	L	M	M	S	L	-
CO4	S	S	-	M	-	-	L	S	L	M	M	S	L	-
CO5	-	L	L	L	L	L	M	L	S	M	M	S	M	L

S- Strong; M-Medium; L-Low

Assessment Pattern: Cognitive Domain

Cognitive Levels	Continuous Assessment Tests			Assignment			Terminal Examination
	1	2	3	1	2	3	
Remember	20	10	10	-	-	-	10
Understand	20	30	10	-	-	-	15
Apply	60	60	80	100	100	100	75
Analyse	-	-	-	-	-	-	-
Evaluate	-	-	-	-	-	-	-
Create	-	-	-	-	-	-	-

Assessment Pattern: Psychomotor

Psychomotor Skill	Assignment
Perception	-
Set	20
Guided Response	30
Mechanism	50
Complex Overt Responses	-
Adaptation	-
Origination	-

Sample Questions for Course Outcome Assessment**Course Outcome 1(CO1):**

1. Define project and project management. Mention its need
2. Discuss the functions of project management
3. Discuss the life cycle of projects with influencing factors

Course Outcome 2(CO2):

1. Differentiate between CPM and PERT
2. A project consists of six activities with the following logical relationships. Draw a network for the project and determine the critical path using traditional method
 - A and B are initial activities and can be performed concurrently
 - C follows A but cannot start until B is over
 - D and E succeed B
 - C and D precede F
 - E and F are terminal activities

Activity	A	B	C	D	E	F
Duration (Days)	7	8	3	2	7	4

3. Find the status of the project on the 10th day of its commencement.

Conduct Event oriented network analysis for the following project and determine:

- Earliest and latest allowable occurrence times for the events
- Expected time and standard deviations for activities
- Project completion time and its degree of variability
- What is the probability of completing the project 2 days ahead of schedule?
- What is the probability of not completing the project 1 day behind schedule?
- Find the due date that has 75% chance of being met?

Activity (i-j)	1-2	1-3	2-4	3-4	3-5	4-5	5-6
t_0 days	2	3	4	0	7	2	4
t_m days	3	3	10	0	12	7	6
t_p days	5	3	12	0	15	9	8

Course Outcome 3 (CO3):

1. Prepare the need for balancing of resources in project? Mention its significance

- For an automobile industry project you as a project manager are vested with the responsibility of balancing manpower requirement, which method would you adopt for this process. Justify your answer with suitable reasons.
- Balance the resource demand for the following project so as to meet the availability of only 7 men/day

Activity (i-j)	0-1	0-3	0-6	1-2	3-4	3-7	6-7	2-5	4-5	7-8	5-8
Duration (days)	2	2	1	4	5	8	3	1	4	5	3
Manpower	3	6	4	2	2	4	5	4	2	2	5

Course Outcome 4 (CO4):

- Define the term direct cost in projects with examples
- Prepare the need and meaning of fast tracking and estimation of projects
- A project consists of 7 activities with costs and times gives as shown in table. Crash the project and determine the optimum time and minimum cost relationship for the project. Assume the indirect cost to vary at Rs.500/- per day.

Activity (i-j)	1-2	1-3	2-4	3-4	3-5	4-5	5-6
Normal time days	5	7	4	2	5	3	4
Crash time days	3	4	2	1	3	2	1
Normal cost Rs.	500	100	200	400	350	380	50
Crash cost Rs.	800	300	500	750	800	900	150

Course Outcome 5(CO5):

- Conduct EVA for a project having a Budget at Completion as Rs. 100 lakhs and estimated duration of completion as 5 years. The status of the project by the end of 2.5 years is as follows: PV = Rs. 60 lakhs, EV = Rs. 52.5 lakhs and CV = Rs. 70 lakhs. Determine CV, SV, CPI, SPI, EAC, ETC, Final Cost, Final Schedule and TCPI for the project
- Discuss why effective communication is needed for the success of any projects taking an example
- Take of project of your choice in a mechanical industry and list and discuss the risks in the project along with possible methods of its mitigation.

Concept Map

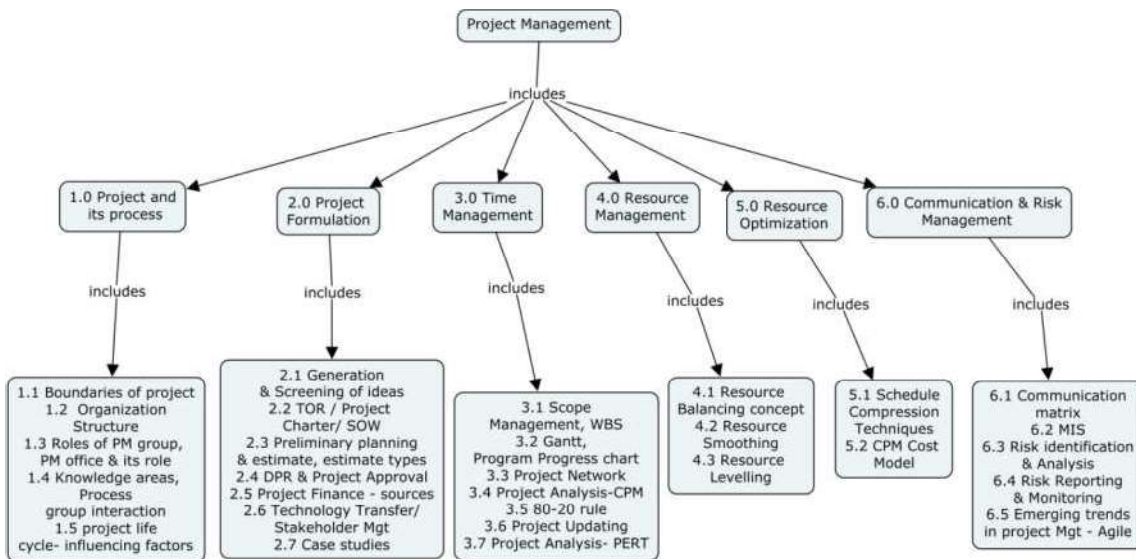

Syllabus

Project and its process- Define project and process, Objectives and functions of Project management, organization structure / styles, roles of project management group, project integration, project life cycle- influencing factors. - Case study. **Project Formulation:** Generation and Screening of PM ideas- Triple Constraint, TOR/ Project Charter/ SOW - Creation of project Charter. Preliminary planning and Types of estimate. Project Presentation & Approval – Detailed Project Report & Approval, Project finance. Technology transfer- PPP Concepts, Stakeholder Management -Case study. **Time Management:** Project Scope Management - Work break down structure. Project planning tools- Project Network- Fulkerson's rules – Activity-On-Arrow and Activity-On-Node networks. Analyze project time- Critical path method - 80-20 rule- Square network diagram. Introduction to project management software. Project updating and monitoring- Case study**. Estimate time- Program Evaluation & Review Technique. **Resource Management:** Types of resource- Balancing of resource- Resource Smoothing technique- Resource leveling technique- - Case study. **Resource optimization:** Types of cost – Variation of Cost with time. Schedule Compression Techniques- Crash time and crash cost. Optimize project cost. CPM Cost model. **Communication Management:** Communication Management-communication matrix Case study, Management information system, Guidelines of meeting- Case study. **Risk Management:** Risk management – meaning and process. Risk identification and analysis techniques- FMEA and SWOT analysis, Risk reporting and monitoring- Case study. **Emerging trends in project management :** Introduction to Theory of Constraints, Earned Value Management Agile Project management - Case study.

Learning Resources

1. Punmia B. C. and Khandelwal K.K., "Project Planning and Control with PERT/CPM", Laxmi publications, New Delhi, 1989.
2. "A Guide to the Project Management Body of Knowledge (PMBOK Guide)" - Fifth Edition, An American National Standard, ANSI/PMI 990001-2008.
3. Jerome D. Wiest and Ferdinand K. Levy, "A Management Guide to PERT/CPM", Prentice Hall of India Publishers Ltd., New Delhi, 1994.
4. Srinath L.S., "PERT & CPM- Principles and Applications", Affiliated East West Press Pvt., Ltd., New Delhi, 2008
5. A Risk Management Standard, AIRMIC Publishers, ALARM, IRM: 2002
6. Gene Dixon, "Service Learning and Integrated Collaborative Project Management", Project Management Journal, DOI:10.1002/pmi, February 2011, pp.42-58
7. Nptel videos at <https://nptel.ac.in/courses/105106149/> by Dr. Koshy Varghese, Dept of Civil Engineering, IIT, Madras.

Course Contents and Lecture Schedule

Module No.	Topic	No. of Lectures	COs
1.0 Project and its process			
1.1	Define project and process, boundaries of project	1	CO1
1.2	Objectives and functions of Project management, characteristics of projects, Organization structure / styles of project		
1.3	Roles of project management group, project management office and its role	1	
1.4	Project knowledge area, project integration- process group interaction		
1.5	Project flow, project life cycle- influencing factors, Case study	1	

2.0 Project Formulation			
2.1	Generation and Screening of PM ideas, Triple Constraint – Time, Cost and Scope	1	CO1
2.2	TOR/ Project Charter/ SOW (Statement of Work)- Creation of project Charter		
2.3	Preliminary planning and estimate- Types of estimate- Ball park, Parametric and Bottom up estimates	1	
2.4	Project Presentation and Approval- Detailed Project Report and Approval (Technical and Budget Sanction)		
2.5	Project Finance - sources		
2.6	Technology Transfer – PPP (BOT, BOLT, BOOT), Stakeholder Management	1	
2.7	Case study		
3.0 Time Management			
3.1	Project Scope Management, Work break down structure - Activity/ Task- Events- Case study. Project planning tools- Rolling wave planning-Tutorial	2	CO2
3.2	Gantt Charts, Milestone chart, Program Progress chart- Creating milestone plan		
3.3	Project Network- Fulkerson's rules – A-O-A and A-O-N networks Introduction to software-Tutorial	2	
3.4	Analyze project time- Critical path method (deterministic approach- activity oriented network analysis- Square network diagram-Tutorial	2	
3.5	80-20 rule, type of time estimates - Case study	1	
3.6	Project updating and monitoring- Case study	2	
3.7	Estimate time- PERT (Probabilistic Approach)- Event oriented network analysis- Optimistic, Pessimistic & Most likely time, Degree of variability in average time, Probabilistic estimate, % utilization of resources- Tutorial	2	
	Tutorial	2	
4.0 Resource Management			
4.1	Types of resource- Time, Men, Material, Machinery, Money, Space. Balancing of resource- need and purpose- Case study	2	CO3
4.2	Resource Smoothing technique- Time constraint-Tutorial	2	
4.3	Resource levelling technique- Resource constraint	2	
	Tutorial	2	
5.0 Resource optimization			
5.1	Types of cost – Direct, Indirect and Total Cost. Variation of Cost with time. Schedule Compression Techniques- Crashing, Fast Tracking & Re-estimation Crash time and crash cost- Tutorials	2	CO4
5.2	Optimize project cost for time and resource- CPM Cost model- Case study	2	
	Tutorials	2	
6.0 Communication & Risk Management			
6.1	Communication Management- meaning and process, communication matrix		
6.2	Management information system, Guidelines of meeting- Case study	1	
6.3	Risk management – meaning and process. Risk	1	

18CE510	CONCRETE TECHNOLOGY				
	Category	L	T	P	Credit
	PC	3	0	0	3

Preamble

Concrete Technology focuses more on detailed understanding of concrete making materials and production process. Recent developments in concrete materials are also given adequate consideration. Going through the course, student would develop adequate understanding on concrete production process and properties and uses of concrete as a modern material of construction. The course will also enable the student to make appropriate decision regarding ingredient selection and use of concrete.

Course Outcomes

On the successful completion of the course students will be able to

CO Number	Course Outcome Statement	Weightage*** in %
CO1	Explain the properties and tests of various constituents present in concrete	25
CO2	Demonstrate various manufacturing process of concrete and properties and workability tests of fresh concrete	15
CO3	Design concrete mix as per IS and ACI standards	15
CO4	Enumerate the mechanical behaviour and properties of hardened concrete	15
CO5	Demonstrate the long term properties of concrete and identify the solutions for field problems	15
CO6	Select the suitable type of special concrete for real time situations	15

*** Weightage depends on Bloom's Level, number of contact hours,

CO Mapping with CDIO Curriculum Framework

CO #	TCE Proficiency Scale	Learning Domain Level			CDIO Curricular Components (X.Y.Z)
		Cognitive	Affective	Psychomotor	
CO1	TPS2	Understand	Respond	Mechanism	1.1.1,2.1.1,4.3.4,4.4.4
CO2	TPS3	Apply	Valuing	Mechanism	1.1.1,1.2.2,1.3.2,1.3.3,2.1.2,2.1.5,2.4.4,2.4.6,3.2.5,4.1.1,4.3.3,4.5.4
CO3	TPS3	Apply	Valuing	Mechanism	1.1.1,1.2.2,1.3.2,1.3.3,2.1.2,2.1.5,2.4.4,2.4.6,3.2.5,4.1.1,4.3.3,4.5.4
CO4	TPS3	Apply	Valuing	Mechanism	1.1.1,1.2.2,1.3.2,1.3.3,2.1.2,2.1.5,2.4.4,2.4.6,3.2.5,4.1.1,4.3.3,4.5.4
CO5	TPS3	Apply	Valuing	Mechanism	1.1.1,1.2.2,1.3.2,1.3.3,2.1.2,2.1.5,2.4.4,2.4.6,3.2.5,4.1.1,4.3.3,4.5.4
CO6	TPS3	Apply	Valuing	Mechanism	1.1.1,1.2.2,2.1.1,2.4.4,3.2.5,4.1.1

Mapping with Programme Outcomes and Programme Specific Outcomes

Cos	PO1	PO2	PO3	PO4	PO5	PO6	PO7	PO8	PO9	PO10	PO11	PO12	PSO1	PSO2
CO1	M	L	-	-	-	-	L	-	M	L	L	-	-	L

CO2	S	M	L	-	-	-	L	L	M	L	L	L	-	L
CO3	S	M	L	M	-	-	-	-	L	-	L	-	L	L
CO4	S	M	L	-	-	-	-	-	L	-	L	-	-	L
CO5	S	M	L	-	-	-	-	L	M	L	M	M	L	L
CO6	S	M	L	M	L	L	L	L	M	M	M	M	L	L

S- Strong; M-Medium; L-Low

Assessment Pattern: Cognitive Domain

Cognitive Levels	Continuous Assessment Tests			Assignment			Terminal Examination
	1	2	3	1	2	3	
Remember	20	20	20	-	-	-	20
Understand	60	20	20	-	-	-	20
Apply	20	60	60	100	100	100	60
Analyse							
Evaluate							
Create							

Assessment Pattern: Psychomotor

Psychomotor Skill	Miniproject /Assignment/Practical Component
Perception	-
Set	-
Guided Response	50
Mechanism	50
Complex Overt Responses	-
Adaptation	-
Origination	-

Course Level Assessment Questions

Course Outcome 1 (CO1):

1. Differentiate admixtures and additives.
2. Define specific gravity and bulk density.
3. Explain the process of hydration of cement.

Course Outcome 2 (CO2):

1. Explain the various factors influencing the workability of concrete.
2. Suggest suitable type of compaction for
 - Placing of beams and columns
 - Road construction work
 - Precast slab construction
3. Suggest suitable type of curing for the following structural components
 - Roof slab
 - Masonry walls
 - Pre-stressed concrete sleepers

Course Outcome 3 (CO3):

1. Arrive suitable concrete mix for M40 concrete for the following concrete.
 - i. Characteristic strength on concrete at 28 days : 40N/mm²
 - ii. Ordinary Portland Cement of 53 grade
 - iii. Degree of Workability : 75 – 100 mm slump
 - iv. Degree of Exposure : Mild
 - v. Maximum size of Aggregate : 20 mm

- vi. Specific Gravity of Coarse Aggregate : 2.75
- vii. Specific Gravity of Coarse Aggregate : 2.63
- viii. Specific Gravity of Cement : 3.05
- ix. Degree of Quality control : Good.

2. Design a suitable concrete mix with the following particulars using IS 10262-1982.

- x. Characteristic strength on concrete at 28 days : 20N/mm^2
- xi. Ordinary Portland Cement of 53 grade
- xii. Degree of Workability : 50-75 mm slump
- xiii. Degree of Exposure : Mild
- xiv. Maximum size of Aggregate : 20 mm
- xv. Specific Gravity of Coarse Aggregate : 2.7
- xvi. Specific Gravity of Coarse Aggregate : 2.6
- xvii. Specific Gravity of Cement : 3.15
- xviii. Degree of Quality control : Good.

3. Construct the step by step procedure of concrete mix design as per ACI method

Course Outcome 4 (CO4):

1. Suggest suitable solutions to the following problems in concrete and RCC members and justify it.
 - Freezing and thawing effect on concrete
 - Shrinkage in concrete
 - Acid attack in concrete
2. Construct the procedure to determine the tensile strength of concrete.
3. Discuss the various types of non destructive testing methods.

Course Outcome 5 (CO5):

1. Select suitable type of protective measures may apply on rebars against corrosion.
2. A RCC structure is to be constructed in a marine environment. Discuss the various preventive measures you would recommend to make the structure safe against corrosion of rebars.
3. How to overcome the following effects on structures?
 - i. Corrosion effect on steel rods.
 - ii. Resistance to chloride and sulphate reactions.
 - iii. Alkali aggregate reaction.

Course Outcome 6 (CO6):

1. Choose the suitable special concrete that can be used for the following situations and explain briefly.
 - a. To reduce the self weight of the structure.
 - b. To enhance the tensile strength of concrete.
 - c. Shuttering and formwork is not possible.
2. Differentiate light weight and heavy weight concrete.
3. Choose the suitable type of concrete for congested reinforced area.

Concept Map

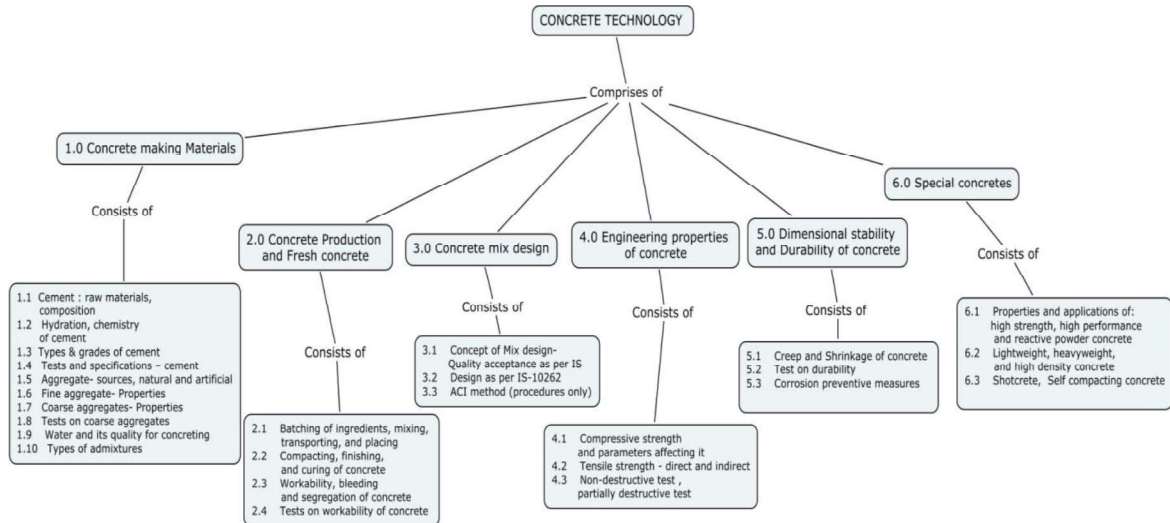

Syllabus

Concrete making Materials:

Cement: Raw materials; composition - Hydration, chemistry of cement ; Types, Tests and specifications- Consistency, setting time, soundness and fineness test. **Aggregates:**Source-natural and artificial.**Fine aggregates:**River sand & MSand :physical properties-Gradation, fineness modulus, specific gravity, bulk density, bulking of sand, water absorption, moisture content,presence of deleterious content.**Coarse aggregates:** Size and shape, gradation, fineness modulus, specific gravity, bulk density sieve analysis, water absorption. Tests on coarse aggregates- impact, crushing, abrasion and attrition, alkali aggregate reaction. **Water:** Qualities of water for concreting- tolerable concentrations of impurities, sea water and its effects. **Concrete Production & Fresh concrete:** Batching of ingredients; mixing, transporting, and placing - Compacting, finishing, and curing of concrete - Workability, bleeding and segregation of concrete - Factors influencing it - Tests on workability of concrete.**Admixtures:**Types of Admixtures- super plasticisers, plasticisers, retarders, accelerators, air entrained admixtures and pozzolanic admixtures**Concrete mix design:** Concept of Mix design-Quality acceptance criteria as per Indian standard method. Design of concrete mixes as per IS-10262, ACI method (procedure only). **Engineering properties of concrete:** Compressive strength and parameters affecting it - Tensile strength - direct and indirect; Modulus of elasticity and Poisson's ratio, flexural strength of concrete- Non-destructive test , partially destructive test.**Dimensional stability and Durability of concrete:** Creep - parameters affecting - Shrinkage of concrete - types and its significance; Introduction to durability; relation between durability and permeability - Chemical attacks on concrete- sulphate attack, chloride, acid attacks, sea water attacks, carbonation attacks - Corrosion of steel rebars, corrosion preventive measures. **Special concretes:** Properties and applications of: high strength, high performance and reactive powder concrete - Lightweight, heavyweight, and high density concrete, Concrete, Self compacting concrete and Geo polymer concrete.

Text Book

1. Shetty M.S., "Concrete Technology", 7th edition, S.Chand and company Limited, 2012.
2. Neville A.M., "Properties of concrete", 5th edition, Pearson India, 2012.

Reference Books

1. Mehta, P.K., "Concrete: Microstructure, Properties and Materials " 4th edition, Tata McGraw Hill Education Private Limited, 2013
2. Gambhir, "Concrete Technology", 5th edition, McGraw Hill Education (India) Private Limited, 2013.
3. Santha Kumar A.R., "Concrete Technology", Oxford University Press, New Delhi, 2009.
4. www.nptel.ac.in

IS Codes

1. IS: 10262-2009, Recommended guidelines for Concrete Mix Design.
2. IS: 456 - 2000, Plain and Reinforced concrete – code of practice
3. SP: 23-1982, Handbook on concrete.
4. ACI Committee 211.1- 91, standard practice for selecting proportions for normal, heavy weight and mass concrete, Part I, ACI manual of concrete practice, 1994.

Course Contents and Lecture Schedule

Module No.	Topic	No. of Lectures
1.0	Concrete making Materials	
1.1	Cement : raw materials, composition	1
1.2	Hydration, chemistry of cement	1
1.3	Types & grades of cement	1
1.4	Tests and specifications – consistency, setting time, soundness test, fineness test, chemical analysis	2
1.5	Aggregate- sources, natural and artificial	1
1.6	Fine aggregate- bulking of sand, presence of deleterious content, water absorption and moisture content- River sand & MSand.	1
1.7	Coarse aggregates – size and shape, gradation, fineness modulus, specific gravity, bulk density sieve analysis, water absorption.	1
1.8	Tests on coarse aggregates- impact, crushing, abrasion and attrition, alkali aggregate reaction	2
1.9	Water and its quality for concreting	1
2.0	Manufacturing process of concrete	
2.1	Batching of ingredients, mixing, transporting, and placing	2
2.2	Compacting, finishing, and curing of concrete	2
2.3	Fresh concrete: Workability, bleeding and segregation of concrete - Factors influencing it	1
2.4	Tests on workability of concrete	1
2.5	Admixtures: Super plasticisers, plasticisers, retarders, accelerators, air entrained admixtures and	1
2.6	Pozzolanic admixtures	1
3.0	Concrete mix design	
3.1	Concept of Mix design-Quality acceptance criteria as per IS	1
3.2	Design as per IS-10262	2
3.3	Design problems	1
3.4	ACI method (procedures only)	1
4.0	Engineering properties of concrete	
4.1	Compressive strength and parameters affecting it	1
4.2	Tensile strength - direct and indirect; Modulus of elasticity and Poisson's ratio, flexural strength of concrete	2
4.3	Non-destructive test , partially destructive test	1

Module No.	Topic	No. of Lectures
5.0	Dimensional stability and Durability of concrete	
5.1	Creep and Shrinkage of concrete	1
5.2	Test on durability – Chemical attacks of concrete, Corrosion of steel rebars	2
5.3	Corrosion preventive measures	1
6.0	Special concretes	
6.1	Properties and applications of: high strength, high performance and Reactive powder concrete	2
6.2	Lightweight concrete, High density concrete	1
6.3	Shotcrete, Self compacting concrete, Geo-polymer concrete	1
Total hours		36

Course Designers:

1. Dr.D.Brindha dbciv@tce.edu

18CE520	SOIL MECHANICS				
	Category	L	T	P	Credit
	PC	3	0	0	3

Preamble

This course deals with the application of laws of Mechanics and Hydraulics to solve engineering problems related with soils like flow of water through soil, Shear strength, Compressibility & Compaction characteristics of soil, Stress distribution in soil and analyzing the stability of earthen slopes.

Prerequisite

18CE230 - Engineering Mechanics

Course Outcomes

On the successful completion of the course students will be able to

CO Number	Course Outcome Statement	Weightage*** in %
CO1	Identify various types of soil, classify them and compute their index properties.	20
CO2	Understand the flow of water through soil medium and calculate the permeability of cohesive and cohesionless soils.	15
CO3	Calculate effective stress within soils and compute stresses in soil due to external loads.	15
CO4	Compute the shear strength of soils based on the parameters obtained from shear tests.	20
CO5	Understand the concept of consolidation and estimate the settlement of soil due to consolidation.	15
CO6	Illustrate the significance of soil compaction and analyse stability of earth slopes	15

*** Weightage depends on Bloom's Level, number of contact hours,

CO Mapping with CDIO Curriculum Framework

CO #	TCE Proficiency Scale	Learning Domain Level			CDIO Curricular Components (X.Y.Z)
		Cognitive	Affective	Psychomotor	
CO1	TPS3	Apply	Value	Mechanism	1.1.1,1.1.2,1.2,2.1.1,2.1.3,2.1.5
CO2	TPS3	Apply	Value	Mechanism	1.1.1,1.1.2,1.2,2.1.1,2.1.3,2.1.5, 2.4.4
CO3	TPS3	Apply	Value	Mechanism	1.1.1,1.1.2,1.2,2.1.1,2.1.3,2.1.5
CO4	TPS3	Apply	Value	Mechanism	1.1.1,1.1.2,1.2,2.1.1,2.1.3,2.1.5, 2.4.4
CO5	TPS3	Apply	Value	Mechanism	1.1.1,1.1.2,1.2,2.1.1,2.1.3,2.1.5
CO6	TPS3	Apply	Value	Mechanism	1.1.1,1.1.2,1.2,2.1.1,2.1.3,2.1.5,2.4.2, 2.4.6

Mapping with Programme Outcomes and Programme Specific Outcomes

Cos	PO1	PO2	PO3	PO4	PO5	PO6	PO7	PO8	PO9	PO10	PO11	PO12	PSO1	PSO2
CO	S	M	L	-	-	-	-	L	-	-	-	L	M	-

1														
CO 2	S	M	L	-	-	L	-	M	-	-	-	M	M	L
CO 3	S	M	L	-	-	-	-	M	-	-	-	M	M	L
CO 4	S	M	L	-	-	-	-	M	-	-	-	M	M	L
CO 5	S	M	L	-	-	L	-	M	-	-	-	M	M	L
CO 6	S	M	L	-	-	M	M	M	L	L	-	M	M	L

S- Strong; M-Medium; L-Low

Assessment Pattern: Cognitive Domain

Cognitive Levels	Continuous Assessment Tests			Assignment			Terminal Examination
	1	2	3	1	2	3	
Remember	10	10	10	-	-	-	10
Understand	10	10	10	-	-	-	10
Apply	80	80	80	100	100	100	80
Analyse							
Evaluate							
Create							

Assessment Pattern: Psychomotor

Psychomotor Skill	Miniproject/Assignment/Practical Component
Perception	-
Set	-
Guided Response	60
Mechanism	40
Complex Overt Responses	-
Adaptation	-
Origination	-

Sample Questions for Course Outcome Assessment**

Course Outcome1(CO1):

- Distinguish between Index and Engineering properties.
- The following data relate to 5 fine grained soil samples.

L.L (%)	25	45	50	60	80
P.L (%)	15	23	25	35	36
- A soil in the borrow pit is at a dry density of 16.5 kN/m^3 with a moisture content of 9%. The soil is excavated from this pit and compacted in an embankment to a dry density of 18 kN/m^3 with a moisture content of 13%. Compute the quantity of soil to be excavated from the borrow pit and the amount of water to be added for 100 m^3 of compacted soil in the embankment.

Course Outcome2(CO2):

- List out the factors affecting permeability of soil.
- A constant head permeability test was carried out on a cylindrical sample of sand 10cm diameter and 15cm height. 200 cc of water is collected in 2 mins under a head of 30cm. Compute the coefficient of permeability in m/year. Also calculate the discharge velocity and seepage velocity if void ratio of the sample is 0.75.

3. There is a three layered soil deposit. The thickness of the second layer is twice the thickness of the first and the thickness of the third layer is thrice the thickness of the first. The permeability of the second layer is twice the permeability of the first and the permeability of the third layer is half the permeability of the first. Compute the ratio of average permeability of the deposit in horizontal direction to that in the vertical direction.

Course Outcome3(CO3):

1. Explain Quick sand condition in soil.
2. Water table is lowered from a depth of 3m to a depth of 6m in a deposit of silt. The silt deposit has a water content of 20%. Its degree of saturation above water table is 65%. Estimate the increase in effective stress at a depth of 10m due to lowering of the water table. Assume $G=2.7$.
3. A square footing 2m x 2m resting on the surface of a soil exerts a pressure of 150kN/m². Determine the stress at a point which is at a depth of 5m below the centre of the footing using Boussinesq's theory.

Course Outcome 4 (CO4):

1. Explain Mohr-Coulomb failure criterion.
2. Consolidated Undrained triaxial tests are performed on two identical specimens of saturated, remoulded clay with pore pressure measurements. The observations are recorded in the table below

Test No.	Cell pressure at failure (kN/m ²)	Deviator stress at failure (kN/m ²)	Pore pressure at failure (kN/m ²)
1.	250	179	101
2.	350	242	145

Determine the values of the shear strength parameters in terms of total and effective stresses. If in the consolidated undrained test, an identical specimen is first consolidated under a cell pressure of 400 kN/m², what would be the deviator stress at failure?

3. Borings at a site show the following subsurface condition:

<u>Depths</u>	<u>Material</u>	<u>Properties</u>
0 to 2m	Silt	$\rho = 1.44 \text{ gm/cc}$
2m to 12m	Sand	$\rho_{\text{sat}} = 1.9 \text{ gm/cc}$
12m to 18m	clay	$\rho_{\text{sat}} = 1.78 \text{ gm/cc},$ $C = 20 \text{ kN/m}^2, \phi = 18^\circ$

Ground water table is at a depth of 2m below the ground surface. Estimate the shear strength along a plane at a depth of 16m below the ground surface.

Course Outcome 5 (CO5):

1. Explain the procedure for determining Coefficient of Consolidation by \sqrt{t} method.
2. A 3m thick clay layer beneath a building is overlain by a permeable stratum and is underlain by an impervious rock. The coefficient of consolidation of the clay was found to be 0.028cm²/min. The final expected settlement for the layer is 8cm.
 - i) How much time will it take for 60% of total settlement to take place?
 - ii) Determine the time required for a settlement of 3.5cm.
 - iii) What will be the settlement in 8 months?
3. In an Oedometer test 2 cm thick sample of clay reached 40% consolidation in 5minutes. What will be the time required for a clay layer 4m thick in field to reach the same degree of

consolidation? Sample and the clay layer in field have same drainage conditions (double drainage).

Course Outcome 6(CO6):

1. Calculate the compaction energy in Light and Heavy compaction tests.
2. Following are the results of Standard Proctor Compaction test performed on a soil sample:

Water Content (%)	5	10	14	20	25
Bulk density (g/c.c)	1.77	1.98	2.1	2.18	2.16

Plot the water content – dry density curve and obtain the optimum moisture content and maximum dry density. Calculate the water content necessary to completely saturate the sample at its maximum dry density, assuming no change in the volume. Take $G = 2.7$.

3. An embankment is inclined at an angle of 35° and its height is 12m. The angle of shearing resistance is 17° and the cohesion is 200kN/m^2 . The unit weight of the soil is 18 kN/m^3 . If the Taylor's stability number is 0.06, find the factor of safety with respect to cohesion.

Concept Map

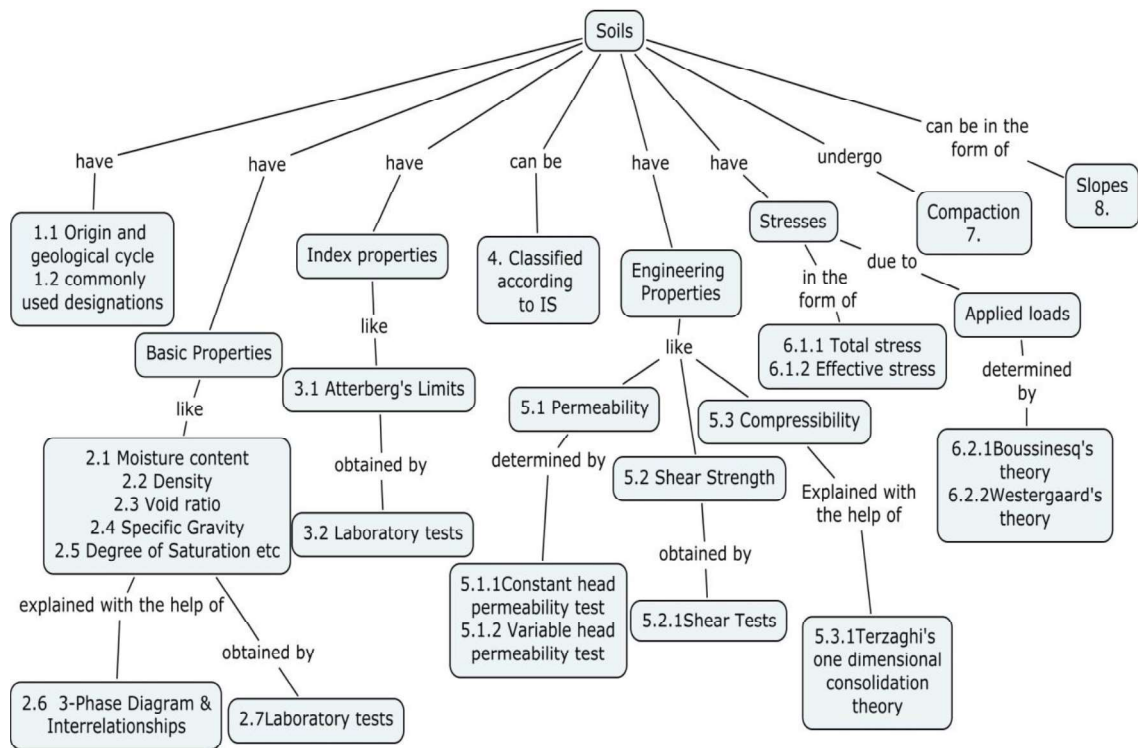

Syllabus

Origin and Properties of soils: Formation of soil - Commonly used soil designations -Phase relationships – Index Properties - Laboratory tests – Particle size distribution analysis - Determination of consistency limits and their significance to the field behaviour of soil - BIS Soil classification system. **Permeability:** Darcy's law and its validity - Determination of permeability in laboratory - Factors affecting permeability - Seepage analysis – Laplace's equation – Introduction to Flow nets. **Geostatic Stress and Stress distribution in soil:** Concept of total and effective stress in saturated soils deposits - Quick sand condition – Stresses due to external

loads - Boussinesq's theory (Point load, UDL and Line Load) - Concept of pressure bulb - Approximate methods – Use of Newmark's influence chart. **Shear Strength:** Shear strength of cohesive and cohesionless soils - Mohr-Coulomb failure criterion - Classification of shear test based on drainage conditions - Direct shear test - Unconfined compression test – Triaxial compression test - Vane shear test - Liquefaction. **Compressibility:** Concept of consolidation - Terzaghi's theory of one dimensional consolidation – Components of settlement - Computation of rate of settlement – Determination of C_v by \sqrt{t} method and log time method - Calculation of consolidation settlement – Precompression with sand drains. **Soil Compaction:** Concept of compaction – Standard proctor and Modified proctor compaction Tests – Factors affecting compaction – Field compaction methods and machineries. **Stability of Slopes:** Types of slope failures – Different factors of safety – Stability analysis of Infinite and finite slopes – Taylor's stability number – Stability analysis by method of slices and " $\phi_u=0$ " analysis – Slope stabilization methods

Learning Resources

1. Braja M. Das, "Fundamentals of Geotechnical Engineering", Fourth Edition, Cengage Learning, New Delhi, 2014.
2. Murthy, V.N.S, "Soil Mechanics and Foundation Engineering", CBS Publishers Distribution Ltd., New Delhi, 2015.
3. GopalRanjan and Rao, A.S.R., "Basic and Applied Soil Mechanics", New Age International (P) Limited, Publishers New Delhi (India), 2013.
4. Dr. Arora, K. R., "Soil Mechanics and Foundation Engineering", Standard Publishers Distributors, New Delhi, 2015.
5. Robert D. Holtz, William D. Kovacs, Thomas C. Sheahan, "An Introduction to Geotechnical Engineering", Indian Edition, Dorling Kindersley India Pvt. Ltd., Noida, 2017.
6. NPTEL Material <https://nptel.ac.in/courses/105103097/>

Course Contents and Lecture Schedule

Module No.	Topic	No. Of Hours	Course Outcome
1.	Origin and Properties of soils		
1.1	Formation of soil – Commonly used soil designations	1	CO1
1.2	Phase relationships–Index properties	1	
1.3	Laboratory tests	1	
1.4	Particle size distribution analysis	2	
1.5	Determination of consistency limits and their significance to the field behaviour of soil	2	
1.6	BIS soil classification system	2	
2.	Permeability		
2.1	Darcy's law and its validity – Determination of permeability in laboratory	2	CO2
2.2	Factors affecting permeability – Seepage analysis – Laplace's equation	2	
2.3	Introduction to Flow Nets	1	
3.	Geostatic Stress and Stress distribution in soil		
3.1	Concept of total and effective stress in saturated soils deposits – Quick sand condition	2	CO3
3.2	Stresses due to external loads – Boussinesq's theory (Point load, UDL and Line Load)	2	
3.3	Concept of Pressure bulb – Approximate methods – Use of Newmark's influence chart	1	
4.	Shear Strength		
4.1	Shear strength of cohesive and cohesionless soils –	2	CO4

	Mohr-Coulomb failure criterion – Classification of shear test based on drainage conditions		
4.2	Direct shear test – Unconfined compression test	2	
4.3	Triaxial compression test – Vane shear test – Liquefaction	2	
5.	Compressibility		
5.1	Concept of consolidation – Terzaghi's theory of one dimensional consolidation	1	CO5
5.2	Components of settlement – Computation of rate of settlement	1	
5.3	Determination of C_v by \sqrt{t} method and log time method – Calculation of consolidation settlement	2	
5.4	Precompression with sand drains	1	
6.	Soil Compaction		
6.1	Concept of compaction - Standard proctor and Modified proctor compaction Tests	2	CO6
6.2	Factors affecting compaction - Field compaction methods and machineries	2	
7.	Stability of Slopes		
7.1	Types of slope failures - Different factors of safety - Stability analysis of infinite and finite slopes	2	CO6
7.2	Taylor's stability number - Stability analysis by method of slices and " $\phi_u=0$ " analysis	1	
7.3	Slope stabilization methods	1	
	Total Hours	36	

Course Designers:

1. Dr. R. Sanjay Kumar

sanjaykumar@tce.edu

18CE530	ACCOUNTING AND FINANCE
----------------	-------------------------------

Category	L	T	P	Credit
HSS	3	-	-	3

Preamble

Engineering profession involves lots of decision making. The decisions may range from operation to non-operation. For taking decisions of these kinds, an engineer needs among other data about the organization routine operations and non-routine operations. Accounting is a science which provides all the data by recording, classifying, summarizing and interpreting the various transactions taking place in an organization and thereby helps an engineer in taking vital decisions in an effective manner. Finance is an allied but a separate field relying on accounting and enables engineers in taking useful financial and cost related decisions by providing well defined concepts, tools and techniques

Prerequisite

Nil

Course Outcomes

On the successful completion of the course students will be able to

CO Number	Course Outcome Statement	Weightage*** in %
CO1	Prepare financial statements of accounting and study them with common size statements and comparative statements.	20
CO2	Perform cost sheet, depreciation and its applications in business.	15
CO3	Compute various types of budgets in an organization	15
CO4	Practice break even analysis and activity based costing systems for a business applications..	15
CO5	Compute working capital requirements and long term investment decisions.	20
CO6	Apply the appropriate sources of finance and mobilize the right quantum of finance and use them in most profitable investment avenues	15

*** Weightage depends on Bloom's Level, number of contact hours,

CO Mapping with CDIO Curriculum Framework

CO #	TCE Proficiency Scale	Learning Domain Level			CDIO Curricular Components (X.Y.Z)
		Cognitive	Affective	Psychomotor	
CO1	TPS3	Apply	Value	Mechanism	1.1, 1.2, 2.1,3.2, 4.1.1, 4.1.2, 4.4.5, 4.6.5
CO2	TPS3	Apply	Value	Mechanism	1.1, 1.2, 2.1,3.2, 4.1.1, 4.1.2, 4.4.5, 4.6.5
CO3	TPS3	Apply	Value	Mechanism	1.1, 1.2, 2.1,3.2, 4.1.1, 4.1.2, 4.4.5, 4.6.5
CO4	TPS3	Apply	Value	Mechanism	1.1, 1.2, 2.1,3.2, 4.1.1, 4.1.2, 4.4.5, 4.6.5
CO5	TPS3	Apply	Value	Mechanism	1.1, 1.2, 2.1,3.2, 4.1.1, 4.1.2, 4.4.5, 4.6.5
CO6	TPS3	Apply	Value	Mechanism	1.1, 1.2, 2.1,3.2, 4.1.1, 4.1.2, 4.4.5, 4.6.5

Mapping with Programme Outcomes and Programme Specific Outcomes

Cos	PO1	PO2	PO 3	PO 4	PO 5	PO 6	PO 7	PO 8	PO 9	PO10	PO11	PO12	PSO1	PSO2
CO1	M	M	L	-	-	M	S	M	S	S	S	S	M	M
CO2	S	M	L	-	-	-	M	M	S	S	S	M	M	M
CO3	S	M	L	-	-	-	-	S	S	S	S	S	M	M
CO4	M	M	L	-	M	M	L	S	S	S	S	M	-	S
CO5	M	M	L	-	S	M	M	S	S	S	M	M	-	-
CO6	L	M	L	-	-	M	M	S	M	M	M	S	M	M

S- Strong; M-Medium; L-Low

Assessment Pattern: Cognitive Domain

Cognitive Levels	Continuous Assessment Tests			Assignment			Terminal Examination
	1	2	3	1	2	3	
Remember	20	20	20	-	-	-	20
Understand	30	30	30	-	-	-	20
Apply	50	50	50	100	100	100 (Case study)	60
Analyse	-	-	-	-	-	-	-
Evaluate	-	-	-	-	-	-	-
Create	-	-	-	-	-	-	-

Assessment Pattern: Psychomotor

Psychomotor Skill	Mini project/Assignment/Practical Component
Perception	
Set	
Guided Response	
Mechanism	Assignment
Complex Overt Responses	
Adaptation	
Origination	

Sample Questions for Course Outcome Assessment**

** (2 to 3 at the cognitive level of course outcome)

Course Outcome 1(CO1):

1. Prepare Trading Account, Profit and Loss Account and Balance Sheet from the following

S.NO	PARTICULARS	Debit balances (in Rs)	Credit balances(in Rs)
1	Capital		300000
2	Bank	15000	
3	Plant and machinery	40000	
4	Land and building	60000	
5	Debtors	20000	
6	Creditors		40000
7	Cash	70000	
8	Purchases and sales	35000	50000
9	Purchase returns and sales returns	7000	4000
10	Bills receivable	3000	
11	Bills payable		5000

12	Wages	40000	
13	Salaries	30000	
14	Discount		4000
15	Stock on Jan 2017	10000	
16	Furniture	7000	
17	Carriage inwards	5000	
18	Carriage outwards	6000	
19	Advertising	10000	
20	Travelling expense	3000	
21	Loans		60000
22	Vans	100000	
23	Telephone	2000	
	Total	463000	463000

2. From the following particulars, prepare comparative balance sheet of Malar Ltd as on 31st March 2017 and 31st March 2018.

Particulars	31 st March 2017	31 st March 2018
I EQUITY AND LIABILITIES		
1. Shareholders' fund		
a) Share capital		
b) Reserves and surplus	2,00,000	2,50,000
2. Non-current liabilities	50,000	50,000
Long-term borrowings		
3. Current liabilities	30,000	60,000
Trade payables		
	20,000	60,000
Total	3,00,000	4,20,000
II ASSETS		
1. Non-current assets		
a) Fixed assets	1,00,000	1,50,000
b) Non-current investments	50,000	75,000
2. Current assets		
a) Inventories	75,000	1,50,000
b) Cash and cash equivalents	75,000	45,000
Total	3,00,000	4,20,000

Course Outcome 2(CO2):

1. Classify the cost according to function.
2. Prepare cost sheet in the book of Vimi from the following particulars.

Opening stock: -	Raw material	=	Rs 5,000
	Finished goods	=	Rs 4,000
Closing stock:	Raw material	=	Rs 4,000
	Finished goods	=	Rs 5,000

Raw material purchased	=	Rs 50,000
Wages paid to laboures	=	Rs 20,000
Chargeable expenses	=	Rs 2,000
Rent and Taxes	=	Rs 7,400
Power	=	Rs 3,000
Experimental expenses	=	Rs 600
Sale of wastage of material	=	Rs 200
Office management salary	=	Rs 4,000
Office printing & stationery	=	Rs 200
Salaries to salesman	=	Rs 2,000
Commission to traveling agents	=	Rs 1,000

Sales = Rs 1, 00,000

Course Outcome 3(CO3):

1. Explain the advantages and applications of budgetary control.
2. From the forecast of income and expenditure prepare a cash budget for the months from April to June 2019.

Month	Sales Rs	Purchases Rs	Wages Rs	Office expenses Rs	Selling expenses Rs
Feb	70,000	45,000	4,500	2,700	1,800
Mar	72,000	43,000	4,700	3,000	2,000
Apr	75,000	44,000	4,900	2,900	2,200
May	71,000	40,000	5,000	3,000	2,100
Jun	70,000	42,000	5,000	2,800	1,900

o Plant
worth
Rs25,

000 purchased in June. 40% payable immediately and the remaining in two equal instalments in subsequent months.

- o Advance tax payable in April Rs 4500
- o Period of credit allowed
 - By suppliers 2 months
 - To customer 1 month
- o Dividend payable Rs 7000 in June
- o Delay in payment of wages and office expenses 1 month and selling expenses 1 month. Expected cash balance on 1st April Rs 30,000

Machinery expected to sell on May is Rs 20,000

Course Outcome 4 (CO4):

1. From the following information calculate the Breakeven point in terms of units and breakeven point in terms of sales. Sales....Rs.10,000, Variable costs Rs.6,000, fixed costs Rs.2000:profit Rs.2,000;No. Of units produced 1,000 units.
2. Calculate the breakeven point and margin of safety from the following information Fixed cost .Rs.10,000, sales in Rs.25,000, selling price per unit Rs.30; variable cost per unit Rs.10.

Course Outcome 5(CO5):

1. From the following information extracted from the books of a manufacturing company, compute the operating cycle in days and the amount of working capital required:

Period Covered	365 days
Average period of credit allowed by suppliers	16 days
Average Total of Debtors Outstanding	480
Raw Material Consumption	4,400
Total Production Cost	10,000
Total Cost of Sales	10,500
Sales for the year	16,000

Value of Average Stock maintained:

Raw Material	320
Work-in-progress	350

Finished Goods

260

2. From the following data of a project, Calculate IRR and suggest whether the project is to be undertaken or not if the cut off rate is 9%.

Cash Out flow (Rs.)		1,50,000
Cash Inflow(Rs.)	Year 1	41,000
	Year 2	50,000
	Year 3	50,000
	Year 4	42,000

Course Outcome 6(CO6):

- Analyse the sources of finance to start small scale business.
- Suggest suitable sources of finance to start a business with a capital of 60 crores.

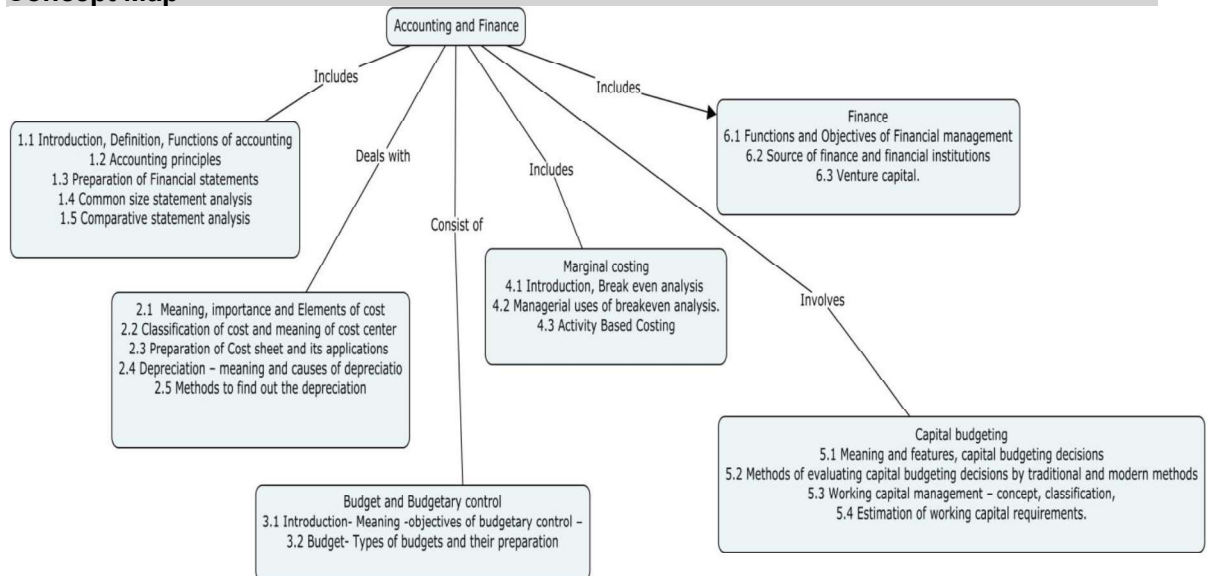
Concept Map**Syllabus**

Accounting Introduction definition, functions of accounting, accounting principles. Preparation of financial statements and study them with common size and comparative statements. **Cost Accounting** - Meaning and importance -Elements of cost- classification of cost- Cost centre, Preparation of cost sheet and its applications .Depreciation – meaning and causes of depreciation, Methods to find out the depreciation **Budget and Budgetary control**- Introduction- Meaning -objectives of budgetary control –Budget-Types of budgets and their preparation. **Marginal costing**- Introduction, Break even analysis –Managerial of breakeven analysis. Activity based Costing. **Capital budgeting**- Meaning and features, capital budgeting decisions, Methods of evaluating capital budgeting decisions by traditional and modern methods. Working capital management - concept, classification, Estimation of working capital requirements. **Finance**: Functions, Objectives of financial management and Source of finance and financial institutions, Venture capital. **Case Studies**: Cost management in the construction industry. (Only for assignment)

Learning Resources

- M.C.Shukla, T.S.Grewal, "Advanced Accounts-Volume-I, 2010 Reprint, S. Chand & company Ltd., 2010.
- Prasanna Chandra, "Financial Management-Theory and practice" seventh Reprint, Tata McGraw-Hill publishing company Limited, 2010.

3. P.S.BoopathiManickam "Financial and Management Accounting" PSG publications 2009.
4. Don R. Hansen and Maryanne M. Mowen "Cost Management: Accounting and Control, Fifth Edition" Thomson, 2006.
5. Michael C . Ehrhardt and Eugene F . Brigham, "Financial Management: Theory and Practice -thirteenth edition" South-Western cengage learning, 2011
6. Pandey, "Financial Management", Vikas Publishing House Pvt. Ltd., 2007
7. Paramasivan.C, Subramanian.T, "Financial management" New Age international Publishers, 2014.
8. <https://nptel.ac.in/courses/110/106/110106135/>: Decision making using financial accounting, Prof. G Arun Kumar, IIT Madras
9. <https://nptel.ac.in/courses/110/101/110101131/> : Financial Accounting, Dr. Varadraj Bapat, IIT Bombay.
10. <https://nptel.ac.in/courses/110/107/110107127/>: Management Accounting, Prof. Anil K. Sharma, IIT Roorkee.
11. <https://nptel.ac.in/courses/105104178/>: Introduction to Accounting and Finance for Civil Engineers, Dr. Sudhir Misra, IIT Kanpur.
12. <https://www.youtube.com/watch?v=P9JIBbZas3w>: Introduction to accounting, Dr.S.Vaidhyasubramanian, Adjunct professor, Sastra University.

Course Contents and Lecture Schedule

Module No	Topic	No. of Lectures	Cos
1	Accounting		
1.1	Introduction, Definition, Functions of accounting	1	CO1
1.2	Accounting principles	1	
1.3	Preparation of Financial statements	3	
1.4	Common size statement analysis	1	
1.5	Comparative statement analysis	1	
2	Cost Accounting		
2.1	Meaning, importance and Elements of cost	1	CO2
2.2	classification of cost and meaning of Cost centre,	1	
2.3	Preparation of Cost sheet and its applications	3	
2.4	Depreciation – meaning and causes of depreciation	1	
2.5	Methods to find out the depreciation	2	
3	Budget and Budgetary control		
3.1	Introduction- Meaning -objectives of budgetary control –	1	CO3
3.2	Budget- Types of budgets and their preparation	4	
4	Marginal costing		
4.1	Introduction, Break even analysis	2	CO4
4.2	Managerial uses of breakeven analysis.	1	
4.3	Activity Based Costing	2	
5	Capital budgeting		
5.1	Meaning and features, capital budgeting decisions	1	CO5
5.2	Methods of evaluating capital budgeting decisions by traditional and modern methods	4	
5.3	Working capital management – concept, classification,	1	
5.4	Estimation of working capital requirements.	1	
6	Finance		

6.1	Function sand Objectives of Financial management	1	CO6
6.2	Source of finance and financial institutions	3	
6.3	Venture capital.	1	
	Total	36 hrs	

Course Designers:

1. Mr.B.Brucelee bbmech@tce.edu
2. Dr.R.Sivasankaran rssmech@tce.edu
3. Mr.S.Rajkumar srmech@tce.edu

18CE560	DESIGN OF STEEL ELEMENTS	Category	L	T	P	Credit
		PC	3	-	-	3

Preamble

The primary concern of an engineer is design. Structural design consists conceptualization, idealization, analysis, design, construction and maintenance. Conceptualization is required to arrive at the final shape and size of the structure. Idealization involves reducing the conceived structure into primary elements. By analysis internal forces like bending moments, shear, torsion, compression and tension in each and every element is determined. Design assigns every element a particular material and size. Construction involves putting all the elements together to perform like the originally conceived structure. Maintenance is needed to keep the performance of the structure without deterioration. In this course, the exposure to code provisions, Plastic analysis and designs of structural elements, like beam, walls and columns, made of steel are dealt with. Further the elements are designed for internal forces like tension, compression, bending moment and shear.

Prerequisite

18CE220-Engineering Mechanics, 18CE320-Mechanics of Solids

Course Outcomes

On the successful completion of the course students will be able to

CO Number	Course Outcome Statement	Weightage*** in %
CO1	Demonstrate the force transferring mechanism, apply the principles in designing and detailing the bolted connections	30
CO2	Illustrate the force transferring mechanism and apply the principle in designing and detailing the welded connections	10
CO3	Apply the code provisions in estimating the capacity, and dimensioning the member with detailing of the steel tension members.	15
CO4	Compute the capacity and arrive compression members' cross section along with the suitable column base.	20
CO5	Execute the plastic analysis of indeterminate beams and portal frames to predicting collapse load factor / plastic Moment capacity.	10
CO6	Apply the code provisions for the strength and stability assessment of flexure members with or without lateral support	15

*** Weightage depends on Bloom's Level, number of contact hours.

CO Mapping with CDIO Curriculum Framework

CO #	TCE Proficiency Scale	Learning Domain Level			CDIO Curricular Components (X.Y.Z)
		Cognitive	Affective	Psychomotor	
CO1	TPS2	Apply	Value	Mechanism	1.1.1, 2.1.1, 4.4.1,3.2.5 , 4.4.2, 4.4.3,
CO2	TPS3	Apply	Value	Mechanism	1.1.1, 2.1.1, 4.4.1,3.2.5 , 4.4.2, 4.4.3,
CO3	TPS3	Apply	Value	Mechanism	1.1.1, 2.1.1, 4.4.1,3.2.5 , 4.4.2, 4.4.3,

CO4	TPS3	Apply	Value	Mechanism	1.1.1, 2.1.1, 4.4.1,3.2.5 , 4.4.2, 4.4.3,
CO5	TPS3	Apply	Value	Mechanism	1.1.1, 2.1.1, 4.4.1,3.2.5 , 4.4.2, 4.4.3,
CO6	TPS3	Apply	Value	Mechanism	1.1.1, 2.1.1, 4.4.1,3.2.5 , 4.4.2, 4.4.3,

Mapping with Programme Outcomes and Programme Specific Outcomes

Cos	PO1	PO2	PO3	PO4	PO5 K3	PO6 K3	PO7 K2	PO8 K3	PO9 K5	PO10 K6	PO11 K3	PO12 K2	PSO1 K5	PSO2 K5
CO1	S	M	L		M	M	S	M	-	-	M	S	M	M
CO2	S	M	L	-	S	S	S	S	L	-	S	S	M	M
CO3	S	M	L	-	S	S	S	S	L	-	S	S	M	M
CO4	S	M	L	-	S	S	S	S	L	-	S	S	M	L
CO5	S	M	L	-	S	S	S	S	L	-	S	S	M	L
CO6	S	M	L	-	S	S	S	S	L	-	S	S	M	L

S- Strong; M-Medium; L-Low

Assessment Pattern: Cognitive Domain

Cognitive Levels	Continuous Assessment Tests			Assignment			Terminal Examination
	1	2	3	1	2	3	
Remember	-	-	-	-	-	-	-
Understand	40	40	40	50	50	50	40
Apply	60	60	60	50	50	50	60
Analyse	-	-	-	-	-	-	-
Evaluate	-	-	-	-	-	-	-
Create	-	-	-	-	-	-	-

Assessment Pattern: Psychomotor

Psychomotor Skill	Mini project /Assignment/Practical Component
Perception	-
Set	-
Guided Response	50
Mechanism	50
Complex Overt Responses	-
Adaptation	-
Origination	-

Sample Questions for Course Outcome Assessment**

** (2 to 3 at the cognitive level of course outcome)

Course Outcome 1(CO1):

1. Design rolled steel I- sections for a simply supported beam with a clear span of 6m .it carries a UDL of 50 KN per metre exclusive of self-weight of the girder The beam is laterally unsupported.
2. Calculate the maximum span of ISMB600 beam which can be used to carry a uniformly distributed load excluding its self weight equal to its bending capacity. The beam can be considered as laterally supported.
3. A simply supported beam of span 10m subjected to two point loads each of magnitude 45kN at 2.5m from the simply supports. Design the beam according to strength criteria if the compression flange is laterally supported at mid span

Course Outcome 2(CO2):

1. A bolted shell is made up of 14mm thick plates. The joint is double bolted lap joint with M22 bolt of grade 4.6 at a pitch of 75mm. Determine in what way the joint will fail? Also calculate the efficiency of the joint.
2. Find the value of P, if M20 bolts of grade 4.6 are to be used in the bracket connection as shown in Figure 1. Consider the pitch and edge distance as 60 mm. Use Fe410 grade plates.

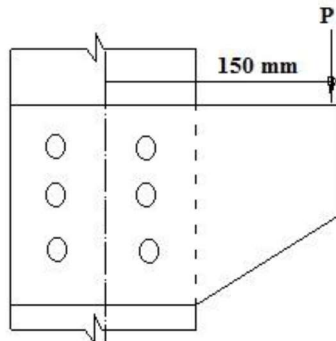

3. Design a lap joint between two plates of size 100 x 18mm and 100 x 12mm thick so as to transmit a factored load of 120kN using M20 bolts of grade 4.6 and grade Fe410. Also determine the efficiency of the joint.

Course Outcome 3(CO3):

1. How to calculate the effective throat thickness of fillet and groove weld, explain with the help of a neat sketch?
2. An ISMC 300 is used to transmit a factored force of 850kN. The channel section is connected to a gusset plate 10mm thick. Determine a suitable fillet weld length for the connection, if the overlap is limited to 310mm. Use slot weld if required. Assume the thickness of weld as 8mm.
3. A bracket plate is welded to the flange of a column as shown below. Calculate the size of the weld required to support a factored load of 100kN.

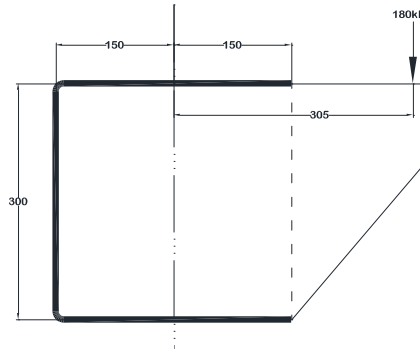

Course Outcome 4 (CO4):

1. A single unequal angle section ISA 100 x 75 x 10 mm is connected to a 12 mm thick gusset plate at the ends with 6 Nos. of M16 bolts of grade 4.6 are arranged in a single row. Determine the design tensile strength of the angle section if 100 mm leg is connected to the

gusset plate. Consider the pitch and edge distance as 60 mm and 40 mm respectively. Use Fe410 plates.

- Design a single angle tension member carrying a load 200 kN. The length of the member is 4 m. The member is connected to 6 mm thick gusset plate with M20 Gr.8.8 bolts. Detail the connection.
- A single unequal angle 100 x 75 x 6 mm is connected to a 8 mm thick gusset plate at the ends by 4 mm welds. The welded connection is designed for the full tensile capacity of the cross section. Determine the length of weld
 - if the gusset is connected to the 100 mm leg.
 - if the gusset is connected to the 75 mm leg.

The yield strength and ultimate strength of the steel used are 250 MPa and 410 MPa and the grade of electrode is E51.

Course Outcome 5 (CO5):

- State the limitations of lower bound and upper bound theorem.
- Determine the required plastic moment capacity for the loads $w_1=10\text{kN/m}$, $P_1=50\text{kN}$, $w_2=40\text{kN/m}$, $P_2=60\text{kN}$. State the specialty of this type of loading if any.

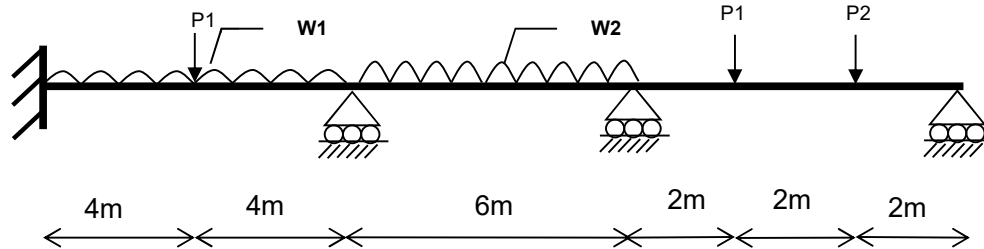

- Find the plastic section modulus for the below given cross section.

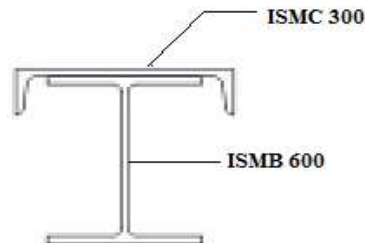

Course Outcome 6 (CO6):

- Determine the load carrying capacity of a built-up column section made of ISMB400 with flange plates of size 250 x 20mm. The effective length of the column is 6m.
- Design a slab base for a column section of ISHB 400 @ 822 N/m supporting an axial load of 700 kN. The base plate is to rest on a concrete pedestal of M20 grade concrete.
- An ISHB 350 @ 710.2 N/m stanchion is supported on a slab base having 500 x 400 x 16 mm. The cleat angles of 60 x 60 x 10 mm are connected to the flange of the stanchion by 2 nos. of M20 bolts of grade 4.6 to keep the stanchion in position. Base plate is connected to the concrete pedestal of size 1 x 1 x 0.5 m using 4 anchor bolts of 20 mm dia. having 250 mm length. Draw to a suitable scale the following:
 - Sectional elevation
 - Plan of slab base giving all details.

Concept Map

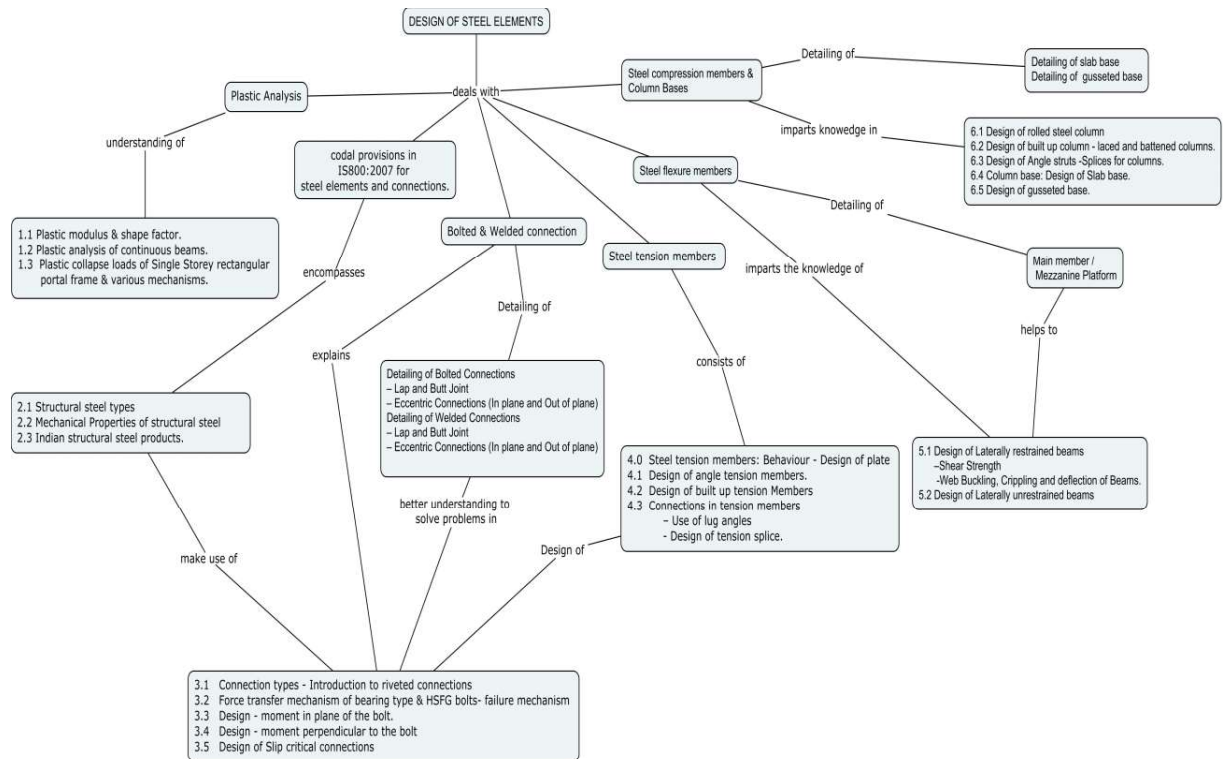

Syllabus

Introduction of Structural steel Structural steel types, Mechanical Properties of structural steel, Indian structural steel products. **Design Philosophy of steel structures:** Introduction, Working stress method, Limit state method, Classification of cross sections, IS800:2007 related provisions. **Bolted connection:** Connection types, Introduction to riveted connections, Force transfer mechanism of bearing type & HSFG bolts, failure mechanism, Design, direct tension, compression, moment in plane of the bolt, moment perpendicular to the bolt, Design of Slip critical connections **Welded connection:** Type of welds, joints, strength of welds, Design, direct tension, compression, moment in plane of the weld, moment perpendicular to the weld. **Tension members:** Behaviour, Design of plate and angle tension members, design of built up tension Members, Connections in tension members, Use of lug angles, Design of tension splice. **Compression members:** Type of Column sections, Design, rolled steel section, built up section, laced and battened columns, Angle struts, Splices for columns. **Column base:** Slab base and gusseted base. **Plastic Analysis:** Theory & assumptions yield criteria, plastic modulus & shape factor, plastic analysis of continuous beams, Plastic collapse loads of Single Storey rectangular portal frame & various mechanisms. **Flexure members:** Behaviour - Design, simple and compound beams, laterally restrained, laterally unrestrained, Factors affecting lateral stability, Shear Strength, Web Buckling, Crippling and deflection of Beams.

Indian Standard Codes

1. IS: 800 – 2007, Code of Practice for general construction in steel, BIS, New Delhi
2. SP 6 (1) – Structural steel sections, BIS, New Delhi
3. IS: 816 - 1969, Code of practice for use of metal arc welding for general construction in mild steel.
4. IS: 808 – 1989 Dimensions For Hot Rolled Steel Beam, Column, Channel and Angle Sections.

Learning Resources

1. Duggal S.K., "Limit state design of steel structures" McGraw Hill Co., New Delhi, 2014

2. Teaching Resource for Structural Steel Design, Vol. 1,2,3 (2000), INSDAG- Institute for Steel Development and Growth, Kolkatta.
3. Subramanian, N., (2008), Design of Steel Structures, oxford university press, USA,.
4. Gaylord E H, Gaylord N C and Stallmeyer J E, "Design of Steel Structures", 3rd edition, McGraw Hill Publications, 1992.
5. Salmon, Johnson & Malhas," Steel Structures: Design and Behavior, 4th Edition,Harper Collins College Publisher, 1996
6. Negi L.S. "Design of steel structures" McGraw Hill Co., New Delhi, 2014
7. www.nptel.ac.in
8. http://www.steel-insdag.org/TM_Content.asp

Course Contents and Lecture Schedule			
Module No.	Topic	No. of Hours	Course Outcome
1	Introduction of Structural steel		
1.1	Structural steel types – Mechanical Properties of structural steel- Indian structural steel products.	1	CO1
1.2	Design Philosophy of steel structures: Introduction – Working stress method – Limit state method	1	
1.3	Classification of cross sections- IS800:2007 related provisions.	1	
1.4	Bolted connection: Connection types & Introduction to riveted connections.	1	
1.5	Force transfer mechanism of bearing type & HSFG bolts- failure mechanism.	2	
1.6	Design of bolted connection - direct tension – compression.	2	
1.7	Design of bolted connection - moment in plane of the bolt	2	
1.8	Design of bolted connection - moment perpendicular to the bolt	2	
1.9	Design of Slip critical connections	2	
2	Welded connection		
2.1	Type of welds, joints - strength of welds.	1	CO2
2.2	Design of welded connection - moment in plane of the weld	2	
2.3	Design of welded connection - moment perpendicular to the weld	2	
3	Tension members: Behaviour - Design of plate	1	CO3
3.1	Design of angle tension members.	2	
3.2	Design of built up tension Members	2	
3.3	Connections in tension members – Use of lug angles - Design of tension splice.	2	
4	Compression members: Type of Column sections.	1	CO4
4.1	Design of rolled steel column	2	
4.2	Design of built up column - laced and battened columns.	2	
4.3	Design of Angle struts -Splices for columns.	2	
4.4	Column base: Design of Slab base.	2	
4.5	Design of gusseted base.	2	
5	Plastic Analysis		
5.1	Theory & assumptions yield criteria, plastic modulus.	1	CO5
5.2	shape factor - plastic analysis of continuous beams.	2	
5.3	Plastic collapse loads of Single Storey rectangular portal frame & various mechanisms.	2	

6	Flexure members: Behaviour - Design - simple and compound beams	2	CO6
6.1	Design of Laterally restrained beams –Shear Strength-Web Buckling, Crippling and deflection of Beams.	2	
6.2	Design of Laterally unrestrained beams - Factors affecting lateral stability	2	

List of Exercises for Detailing part - Assignments

Module No.	Exercise Details
1.	Detailing of Bolted Connections – Lap and Butt Joint
2.	Detailing of Bolted Connections – Eccentric Connections (In plane and Out of plane)
3.	Detailing of Welded Connections – Lap and Butt Joint
4.	Detailing of Welded Connections – Eccentric Connections (In plane and Out of plane)
5.	Detailing of Tension Members – Plate / angle
6.	Detailing of Tension Members splices
7.	Detailing of column splices
8.	Detailing of column and slab base
9.	Detailing of column and gusseted base
10.	Detailing of Flexural Members – Main member / Mezzanine Platform with simple end connections.

Course Designers:

1. Dr.S.Arulmary samciv@tce.edu
2. Ms. G.Celine Reena celinereena@tce.edu

18CE570	MATERIALS TESTING LAB				
	Category	L	T	P	Credit
	PC	0	0	2	1

Preamble

Students of Civil engineering would get exposure in the properties of engineering materials and to identify the behaviour of the given material.

Prerequisite

Fundamentals of Mathematics, strength of materials and Concrete technology.

Course Outcomes

On the successful completion of the course students will be able to

CO Number	Course Outcome Statement	Weightage*** in %
CO1	Determine the behaviour of structural elements, such as bars, beams and springs subjected to tension, compression, shear, bending and torsion.	40
CO2	Determine the physical properties of constituent material of concrete.	15
CO3	Determination the properties of fresh concrete.	15
CO4	Determine the properties of hardened concrete.	10
CO5	Design concrete mixes and apply statistical quality control techniques	10
CO6	Explain durability behaviour of concrete	10

*** Weightage depends on Bloom's Level, number of contact hours

CO Mapping with CDIO Curriculum Framework

CO #	TCE Proficiency Scale	Learning Domain Level			CDIO Curricular Components(X.Y.Z)
		Cognitive	Affective	Psychomotor	
CO1	TPS3	Apply	Value	Mechanism	1.1.1, 1.1.2, 1.2, 2.1.5, 2.2.3, 3.2.5
CO2	TPS3	Apply	Value	Mechanism	1.1.1, 1.1.2, 1.2, 2.1.5, 2.2.3, 3.2.5
CO3	TPS3	Apply	Value	Mechanism	1.1.1, 1.1.2, 1.2, 2.1.5, 2.2.3, 3.2.5
CO4	TPS3	Apply	Value	Mechanism	1.1.1, 1.1.2, 1.2, 2.1.5, 2.2.3, 3.2.5
CO5	TPS3	Apply	Value	Mechanism	1.1.1, 1.1.2, 1.2, 2.1.5, 2.2.3, 3.2.5
CO6	TPS2	Understand	Respond	Guided response	1.2, 2.1.4, 3.1, 4.4.2

Mapping with Programme Outcomes and Programme Specific Outcomes

Cos	PO1	PO2	PO3	PO4	PO5	PO6	PO7	PO8	PO9	PO10	PO11	PO12	PSO1	PSO2
-----	-----	-----	-----	-----	-----	-----	-----	-----	-----	------	------	------	------	------

CO 1	S	M	L	-	-	-	-	-	-	L	-	-	L	L
CO 2	S	M	L	-	-	-	-	-	-	L	-	-	L	L
CO 3	S	M	L	-	-	-	-	-	-	L	-	-	L	L
CO 4	S	M	L	-	-	-	-	-	-	L	-	-	M	L
CO 5	S	M	L	-	-	-	-	-	-	L	-	-	L	L
CO 6	M	L	-	-	-	-	-	-	-	L	-	-	L	L

S- Strong; M-Medium; L-Low

Assessment Pattern: Cognitive Domain

Cognitive Levels	Model Examination	Terminal Examination
Remember	--	--
Understand	20	20
Apply	80	80
Analyse	--	--
Evaluate	--	--
Create	--	--

Assessment Pattern: Psychomotor

Psychomotor Skill	Mini Project / Practical Component / Observation
Perception	---
Set	---
Guided Response	50
Mechanism	50
Complex Overt Responses	---
Adaptation	---
Origination	---

List of Experiments / Activities with CO Mapping

Part A: Strength of Materials Lab. (Any six experiments are to be conducted)

S.No	Description (Cycle 1)	No of Hours	Course Outcome
1.	Determination of the Young's Modulus of Steel by conducting tension test in UTM.	2	CO1
2.	Determination of the Young's Modulus of the beam (Steel, Wood, Aluminium etc.) by conducting the bending test.	2	
3.	Determination of the Young's Modulus of the beam (Steel, Wood, Aluminium etc.) by conducting the bending test using Huggen Berger Tensometer.	2	
4.	Determination of the rigidity modulus of the material by conducting torsion test.	2	
5.	Determination of the rigidity modulus of the compression and tension spring by conducting spring test.	2	
6.	Determination of the Young's Modulus of the beam (Steel, wood, Aluminium etc.) by conducting the deflection test in UTM	2	
7.	Determination of Brinell hardness and Rockwell hardness for	2	

	Steel, Copper, Aluminium and Brass.		
	Total Hours	12	

Part B: Concrete Lab

S.No	Description (cycle 2)	No of Hours	Course outcome
1.	Determination of Consistency and setting time of cement	2	CO2
2.	Determination of Bulk Density, Specific gravity, void ratio of fine and coarse aggregates.	2	
3.	Determination of fineness modulus and grading zone of fine and coarse aggregates.	2	
4.	Determination of Maximum bulk of fine aggregate.	2	
5.	Determination of workability of concrete by slump test	2	CO3
6.	Determination of workability of concrete by compaction factortest	2	
	Total Hours	12	

Demonstration Exercises

S.No	Description	Course outcome
1.	Test on hardened concrete (cube compressive strength, split tensile test, flexure test)	CO4
2.	Determination of elastic modulus of concrete.	
3.	Design of concrete by IS method.	CO5
4.	Durability properties of concrete.	CO6

Learning Resources

1. S S Rattan., Strenth of Material, McGraw Hill Educational Private (india)Limited.2011
2. Rajput., Strength of materials, S.Chand publishers, 4th edition, 2006
3. Junnarkar, S.B. & Shah, H.J., Mechanics of structures, vol.I, II, Charotar Publishing House, India, 1999.
4. A.M.Neville, Properties of concrete, 4th edition,1996.
5. M.S.Shetty , Concrete Technology, AMIE publications,1982

Course Designers:

1. Dr. D. Brindha dbciv@tce.edu
2. Dr. S. Nagan nagan_civil@tce.edu

18CE580	ENVIRONMENTAL ENGINEERING LAB				
	Category	L	T	P	Credit
	PC	0	0	2	1

Preamble

This laboratory course work is intended to impart hands on training in evaluating the water quality parameters, wastewater characteristics and ambient air quality status measurements. This will form the basic input data for arriving at a solution/treatment for upkeep of the environment and promoting public health.

Prerequisite

Fundamentals of Mathematics, Water supply Engineering, Wastewater Engineering

Course Outcomes

On the successful completion of the course students will be able to

CO Number	Course Outcome Statement	Weightage*** in %
CO1	Fix the chemical characteristics of Water from different sources.	20
CO2	Fix the chemical characteristics of Wastewater of different sources.	20
CO3	Conduct experiments to find optimum coagulant dosage for suspended solids removal from water and wastewater samples.	10
CO4	Obtain the correct dosage of lime and soda needed for the removal of hardness from water.	10
CO5	Fix the chlorine dosage needed for the effective disinfection of water & wastewater samples.	10
CO6	Measure the ambient air quality parameters such as Particulate Matter, NO _x and SO _x .	10
CO7	Perform physical Characterization of municipal solid waste.	10
CO8	Assess the noise level in an area.	10

*** Weightage depends on Bloom's Level, number of contact hours,

CO Mapping with CDIO Curriculum Framework

CO #	TCE Proficiency Scale	Learning Domain Level			CDIO Curricular Components (X.Y.Z)
		Cognitive	Affective	Psychomotor	
CO1	TPS3	Apply	Value	Mechanism	1.1.1, 1.1.2, 1.2, 2.5.1, 3.1.1, 3.1.5, 3.2.5.
CO2	TPS3	Apply	Value	Mechanism	1.1.1, 1.1.2, 1.2, 2.5.1, 3.1.1, 3.1.5, 3.2.5.
CO3	TPS3	Apply	Value	Mechanism	1.1.1, 1.1.2, 1.2, 2.5.1, 3.1.1, 3.1.5, 3.2.5.
CO4	TPS3	Apply	Value	Mechanism	1.1.1, 1.1.2, 1.2, 2.5.1, 3.1.1, 3.1.5, 3.2.5.
CO5	TPS3	Apply	Value	Mechanism	1.1.1, 1.1.2, 1.2, 2.5.1, 3.1.1, 3.1.5, 3.2.5.
CO6	TPS3	Apply	Value	Mechanism	1.1.1, 1.1.2, 1.2, 2.5.1, 3.1.1, 3.1.5, 3.2.5.

Mapping with Programme Outcomes and Programme Specific Outcomes

COs	PO1	PO2	PO3	PO4	PO5	PO6	PO7	PO8	PO9	PO10	PO11	PO12	PSO1	PSO2
CO1	S	M	L	-	-	M	S	L	L	S	-	M	L	M
CO2	S	M	L	-	-	M	S	L	L	S	-	M	L	M
CO3	S	M	L	-	-	M	S	-	L	M	-	-	L	L
CO4	S	M	L	-	-	L	S	-	L	M	-	-	L	L
CO5	S	M	L	-	-	S	S	L	L	M	-	M	L	M
CO6	S	M	L	-	-	S	S	-	L	S	-	L	L	M
CO7	S	M	L	-	-	S	S	L	L	S	-	-	L	M
CO8	S	M	L	-	-	S	S	-	L	S	-	L	L	M

S- Strong; M-Medium; L-Low

Assessment Pattern: Cognitive Domain

Cognitive Levels	Model Examination	Terminal Examination
Remember	-	-
Understand	-	-
Apply	100	100
Analyse	-	-
Evaluate	-	-
Create	-	-

Assessment Pattern: Psychomotor

Psychomotor Skill	Miniproject/Practical Component/Observation
Perception	-
Set	-
Guided Response	-
Mechanism	100
Complex Overt Responses	-
Adaptation	-
Origination	-

List of Experiments/Activities with CO Mapping

1. Determination of Hardness, Alkalinity and Chlorides in water sample.
2. Determination of Fluorides in drinking water – Spectro photometric analysis.
3. Determination of Sulphate in water sample – Turbiditymetric analysis.
4. Determination of Dissolved oxygen in drinking water.
5. Heavy metal measurement using AAS.
6. Optimum coagulant dosage for removal of turbidity in water.
7. Estimation of chlorine dosage for disinfection of water.
8. Determination of Total solids, suspended solids, Dissolved solids, Organic solids, Inorganic solids in water and wastewater samples.
9. Determination of Nitrates in water and wastewater – Spectro photometric analysis.
10. Determination of COD of wastewater samples.
11. Determination of Oil and greasy matters in wastewater samples.
12. Determination of Ammonia nitrogen in wastewater samples.
13. Determination of Phosphate in wastewater samples.
14. Measurement of Ambient air quality parameters – Particulate Matter, SO₂, NO_x

Demonstration

1. Determination of pH of water and wastewater.
2. Determination of BOD of wastewater.

3. Characterization of municipal solid waste and volatile component Estimation.

Learning Resources

1. American Public Health Association (APHA) 2005, Standard methods for the examination of water & wastewater. 21st edition, Eaton, A.D., Clesceri, L.S., Rice, E.W., Greenberg, A.E., Franson, M.A.H. APHA, Washington.

IS CODE:

1. IS 3025 : Part 21 : 2009 Methods of sampling and test (Physical and Chemical) for water and wastewater : Hardness
2. IS 3025 : Part 23 : 1986 Methods of sampling and test (Physical and Chemical) for water and wastewater : Alkalinity
3. IS 3025 : Part 32 : 1988 Methods of sampling and test (Physical and Chemical) for water and wastewater : Chloride
4. IS 3025 : Part 34 : 1988 Methods of sampling and test (Physical and Chemical) for water and wastewater : Nitrate
5. IS 3025 : Part 24 : 1986 Methods of sampling and test (Physical and Chemical) for water and wastewater : Sulphate
6. IS 3025 : Part 60 : 2008 Methods of sampling and test (Physical and Chemical) for water and wastewater : Fluoride
7. IS 3025 : Part 10 : 1984 Methods of sampling and test (Physical and Chemical) for water and wastewater : Turbidity
8. IS 3025 : Part 16 : 1984 Methods of sampling and test (Physical and Chemical) for water and wastewater : FILTERABLE RESIDUE (TOTAL DISSOLVED SOLIDS)
9. IS 3025 : Part 11 : 1983 Methods of sampling and test (Physical and Chemical) for water and wastewater : pH VALUE
10. IS 3025 : Part 44 : 1993 Methods of sampling and test (Physical and Chemical) for water and wastewater : BIOCHEMICAL OXYGEN DEMAND (BOD)
11. IS 3025 : Part 39 : 1989 Methods of sampling and test (Physical and Chemical) for water and wastewater : Oil and Grease
12. IS 3025 : Part 58 : 2006 Methods of sampling and test (Physical and Chemical) for water and wastewater : CHEMICAL OXYGEN DEMAND (COD)
13. IS 3025 : Part 31 : 1988 Methods of sampling and test (Physical and Chemical) for water and wastewater : Phosphorous
14. IS 5182 : Part 2 : 2001 Methods for Measurement of Air Pollution : Sulphur dioxide
15. IS 5182 : Part 6 : 2006 Methods for Measurement of Air Pollution : Oxides of Nitrogen
16. IS 5182 : Part 23 : 2001 Methods for measurement of air pollution : Respirable Suspended Particulate Matter (PM10) cyclonic flow techniques.

Course Designers

1. Dr.T.VelRajan tciv@tce.edu
2. Ms.S.Sivasangari ssiciv@tce.edu
3. Ms.K.Keerthy kkciv@tce.edu

18CE610	FOUNDATION ENGINEERING				
	Category	L	T	P	Credit
	PC	3	0	0	3

Preamble

This course offers the theories and methods for accessing the subsurface condition at the construction site, determining the bearing capacity of shallow foundations, load carrying capacity of pile foundations, computing settlement of foundations, earth pressure acting on retaining walls and stability analysis of retaining walls.

Prerequisite

18CE520 - Soil Mechanics

Course Outcomes

On the successful completion of the course students will be able to

CO Number	Course Outcome Statement	Weightage in %
CO1	Plan detailed subsurface exploration program for determining the geotechnical parameters required for the design of foundations	20
CO2	Compute bearing capacity of shallow foundations and estimate settlement of footings	20
CO3	Suggest appropriate shallow foundation and Design their dimensions for equal settlement	10
CO4	Determine the load carrying capacity of pile foundations and pile groups	20
CO5	Explain ground improvement techniques for cohesive and cohesionless soils.	10
CO6	Calculate the lateral earth pressure on retaining walls and check their stability.	20

CO Mapping with CDIO Curriculum Framework

CO #	TCE Proficiency Scale	Learning Domain Level			CDIO Curricular Components (X.Y.Z)
		Cognitive	Affective	Psychomotor	
CO1	TPS3	Apply	Value	Mechanism	1.1.1,1.1.2,1.2,2.1.1,2.1.3,2.1.5, 2.4.2,2.4.6,2.5.1,3.1.1,3.1.2,3.1.4, 3.1.5,3.2.3,4.1.1,4.1.2,4.3.4
CO2	TPS3	Apply	Value	Mechanism	1.1.1,1.1.2,1.2,2.1.1,2.1.3,2.1.5, 2.4.2,2.4.6,2.5.1
CO3	TPS3	Apply	Value	Mechanism	1.1.1,1.1.2,1.2,2.1.1,2.1.3,2.1.5, 2.4.2,2.4.6,2.5.1
CO4	TPS3	Apply	Value	Mechanism	1.1.1,1.1.2,1.2,2.1.1,2.1.3,2.1.5, 2.4.2,2.4.6,2.5.1
CO5	TPS2	Understand	Respond	Guided Response	1.1.1,1.1.2,1.2,2.1.1,2.1.3,2.1.5, 2.4.2,2.4.6,2.5.1

CO6	TPS3	Apply	Value	Mechanism	1.1.1,1.1.2,1.2.2.1.1,2.1.3,2.1.5, 2.4.2,2.4.6,2.5.1
-----	------	-------	-------	-----------	---

Mapping with Programme Outcomes and Programme Specific Outcomes

Cos	PO1	PO2	PO3	PO4	PO5	PO6	PO7	PO8	PO9	PO10	PO11	PO12	PSO1	PSO2
CO 1	S	M	L	-	-	L	-	S	S	S	L	M	M	M
CO 2	S	M	L	-	-	L	-	S	M	M	-	L	M	L
CO 3	S	M	L	-	-	M	-	S	M	M	-	L	M	L
CO 4	S	M	L	-	-	M	-	S	M	M	-	L	M	L
CO 5	M	L	-	-	-	M	-	M	S	S	L	M	L	M
CO 6	S	M	L	-	-	M	-	M	M	M	-	L	M	L

S- Strong; M-Medium; L-Low

Assessment Pattern: Cognitive Domain

Cognitive Levels	Continuous Assessment Tests			Assignment			Terminal Examination
	1	2	3	1	2	3	
Remember	10	10	10	-	-	-	10
Understand	10	10	10	-	-	-	10
Apply	80	80	80	100	100	100	80
Analyse							
Evaluate							
Create							

Assessment Pattern: Psychomotor

Psychomotor Skill	Mini project/Assignment/Practical Component
Perception	-
Set	-
Guided Response	70
Mechanism	30
Complex Overt Responses	-
Adaptation	-
Origination	-

Sample Questions for Course Outcome Assessment**

Course Outcome1(CO1):

1. Explain the factors to be considered while planning a subsurface exploration program.
2. How would you fix the depth and spacing of boreholes for subsurface exploration?

3. Subsoil at a construction site comprises of cohesionless soil deposit extending for a large depth. Suggest an appropriate in-situ penetration test for subsurface exploration and explain its procedure. How the test results are correlated to various soil properties?

Course Outcome2(CO2):

1. Determine the safe load that can be carried by a rectangular footing of 3m x 2m size, placed at a depth of 1.8m below the G.L. The foundation soil has the following properties:
 $\gamma = 17 \text{ kN/m}^3$, $C = 20 \text{ kN/m}^2$ and $\phi = 20^\circ$.
 Assume a factor of safety of 2.5 and take $N_c' = 11.8$, $N_q' = 3.8$ and $N_\gamma' = 1.3$. Use BIS procedure.
2. Estimate the Immediate Settlement of a rigid concrete footing, 1m x 2m size, founded at a depth of 1m in a soil with $E = 10^4 \text{ kN/m}^2$, $\mu = 0.35$. The footing is subjected to a pressure of 230 kN/m^2 . Assume Influence coefficient as 1.2.
3. A Rectangular footing 1.5m x 2m is located in a deposit of dense sand at a depth of 1.8m below the surface. The moist unit weight of the sand above the water table is 17.5 kN/m^3 and the saturated unit weight is 19.5 kN/m^3 . Water table may rise upto the base of the footing during rainy season. Take $C = 0$, $\phi = 35^\circ$ and from SPT, $N_{\text{corrected}} = 25$. Take $N_q = 33$ and $N_\gamma = 37$. Calculate the net allowable bearing capacity considering shear failure (Use Terzaghi's equation) and a permissible settlement of 25mm.

Course Outcome 3(CO3):

1. Explain the concept of Floating Foundation.
2. Design a rectangular combined footing to support two adjacent columns (size 40 cm x 40 cm) at a distance of 5 m carrying loads of 3 MN and 4 MN. The lighter column is near the property line. The allowable soil pressure is 400 kN/m^2 .
3. Design a trapezoidal combined footing for two adjacent columns (size 30 cm x 30 cm) at a distance of 4 m carrying loads of 1.2 MN and 0.9 MN. Take the allowable soil pressure as 200 kN/m^2 and the length of the footing as 5 m.

Course Outcome 4 (CO4):

1. A pile of 0.3m diameter is driven through a clayey stratum upto a depth of 10m. It is observed that the undrained cohesion varies from 12 kN/m^2 at its surface to 65 kN/m^2 at a depth of 10 m. Determine the safe load on the pile with a factor of safety of 3.0
2. A 16-pile group has to be arranged in the form of square in soft clay with uniform spacing. Neglecting end bearing, determine the optimum value of the spacing of the piles in terms of the pile diameter, assuming shear mobilization factor of 0.5.
3. Explain Downward drag phenomena in piles.

Course Outcome 5 (CO5):

1. Recall the need for dewatering.
2. Explain Precompression method of soil stabilization.
3. Explain Vibroflotation method for improvement of Cohesionless soil deposit.

Course Outcome 6(CO6):

1. Differentiate Active and Passive earth pressures.
2. Determine the total active earth pressure per meter length acting on a gravity retaining wall with the following data:

Height of the wall = 3.5m

Backfill surface is horizontal

Backfill soil extending from the top of the wall upto a height of 1.5m has the following properties: $C = 0$, $\phi = 33^\circ$ and $\gamma = 18 \text{ kN/m}^3$.

Backfill soil extending below the above mentioned top layer has the following properties: $C = 0$, $\phi = 30^\circ$, $\gamma = 17.5 \text{ kN/m}^3$ and $\gamma_{\text{sat}} = 19.5 \text{ kN/m}^3$.

Water table is at a depth of 1.5m below the top of the wall.

3. Masonry retaining wall is 1.0 m wide at top, 2.5 m wide at base and 4 m high. It is trapezoidal in section and has a vertical face on the earth side. The backfill is inclined at an angle of 15° with the horizontal. The angle of internal friction of the fill = 30° and the unit weight of the fill is 16 kN/m^3 . The unit weight of the masonry is 23 kN/m^3 . Take angle of friction = 25° and the allowable bearing capacity of the soil as 400 kN/m^2 . Check the stability of the retaining wall.

Concept Map

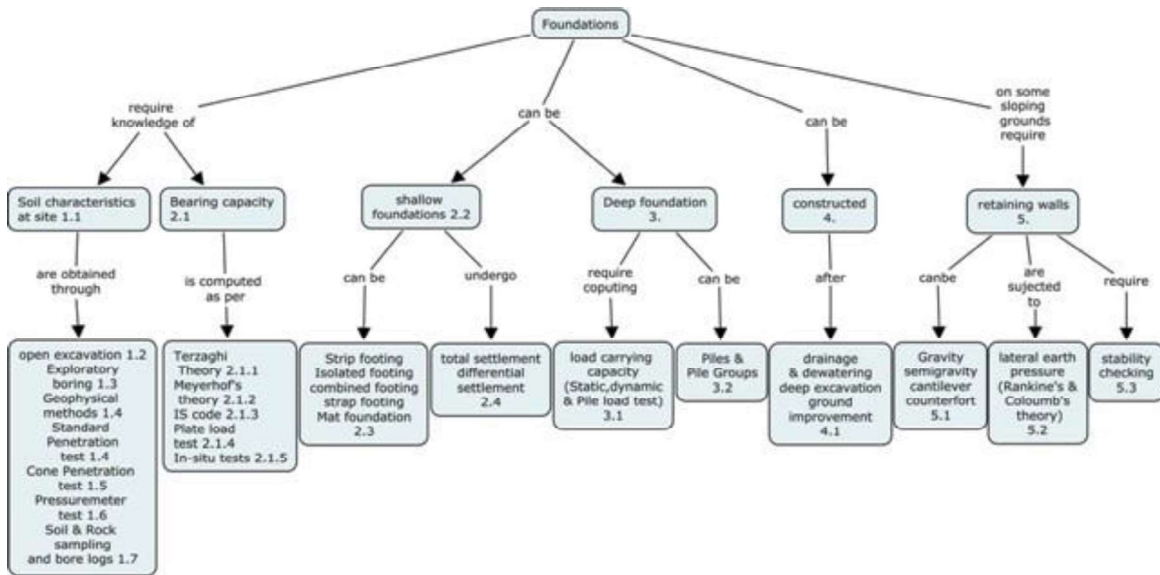

Syllabus

Subsurface Exploration and Site investigation: Objectives of Site Investigation - Stages - Planning - Methods of Site Investigation - Depth and Spacing of bore holes - Penetration Tests (SPT and SCPT) - Disturbed and Undisturbed samples - Sampling techniques - Split Spoon sampler - Thin walled sampler - Stationary Piston sampler - Rock Sampling - RQD - Use of Bore log. **Bearing Capacity and Settlement of Foundation:** Types of Bearing Capacity - Terzaghi's theory and BIS Formula - Factors affecting bearing capacity - Bearing Capacity from insitu tests (SPT, SCPT and Plate Load Test) - Types of settlement - Allowable settlement - Determination of settlement of foundations in granular and clay deposit - Codal Provisions - Contact Pressure. **Shallow Foundations:** Functions - Requisites of foundation - Types of shallow foundations - Selection of Foundation based on soil condition - Conventional procedure for proportioning of foundations for equal settlement - Floating foundation. **Deep Foundations:** Consideration leading to selection of pile foundation - Functions and Types of pile foundation - Construction of Piles - Estimating load carrying capacity of piles by Static formula - Dynamic Formulae - Pile Load Test - Negative skin friction in piles - Use of under-reamed piles in expansive soils - Pile Group - Efficiency and Load Carrying capacity of Pile Group. **Ground Improvement Techniques:** Drainage and dewatering techniques - Introduction to different ground

improvement techniques and their suitability. **Lateral earth Pressure and Retaining Walls:** Types of lateral earth pressure - Rankine's Earth Pressure Theory for cohesive and non cohesive backfill- Coulomb's earth pressure theory -Types of retaining walls - Design principles of Gravity and Cantilever retaining walls - Reinforced earth walls (concept)

Learning Resources

1. Braja M. Das, "Principles of Foundation Engineering", Eighth Edition, Thomson (India edition), 2014.
2. Murthy, V.N.S, "Soil Mechanics and Foundation Engineering", CBS Publishers Distribution Ltd., New Delhi, 2015.
3. GopalRanjan and Rao, A.S.R., "Basic and Applied Soil Mechanics", New Age International (P) Limited, Publishers New Delhi (India), 2013.
4. Dr. Arora,K. R., "Soil Mechanics and Foundation Engineering", Standard Publishers Distributors, New Delhi, 2015.
5. Donald P. Coduto, "Foundation Design – Principles and Practices", Prentice Hall, New Jersey, 2012.
6. NPTEL Material <https://nptel.ac.in/courses/105101083/>

IS Code of practice :

- IS: 1080(1985) – Design and construction of Shallow Foundations in soils.
- IS: 1888(1982) – Method of load test on soils.
- IS: 1892(1979) – Code of practice for Subsurface investigation for foundations.
- IS: 1904(1986) – Design and construction of Foundations in soils, General requirements.
- IS: 2131(1981) – Method for Standard Penetration test for soils.
- IS: 6403(1981) – Code of practice for determination of Bearing capacity of Shallow Foundations.
- IS: 2911 Part 1 Sec. 1(1979) – Design and construction of pile foundations –Drive cast in-situ concrete piles.
- IS: 2911 Part 1 Sec. 3(1979) – Design and construction of pile foundations –Drive precast piles.
- IS: 2911 Part 3 (1980) – Code of practice for Design and construction of pile foundations – Under-Reamed piles.
- IS: 2911 Part 4 (1985) – Load Test on Piles.
- IS: 8009 Part 1 (1976) – Code of practice for Calculation of Settlements of Foundations – Shallow Foundations subjected to symmetrical static vertical loads.

Course Contents and Lecture Schedule

Module No.	Topic	No. Of Hours	Course Outcome
1.	Subsurface Exploration and Site investigation		
1.1	Objectives of Site Investigation – Stages –Planning	1	CO1
1.2	Methods of Site Investigation – Depth and Spacing of bore holes	2	
1.3	Penetration Tests (SPT and SCPT)	2	
1.4	Disturbed and Undisturbed samples – Sampling techniques –Split Spoon sampler – Thin walled sampler – Stationary Piston sampler	1	
1.5	Rock Sampling – RQD – Use of Bore log	1	
2.	Bearing Capacity and Settlement of Foundation		
2.1	Types of Bearing Capacity – Terzaghi's theory and	2	CO2

	BIS Formula		
2.2	Factors affecting bearing capacity –Bearing Capacity frominsitu tests (SPT, SCPT and Plate Load Test)	2	
2.3	Types of settlement – Allowable settlement –	1	
2.4	Determination of settlement of foundations in granular and clay deposit – Codal Provisions – Contact Pressure	2	
3.	Shallow Foundations		
3.1	Functions – Requisites of foundation –Types of shallow foundations – Selection of Foundation based on soil condition	2	CO3
3.2	Conventional procedure for proportioning of foundations for equal settlement	2	
3.3	Floating foundation	1	
4.	Deep Foundations		
4.1	Consideration leading to selection of pile foundation – Functions and Types of pile foundation – Construction of Piles	2	CO4
4.2	Estimating load carrying capacity of piles by Static formula	2	
4.3	Dynamic Formulae – Pile Load Test	2	
4.4	Negative skin friction in piles – Use of under-reamed piles in expansive soils	1	
4.5	Pile Group – Efficiency and Load Carrying capacity of Pile Group	1	
5.	Ground Improvement Techniques		
5.1	Drainage and dewatering techniques	1	CO5
5.2	Introduction to different ground improvement techniques and their suitability	2	
6.	Lateral earth Pressure and Retaining Walls		
6.1	Types of LateralEarth pressure	1	CO6
6.2	Rankine'sEarth Pressure Theory for cohesive and non cohesivebackfill	1	
6.3	Coulomb's earth pressure theory	1	
6.4	Types of retaining walls – Design principles of Gravity and Cantilever retaining walls	2	
6.5	Reinforced earth walls (concept)	1	
	Total Hours	36	

Course Designers:

1. Dr. R. Sanjay Kumar

sanjaykumar@tce.edu

18CE620	HIGHWAY AND RAILWAY ENGINEERING				
	Category	L	T	P	Credit
	PC	3	0	0	3

Preamble

The course aims to make the students learn the principles of highways, their components and design of flexible and rigid pavements. Further, students will get acquainted with the treatment for failures and remedial measures during maintenance of pavements. This also imparts the student's knowledge of planning, design, construction and maintenance of railway tracks. The students acquire proficiency in the application of modern techniques such as GIS, GPS and remote sensing.

Prerequisite

Nil

Course Outcomes

On the successful completion of the course students will be able to

CO Number	Course Outcome Statement	Weightage*** in %
CO1	Understand the basic concepts of highway planning and apply them in geometric design of roads	25%
CO2	Understand the principles and design the flexible and rigid pavement using relevant IRC codes.	20%
CO3	Gain knowledge on testing procedures of highway materials and construction of different types of roads.	15%
CO4	Understand the basics of railway planning and apply them in design of various railway geometrics.	20%
CO5	Understand the functions of various components of railways, points and crossings.	10%
CO6	Understand the concepts of track maintenance and signalling in railways	10%

*** Weightage depends on Bloom's Level, number of contact hours.

CO Mapping with CDIO Curriculum Framework

CO #	TCE Proficiency Scale	Learning Domain Level			CDIO Curricular Components (X.Y.Z)
		Cognitive	Affective	Psychomotor	
CO1	TPS3	Apply	Value	Mechanism	1.1.1, 1.1.2, 1.2, 2.1.1, 3.3
CO2	TPS3	Apply	Value	Mechanism	1.1, 1.1.2, 1.1.3, 1.2, 2.1.1, 2.2.3, 2.5.1, 2.5.4, 3.3, 4.4.1, 4.5.1
CO3	TPS2	Understand	Respond	Guided	1.1.1, 1.1.2, 1.1.3, 1.2 ,

				Response	3.3
CO4	TPS3	Apply	Value	Mechanism	1.1.1, 1.1.2, 1.1.3, 1.2, 3.3
CO5	TPS2	Understand	Respond	Guided Response	1.1.1, 1.1.2, 1.1.3, 1.2, 3.3
CO6	TPS3	Understand	Respond	Guided Response	1.1.1, 1.1.2, 1.1.3, 1.2, 2.1.1, 2.2.3, 2.5.1, 2.5.4, 3.3, 4.4.1, 4.5.1

Mapping with Programme Outcomes and Programme Specific Outcomes

Cos	PO 1	PO 2	PO 3	PO 4	PO 5	PO 6	PO 7	PO 8	PO 9	PO1 0	PO1 1	PO1 2	PSO1	PSO2
CO1	S	M	L	-	-	S	L	S	S	-	S	S	L	L
CO2	S	M	L	-	-	S	L	S	S	-	S	S	L	M
CO3	M	L	-	-	-	M	S	M	M	-	M	M	L	M
CO4	S	M	L	-	-	S	L	S	S	-	S	S	L	M
CO5	M	L	-	-	-	M	S	M	M	-	M	M	L	M
CO6	M	L	-	-	-	M	S	M	M	-	M	M	L	L

S- Strong; M-Medium; L-Low

Assessment Pattern: Cognitive Domain

Cognitive Levels	Continuous Assessment Tests			Assignment			Terminal Examination
	1	2	3	1	2	3	
Remember		-	30	-	-	40	-
Understand	20	40	70	20	40	60	40
Apply	80	60	-	80	60	-	60
Analyse	-	-	-	-	-	-	-
Evaluate	-	-	-	-	-	-	-
Create	-	-	-	-	-	-	-

Assessment Pattern: Psychomotor

Psychomotor Skill	Mini project /Assignment/Practical Component
Perception	-
Set	-
Guided Response	40
Mechanism	60
Complex Overt Responses	-
Adaptation	-
Origination	-

Sample Questions for Course Outcome Assessment**

** (2 to 3 at the cognitive level of course outcome)

Course Outcome 1(CO1):

1. State the role of Indian Roads congress in Highway planning.
2. Derive the expression for super elevation giving its relationship with gauge, Speed and radius of the curve.
3. Calculate OSD required on a two way highway, if the speed of overtaking vehicle are kmph. Assume average rate of acceleration of 2.1 kmph/sec. Assume all other data as per IRC. Draw a neat sketch of overtaking zone and show the position of sign post.

Course Outcome 2(CO2):

1. What is rigidity factor in design of highway pavement?
2. Design a new flexible pavement for a two lane undivided carriage way using the following data
Design CBR value = 5%
Initial Traffic on completion of construction = 300 cv per day
Average growth rate = 6% per year
Design life = 15 years
Vehicle Damage Factor Value (VDF) = 2.5
3. Design a cement concrete pavement using the following data.
Wheel load $P=5100\text{kg}$.
Modules of elasticity of cement concrete $E= 3\times 10^5\text{kg/cm}^2$
Poisson's ratio (μ) =0.15.
Radius of contact area (a) =15 cm.
Modules of sub grade reaction $K= 15 \text{ kg/cm}^3$.
Concrete flexural strength $f_r =40\text{kg/cm}^2$.
Co-efficient of thermal expansion $e =10\times 10^{-6}/\text{C}$.
Temperature variation $t= 16.4^\circ\text{C}$.
Contraction joint spacing $L = 4.5\text{m}$.

Course Outcome 3(CO3):

1. State the desirable properties of aggregates used in pavements.
2. Explain various failures in rigid pavement and flexible pavements and discuss suitable maintenance for failures.
3. Discuss the construction procedure for WBM roads.

Course Outcome 4 (CO4):

1. What is meant by sleeper density? State its importance
2. If a 8° curve track diverges from a main curve of 3° in an opposite direction in the layout of a B.G. yard, calculate the super elevation and the speed on the branch line, if the maximum speed permitted on the main line is 50kmph.
3. Calculate the equilibrium cant on broad gauge Curve track of 60 for an average speed of trains 50 kmph. Calculate the maximum permissible speed after allowing the maximum cant deficiency.

Course Outcome 5 (CO5):

1. Explain the working principle of points and crossings with a neat sketch.
2. Explain the functioning and types of marshalling yard with neat sketch.
3. Write cole's method to determine the number of crossings.
4. State the various methods of plate laying and explain the methods of plate laying widely adopted in India.

Course Outcome 6 (CO6):

1. Explain the mechanism of interlocking with a help of a neat sketch.
2. Discuss briefly the locations and functions of different types of signals in a layout of railway station.
3. Describe the principle of track circuiting with neat sketch.

Concept Map

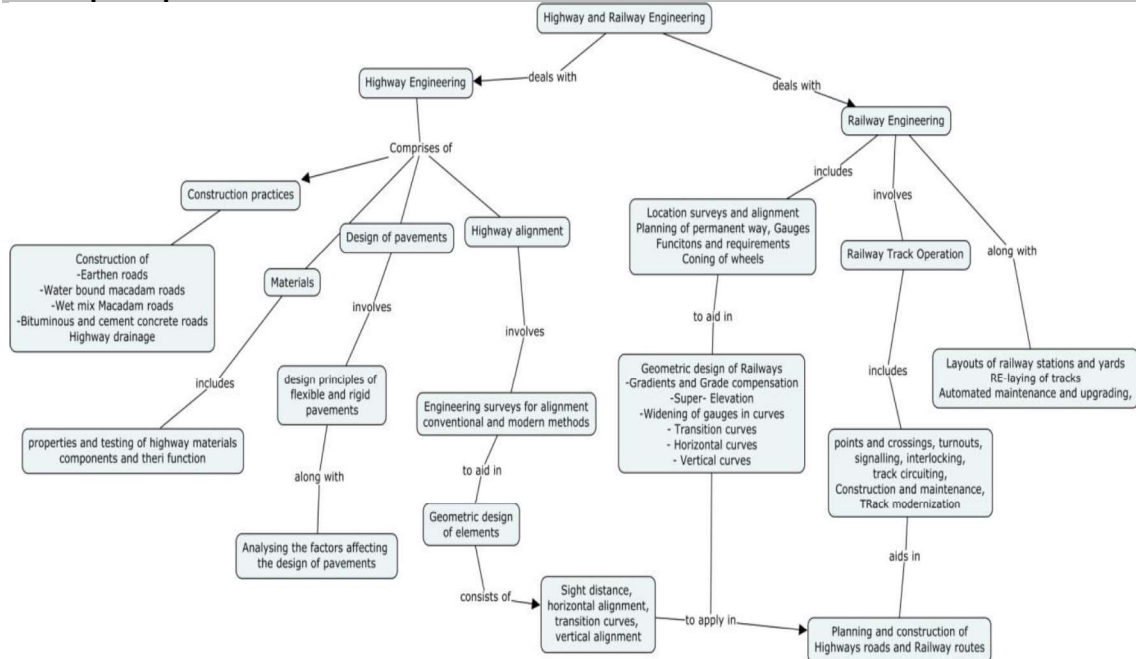

Syllabus

Highway alignment and geometric design of elements: History of road development in India, Engineering Surveys for Alignment – conventional and modern methods–Design of cross sectional elements- Sight Distance, horizontal alignment, transition curves, vertical alignment.

Highway materials and design of pavements: Properties and testing of Highway materials – Components of pavement and their functions- Design principles of flexible and rigid pavements- Factors affecting the design of pavements- climate, sub grade, soil and traffic- Design of flexible pavements- Design of rigid pavements.

Highway construction practice: Construction of roads – Earthen roads – Water Bound Macadam - Wet Mix Macadam roads – Bituminous, Polymer coated Aggregate Bituminous and Cement concrete roads - Highway Drainage. Maintenance of all types of roads – Distresses in pavements - Strengthening of pavements

Railway materials, planning and design: Role of Indian Railways in National Development – Location surveys and alignment - Conventional and Modern methods- Permanent way - Gauges - Components - Functions and requirements - Coning of Wheels

Geometric design of railway tracks: Gradients and Grade Compensation, Super-Elevation, Widening of Gauges in Curves, Transition Curves Horizontal and Vertical Curves.

Railway track construction, operation and maintenance: Points and Crossings - Turnouts – Types - Working Principle -Signalling, Interlocking and Track Circuiting - Construction and Maintenance – Conventional, Modern methods and Materials, Track Modernization– Automated maintenance and upgrading, Technologies, high speed track, Re-laying of Track, Layouts of Railway Stations and Yards, Rolling Stock, Tractive power, Track Resistance, Level crossings.

Text books

1. S.K Khanna, and C E G. Justo and A. Veeraragavan, "Highway Engineering", New Chand and Bros, Roorkee, 10th edition, 2015.
2. Kadiyali, L.R. and N.B.Lal, "Principles and practices of Highway Engineering", Khanna Publishers, 2018.
3. Saxena S.C and Arora S.P., "Railway Engineering", Dhanpat Rai Publications, 7th Edition, 2011
4. Satishchandra & MM Agarwal., "Railway Engineering", Oxford University Press, Second Edition, 2013

References

1. Sharma S.K, "Principles, Practice & Design of Highway Engineering", S.Chand and Co, 2014.
2. Rangwala S.C & K.S. "Railway Engineering", Charotar Publications, 14th Edition, 2008
3. Guidelines for the Design of Flexible Pavements, IRC: 37-2012, The Indian roads congress, New Delhi
4. Guidelines for the Design of Plain Jointed Rigid Pavements for Highways, IRC: 58-2015, The Indian Roads Congress, New Delhi.
5. Guidelines for the use of waste Plastic in Hot Bituminous mixes (Dry Process) in wearing courses, IRC:SP:98-2013 The Indian roads congress, New Delhi.

Course Contents and Lecture Schedule

S.No.	Topics	No. of Lectures	Course Outcome
1	Highway alignment and geometric design of elements		
1.1	History of road development in India – Jayakar committee recommendations, Vision 2021, NHAI and NHDP policies, PMGSY	1	CO1
1.2	Engineering Surveys for Alignment – conventional and modern methods (Remote sensing, GIS and GPS techniques), IRC Classification of roads	1	CO1
1.3	Geometric Standards - Highway cross sectional elements – carriageway, ROW, camber, kerbs, shoulders, footpath, drains	1	CO1
1.4	Sight Distance – Factors affecting Sight Distance – PIEV Theory – Stopping Sight Distance (SSD)	1	CO1
1.5	Overtaking Sight Distance (OSD) – Sight Distance at Intersection	1	CO1
1.6	Horizontal alignment – horizontal curves, Super elevation – derivation, problems, camber – methods of attainment	1	CO1
1.7	Widening on curves, transition curves - types	1	CO1
1.8	Vertical alignment - Ruling, Limiting, Exceptional and Minimum Gradients	1	CO1
1.9	Vertical Curves – types, design, shift in curves	1	CO1
2.	Highway materials and Design of pavements		
2.1	Properties of Highway materials – sub grade soil, Aggregates, bitumen-Types	1	CO3
2.2	Pavement components and their functions	1	CO2
2.3	Design principles of Flexible and Rigid Pavements, factors affecting design of pavements – ESWL	1	CO2
2.4	Sub grade soil and traffic, Design practice for Flexible Pavements	2	CO2
2.5	Design practice for Rigid Pavements	2	CO2
2.6	Joints in Rigid pavements - types	1	CO2

3.	Highway construction practice		
3.1	Construction practice - Water Bound Macadam , Wet Mix Macadam road, Bituminous, Polymer coated Aggregate Bituminous and Cement Concrete roads - Highway Drainage.	1	CO3
3.2	Highway Maintenance - Defects in flexible pavements – surface defects, disintegration – symptoms, causes and treatments	1	CO3
3.3	Failures in rigid pavements – Distresses in pavements	2	CO3
3.4	Pavement Evaluation - Pavement surface conditions		
3.5	Strengthening of pavement – Benkelman Beam Method		
4.	Railway materials, planning and design		
4.1	Role of Indian Railways in National Development – Railways for Urban Transportation – LRTS& MRTS	1	CO4
4.2	Engineering Surveys for Track Alignment – Obligatory points -Conventional and Modern methods (Remote Sensing, GIS & GPS, EDM and other equipments)	2	CO4
4.3	Permanent Way, its Components and their Functions: Rails – Types of Rails- Rail Fastenings	1	CO4
4.4	Concept of Gauges, Coning of Wheels, Creeps and kinks, Sleepers – Functions, Materials, Density, Materials, Ballast less tracks	2	CO4
5.	Geometric design of railway tracks		
5.1	Gradients and Grade Compensation, Super elevation,	1	CO5
5.2	Widening of Gauges in Curves, Transition Curves, Horizontal and Vertical Curves.	2	CO5
6.	Railway track construction, operation and maintenance		
6.1	Points and Crossings - Design of Turnouts, Working Principle	1	CO5
6.2	Signalling, Interlocking and Track Circuiting	1	CO6
6.3	Construction & Maintenance – Conventional, Modern methods and Materials- Track Modernisation – High Speed Tracks - Automated maintenance and upgrading technologies, Re-laying of Track	2	CO6
6.4	Layouts of Railway Stations and Yards, Rolling Stock, Tractive Power, Track Resistance, Level Crossings.	2	CO6
Total hours		36	

Course Designers:

1. Dr.R.Velkennedy rvkciv@tce.edu
2. Ms.S.Ayswarya saciv@tce.edu

18CE630	DATA STRUCTURES	Category	L	T	P	Credit
		PC	3	0	0	3

Preamble

This course will cover various data structures and their operations for manipulating them. Students will learn how to organize the data so that, the data can be accessed and updated efficiently using computer programs.

Prerequisite

18CE350 Programming for Problem solving

Course Outcomes

On the successful completion of the course, students will be able to

CO Number	Course Outcome Statement	Weightage*** in %
CO1	Compare algorithms using asymptotic notations based on time and space complexity (Understand)	10
CO2	Apply the concepts of stack and queue for suitable applications in trade off with time and space complexity. (Apply)	10
CO3	Illustrate the operations like insertion, deletion, traversing on the linear list data structure. (Apply)	15
CO4	Illustrate the operations like insertion, deletion, traversing on the non linear tree data structure. (Apply)	20
CO5	To store and uniformly distribute data in a hash table without collision. (Apply)	10
CO6	To retrieve the maximum and minimum data in a collection and merge data using appropriate heap. (Apply)	15
CO7	Sort data of different size using suitable sorting procedure. (Apply)	20

CO Mapping with CDIO Curriculum Framework

CO #	TCE Proficiency Scale	Learning Domain Level			CDIO Curricular Components (X.Y.Z)
		Cognitive	Affective	Psychomotor	
CO1	TPS3	Understand	Value	Guided Response	1.2, 2.1.2, 4.5.3
CO2	TPS3	Apply	Value	Guided Response	1.2, 2.1.2, 4.5.3
CO3	TPS3	Apply	Value	Guided Response	1.2, 2.1.2, 4.5.3
CO4	TPS3	Apply	Value	Guided Response	1.2, 2.1.2, 4.5.3
CO5	TPS3	Apply	Value	Guided Response	1.2, 2.1.2, 4.5.3
CO6	TPS3	Apply	Value	Guided Response	1.2, 2.1.2, 4.5.3
CO7	TPS3	Apply	Value	Guided Response	1.2, 2.1.2, 4.5.3

Mapping with Programme Outcomes and Programme Specific Outcomes

COs	PO 1	PO 2	PO 3	PO 4	PO 5	PO 6	PO 7	PO 8	PO 9	PO1 0	PO1 1	PO1 2	PSO 1	PSO 2
CO1	M	L						M		M				M
CO2	S	M	L					M		M				S
CO3	S	M	L					M		M				S
CO4	S	M	L					M		M				S
CO5	S	M	L					M		M				S
CO6	S	M	L					M		M				S
CO7	S	M	L					M		M				S

S- Strong; M-Medium; L-Low

Assessment Pattern: Cognitive Domain

Cognitive Levels	Continuous Assessment Tests			Assignment			Terminal Examination
	1	2	3	1	2	3	
Remember	20	20	10	-	-	-	10
Understand	20	20	10	20	20	20	10
Apply	60	60	80	80	80	100	80
Analyse							
Evaluate							
Create							

Assessment Pattern: Psychomotor

Psychomotor Skill	Assignments
Perception	
Set	20
Guided Response	80
Mechanism	
Complex Overt Responses	
Adaptation	
Origination	

Sample Questions for Course Outcome Assessment****Course Outcome 1 (CO1):**

1. Define Space Complexity and Time Complexity.
2. Define Efficiency of an algorithm/program and ways to determine it.
3. List down the four different asymptotic notations and their need.

Course Outcome 2 (CO2):

1. Create a Queue and demonstrate various operations in it.
2. Create a Stack and demonstrate various operations in it.
3. Demonstrate various applications of stack using suitable data.

Course Outcome 3(CO3)

1. Given an array and a singly linked list. Which of these data structures uses more memory space to store the same number of elements? Justify your answer.
2. Check whether a given string is a palindrome or not using a double linked list.
3. Solve the Josephus problem using a circular linked list.

Course Outcome 4 (CO4)

1. Perform the AVL algorithm for non AVL trees. In each case, count the number of updated links required by the AVL rotation. Given a simple expression tree, consisting of basic binary operators i.e., +, -, *, and / and some integers, write an algorithm to evaluate the expression tree.
2. Construct a binary tree using inorder and preorder traversal of the binary tree:
Inorder D, B, H, E, A, I, F, J, C, G
Preorder A, B, D, E, H, C, F, I, J, G
3. Construct binary tree. Show the step by step process with suitable algorithm.

Course Outcome 5 (CO5)

1. Given input {4371, 1323, 6173, 4199, 4344, 9679, 1989} and a hash function $h(x) = x \pmod{10}$, show the resulting
 - a. separate chaining hash table
 - b. hash table using linear probing, quadratic probing

- Consider implementing a hash table for an application in which we will build an initial hash table by inserting a substantial collection of records. After this, we expect that the number of insertions and the number of deletions performed to be roughly the same, although there may be long runs of consecutive insertions or consecutive deletions. Furthermore, the table will use a probe strategy to resolve any collisions that occur during insertion, and therefore we will "tombstone" cells from which a record has been deleted. If we implement the hash table described above, then when we search for a record, we cannot conclude the record is not in the table until we have found an empty cell in the table, not just a tombstone. (We will ensure that the table never reaches the state that there are no empty cells.) Explain carefully why the search cannot stop when a tombstone is encountered.
- Let $m = 17$, $h_1(x) = (k+15)\%m$, $h_2(x) = (4k+11)\%m$, and $h_3(x) = (7k+2)\%m$. Insert the keys 23, 7, 50, and 91 into the bit vector, and show the resulting vectors content. Then, find a key that is a false positive; that is, find a key that appears to have been inserted, but wasn't.

Course Outcome 6(CO6):

- For a binary heap stored in an array, the root is stored in position 1, the parent of node i is stored in position $\text{floor}(i/2)$, the left child is in position $2i$, and the right child is in position $2i+1$. What about a d -heap stored in an array? In what positions are the children and parent of node i stored? [Hint: to start, assume that the root is at position 0. Then modify your results to work with the root at position 1]
- Show the result of inserting keys 1 to 15 in order (i.e. 1 first, then 2 second, then 3 third, etc.) into an initially empty leftist heap. Use the leftist heap insert (i.e. merge) algorithm at each step. Show each step for this process.
- Prove or disprove: A perfectly balanced tree forms if keys 1 to $2k - 1$ are inserted in order (again this means 1 first, then 2 etc) into an initially empty leftist heap. k is a positive integer.

Course Outcome 7(CO7):

- Estimate the execution time of Bubble sort for an reverse order input.
- Recommend a suitable sorting procedure to operate on a large data set with justification.
- Apply quick sort to sort 11,9,13,8,5,7,6,4,18,3,19,1 in ascending order.

Concept Map

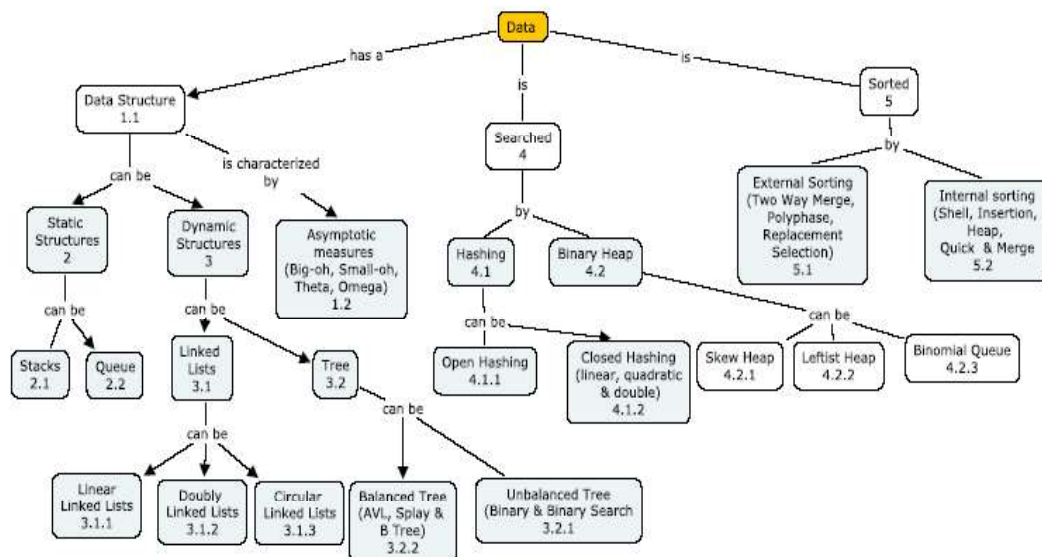

Syllabus

Data: Data Structure, Asymptotic Measures **Static Data Structures:** Stacks, Queues **Dynamic Data Structures:** Linked Lists: Linear Linked Lists, Doubly Linked Lists and Circular Linked Lists, Trees: Unbalanced and Balanced Trees, **Data Search:** Hashing: Open Hashing and Closed Hashing; Heap: Skew Heap, Leftist Heap, Binomial Queue **Data Sorting:** Internal Sorting: Insertion sorting, Shell sorting, Quick sorting, Merge sorting and Heap sorting; External Sorting

Learning Resources

1. Mark Allen Weiss , “Data Structures and Algorithm Analysis in C++”, Pearson, 2007
2. Adam Drozdek, “Data structures and Algorithms in C++”, Cengage Learning; 4th edition, 4th Edition, 2012.
3. Y. Langsam, M. J. Augenstein and A. N. Tanenbaum, “Data Structure Using C and C++”, Pearson Education, 2nd Edition, 2015.

Course Contents and Lecture Schedule

No.	Topic	No.of Lectures	Course Outcome
1	Data (4)		
1.1	Data Structure	2	CO1
1.2	Asymptotic Measures	2	CO1
2	Static Data Structures (4)		
2.1	Stacks	3	CO2
2.2	Queues	2	CO2
3	Dynamic Data Structures(14)		
3.1	Linked Lists	1	CO3
3.1.1	Linear Linked Lists	2	CO3
3.1.2	Doubly Linked Lists	2	CO3
3.1.3	Circular Linked Lists	1	CO3
3.2	Trees	1	CO4
3.2.1	Unbalanced Trees	2	CO4
3.2.2	Balanced Trees	5	CO4
4	Data Search (10)		
4.1	Hashing	1	CO5
4.1.1	Open Hashing	1	CO5

4.1.2	Closed Hashing	2	CO5
4.2	Heap	2	CO6
4.2.1	Skew Heap	1	CO6
4.2.2	Leftist Heap	2	CO6
4.2.3	Binomial Queue	1	CO6
5	Data Sorting (8)		
5.1	Internal Sorting		
5.1.1	Insertion sorting	1	CO7
5.1.2	Shell sorting	1	CO7
5.1.3	Quick sorting	1	CO7
5.1.4	Merge sorting	1	CO7
5.1.5	Heap sorting	2	CO7
5.2	External Sorting	2	CO7

Course Designers:

1. S.Prasanna

sprcse@tce.edu

18CE660	DESIGN OF REINFORCED CONCRETE ELEMENTS				
	Category	L	T	P	Credit
	PC	2	0	2	3

Preamble

The design of modern reinforced concrete structures may appear to be highly complex. However, most of these structures are the assembly of several basic structural elements such as beams, columns, slabs, walls and foundations. Accordingly, the designer has to learn the design of these basic reinforced concrete elements. This course offers the design of reinforced concrete elements such as beams, slabs, columns and footings using Limit State Method. This course follows the recommendations of IS 456:2000. It aims at determination of safe as well as economical sections and their reinforcements under various types of load combinations. At the end of this course, students will be able to identify and apply the design codes relevant to the design of reinforced concrete members and also they will be familiar with professional and ethical issues and the importance of lifelong learning in structural engineering.

Prerequisites

18CE220 Engineering Mechanics and 18CE510 Concrete Technology

Course Outcomes

On the successful completion of the course students will be able to

CO Number	Course Outcome Statement	Weightage*** in %
CO1	Explain the design concepts of structural reinforced concrete elements under various forces and interpret IS codal provisions	10
CO2	Design the structural reinforced concrete elements under flexure and detail the reinforcement	25
CO3	Design the structural reinforced concrete elements under shear, torsion, anchorage and development length and detail the reinforcement	15
CO4	Design the structural reinforced concrete elements under compression and detail the reinforcement	20
CO5	Check the serviceability requirements of reinforced concrete elements under deflection and cracking	10
CO6	Design the foundation and detail the reinforcement	20

*** Weightage depends on Bloom's Level, number of contact hours

CO Mapping with CDIO Curriculum Framework

CO #	TCE Proficiency Scale	Learning Domain Level			CDIO Curricular Components (X.Y.Z)
		Cognitive	Affective	Psychomotor	
CO1	TPS2	Understand	Respond	Guided Response	1.1.1, 2.1.1
CO2	TPS3	Apply	Value	Mechanism	1.1.1, 1.2, 1.3, 2.1.4, 2.1.5, 3.2.3
CO3	TPS3	Apply	Value	Mechanism	1.1.1, 1.2, 1.3, 2.1.4

CO4	TPS3	Apply	Value	Mechanism	1.1.1,1.2, 1.3, 2.1.4, 2.1.5, 3.2.3
CO5	TPS2	Understand	Respond	Guided Response	1.1.1, 2.1.1
CO6	TPS3	Apply	Value	Mechanism	1.1.1, 1.2, 1.3, 2.1.5, 2.4.4.

Mapping with Programme Outcomes and Programme Specific Outcomes

Cos	PO1	PO2	PO3	PO4	PO5	PO6	PO7	PO8	PO9	PO10	PO11	PO12	PSO1	PSO2
CO1	M	L	----	----	---	M	S	M	M	---	M	M	--	M
CO2	S	M	L	----	---	S	--	S	S	---	S	S	L	M
CO3	S	M	L	----	---	S	--	S	S	---	S	S	L	M
CO4	S	M	L	----	---	S	--	S	S	---	S	S	L	M
CO5	M	L	----	----	---	M	S	M	M	---	M	M	--	L
CO6	S	M	L	----	---	S	--	S	S	---	S	S	L	M

S- Strong; M-Medium; L-Low

Assessment Pattern: Cognitive Domain

Cognitive Levels	Continuous Assessment Tests			Assignment			Terminal Examination
	1	2	3	1	2	3	
Remember	10	10	10	-	-	-	10
Understand	10	10	10	-	-	-	10
Apply	80	80	80	100	100	100	80
Analyse							
Evaluate							
Create							

Assessment Pattern: Psychomotor

Psychomotor Skill	Assignment
Perception	-
Set	-
Guided Response	50
Mechanism	50
Complex Overt Responses	-
Adaptation	-
Origination	-

Sample Questions for Course Outcome Assessment**

Course Outcome 1 (CO1):

1. Define the term characteristic strength of materials.
2. Explain the differences between working stress method and limit state method.
3. Explain the stress-strain behavior of steel and find the stress and strain at various stress levels for Fe415 and Fe500 grade steels.

Course Outcome 2 (CO2):

1. What is the minimum reinforcement requirement for beam as per IS 456:2000
2. Compute the reinforcement required for the rectangular section of size 230mm x 500mm effective subjected to a factored moment of 250 kNm. The materials used in the design are M25 and Fe500. Assume $d_1=35\text{mm}$. Draw the cross section and longitudinal section of the beam showing reinforcement details.
3. Compute the reinforcement required for a two way slab simply supported on all the four sides with provision of torsion reinforcement at corners. The clear dimension of the room is 4m x 4m. It is supported on 230mm thick wall. Live load on slab is 3 kN/m². Use M20 and Fe415 as materials. Draw the longitudinal section of the slab showing reinforcement details.

Course Outcome 3 (CO3):

1. What is the expression related to beam subjected to combined bending, shear and torsion?
2. Compute the shear reinforcement required for a T-beam having breadth of web as 230mm and effective depth of 500mm subjected to an UDL of 30kN/m. The effective length of beam is 7m. The tension reinforcement is 5 Nos of 16mm diameter bar. Use M20 and Fe415 as materials. Draw the cross section and longitudinal section of the beam showing reinforcement details.
3. Compute the reinforcement required for a rectangular beam circular in plan of size 350mm x 550mm subjected to a bending moment of 140kNm, twisting moment of 18kNm and a shear force of 90kN under ultimate condition. Use M25 grade concrete and Fe415 as materials. Draw the cross section and longitudinal section of the beam showing reinforcement details.

Course Outcome 4 (CO4):

1. What is the reason for limiting maximum of 4% reinforcement in columns?
2. Make use of limit state method, design a short circular column 6m long to carry a load of 750kN if both ends of the column are fully restrained, using (i) lateral ties and (ii) helical steel. Draw the cross section and longitudinal section of the column showing reinforcement details.
3. Make use of limit state method, design a column to carry an axial factored load of 2000kN and a factored moment of 50kNm on both the axes. Assume concrete M20 and steel Fe415. Draw the cross section and longitudinal section of the column showing reinforcement details.

Course Outcome 5 (CO5):

1. What is the IS codal provision for the control of deflection for elements?
2. What is the IS codal equation for determining surface crack width?
3. A simply supported L-beam 5m span has effective flange width of 900mm, thickness of flange as 100mm, breadth of web as 250mm and effective depth as 450mm. there are 4 bars of 22mm in tension and 3 bars of 18mm in compression. Experiment the beam for deflection. Assume M20 grade concrete and Fe415 grade reinforcement.

Course Outcome 6 (CO6):

1. What is the IS codal provision for nominal reinforcement required for footing?
2. Compute the shear force and bending moment for a rectangular combined footing connecting two axially loaded columns of size 230mm x 230mm and 300mm x 300mm spaced at 2.90m carrying load of 650kN and 750kN under service state respectively. The safe bearing capacity of soil is 200 kN/m². Use M20 and Fe415 as materials.
3. Make use of limit state method, design an axially loaded square footing of uniform thickness for a column of size 300mm x 300mm carrying a load of 500kN under working stress condition. The allowable bearing capacity of soil is considered as 230kN/m².

Materials: M20 & Fe415. Draw the plan and cross section of the footing showing reinforcement details.

Concept Map

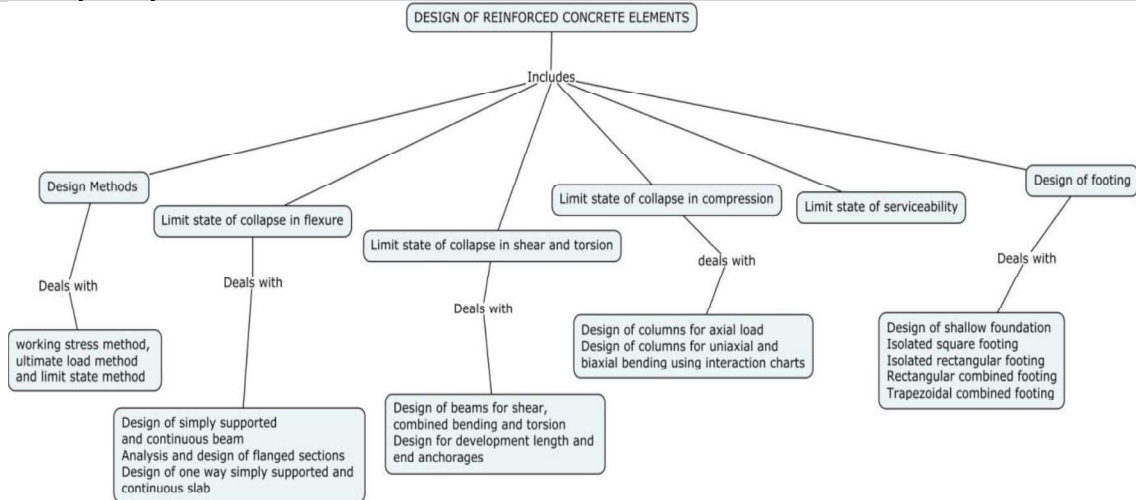

Syllabus

Design Methods: concept of working stress method, ultimate load method and limit state method; Limit state philosophy as detailed in IS code - characteristic strength and design strength of materials, characteristic loads and design loads, partial safety factors for loads and material strength, cover for durability and fire resistance. **Limit state of collapse in flexure:** assumptions, stress-strain curves for concrete and steel, stress block, maximum strain in concrete, limiting values of neutral axis for different grades of steel, balanced and under reinforced sections; Analysis and design of singly and doubly reinforced rectangular and flanges sections - simply supported and continuous beams; Design of one way and two way slabs – simply supported, continuous and restrained using coefficients in IS code; Reinforcement detailing. **Limit state of collapse in shear and torsion:** design of beams for shear, combined bending and torsion; Design for development length and end anchorages; Reinforcement detailing. **Limit state of collapse in compression:** design of columns for axial load – square, rectangular and circular cross sections with lateral and spiral ties; Design of columns for uniaxial and biaxial eccentricities using interaction charts; Reinforcement detailing. **Limit state of serviceability:** serviceability requirements for RC elements; Introduction to working stress method; Deflection calculations using IS code coefficients, short term and long term deflection, crack width calculations. **Design of footing:** shallow foundation - isolated footing – square and rectangular; Combined footing – rectangular and trapezoidal; Reinforcement detailing.

Learning Resources

1. N. Subramanian, Design of Reinforced Concrete Structures, Oxford University Press, New Delhi, 2014.
2. Unnikrishna Pillai and Devdas Menon, Reinforced Concrete Design (Third Edition), Tata Mc Graw Hill Publishing Company Ltd., New Delhi, 2017.
3. P.C. Varghese, Limit State Design of Reinforced Concrete, Prentice Hall of India, Pvt. Ltd., New Delhi, 2008.

4. M.L. Gambhir, Fundamentals of Reinforced Concrete Design, Prentice Hall of India Private Limited, New Delhi, 2006.
5. N. Krishna Raju and R.N. Pranesh, Reinforced Concrete Design IS 456-2000, Principles and practice, New Age International (P) Ltd Publishers, New Delhi, 2015.
6. S.N. Sinha, Reinforced Concrete Design, Tata McGraw-Hill, New Delhi, 2014.
7. Edward G. Nawy, Reinforced Concrete – A fundamental Approach, 6th Edition, Prentice Hall, 2008.
8. Self learning materials – Online courses - <http://www.nptel.iitm.ac.in/>

IS Codes

1. IS 456:2000 Plain and Reinforced Concrete – Code of Practice.
2. IS 875(1-2):1987 Code of Practice for Design Loads (Other than Earthquake) for Buildings and Structures.
3. IS 875(3):2015 Code of Practice for Design Loads (Other than Earthquake) for Buildings and Structures
4. IS 875(4-5):1987 Code of Practice for Design Loads (Other than Earthquake) for Buildings and Structures
5. SP 16:1980 Design Aids for Reinforced Concrete to IS 456:1978.
6. SP 34:1987 Handbook of concrete reinforcement and detailing.
7. Handbook for Limit State Design of Reinforced Concrete Structures – Roorkee.

Course Contents and Lecture Schedule – Theory Part

Module No.	Topics	No. of Lectures	Course Outcome
1.0	Design Methods		
1.1	Concept of working stress method, ultimate load method and limit state method	1	CO1
1.2	Limit state philosophy as detailed in IS code, Characteristic strength and design strength of materials, characteristic loads and design loads	1	CO1
1.3	Partial safety factors for loads and material strength, cover for durability and fire resistance	1	CO1
2.0	Limit state of collapse in flexure		
2.1	Assumptions, stress-strain curves for concrete and steel, stress block, maximum strain in concrete	1	CO1
2.2	Limiting values of neutral axis for different grades of steel - balanced and under reinforced sections	1	CO1
2.3	Analysis of singly and doubly reinforced rectangular sections	2	CO2
2.4	Design of simply supported and continuous beam	1	CO2
2.5	Analysis and design of flanged sections	2	CO2
2.6	Design of one way simply supported and continuous slab	1	CO2
2.7	Design of two way simply supported, continuous and restrained slab using coefficients in IS code	2	CO2
3.0	Limit state of collapse in shear and torsion		
3.1	Design of beams for shear, combined bending and torsion	1	CO3

3.2	Design for development length and end anchorages	1	CO3
4.0	Limit state of collapse in compression		
4.1	Design of columns for axial load – square, rectangular and circular cross sections with lateral and spiral ties	1	CO4
4.2	Design of columns for uniaxial and biaxial bending using interaction charts	2	CO4
5.0	Limit state of serviceability		
5.1	Deflection calculations using IS code coefficients – short term and long term deflection	1	CO5
5.2	Crack width calculations	1	CO5
6.0	Design of footing		
6.1	Design of shallow foundation – Isolated square footing	1	CO6
6.2	Isolated rectangular footing	1	CO6
6.3	Rectangular combined footing	1	CO6
6.4	Trapezoidal combined footing	1	CO6
	TOTAL	24	

List of Exercises for Practical Part

Ex. No	Exercise	No of Practical hours	Course Outcome
1	Design and reinforcement detailing of simply supported beams	2	CO2
2	Design and reinforcement detailing of continuous beams	2	CO2
3	Design and reinforcement detailing of flanged beam	2	CO2
4	Design and reinforcement detailing of one way simply supported and continuous slabs	2	CO2
5	Design and reinforcement detailing of two way simply supported and continuous and restrained slabs	2	CO2
6	Design of beams for shear, combined bending and torsion and its reinforcement detailing	2	CO3
7	Design of columns under axial load – square, rectangular and circular cross sections with lateral and spiral ties and its reinforcement detailing	2	CO4
8	Design of columns under uniaxial and biaxial bending using interaction charts and its reinforcement detailing	2	CO4
9	Design and reinforcement detailing of isolated square footing	2	CO6
10	Design and reinforcement detailing of isolated rectangular footing	2	CO6
11	Design and reinforcement detailing of rectangular combined footing	2	CO6
12	Design and reinforcement detailing of trapezoidal combined footing	2	CO6
	Total	24	

Course Designers:

1. Dr. M.C.Sundarraja mcsciv@tce.edu
2. R. Sankaranarayanan rsciv@tce.edu

18CE670	SOIL AND HIGHWAY ENGINEERING LAB				
	Category	L	T	P	Credit
	PC	0	0	2	1

Preamble

This laboratory course is intended to give hands-on training to determine various index and engineering properties of soil, compaction characteristics, predict the properties of aggregates and subgrade material. With these properties students will be able to identify, classify and appreciate the use of soil and aggregates as suitable construction materials, design appropriate foundations and pavements.

Prerequisite

18CE520

Course Outcomes

On the successful completion of the course students will be able to

CO Number	Course Outcome Statement	Weightage*** in %
CO1	Conduct tests to determine index properties of soil such as Moisture Content, Specific Gravity and Atterberg's Limits	20
CO2	Conduct tests to determine Field Density and Particle Size Distribution of soil	15
CO3	Determine the Coefficient of Permeability of soil	15
CO4	Estimate the Shear Strength parameters of Cohesionless and Cohesive soils	15
CO5	Predict the Compaction Characteristics of soil and evaluate the Strength of Sub Grade material	15
CO6	Perform tests for accessing the suitability of Aggregates in Highway and Railway works	20

*** Weightage depends on Bloom's Level, number of contact hours,

CO Mapping with CDIO Curriculum Framework

CO #	TCE Proficiency Scale	Learning Domain Level			CDIO Curricular Components (X.Y.Z)
		Cognitive	Affective	Psychomotor	
CO1	TPS3	Apply	Value	Mechanism	1.1.1,1.1.2,1.2,2.1.1,2.1.3,2.1.5,2.4.2, 2.4.6,3.2.3,3.2.6,4.1.1,4.1.2
CO2	TPS3	Apply	Value	Mechanism	1.1,1.1.2,1.2,2.1.1,2.1.3,2.1.5,2.4.2, 2.4.6,3.2.3,3.2.6,4.1.1,4.1.2
CO3	TPS3	Apply	Value	Mechanism	1.1.1,1.1.2,1.2,2.1.1,2.1.3,2.1.5,2.4.2, 2.4.6,3.2.3,3.2.6,4.1.1,4.1.2

CO4	TPS3	Apply	Value	Mechanism	1.1.1,1.1.2,1.2,2.1.1,2.1.3,2.1.5,2.4.2,2.4.6,3.2.3,3.2.6,4.1.1,4.1.2
CO5	TPS3	Apply	Value	Mechanism	1.1.1,1.1.2,1.2,2.1.1,2.1.3,2.1.5,2.4.2,2.4.6,3.2.3,3.2.6,4.1.1,4.1.2
CO6	TPS3	Apply	Value	Mechanism	1.1.1,1.1.2,1.2,2.1.1,2.1.3,2.1.5,2.4.2,2.4.6,3.2.3,3.2.6,4.1.1,4.1.2

Mapping with Programme Outcomes and Programme Specific Outcomes

Cos	PO1	PO2	PO3	PO4	PO5	PO6	PO7	PO8	PO9	PO10	PO11	PO12	PSO1	PSO2
CO 1	S	M	L	-	L	M	-	S	L	L	-	L	M	L
CO 2	S	M	L	-	L	M	L	S	L	M	-	L	M	L
CO 3	S	M	L	-	L	M	L	S	L	M	-	M	M	L
CO 4	S	M	L	-	L	M	L	S	L	M	-	M	M	L
CO 5	S	M	L	-	L	M	L	S	L	M	-	M	M	L
CO 6	S	M	L	-	L	M	L	S	L	M	-	M	M	L

S- Strong; M-Medium; L-Low

Assessment Pattern: Cognitive Domain

Cognitive Levels	Model Examination	Terminal Examination
Remember	--	--
Understand	--	--
Apply	100	100
Analyse	--	--
Evaluate	--	--
Create	--	--

Assessment Pattern: Psychomotor

Psychomotor Skill	Mini project/Practical Component/Observation
Perception	--
Set	--
Guided Response	20
Mechanism	80
Complex Overt Responses	--
Adaptation	--
Origination	--

List of Experiments/Activities with CO Mapping

- Determination of Specific Gravity of soil using Pycnometer.
 - Determination of Water Absorption and Specific Gravity of Aggregates (size > 40 mm).
 - Determination of Penetration value of Bitumen.
- Determination of Moisture Content of soil by Oven Drying method
 - Determination of Shrinkage Factors of soil.
 - Determination of Softening Point of Bitumen.
- Determination of Liquid and Plastic Limits of soil.

4. Grain size Distribution Analysis for soil.
5. Determination of Field Density of soil by sand Replacement Method.
6. Determination of Coefficient of Permeability of soil by Constant Head Permeability Test.
7. Determination of Coefficient of Permeability of soil by Variable Head Permeability Test.
8. Determination of Shear Strength parameters of soil by Direct Shear Test.
9. Determination of Unconfined Compressive Strength of clay.
10. Determination of Dry Density - Moisture Content relation using Light Compaction (Standard Proctor Compaction Test).
11. Determination of California Bearing Ratio value of subgrade soil.
12. (a) Determination of Impact Value of aggregates.
(b) Determination of Flakiness and Elongation Indices of aggregates.
13. Determination of Consolidation Properties of soil.

Demonstration Experiments:

14. Grain Size Distribution - Hydrometer Analysis
15. Determination of Los Angeles Abrasion value of aggregates.

Learning Resources

1. "Soil and Roads Lab Manual", Department of Civil Engineering, TCE.
2. Dr. Arora, K. R., "Soil Mechanics and Foundation Engineering", Standard Publishers Distributors, New Delhi, 2015.
3. S.K Khanna, and C E G. Justo and A. Veeraragavan, "Highway Engineering", New Chand and Bros, Roorkee, 10th edition, 2015.

IS Code of Practice :

- IS: 2720 - Part-2 (1973), "Determination of water content"
- IS: 2720 - Part-3 Sect. 1 -1980, "Determination of Specific gravity - Fine- grained soils".
- IS: 2720 - Part-3 Sect. 2 -1981, "Determination of Specific gravity - Fine, Medium, and coarse - grained soils".
- IS: 2720 - Part 4 -1975, "Grain size analysis".
- IS: 2720 - Part 5-1970, "Determination of Liquid and Plastic Limits".
- IS: 2720 - Part 6 -1972, "Determination of Shrinkage Factors".
- IS: 2720 - Part 7 -1983, "Determination of Water content- Dry density Relation using light compaction".
- IS: 2720 - Part 10 -1973, "Determination of Unconfined Compressive strength".
- IS: 2720 - Part 13 -1972, "Direct Shear Test".
- IS: 2720 - Part 15 -1986, "Determination Consolidation Properties".
- IS: 2720 - Part 28 -1974, "Determination of dry Density of Soil in- place-by the sand-replacement method".
- IS: 2720 - Part 36 -1975, "Laboratory Determination of Permeability of Granular soils (Constant Head)".
- IS:2386 Part 1- 1963, "Methods of Test for Aggregates for Concrete"(Part I -Particle Size And Shape)

- IS: 2386 Part 3 -1963,"Methods of Test for Aggregates for Concrete"(Part III-Specific Gravity, Density, Voids, Absorption And Bulking)
- IS:2386 Part 4 -1963,"Methods of Test for Aggregates for Concrete"(Part IV-Mechanical Properties)
- IS-1203 -1978 "Methods for testing of Tar" -"Penetration Value of Bitumen"

Course Designers

1. Dr. R, Sanjay Kumar sanjaykumar@tce.edu
2. Dr. R. Velkennedy rvkciv@tce.edu

18CE710	IRRIGATION AND WATER RESOURCES ENGINEERING				
	Category	L	T	P	Credit
	PC	3	0	0	3

Preamble

This subject deals with study of water resources potential and various irrigation methods practiced in our country and also to understand an irrigation systems and its components.

Prerequisite**Course Outcomes**

On the successful completion of the course students will be able to

CO Number	Course Outcome Statement	Weightage*** in %
CO1	Outline the importance and status of water resources potential of our country and water policy.	10
CO2	Illustrate the different types and methods of irrigation practices.	20
CO3	Compute the storage capacity of reservoir for a given demand.	10
CO4	List and compute the forces acting on dam and illustrate its failures and remedial measures.	20
CO5	Sequence the functions of different irrigation structures in an irrigation system.	30
CO6	Describe the components of tank irrigation and the concept of irrigation management transfer.	10

*** Weightage depends on Bloom's Level, number of contact hours,

CO Mapping with CDIO Curriculum Framework

CO #	TCE Proficiency Scale	Learning Domain Level			CDIO Curricular Components (X.Y.Z)
		Cognitive	Affective	Psychomotor	
CO1	TPS2	Understand	Respond	Guided Response	1.1.1, 1.2,
CO2	TPS3	Apply	Value	Mechanism	1.1.2, 1.1.3, 1.2, 2.3.1,
CO3	TPS3	Apply	Value	Mechanism	1.1.1, 1.2, 2.1.1, 2.1.3, 2.1.5, 2.2.2,
CO4	TPS3	Apply	Value	Mechanism	1.1.1, 1.2, 2.1.1, 2.1.3, 2.1.5,
CO5	TPS3	Apply	Value	Mechanism	1.1.1, 1.2, 2.1.1, 2.1.3, 2.1.5,
CO6	TPS2	Understand	Respond	Guided Response	1.1.1, 1.2,

Mapping with Programme Outcomes and Programme Specific Outcomes

Cos	PO1	PO2	PO3	PO4	PO5	PO6	PO7	PO8	PO9	PO10	PO11	PO12	PSO1	PSO2
CO1	M	L	-	-	-	M	-	-	-	-	-	-	L	-
CO2	S	M	L	-	-	M	L	-	L	L	-	-	L	L
CO3	S	M	L	-	-	M	L	-	L	L	-	-	L	L
CO4	S	M	L	-	-	M	L	-	-	-	-	-	L	-
CO5	S	M	L	-	-	M	M	-	L	L	-	-	L	L
CO6	M	L	-	-	-	M	-	-	-	-	-	-	L	-

S- Strong; M-Medium; L-Low

Assessment Pattern: Cognitive Domain							
Cognitive Levels	Continuous Assessment Tests			Assignment			Terminal Examination
	1	2	3	1	2	3	
Remember	20	20	20	--	--	--	20
Understand	40	20	20	--	--	--	20
Apply	40	60	60	100	100	100	60
Analyse	--	--	--	--	--	--	--
Evaluate	--	--	--	--	--	--	--
Create	--	--	--	--	--	--	--

Assessment Pattern: Psychomotor	
Psychomotor Skill	Mini project /Assignment/Practical Component
Perception	--
Set	--
Guided Response	40
Mechanism	60
Complex Overt Responses	--
Adaptation	--
Origination	--

Sample Questions for Course Outcome Assessment**

** (2 to 3 at the cognitive level of course outcome)

Course Outcome1(CO1):

1. What is the present state of water resources potential of India and Tamilnadu?
2. What are the objectives of water resources development projects?
3. Mention the importance of National water policy and discuss the salient points in detail.

Course Outcome2(CO2):

1. You are requested to propose suitable surface irrigation methods for different types of soil and crops. Discuss the various surface irrigation methods practiced in India.
2. Write about the importance of Soil water plant relationship using a sketch.
3. To increase the irrigation efficiencies, what are the various irrigation efficiencies used in irrigation network, explain.

Course Outcome3(CO3):

1. As a Civil Engineer, you are assigned to select a site for the reservoir. Discuss the important criteria for site selection.
2. You are entrusted to fix the capacity of a multipurpose reservoir, explain the procedure to fix the reservoir capacity using mass curve analysis.
3. Propose pre and post construction measures to reduce the sediment inflow into the reservoir.

Course Outcome 4 (CO4):

1. Classify dams with suitable examples.
2. Identify and discuss the various forces acting on gravity dam. What are the forces taken into account for extreme load combination?
3. What are the causes of failure of earthen dam and suggest suitable remedies?

Course Outcome 5 (CO5):

1. As a Civil Engineer, suggest the important components constructed to divert the water from river to new canal. Draw the layout of such diversion head work system and explain all the components in detail.

2. A drainage and a canal crosses each other as per the condition given below, suggest and explain the suitable cross drainage works for such situation.
 - (i) Canal passes over the drain, (ii) Drain passes over the canal and (iii) Canal and drain crosses at the same level.
3. Design an irrigation channel carries discharge of 50 cumecs, also determine the longitudinal slope. Take Lacey's silt factor=1.0, side slope = 1/2 :1.

Course Outcome6(CO6):

1. Write the need and necessity for irrigation management transfer
2. Describe the various software in irrigation water resources management.
3. Discuss the components of tank irrigation system.

Concept Map

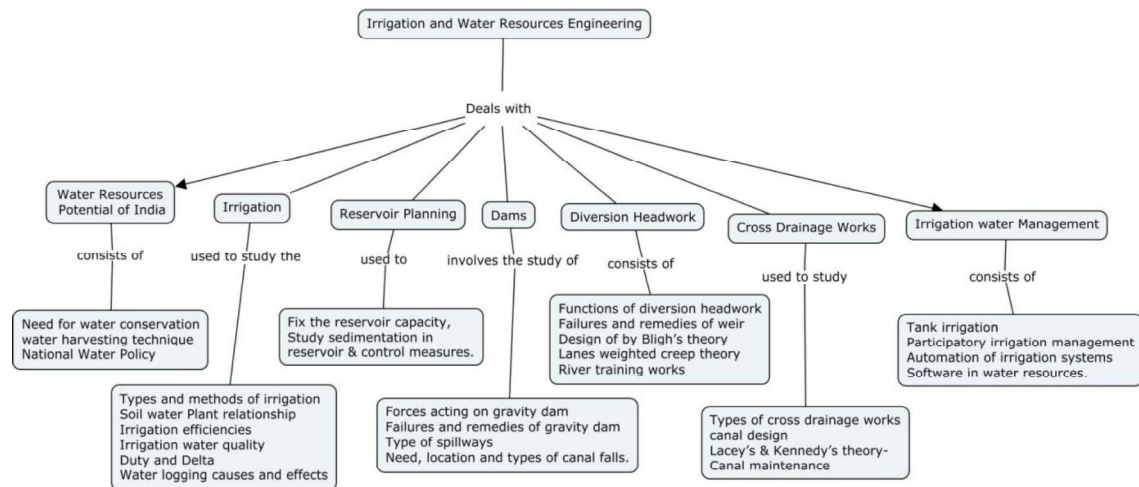

Syllabus

Importance of water resources: Hydrological cycle and its importance-Status of water resource potential of India and Tamilnadu-Requirement of water for various uses - Need for water conservation-Water harvesting techniques-National water policy-Benefits of linking of rivers.**Irrigation:** Need for irrigation-Advantages and ill effects of irrigation-Types and methods of irrigation-Lift and rain fed irrigation-Relationship between soil, water and plant-Irrigation efficiencies-Irrigation water quality-Duty and Delta-Water logging, causes and effects.**Reservoir planning:** Site selection for reservoir-Classification of reservoirs-Determination of storage capacity-Reservoir sedimentation-Methods of controlling the sedimentation. **Dams:** Classifications of dams-Forces acting on gravity dam-Failures and remedies of gravity dam-Elementary and practical profile of gravity dam-Type of spillways-Need, location and types of canal falls. **Diversion headwork and cross drainage works:** Components and functions of diversion headwork-Types, failures and remedies of weir-Design of impervious floor of weir by Bligh's theory and Lane's weighted creep theory-River training works-Types of cross drainage works-Design of canal by Lacey's theory and Kennedy's theory-Canal lining and canal maintenance. **Irrigation water management:** Tank irrigation-Components of tank irrigation-Participatory irrigation management-Water user association-Automation of irrigation systems-Software in water resources.

Learning Resources

1. Santhosh Kumar Garg, "Irrigation Engineering and Hydraulic Structures" Khanna Publishres-New Delhi. 2012
2. Punmia, B.C and Pande B.B Lal, "Irrigation and Water Power Engineering", Lakshmi Publications (P) Ltd, New Delhi. 2016
3. Sharma R.K and Sharma T.K' "Irrigation Engineering (Including Hydrology)", S.Chand & Co Ltd, New Delhi. 2014

4. Dilip Kumar Mujumdar, "Irrigation Water Management-Principles & Practice", Prantice Hall of India (P) Ltd, New Delhi. 2014
5. P.N.Modi, "Irrigation Water Resources and Water Power Engineering" Standard Book House, New Delhi, 2014
6. National Water Policy 2012, MOWR,GOI
7. <https://nptel.ac.in/courses/105105110/>

Course Contents and Lecture Schedule			
Module No.	Topic	No. of Hours	Course Outcome
1.	Importance of Water Resources		CO1
1.1	Hydrological cycle and its importance.	1	
1.2	Status of water resources in India and Tamilnadu.	1	
1.3	Requirement of water for various uses-Needs for water conservation, water harvesting techniques.	1	
1.4	Salient points of National Water Policy and linking of rivers	1	
2.	Irrigation		CO2
2.1	Need for irrigation, advantages and ill effects of irrigation.	1	
2.2	Types and methods of irrigation, lift and rain fed irrigation, modern irrigation practices.	2	
2.3	Soil Water Plant relationship.	1	
2.4	Irrigation efficiencies, Irrigation water quality.	1	
2.5	Duty and Delta, methods of improving duty.	1	
2.6	Water logging, causes and effects.	1	
3.	Reservoir Planning		CO3
3.1	Classification of reservoirs, Surveys conducted, Site selection for reservoir	1	
3.2	Storage zones, determination of Storage capacity of reservoir	2	
3.3	Reservoir sedimentation, methods of controlling the sedimentation,	1	
4.	Dams		CO4
4.1	Classifications of dams, selection of dams.	1	
4.2	Forces acting on gravity dam.	2	
4.3	Failures and remedies of gravity dam.	1	
4.4	Elementary and practical profile of gravity dam, Drainage galleries in dams.	2	
4.5	Types of spillways.	1	
4.6	Need, location and types of canal falls.	1	
5.	Diversion Headwork and Cross drainage works		CO5
5.1	Components of diversion headwork and its functions	2	
5.2	Types, failures and remedies of weir	1	
5.3	Design of impervious floor of weir by Bligh's theory and Lanes weighted creep theory.	2	
5.4	River training works.	1	
5.5	Functions of Aqueduct, Syphon aqueduct, Level crossing, inlet and outlet, Canal outlets.	1	
5.6	Design of canal by Lacey's theory and Kennedy's theory.	2	
5.7	Canal lining and Canal maintenance.	1	
6.	Irrigation Water Management		CO6
6.1	Tank irrigation-Components of tank irrigation.	1	
6.2	Participatory irrigation management, water user association.	1	
6.3	Automation and sensors in irrigation systems-Software in water resources.	1	

	Total hours	36	
--	--------------------	-----------	--

Course Designers:

1. Dr. T. Baskaran tbciv@tce.edu
2. Dr. S. Chandran schandran@tce.edu

18CE720	CONSTRUCTION MANAGEMENT				
	Category	L	T	P	Credit
	PE	2	0	0	2

Preamble

This course imparts knowledge on Construction Management principles needed for execution of projects effectively and efficiently

Prerequisite

Nil

Course Outcomes

On the successful completion of the course students will be able to

CO Number	Course Outcome Statement	Weightage*** in %
CO1	Enumerate the objectives and principles of construction management	15
CO2	Discuss the components involved in planning of resources for construction projects	10
CO3	Enumerate tendering and contractual procedure and systems of execution of construction works	25
CO4	Explain the process involved in measurement of construction works and preparation of accounts	10
CO5	Specify the process involved in maintenance and management of stores in construction projects	10
CO6	Apply the concept of network techniques in analyzing projects	30

*** Weightage depends on Bloom's Level, number of contact hours,

CO Mapping with CDIO Curriculum Framework

CO #	TCE Proficiency Scale	Learning Domain Level			CDIO Curricular Components (X.Y.Z)
		Cognitive	Affective	Psychomotor	
CO1	TPS2	Understand	Respond	Guided Response	1.2,2.1.1,2.3.1,2.3.3,2.4.3,2.4.4 2.5.1,2.5.4,3.1.1,3.1.4,3.2.3, 3.2.6,4.1.1,4.1.2,4.1.5,4.2.4, 4.3.1,4.3.4
CO2	TPS3	Apply	Value	Mechanism	1.2,2.1.1,2.3.1,2.3.3,2.4.3,2.4.4 2.5.1,2.5.4,3.1.1,3.1.4,3.2.3, 3.2.6,4.1.1,4.1.2,4.1.5,4.2.4, 4.3.1,4.3.4,4.5.1,4.6.6
CO3	TPS3	Apply	Value	Mechanism	1.2,2.1.1,2.3.1,2.3.3,2.4.3,2.4.4 2.5.1,2.5.4,3.1.1,3.1.4,3.2.3, 3.2.6,4.1.1,4.1.2,4.1.5,4.2.4,

					4.3.1,4.3.4,4.5.1,4.6.6
CO4	TPS3	Apply	Value	Mechanism	1.1.1,1.2.2.1.1,2.3.1,2.3.3,2.4.3,2.4.4, 2.5.1,2.5.4,3.1.1,3.1.4, 3.2.3,3.2.6,4.1.1,4.1.2,4.1.5, 4.2.4, 4.3.1,4.3.4,4.5.1,4.6.6
CO5	TPS2	Understand	Respond	Guided Response	1.1.1,1.2.2.1.1,2.3.1,2.3.3,2.4.3,2.4.4, 2.5.1,2.5.4,3.1.1,3.1.4, 3.2.3,3.2.6,4.1.1,4.1.2,4.1.5, 4.2.4, 4.3.1,4.3.4,4.5.1,4.6.3,4.6.6
CO6	TPS3	Apply	Value	Mechanism	1.1.1,1.2.2.1.1,2.3.1,2.3.3,2.4.3,2.4.4, 2.5.1,2.5.4,3.1.1,3.1.4, 3.2.3,3.2.6,4.1.1,4.1.2,4.1.5,4.2.4, 4.3.1,4.3.4,4.5.1,4.6.3

Mapping with Programme Outcomes and Programme Specific Outcomes

Cos	PO1	PO2	PO3	PO4	PO5	PO6	PO7	PO8	PO9	PO10	PO11	PO12	PSO1	PSO2
CO1.	M	L	-	-	M	-	L	M	M	S	M	-	L	M
CO2.	S	M	L	-	S	L	M	S	S	S	S	L	M	S
CO3.	S	M	L	-	S	L	M	S	S	S	S	L	M	S
CO4.	S	M	L	-	S	L	M	S	S	S	S	L	M	S
CO5.	M	L	-	-	M	-	L	M	M	S	M	-	L	M
CO6	S	M	L	-	S	L	M	S	S	S	S	L	M	S

S- Strong; M-Medium; L-Low

Assessment Pattern: Cognitive Domain

Cognitive Levels	Continuous Assessment Tests			Assignment			Terminal Examination
	1	2	3	1	2	3	
Remember				-	-	-	
Understand	30	-	25	-	-	-	20
Apply	70	100	75	10	10	10	80
Analyse							
Evaluate							
Create							

Assessment Pattern: Psychomotor

Psychomotor Skill	Miniproject /Assignment/Practical Component
Perception	-
Set	-
Guided Response	-
Mechanism	100
Complex Overt Responses	-
Adaptation	-
Origination	-

Sample Questions for Course Outcome Assessment**

Course Outcome 1(CO1):

1. Write the need and importance of managing projects in construction sector
2. Discuss the stages involved in execution of projects

3. As a project manager of a construction industry identify and discuss the functions you would exercise for successful completion of projects

Course Outcome 2(CO2):

1. Define construction planning and mention its need in projects
2. A dam construction project is proposed to be constructed. Identify and discuss the factors you would consider for selection of a suitable site of project
3. As a project manager, mention on what basis you will decide upon the purchase of materials for your project with suitable reasoning

Course Outcome 3(CO3):

1. Define the terms tender and contract
2. Differentiate between unit price and cost plus % contracts with applicability of each.
3. Due to heavy rains in a hilly terrain, landslide has occurred which needs to be cleared shortly. Identify the mode of execution of work you would resort to with suitable reasons

Course Outcome 4(CO4):

1. Enumerate the various types of measurement of works
2. Identify a suitable type of measurement for the following works: Water Bound Macadam road, brick work and steel reinforcement fabrication
3. List the types of bills used for payment of works done

Course Outcome 5(CO5):

1. List the classification of stores
2. Discuss the procedure for physical verification of stores
3. Identify the various discrepancies found during stock verification and suggest process of correcting it

Course Outcome 6(CO6):

1. A project consists of 12 activities. The time required for each activity is given in the table below. Use the following logical relationships; draw a network diagram for the project and determine the critical path and duration required for completion of the project.
 - Activity A,D and H can be performed concurrently and represent the start of the project
 - B succeeds A; C and G follow H; D,C and B precede F; L follows A; M comes after G
 - K is preceded by L; X cannot start until K, F and M are completed
 - Z succeeds G; X and Z are last operations

Activity	A	B	C	D	F	G	H	K	L	M	X	Z
Duration (days)	4	6	4	4	6	3	3	4	8	3	2	2

2. Write the meaning of bar charts? Discuss its limitations and methods to overcome it
3. Conduct CPM analysis for the project using the given data and determine:
 - i) ES, EF, LS & LF for the activities
 - ii) Critical path and critical activities
 - iii) Total and free floats for the activities
 - iv) Draw the square network

Act (i-j)	1-2	1-3	2-5	2-7	3-4	3-6	4-5	5-6	5-7	6-7	7-8
Duration (days)	20	24	16	24	12	10	16	16	20	12	14

Concept Map

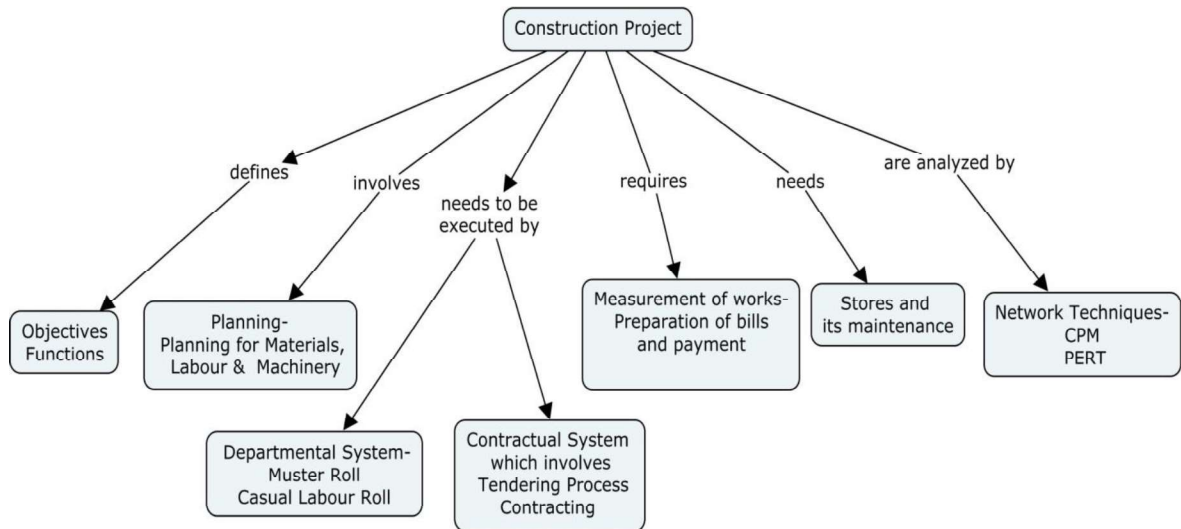

Syllabus

Construction Management – General Principles – need, objectives & functions, Classification & stages involved in construction projects — Construction team—Preliminary planning of a scheme – Construction planning. **Tendering and contractual procedures** - definition of tender and contract. Deposits – Earnest Money Deposit and Security Deposit – legal implications — Penalties and Arbitration- Execution of works: Methods - Departmental labour- Muster Roll system and Casual Labour system.EPC and other forms of contracts. **Measurement of Works** – M-book, Types of measurements – original, pre and check measurement. Maintenance of Accounts —Types of bills and payment – completion reports and completion certificates. **Stores:** Classification and Codification systems - inspection and maintenance – Stock verification procedures. **Analysis of projects:** Work Breakdown Structure – Fulkerson’s rules for drawing networks -network analysis – CPM and PERT- concepts and procedure.

Learning Resources

1. S. Sangareddi and P.L. Meiyappan, “Construction Management”, Kumaran Publications, Coimbatore, 2000
2. B.C. Punmia and K.K. Khandelwal, “Project Planning and Control with PERT/CPM”, Laxmi publications, New Delhi, 2000
3. B.L. Gupta and Amit Gupta, “Construction Planning and Accounts”, Standard Publishers Distributors, Delhi, 1997
4. P.S. Gahlot and B.M. Dhir, “Construction Planning and Management”, New Age International Limited, Publishers, 1996
5. V.N. Vazirani and S.P. Chandola, “Construction Management and Accounts”, Khanna Publishers, New Delhi, 1986
6. <https://online.hbs.edu/courses/management-essentials/>
7. <https://www.coursera.org/specializations/construction-management>
8. <https://www.udemy.com/>

Course Contents and Lecture Schedule

Module No.	Topic	No. of Hours	Course Outcome
1.	Construction Management		
1.1	General Principles – need, objectives & functions, Classification and stages involved in construction projects	2	CO1
1.2	Types of construction – Construction team	1	
2.0	Planning of Projects		

2.1	Preliminary planning of a scheme	1	CO2
2.2	Materials, equipments and labour management	1	
3.	Tendering and contractual procedures		
3.1	Definition of tender –Tendering procedure - Tender document	1	CO3
3.2	Definition of contract- legal implications	1	
3.3	Penalties and Arbitration- procedure	1	
3.4	Execution methods: Departmental labour- Muster Roll system and Casual Labour system	1	
3.5	Various forms of contracts-merits and demerits	2	
4	Measurement of Works		
4.1	M-book, Types of measurements – original, pre and check measurements	1	CO4
4.2	Maintenance of Accounts –Types of bills and payment – completion reports and completion certificates	1	
5.0	Stores		
5.1	Definition of stores - Classification and Codification systems	1	CO5
5.2	Inspection and maintenance – Stock verification procedures.	1	
6.0	Analysis of projects		
6.1	Work Breakdown Structure– Concept and problems	1	CO6
6.2	Drawing of Networks	2	
6.3	CPM - concepts and procedure	1	
6.4	Problems in CPM	2	
6.5	PERT- concepts and procedure	1	
6.6	Problems in PERT	2	
		Total Hours	24

Course Designers:

- | | |
|--------------|---------------------------|
| 1. G.Chitra | gcciv@tce.edu |
| 2. S. Kannan | skannanciviltce@gmail.com |

18CE770	ESTIMATION AND COSTING LAB				
	Category	L	T	P	Credit
	PC	1	0	2	2

Preamble

This lab course focuses on students acquiring knowledge on arriving at quantities of items of works for buildings and road projects. It also gives an exposure to rate analysis for different types of works knowing its specifications.

Prerequisite

Fundamentals of Mathematics, Building materials and technology

Course Outcomes

On the successful completion of the course students will be able to:

CO Number	Course Outcome Statement	Weightage in %
CO1	Explain the detailed specifications of various activities in construction works	10
CO2	Estimate quantities of items of works for residential buildings of load bearing type -Individual wall method	16
CO3	Estimate quantities of items of works for residential buildings of load bearing type -Centre line method	16
CO4	Estimate quantities of items of works for residential buildings of framed type	20
CO5	Estimate quantities of earthwork in cutting and embankment for road work	22
CO6	Conduct rate analysis for various activities involved in construction works	16

*** Weightage depends on Bloom's Level, number of contact hours,

CO Mapping with CDIO Curriculum Framework

CO #	TCE Proficiency Scale	Learning Domain Level			CDIO Curricular Components (X.Y.Z)
		Cognitive	Affective	Psychomotor	
CO1	TPS2	Understand	Respond	Guided Response	1.1.1,1.1.3,1.2,3.2.3,3.2.6,3.3.1,4.1.1,4.2.3
CO2	TPS3	Apply	Value	Mechanism	1.1.1,2.1.1,2.1.3,2.1.4,2.1.5,2.5.1,2.5.4,4.1.1
CO3	TPS3	Apply	Value	Mechanism	1.1.1,2.1.1,2.1.3,2.1.4,2.1.5,2.5.1,2.5.4,4.1.1
CO4	TPS3	Apply	Value	Mechanism	1.1.1,2.1.1,2.1.3,2.1.4,2.1.5,2.5.1,2.5.4,4.1.1
CO5	TPS3	Apply	Value	Mechanism	1.1.1,2.1.1,2.1.3,2.1.4,2.1.5,2.5.1,2.5.4,4.1.1
CO6	TPS3	Apply	Value	Mechanism	1.1.1,2.1.1,2.1.3,2.1.4,2.1.5,2.5.1,2.5.4,4.1.1,4.3.4

Mapping with Programme Outcomes and Programme Specific Outcomes

COs	PO1	PO2	PO3	PO4	PO5	PO6	PO7	PO8	PO9	PO10	PO11	PO12	PSO1	PSO2
-----	-----	-----	-----	-----	-----	-----	-----	-----	-----	------	------	------	------	------

CO1.	M	L	-	-	M	-	-	M	M	S	M	-	L	L
CO2.	S	M	L	-	S	L	M	S	S	S	S	L	M	M
CO3.	S	M	L	-	S	L	M	S	S	S	S	L	M	M
CO4.	S	M	L	-	S	L	M	S	S	S	S	L	M	M
CO5.	S	M	L	-	S	L	M	S	S	S	S	L	M	M
CO6.	S	M	L	-	S	L	M	S	S	S	S	L	M	M

S- Strong; M-Medium; L-Low

Assessment Pattern: Cognitive Domain

Cognitive Levels	Model Examination	Terminal Examination
Remember	--	--
Understand	10	10
Apply	90	90
Analyse	--	--
Evaluate	--	--
Create	--	--

Assessment Pattern: Psychomotor

Psychomotor Skill	Miniproject /Practical Component/Observation
Perception	10
Set	--
Guided Response	10
Mechanism	80
Complex Overt Responses	--
Adaptation	--
Origination	--

List of Experiments/Activities with CO Mapping

1. Framing detailed specifications for various activities involved in construction works
2. Preparation of Preliminary estimate of buildings
3. Estimate quantities of items of works for residential buildings of load bearing type using Individual wall method
4. Estimate quantities of items of works for residential buildings of load bearing type using Centre line method
5. Estimate quantities of items of works for residential buildings of framed type
6. Estimate quantities of earthwork in embankment for road work
7. Estimate quantities of earthwork in cutting and embankment for road work
8. Rate analysis – concept and terminologies, CPWD- DSR/ PWD Schedule of rates
9. Arriving at rate per unit of items of plain concrete in different types of foundation, floor and weathering course work
10. Arriving at rate per unit of items of different types of RCC works in structural elements – Beams, Columns, slabs etc.
11. Arriving at rate per unit of items of different types of Masonry works (Stone, Brick etc.), reinforced brick work.
12. Arriving at rate per unit of items of different types of finishing works – plastering, flooring, DPC, pointing, painting etc.

Learning Resources

1. Dutta B.N., "Estimating and Costing in Civil Engineering: Theory and Practice, Including Specifications and Valuation", UBS Publishers' Distributors, 24th edition, 1998.
2. Chakraborti. M, "Estimating, Costing, Specification & Valuation In Civil Engineering, Vikas Book House, Pune, 2006

3. Robert Peurifoy and Gerold Oberlender "Estimating Construction Costs", Kindle Edi, 2011
4. Govt of Tamil Nadu PWD – "Standard Schedule of Rates", 2016-17
5. CPWD –DSR: <https://cpwd.gov.in> > Publication > DSR_Vol_2_2018
6. <https://www.coursera.org/learn/construction-cost-estimating>

Course Designers

1. Dr. G. Chitra gcciv@tce.edu
2. Mr. S. Kannan skannanciviltce@gmail.com

18CEPA0	FINITE ELEMENT ANALYSIS				
	Category	L	T	P	Credit
	PC	3	0	0	3

Preamble

This course provides an introduction to the finite element analysis, from engineering rather than a purely mathematical point of view.

Prerequisite

Nil.

Course Outcomes

On the successful completion of the course, students will be able to

CO Number	Course Outcome Statement	Weightage*** in %
CO1	Execute the potential energy concepts, equations of equilibrium weak and variational formulation	15
CO2	Resolve the stresses and reaction forces in one dimensions	20
CO3	Resolve the stresses and forces in trusses	20
CO4	Resolve two dimensional problems using constant strain triangle Elements	15
CO5	Execute isoparametric formulation for two dimensional problems	15
CO6	Resolve the Gaussian quadrature of one and two dimensional integrals	15

*** Weightage depends on Bloom's Level, number of contact hours,

CO Mapping with CDIO Curriculum Framework

CO #	TCE Proficiency Scale	Learning Domain Level			CDIO Curricular Components (X.Y.Z)
		Cognitive	Affective	Psychomotor	
CO1	TPS3	Apply	Value	Mechanism	1.1.1,1.2.2,2.1.1,2.4.4,3.2.5,4.1.1
CO2	TPS3	Apply	Value	Mechanism	1.1.1,1.2.2,1.3.2,1.3.3,2.1.2,2.1.5,2.4.4,2.4.6,3.2.5,4.1.1,4.3.3,4.5.4
CO3	TPS3	Apply	Value	Mechanism	1.1.1,1.2.2,1.3.2,1.3.3,2.1.2,2.1.5,2.4.4,2.4.6,3.2.5,4.1.1,4.3.3,4.5.4
CO4	TPS3	Apply	Value	Mechanism	1.1.1,1.2.2,1.3.2,1.3.3,2.1.2,2.1.5,2.4.4,2.4.6,3.2.5,4.1.1,4.3.3,4.5.4

CO5	TPS2	Understand	Respond	Guided response	1.1.1,2.1.1,4.3.4,4.4.4
CO6	TPS3	Apply	Value	Mechanism	1.1.1,1.2.2,2.1.1,2.4.4,3.2.5,4.1.1

Mapping with Programme Outcomes and Programme Specific Outcomes

Cos	PO1	PO2	PO3	PO4	PO5	PO6	PO7	PO8	PO9	PO10	PO11	PO12	PSO1	PSO2
CO 1	S	M	L	-	-	-	-	M	M	-	M	L	M	M
CO 2	S	M	L	-	L	-	-	M	M	M	M	S	M	M
CO 3	S	M	L	-	L	-	-	M	M	M	M	S	M	M
CO 4	S	M	L	-	L	-	-	M	M	M	M	S	M	M
CO 5	M	L	-	-	-	-	-	M	M	-	M	M	M	M
CO 6	S	M	L	-	-	-	-	L	M	-	M	L	M	M

S- Strong; M-Medium; L-Low

Assessment Pattern: Cognitive Domain

Cognitive Levels	Continuous Assessment Tests			Assignment			Terminal Examination
	1	2	3	1	2	3	
Remember	10	10	10	-	-	-	10
Understand	20	20	20	-	-	-	20
Apply	70	70	70	100	100	100	70
Analyse							
Evaluate							
Create							

Assessment Pattern: Psychomotor

Psychomotor Skill	Miniproject /Assignment/Practical Component
Perception	-
Set	-
Guided Response	50
Mechanism	50
Complex Overt Responses	-
Adaptation	-
Origination	-

Sample Questions for Course Outcome Assessment**

Course Outcome1(CO1):

1. Explain internal and external forces with examples.
2. Compute the deflection at the centre of a simply supported beam subjected to uniformly distributed load over the entire span, Using Rayleigh Ritz method.
3. Discuss weighted integral and weak formulation with examples.
4. Compute the deflection at the free end of a cantilever beam subjected to uniformly distributed load over the entire span, Using Rayleigh Ritz method.
5. State theorem of minimum potential energy.

Course Outcome2(CO2):

1. Compute the nodal displacement, stresses in each element and reaction forces. ($E=2 \times 10^5 \text{ N/mm}^2$). Axial force $P=20\text{N}$ is applied as shown in Fig.1.

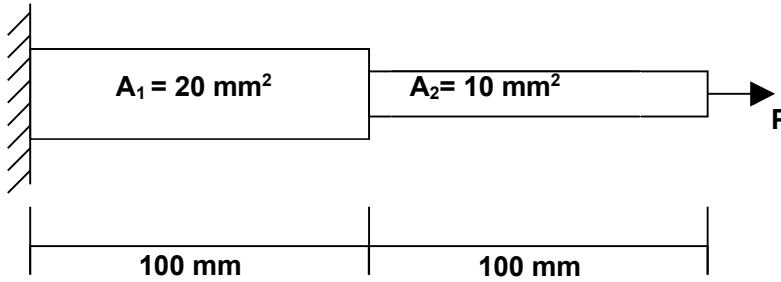
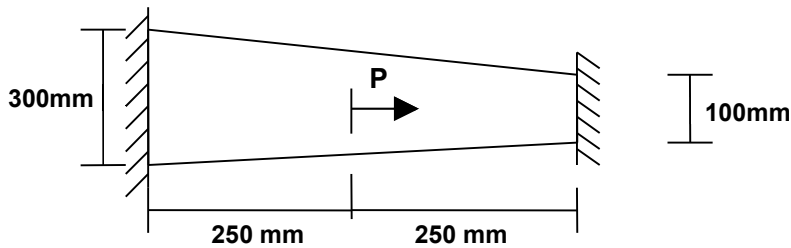

Fig.1

2. Resolve the nodal displacements, element stresses and reaction force for the bar shown in Fig.2 having $P = 30\text{kN}$.



Thickness = 25mm
 $E = 2 \times 10^5 \text{ N/mm}^2$
 $\rho = 78.5 \text{ kN/m}^3$

Fig.2

3. Infer the element stiffness matrix and shape function for one dimensional bar element.

Course Outcome3(CO3):

1. Resolve the forces in the members of the truss shown in Fig.3 by finite element method. Take $E = 200 \text{ GPa}$.

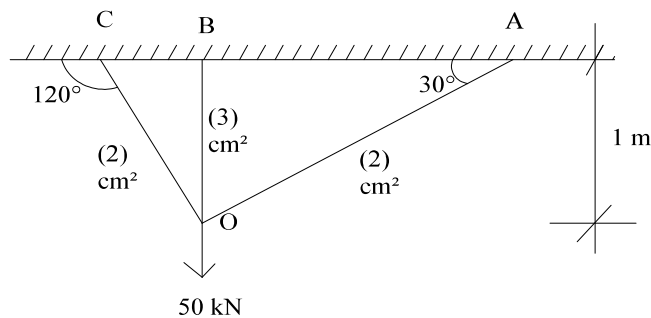

Fig.3

2. Compute the forces in the members of the truss shown in Fig.4 by finite element method. Take $E = 200 \text{ GPa}$.

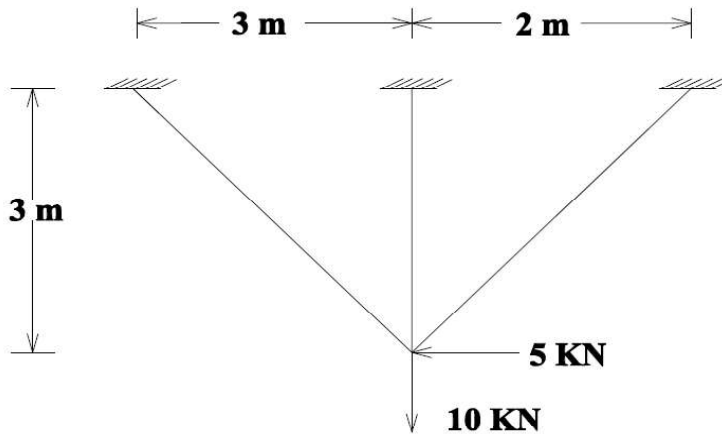

Fig.4

3. Resolve the forces in the members of the truss shown in Fig.5 by finite element method. Take $E = 200 \text{ GPa}$.

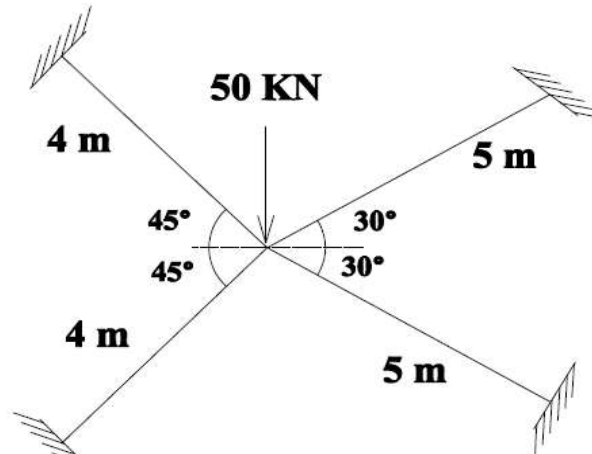

Fig.5

Course Outcome 4 (CO4):

1. Describe plane stress and plane strain problem with examples.
2. Interpret the expression of shape function, strain displacement matrices and stiffness matrix for a CST element .
3. Compute the displacements and stresses for the element shown in Fig.6 using plane stress conditions. Body force may be neglected in comparison with the external forces.

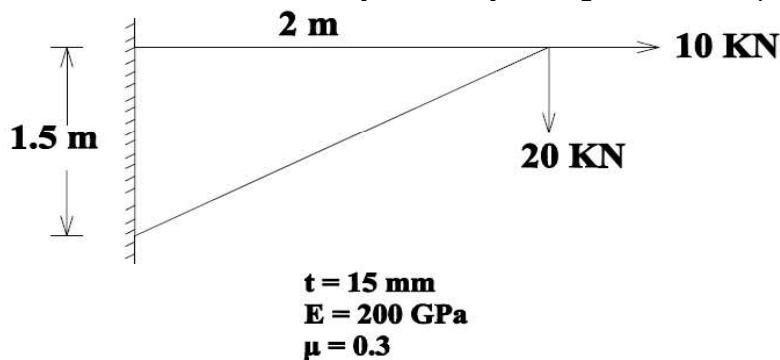

Fig.6

Course Outcome 5(CO5):

1. Discuss about the Isoparametric elements.
2. Infer the expression for the jacobian of transformation matrix of a quadrilateral element.
3. Interpret the expression of shape function for nine node quadrilateral element .

Course Outcome 6(CO6):

1. Solve the integral $\int 3e^x + x^2 + \frac{1}{x+2} dx$ using one point and two point Gauss quadrature formula.
2. Interpret the expression for two dimensional integrals.
3. Solve $\int_{-1}^1 \int_{-1}^1 (x^2 + y^2 + 2xy) dx dy$ using Gauss numerical integration.

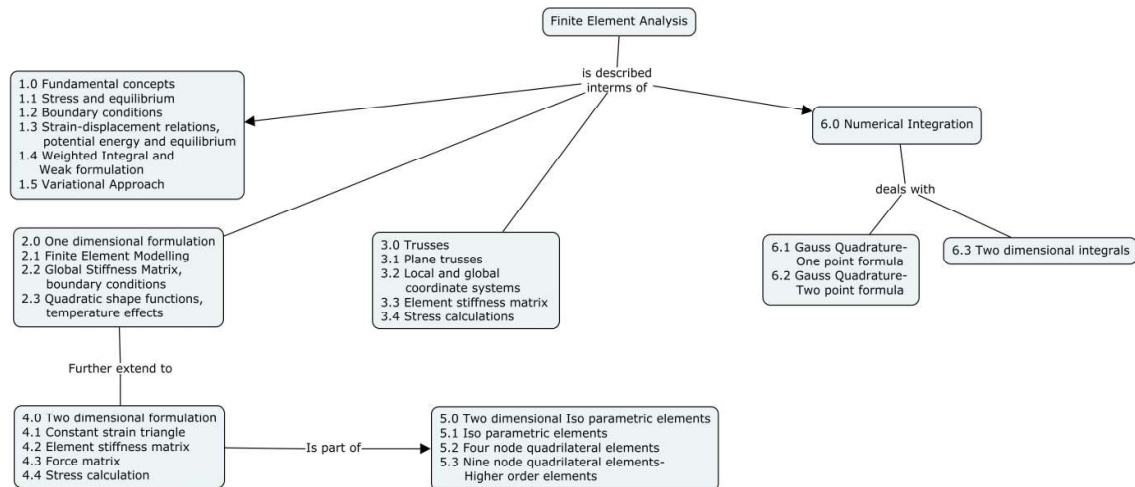
Concept Map**Syllabus**

Fundamental Concepts: Stresses and equilibrium – Boundary conditions – strain-displacement relations – stress-strain relations – potential energy and equilibrium – weighted integral and weak formulation – variational approach. **One dimensional formulation:** Finite element modelling – coordinates and shapes functions – Assembly of global stiffness matrix and global load vector – properties of K – finite element equations – treatment of boundary conditions – quadratic shape functions – temperature effects. **Trusses:** Plane trusses – local –global transformation - stiffness matrix – stress calculations. **Two dimensional formulation:** Finite element modelling – constant strain triangle – problem modelling and boundary conditions - stress calculations. **Two dimensionallisoparametric elements:** Isoparametric elements - four node quadrilateral elements - Stress-strain relationship -Nine node quadrilateral elements-Higher order elements. **Numerical Integration:** One point formula and two point formula – two dimensional integrals.

Learning Resources

1. Tirupathi R. Chandrupatla, Ashok D. Belegundu, "Introduction to finite elements in engineering" Fourth Edition , Prentice Hall of India, New Delhi, 2012.
2. G. Ramamurty, "Applied Finite Element Analysis" [I. K. International publishing house Pvt Ltd.](#) 2010.

3. Singiresu S. Rao, Singiresu S. RAO “The Finite Element Method in Engineering” Elsevier [Butterworth-Heinemann](#) 2005
4. Krishnamoorthy, C.S, “Finite Element Analysis Theory and Programming” Second Edition, Tata McGraw Hill Publishing Co.Ltd. New Delhi 2004.
5. P. Seshu, “Textbook Of Finite Element Analysis “ Prentice Hall of India [Learning Pvt. Ltd.](#) 2003
6. [David V. Hutton](#) “Fundamentals of Finite Element Analysis 1st Edition” Tata McGraw Hill Publishing Co.Ltd. New Delhi 2003.
7. Moaveni, S., Finite Element Analysis : Theory and Application with ANSYS, Prentice Hall Inc., 1999.
8. Zienkiewicz, O.C, and Taylor, R.L., The Finite Elements Methods , Mc Graw Hill , 6th edition 1987.
9. <http://nptel.ac.in/courses/112104116/>
10. <http://nptel.ac.in/courses/105106051/>
11. <http://nptel.ac.in/courses/112104115/>

Course Contents and Lecture Schedule			
Module No.	Topic	No. of Hours	Course Outcome
1	Fundamental Concepts		CO1
1.1	Introduction- Stresses and equilibrium	1	
1.2	Boundary conditions	1	
1.3	Strain-displacement relations, Stress – strain relations – potential energy and equilibrium	1	
1.4	Weighted Integral and Weak formulation	1	
1.5	Variational Approach- Rayleigh Ritz method- Galerkin method	1	
	Tutorial- Variational Approach and Weak formulation	2	
2	One dimensional formulation		CO2
2.1	Introduction – Finite Element Modelling, coordinates and shape functions	1	
2.2	Assembly of Global Stiffness Matrix and Load Vector- Properties of K, finite element equations and treatment of boundary conditions	2	
2.3	Quadratic shape functions, temperature effects	1	
	Tutorial - One dimensional problems	2	
3	Trusses		CO3
3.1	Introduction – Plane trusses	1	
3.2	Local and global coordinate systems	1	
3.3	Element stiffness matrix	1	
3.4	Stress calculations for truss elements	1	
	Tutorial - Truss problems	2	
4	Two dimensional formulation		CO4
4.1	Introduction of two dimensional problems- Constant strain triangle	1	
4.2	Constant strain triangle- Element stiffness matrix	1	
4.3	Constant strain triangle- force matrix	1	
4.4	Constant strain triangle- stress calculation	1	
	Tutorial – two dimensional problems	2	
5	Two dimensional Isoparametric elements		CO5

5.1	Introduction - Isoparametric elements	1	CO6
5.2	Four node quadrilateral elements - Element strain-displacement matrix - Element stiffness matrix	2	
5.3	Nine node quadrilateral elements- Shape functions - Higher order elements	2	
6	Numerical Integration		
6.1	Gauss quadrature- One point formula	1	
	Tutorial -- One point formula	1	
6.2	Gauss quadrature -two point formula	1	
	Tutorial-- Two point formula	1	
6.3	Two dimensional integrals	1	
	Tutorial – Two dimensional integrals	1	
Total Hours		36	

Course Designers:

1. Dr.S.Nagan nagan_civil@tce.edu
2. R.Indrajith Krishnan jith@tce.edu

18CEPB0	DYNAMICS OF STRUCTURES AND EARTHQUAKE ENGINEERING	Category	L	T	P	Credit
		PE	3	0	0	3

Preamble

This course deals with the dynamic analysis of single degree and multi degree freedom system. It covers dynamic response of single degree of freedom system with damping subjected to harmonic excitation and its solving techniques and also the response of linear multi degree of freedom systems with regard to natural frequencies and mode shapes. This course also offers to introduce EQ phenomenon, including the causes, occurrence and its effect on to the built structures and explains all aspects of earthquake resistant design of Reinforced concrete structures

Prerequisite

18CE220-Engineering Mechanics, 18CE420-Structural Analysis

Course Outcomes

On the successful completion of the course students will be able to

CO Number	Course Outcome Statement	Weightage*** in %
CO1	Establish the equation of motion and determine the response of single Degree of freedom system under free vibration with or without damping, logarithmic decrement.	20
CO2	Determine equation of motion and its response of two Degree of Freedom system under free vibration with or without damping in the system and earthquake excitation	20
CO3	Learn the seismology, causes of earthquake and effects of ground motion	10
CO4	Understand how Seismic Hazard analysis helps to obtain Ground motion parameters	10
CO5	exercise the procedure for seismic analysis of RC buildings as per IS 1893 :2002 codal provisions and apply the principles of ductile detailing in reinforced concrete structures as per IS	30

	4326 and IS 13920	
CO6	Evaluate Lateral forces due to torsional eccentricity as per IS Codal provisions and also stresses in masonry piers	10

CO Mapping with CDIO Curriculum Framework

CO #	TCE Proficiency Scale	Learning Domain Level			CDIO Curricular Components (X.Y.Z)
		Cognitive	Affective	Psychomotor	
CO1	TPS3	Apply	Value	Mechanism	1.1.1, 2.1.1, 4.4.1,3.2.5 , 4.4.2, 4.4.3
CO2	TPS3	Apply	Value	Mechanism	1.1.1, 2.1.1, 4.4.1,3.2.5 , 4.4.2, 4.4.3
CO3	TPS2	Understand	Respond	Guided Response	1.1,2.3.1,2.3.2
CO4	TPS2	Understand	Respond	Guided Response	1.1,2.3.1,2.3.2
CO5	TPS3	Apply	Value	Mechanism	2.3.1,2.3.2,4.1.1,4.1.2,4.1.6,
CO6	TPS3	Apply	Value	Mechanism	2.3.1,2.3.2,4.1.1,4.1.2,4.1.6,

Mapping with Programme Outcomes and Programme Specific Outcomes

Cos	PO1	PO2	PO3	PO4	PO5	PO6	PO7	PO8	PO9	PO10	PO11	PO12	PSO1	PSO2
CO 1	S	M	L	----	----	S	S	S	S	----	S	S	M	S
CO 2	S	M	L	----	----	S	S	S	S	----	S	S	M	S
CO 3	M	L	----	----	----	M	S	M	M	----	M	M	L	M
CO 4	M	L	----	----	----	M	S	M	M	----	M	M	L	M
CO 5	S	M	L	----	----	S	S	S	S	----	S	S	M	S
CO 6	S	M	L	----	----	S	S	S	S	----	S	S	M	S

S- Strong; M-Medium; L-Low

Assessment Pattern: Cognitive Domain

Cognitive Levels	Continuous Assessment Tests			Assignment			Terminal Examination
	1	2	3	1	2	3	
Remember				-	-	-	
Understand	40	40	40	50	50	50	40
Apply	60	60	60	50	50	50	60
Analyse							
Evaluate							
Create							

Assessment Pattern: Psychomotor

Psychomotor Skill	Miniproject/Assignment/Practical Component
Perception	
Set	

Guided Response	50
Mechanism	50
Complex Overt Responses	
Adaptation	
Origination	

Sample Questions for Course Outcome Assessment**

** (2 to 3 at the cognitive level of course outcome)

Course Outcome1(CO1):

1. Write the equation governing the vibration of the system as shown in figure-1, formed of point mass attached to the tip of massless clamped beam of length l and bending stiffness EI and a spring with stiffness k .

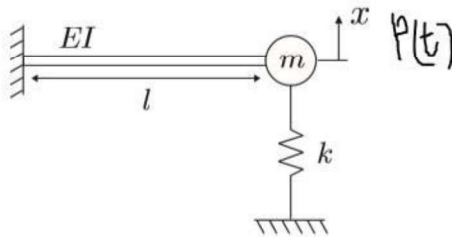

Figure-1

2. Write the equation motion of the one storey, one bay frame as shown in figure-2.

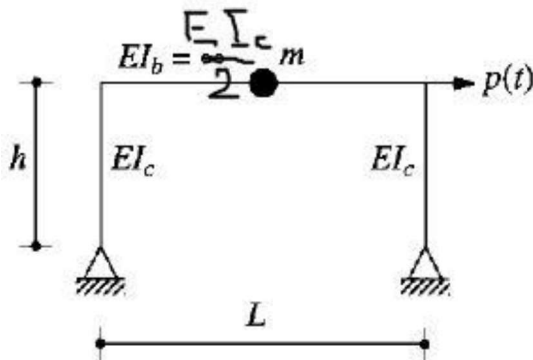

Figure-2

3. Write the equation governing the motion of the system as shown in figure-3, formed of point mass attached to the tip of massless clamped beam of length l and bending stiffness EI and a spring with stiffness k .

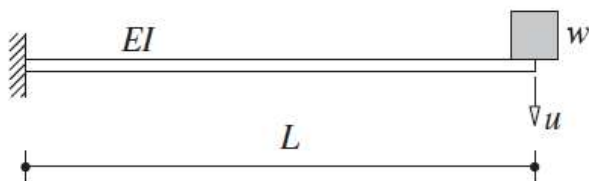
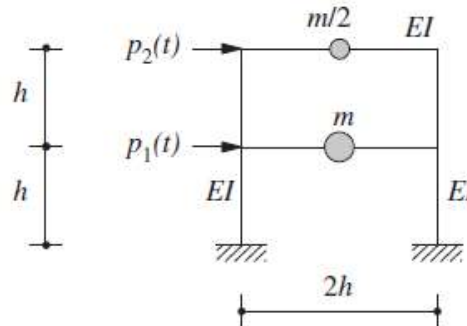

Figure-3

CourseOutcome2 (CO2):

Determine equation of motion and its response of two Degree of Freedom system under free vibration with or without damping in the system and earthquake excitation

1. Determine the natural frequencies and modes of the system defined in the figure-1. Express the frequencies in terms of m , EI and h and normalize each mode to unit displacement at the roof and sketch it, identifying all DOFs. [Hint: Given frame is not a shear frame]

**Figure-1**

2. For the two storey shear frame as shown in figure-2 excited by horizontal ground motion $\ddot{U}_g(t)$, determine a) the modal expansion of effective earthquake forces b) the floor displacement in terms of $D_n(t)$, c) the story shear in terms of pseudo acceleration. (1 feet = 0.3048m)

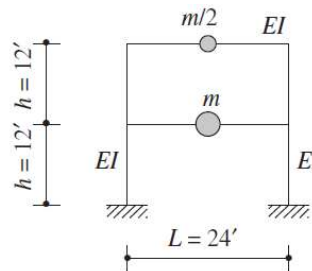
**Figure-2****CourseOutcome3 (CO3):**

1. What causes the apparently solid and rigid Earth to move and so produce an earthquake?
2. How to make buildings ductile for good seismic performance? How buildings twist during earthquake
3. How do Beam-Column Joints in RC Buildings Resist Earthquakes?

Course Outcome 4 (CO4):

1. Define moment magnitude
2. Write the steps involved in Deterministic Seismic Hazard Analysis (DSHA)
3. Write the steps involved in Probabilistic Seismic Hazard Analysis (PSHA)

Course Outcome 5 (CO5):

1. For the three storey RCC School building of your choice determine the design seismic loads on the structure by the Equivalent static analysis. The building is located in seismic zone V. The type of soil encountered is medium stiff and it is proposed to design the

building with a special moment resisting frame. The intensity of dead load is 10 kN/m^2 and floors are to cater to an imposed load of 3 kN/m^2

- Design for lintel and Roof band of a single room building of size $6 \text{ m} \times 4 \text{ m}$. The walls are 200 mm thick in modular bricks built in $1:5$ cement sand mortar. The height of building up to lintel level is 3 m and the vertical distance between the roof band and lintel band is 1.5 m . The roof band weighs 750 kg/m^2 . The bands are required for a design earthquake coefficient of 0.12 . Weight of wall is 450 kg/m^2 . Weight of masonry is 1900 kg/m^2 .
- Discuss the ductile detailing requirements as per codal provisions for the columns and beams in RC structures

Course Outcome 6 (CO6):

- A simple one storey building having two shear walls in each directions is as shown in fig1. All the four walls are in M25 grade concrete and 200 mm thick. The storey height is 3.5 m . Design shear force for the building is 100 kNm in either direction. Compute the design lateral forces on different shear walls using the torsion provisions of IS1893(Part I) Assume suitable data if required)

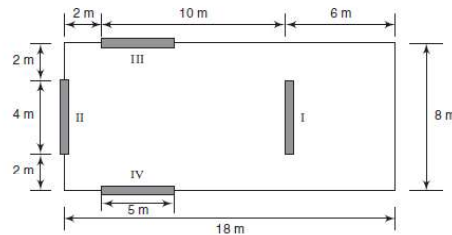
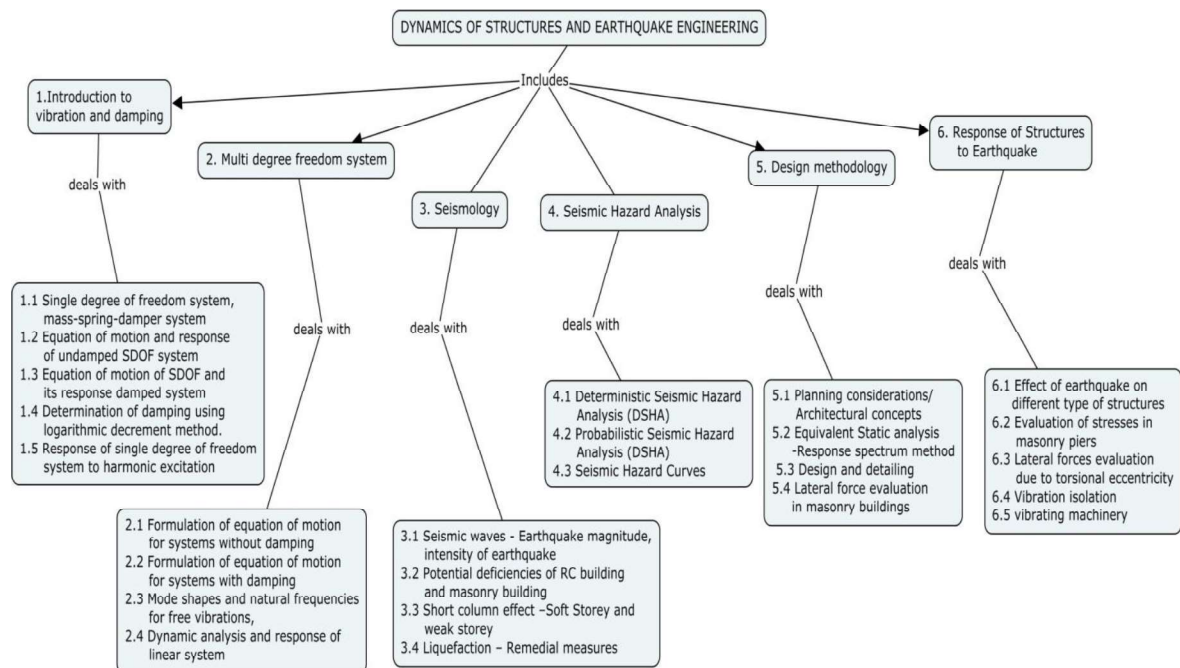

fig1

- Write the formula to calculate overturning stresses in masonry piers
- Discuss the effect of earthquake on different type of structures

ConceptMap



Syllabus

Introduction to vibration and damping, Single degree of freedom system, mass-spring-damper system. **Free vibration**: Formation of equation of motion and response of undamped and damped system, Determination of damping using logarithmic decrement method. **Forced vibration**: Response of single degree of freedom system to harmonic and periodic excitation of undamped and damped system. **Multi degree freedom system**: formulation of equation of motion for two/ three degree of freedom systems, finding mode shapes and natural frequencies for free vibrations, damping in structures Dynamic analysis and response of linear system. **Seismology** Introduction – Seismic waves - Earthquake magnitude, intensity of earthquake, epicentre – Plate tectonics -Seismic Energy –EQ resistance in masonry building – Short column effect –Soft Storey - Centre of stiffness – Centre of mass – liquefaction-Potential deficiencies of RC building and masonry building – Remedial measures -**Seismic Hazard Analysis** Deterministic Seismic Hazard Analysis (DSHA) - PSHA **Design methodology** Planning considerations / Architectural concepts as per IS:4326 – 1993 – Guidelines for Earthquake resistant design – Lateral load analysis – Equivalent Static analysis -Response spectrum method as per IS 1893:2002- Design and detailing as per IS:13920 – 1993.Lateral force evaluation in masonry buildings **Response Of Structures To Earthquake** Effect of earthquake on different type of structures – RCC, Steel and Masonry Structure -Evaluation of stresses in masonry piers -Lateral forces evaluation due to torsional eccentricity -. Vibration isolation – vibrating machinery – vibrating foundation

Learning Resources

1. Anil K.Chopra, “Dynamics of Structures: Theory and Applications to Earthquake Engineering”, Prentice Hall, Englewood Cliffs, New Jersey, Second Edition, 2012.
2. Clough, R.W. and Penzien,J., “ Dynamics of Structure”,McGraw-Hill,inc.,New York 2003.
3. Mario Paz, “Structural Dynamics: Theory and Computation”, CBS Publications, New Delhi, 2004.
4. Berg. Glen v., “Elements of Structure Dynamics” ‘Prentice Hall Englewood Cliffs, New Jersey. 1989.
5. Cheng, F.Y., “Matrix Analysis of Structure Dynamics”, Marcel Dekker, New York, 2001.
6. Manicka Selvam K., “Elementary Structural Dynamics”, Dhanpatrai and sons, New Delhi,2001.
7. Hurty.W.C, Rubinstein.M.F, ”Dynamic of Structure”, Prentice Hall of India Pvt Ltd.New Delhi.
8. Pankaj Agarwal and Manish Shrikhande, “Earthquake Resistant Design of Structures”, Prentice Hall of India, New Delhi, 2009
9. Mohiuddin Ali Khan, “Earthquake Resistant Structures: Design, Build and Retrofit”, Elsevier Science & Technology, 2012
10. . S.K. Duggal, “Earthquake Resistant Design of Structures”, Oxford University Press, New Delhi, 2007.

Course Contents and Lecture Schedule

Module No.	Topic	No. of Hours	Course Outcome
1.	Introduction to vibration and damping		
1.1	Single degree of freedom system, mass-spring-damper system	1	CO1
	Free vibration and Forced vibration		
1.2	Equation of motion and response of undamped SDOF system, formation of equation of motion undamped system	1	CO1
1.3	Formation of equation of motion of SDOF and its response damped system	1	CO1

1.4	Delay in motion. Determination of damping using logarithmic decrement method.	1	CO1
1.5	Response of single degree of freedom undamped and damped system to harmonic excitation	1	CO1
2	Multi degree freedom system:		
2.1	Formulation of equation of motion for two/ three degree of freedom systems with or without damping	1	CO2
2.2	Formulation of equation of motion for two/ three degree of freedom systems with damping	2	CO2
2.3	Finding mode shapes and natural frequencies for free vibrations,	2	CO2
2.4	Dynamic analysis and response of linear system.	1	CO2
3.	Seismology,		
3.1	Seismic waves - Earthquake magnitude, intensity of earthquake	1	CO3
3.2	Potential deficiencies of RC building and masonry building	3	CO3
3.3	Short column effect –Soft Storey and weak storey	1	CO3
3.4	Liquefaction – Remedial measures	2	CO3
4.	Seismic Hazard Analysis		
4.1	Deterministic Seismic Hazard Analysis (DSHA)	2	CO4
4.2	Probabilistic Seismic Hazard Analysis (DSHA)	2	CO4
4.3	Seismic Hazard Curves	1	CO4
5.	Design methodology		
5.1	Planning considerations / Architectural concepts as per IS:4326 – 1993	1	CO5
5.2	Equivalent Static analysis -Response spectrum method as per IS 1893:2002	3	CO5
5.3	Design and detailing as per IS:13920 – 1993	2	CO5
5.4	Lateral force evaluation in masonry buildings	1	CO5
6.	Response of Structures to Earthquake		
6.1	Effect of earthquake on different type of structures – RCC, Steel and Masonry Structure	1	CO6
6.2	Evaluation of stresses in masonry piers	2	CO6
6.3	Lateral forces evaluation due to torsional eccentricity	1	CO6
6.4	Vibration isolation	1	CO6
6.5	vibrating machinery	1	CO6

Course Designers:

1. Dr.S.Arul Mary samciv@tce.edu
2. Dr.R.Ponnudurai rpdciv@tce.edu
3. Mr. R.Indirajithkrishnan iith@tce.edu

18CEPC0	PRESTRESSED CONCRETE				
	Category	L	T	P	Credit
	PE	3	0	0	3

Preamble

Prestressed concrete is used extensively in bridges, multistorey buildings and many other important parts of today's modern infrastructure. The inherent weakness of concrete in tension is offset by introducing a pre-compression in a prestressed member, which improves its service load behaviour such as reduced deflections and cracking. An advanced understanding of its behaviour is essential before safe and economical designs can be produced. This course will provide a detailed coverage of the behaviour of prestressed concrete, analysis and design for strength and serviceability of prestressed concrete members, such as beams and slabs including continuous members, and anchorage design and losses in prestress under IS codal provisions.

Prerequisite

18CE610 Design of Reinforced Concrete Elements

Course Outcomes

On the successful completion of the course students will be able to

CO Number	Course Outcome Statement	Weightage*** in %
CO1	Describe the systems and methods of prestressing and its analysis	15
CO2	Determine the losses of prestress and deflection of prestressed concrete beams	15
CO3	Analyse and design the prestressed concrete beams and slabs under various forces	20
CO4	Analyse the prestressed concrete continuous beams	10
CO5	Analyse and design the circular prestressed concrete members	20
CO6	Analyse the composite prestressed concrete members	20

*** Weightagedepends on Bloom's Level, number of contact hours,

CO Mapping with CDIO Curriculum Framework

CO #	TCE Proficiency Scale	Learning Domain Level			CDIO Curricular Components (X.Y.Z)
		Cognitive	Affective	Psychomotor	
CO1	TPS3	Apply	Value	Mechanism	1.1.1,1.2,2.1.1
CO2	TPS3	Apply	Value	Mechanism	1.1.1,1.2,2.1.1,
CO3	TPS3	Apply	Value	Mechanism	1.1.1,1.2,2.1.1,2.1.5,4.4.1
CO4	TPS3	Apply	Value	Mechanism	1.1.1,1.2,2.1.1,2.1.5,2.4.3,2.4.4

CO5	TPS3	Apply	Value	Mechanism	1.1.1,1.2,2.1.1,2.1.5,4.4.1
CO6	TPS3	Apply	Value	Mechanism	1.1.1,1.2,2.1.1,2.1.5

Mapping with Programme Outcomes and Programme Specific Outcomes

COS	PO1	PO2	PO3	PO4	PO5	PO6	PO7	PO8	PO9	PO10	PO11	PO12	PSO1	PSO2
CO1	S	M	L	---	---	S	M	S	S	---	S	S	M	M
CO2	S	M	L	---	---	S	M	S	S	---	S	S	M	M
CO3	S	M	L	---	---	S	M	S	S	---	S	S	M	M
CO4	S	M	L	---	---	S	M	S	S	---	S	S	M	M
CO5	S	M	L	---	---	S	M	S	S	---	S	S	M	M
CO6	S	M	L	---	---	S	M	S	S	---	S	S	M	M

S- Strong; M-Medium; L-Low

Assessment Pattern: Cognitive Domain

Cognitive Levels	Continuous Assessment Tests			Assignment			Terminal Examination
	1	2	3	1	2	3	
Remember	10	10	10	-	-	-	10
Understand	10	10	10	-	-	-	10
Apply	80	80	80	100	100	100	80
Analyse							
Evaluate							
Create							

Assessment Pattern: Psychomotor

Psychomotor Skill	Assignment
Perception	-
Set	-
Guided Response	50
Mechanism	50
Complex Overt Responses	-
Adaptation	-
Origination	-

Sample Questions for Course Outcome Assessment**

Course Outcome 1 (CO1):

1. What are the reasons for using high tensile steel wires in prestressed concrete structures?
2. Differentiate between pretensioning and post tensioning systems.
3. Explain Fressinet system of post tensioning method with neat sketches

Course Outcome 2 (CO2):

1. What are the factors influencing the deflection of prestressed concrete members?

2. A prestressed concrete beam 250mm wide and 400mm deep is prestressed by 14 wires each of 7mm diameter initially stressed to 1300 N/mm² with their centroids located 120mm from the soffit. The span of the beam is 11m. Determine the percentage loss of stress in wires if (a) the beam is pretensioned and (b) the beam is post-tensioned using the following data: relaxation of steel stress = 5% of initial stress, $E_s=210 \text{ kN/mm}^2$, $E_c=35 \text{ kN/mm}^2$, creep coefficient=1.6 and residual shrinkage strain = 3×10^{-4} for pretensioning and 2×10^{-4} for post-tensioning, slip at anchorage=1mm, Frictional coefficient for wave effect=0.0020 per m.
3. A prestressed concrete beam spanning over 10m is of rectangular section, 230mm wide and 500mm deep. The beam is prestressed by a parabolic cable having an eccentricity of 150mm below the centroidal axis at the centre of span and an eccentricity of 75mm above the centroidal axis at the support sections. The initial force in the cable is 450 kN. The beam supports an UDL of 15 kN/m. $E_c = 38 \text{ kN/mm}^2$. Neglecting losses of prestress, a) calculate the short term deflection due to prestress and self weight; b) Allowing for 20 percent loss in prestress, calculate the long term deflection under prestress, self weight and live load, assuming the creep coefficient as 1.80.

Course Outcome 3 (CO3):

1. What is the formula to find out the ultimate shear resistance of a section uncracked in flexure as per IS code?
2. A prestressed concrete beam of rectangular section 150mm x 300mm is prestressed by a straight cable placed at an eccentricity 50mm below the neutral axis carrying an effective prestress of 180 Kn. The beam supports an udl of 18 Kn/m including self-weight. Determine shear resistance of uncracked section at supports and design the shear reinforcement. Take $f_{ck}=40 \text{ Mpa}$ and $\text{span}=8\text{m}$.
3. Design a simply supported prestressed concrete slab for the following conditions. Span of the slab is 13m. Safe stress in concrete is 14 N/mm^2 . Safe stress in steel is 1200 N/mm^2 . Super imposed load is 23 kN/m^2 .

Course Outcome 4 (CO4):

1. What is concordant cable profile?
2. Explain the concept of linear transformation in prestressed concrete continuous members.
3. In two equal span prestressed concrete continuous beam ABC, the tendon has an eccentricity of 0.05m at support A and is bent sharply at a distance of 4m from A having an eccentricity of 0.12m in the span AB below the centre of the beam. And the tendon has an eccentricity of 0.15m at the support B above the centre of the beam. Then the tendon has a parabolic profile for the span BC having mid point eccentricity of 0.15m below the centre of the beam and zero at the support C. Locate the line of pressure (C-line) due to prestress alone. The prestressing force is 1200 kN. Calculate the extreme stresses in concrete at the section over the middle support. The size of the beam is 300mm x 600mm.

Course Outcome 5 (CO5):

1. Draw the location of P-line and C-line in the prestressed concrete circular water tank.
2. A prestressed concrete tank of diameter 10m has to resist an internal pressure head of 4m of water. Design the reinforcement required per metre height and the thickness of concrete required. Take F_c =Ultimate strength of concrete = 40 N/mm^2 , f_c =safe stress in concrete= $0.5F_c$ at transfer, $f_s=1300 \text{ N/mm}^2$, loss of prestress=20%, $m=8.0$
3. Design a non-cylinder prestressed pipe of 600mm diameter to withstand a working pressure of 1 N/mm^2 and calculate the test pressure required to produce a tensile stress of 0.7 N/mm^2 in the concrete when applied immediately after tensioning. $F_{et}=14 \text{ N/mm}^2$ and $k=0.80$.

Course Outcome 6 (CO6):

1. What are the advantages of having prestressed concrete structures in composite construction?
2. Explain the analysis of stresses in composite construction with neat sketches.
3. Calculate the resultant stress developed in the precast and insitu cast concrete when the beam is propped during the casting of slab. The size of the beam is 150mm x 300mm. Assume the same modulus of elasticity for concrete in precast beam and insitu cast slab. The beam with an effective span of 4.5m is prestressed by tendons with their centroids coinciding with the bottom kern. The initial force in the tendons is 150 kN. The loss of prestress may be assumed to be 18%. The beam is incorporated in a composite T-beam by casting a top flange of breadth 450mm and thickness 50mm. The composite beam supports a live load of 4.5 kN/m².

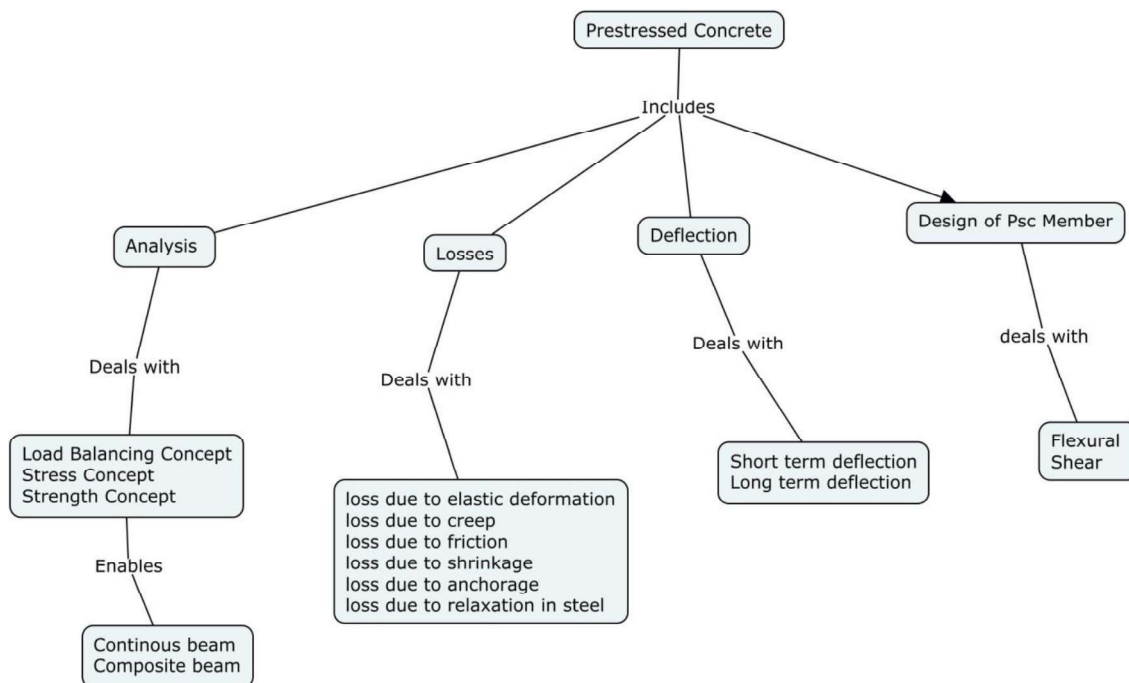
Concept Map**Syllabus**

Systems of prestressing and its analysis: Basic concepts of prestressing, need for high strength steel and concrete, advantages, applications, pre-tensioning and post-tensioning systems, partial prestressing; Analysis of prestress -resultant stress at a section – concentric tendon, eccentric tendon, bent tendon, parabolic tendon, pressure line or thrust line, concept of load balancing, cracking moment. **Losses of prestress and Deflection of PSC members:** Loss due to elastic deformation of concrete, shrinkage of concrete, creep of concrete, relaxation of stress in steel, friction and anchorage; Factors influencing deflection and its importance, short term deflection – tendons of various profile, self weight and imposed loads; long term deflections. **Flexural and shear strength of PSC members:** IS codal provisions - flexural strength, shear resistance, web shear crack, flexure-shear cracks; Design of sections for flexure and shear; Design of slabs; Design of Anchorage zone using IS and Magnel methods. **Continuous PSC members:** Advantages, primary moment, secondary moment, resultant moment, pressure or thrust line, line of prestress, concordant cable profile, concept of linear transformation, analysis of two span continuous beams. **Circular prestressing:** Analysis & design of prestressed concrete pipes, poles and water tanks. **Composite PSC members:** Types and analysis of composite members, deflection of composite members.

Learning Resources

1. N. Krishna Raju, Prestressed Concrete, Tata McGraw Hill Publishing Co. Ltd, New Delhi, 2018
2. N. Rajagopalan, Prestressed Concrete, Alpha Science International Ltd, New Delhi, 2005
3. T.Y. Lin, & Ned. H. Burns, Design of Prestressed Concrete Structures, John Wiley & Sons, New York, 2010.
4. Arthur H.Nilson, Design of Prestressed Concrete, John Wiley & Sons, New York, 2011.
5. P. Dayaratnam, Prestressed Concrete Structures, Oxford and IBH, New Delhi, 2017.
6. Ramaswamy G.S., Modern pre-stressed concrete design, Arnold Heinimen, New Delhi, 2005.
7. Self learning materials – NPTEL - <http://www.nptel.ac.in/courses/105106117/>

IS Codes

1. IS 1343: 2012 Code of Practice for Pre Stressed Concrete
2. IS 3370 (Part 3): 1967 Code of Practice for Concrete Structures for the Storage of Liquids-Part 3 Pre stressed Concrete
3. IS 3370 (Part 4): 1967 Code of Practice for Concrete Structures for the Storage –Part-4 Design Tables
4. IS 784:2001 Prestressed concrete pipes (including specials) - Specification.

Course Contents and Lecture Schedule – Theory Part

Module No.	Topics	No. of Lectures	Course Outcomes
1.	Systems of prestressing and its analysis		
1.1	Basic concepts of prestressing, need for high strength steel and concrete, advantages, applications and partial prestressing	1	CO1
1.2	Pre-tensioning system – Hoyer's method	1	CO1
1.3	Post-tensioning systems – Freyssinet, Gifford-Udall, Magnel-Blaton, Lee-McCall systems	2	CO1
1.4	Analysis of prestress -resultant stress at a section – concentric tendon, eccentric tendon, bent tendon, parabolic tendon, pressure line or thrust line, concept of load balancing, cracking moment.	2	CO1
2.	Losses of prestress and Deflection of PSC members		
2.1	Due to elastic deformation of concrete and shrinkage of concrete	1	CO2
2.2	Due to creep of concrete and relaxation of stress in steel	1	CO2
2.3	Due to friction and anchorage	1	CO2
2.4	Factors influencing deflection and its importance	1	CO2
2.5	Short term deflection – tendons of various profile – self weight and imposed loads; long term deflections	2	CO2
3.	Flexural and shear strength of PSC members		
3.1	IS codal provisions - Flexural strength	1	CO3

3.2	Shear resistance – web shear crack, flexure-shear cracks	1	CO3
3.3	Design of sections for flexure	1	CO3
3.4	Design of section for shear	1	CO3
3.5	Design of slabs	1	CO3
3.6	Design of Anchorage zone reinforcement - IS and Magnel methods	2	CO3
4.	Continuous PSC members		
4.1	Advantages, primary moment, secondary moment, resultant moment, pressure or thrust line, line of prestress	1	CO4
4.2	Concordant cable profile, concept of linear transformation	1	CO4
4.3	Analysis of two span continuous beams - Procedure	2	CO4
4.4	Analysis of two span continuous beams	2	
5.	Circular prestressing		
5.1	Analysis & design of prestressed concrete pipes	2	CO5
5.2	Analysis & design of prestressed concrete pole	2	
5.3	Analysis & design of water tanks	2	CO5
6.	Composite Construction		
6.1	Types of composite members	1	CO6
6.2	Analysis of composite members	2	
6.3	Deflection of composite members	2	CO6
	Total	36	

Course Designers:

1. Dr. K Sudalaimani, ksudalaimani@tce.edu
2. Dr.M.C.Sundarraja, mcsciv@tce.edu
3. R. Sankaranarayanan, rsciv@tce.edu

18CEPD0	BRIDGE ENGINEERING
----------------	---------------------------

Category	L	T	P	Credit
PE	3	0	0	3

Preamble

Bridge is a [structure](#) built to [span](#) physical obstacles without closing the way underneath such as a [body of water](#), [valley](#), or [road](#), for the purpose of providing passage over the obstacle. There are many different designs that each serve a particular purpose and apply to different situations. Designs of bridges vary depending on the function of the bridge, the nature of the [terrain](#) where the bridge is constructed and anchored, the material used to make it, and the funds available to build it. This course offers the design of bridges such as RCC bridges, design principles of steel and prestressed concrete bridges, design principles of substructure and design of different types of bearings as per IRC loadings standards, Indian Railway standards bridge rules and MOST codes. It aims at determination of safe as well as economical section using different kinds of material used in construction and maintenance.

Prerequisite

Knowledge of Strength of Materials, Mechanics of Solids, Structural Analysis, Design of RCC, Design of Steel Structures and Prestressed Concrete

Course Outcomes

On the successful completion of the course students will be able to

CO Number	Course Outcome Statement	Weightage*** in %
CO1	Understand the type of bridge and its basic requirements for particular location	10
CO2	Design the culverts and deck slab bridges	15
CO3	Design the long span bridges	25
CO4	Design the steel bridges	15
CO5	Design prestressed concrete bridges	15
CO6	Design bridge bearings and piers	20

*** Weightage depends on Bloom's Level, number of contact hours,

CO Mapping with CDIO Curriculum Framework

CO #	TCE Proficiency Scale	Learning Domain Level			CDIO Curricular Components (X.Y.Z)
		Cognitive	Affective	Psychomotor	
CO1	TPS2	Understand	Respond	Guided Response	1.2,2.1.1
CO2	TPS3	Apply	Value	Mechanism	1.1.1, 1.2, 1.3, 2.1.3, 2.1.4, 2.1.5, 4.4.1, 4.4.2, 4.4.3
CO3	TPS3	Apply	Value	Mechanism	1.1.1, 1.2, 1.3, 2.1.3, 2.1.4, 2.1.5, 4.4.1, 4.4.2, 4.4.3
CO4	TPS3	Apply	Value	Mechanism	1.1.1, 1.2, 1.3, 2.1.3, 2.1.4, 2.1.5, 4.4.1, 4.4.2, 4.4.3
CO5	TPS3	Apply	Value	Mechanism	1.1.1, 1.2, 1.3, 2.1.3, 2.1.4, 2.1.5, 4.4.1, 4.4.2, 4.4.3
CO6	TPS3	Apply	Value	Mechanism	1.1.1, 1.2, 1.3, 2.1.3, 2.1.4, 2.1.5, 4.4.1, 4.4.2, 4.4.3

Mapping with Programme Outcomes and Programme Specific Outcomes

Cos	PO1	PO2	PO3	PO4	PO5	PO6	PO7	PO8	PO9	PO10	PO11	PO12	PSO1	PSO2
CO1	M	L	----	----	----	M	S	M	M	----	M	M	L	M
CO2	S	M	L	----	----	S	S	S	S	----	S	S	M	S
CO3	S	M	L	----	----	S	----	S	S	----	S	S	M	S
CO4	S	M	L	----	----	S	S	S	S	----	S	S	M	S
CO5	S	M	L	----	----	S	S	S	S	----	S	S	M	S
CO6	S	M	L	----	----	S	S	S	S	----	S	S	M	S

S- Strong; M-Medium; L-Low

Assessment Pattern: Cognitive Domain

Cognitive Levels	Continuous Assessment Tests			Assignment			Terminal Examination
	1	2	3	1	2	3	
Remember	10	10	10	-	-	-	10
Understand	10	10	10	-	-	-	10
Apply	80	80	80	100	100	100	80
Analyse				-	-	-	
Evaluate				-	-	-	
Create							

Assessment Pattern: Psychomotor

Psychomotor Skill	Mini project /Assignment/Practical Component
Perception	-
Set	-
Guided Response	-
Mechanism	Assignment
Complex Overt Responses	-
Adaptation	-
Orignation	-

Sample Questions for Course Outcome Assessment**

** (2 to 3 at the cognitive level of course outcome)

Course Outcome1(CO1):

Define linear waterway.

1. State the minimum width of carriage way for single lane traffic?
2. Explain in detail the points to be considered while selecting an ideal bridge site?

Course Outcome2(CO2):

1. Draw a neat sketch of a bridge and mark all its components, also explain the importance of each component.
2. List out the various components of slab culvert.
3. Design a deck slab bridge for the following data:

Clear distance between abutments: 7m

Road	: NH (Two Lane)
Foot path	: 1m on either side
Width of bearing	: 400 mm
Wearing coat	: 80mm average
Loading	: IRC Class AA (Tracked)
Materials	: M30 concrete and Fe 415 Steel

Course Outcome3(CO3):

1. Draw the position of IRC class 'AA' Tracked vehicle wheel load for getting maximum bending moment.
2. Design the articulation of balanced cantilever bridge of span 70 m, carriage way two lanes, loading class 70R tracked vehicle, Materials: M25 grade concrete and Fe415 steels are used.
3. List any two advantages of balanced cantilever bridge.

Course Outcome 4 (CO4):

1. Draw the neat of truss bridge.
2. Explain the loads considered in Railway bridges.
3. What are the factors to be considered in selecting paint for steel bridge?

Course Outcome 5 (CO5):

1. Give the advantages of prestressed concrete bridges.
2. Define the terms: Maximum and Minimum prestressing forces.
3. Explain in detail in finding the eccentricity of cables in prestressed concrete bridges.

Course Outcome6(CO6):

1. Write the equation for calculating the scour depth for natural streams in alluvial soil.
2. List out the various classification of a fixed bearings.
3. Design a R.C rocker bearing to transmit a support reaction of 1000 kN. permissible bearing stress in concrete is 8 Mpa. Use M30 grade concrete and Fe 415 grade steel.

Concept Map

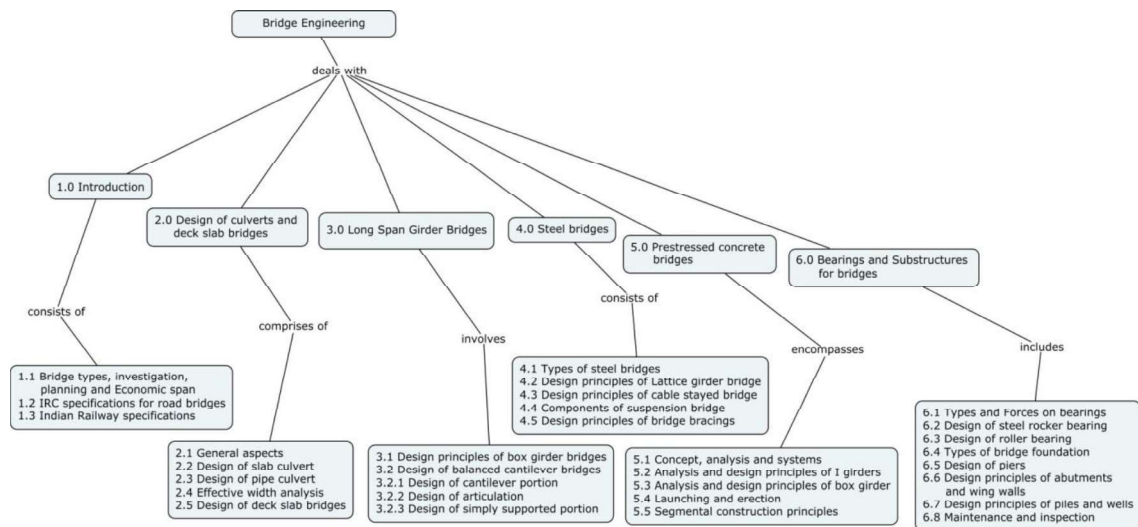

Syllabus

Introduction: Classification of bridges, investigations and planning, linear water way, economic span length- IRC specifications for road bridges -standard live loads, other forces acting on bridges - Indian Railway codal provisions for broad gauge single line and double line, general design considerations **Design of culverts and deck slab bridges:** General aspects - design of slab culvert - design of pipe culvert- slab design as effective width analysis - design of deck slab bridges for IRC loadings **Long Span Girder Bridges:** Design principles of box girder bridges- design of balanced cantilever bridges- cantilever portion – articulation - simply supported portion **Steel bridges:** Types of steel bridges - design principles of lattice girder bridges - cable stayed bridge - components of suspension bridge - design of bridge bracings **Prestressed concrete bridges:** Concept, analysis and systems - analysis and design principles of I girders - analysis and design principles of box type girder - launching and erection details with case studies - segmental construction principles **Bearings and substructures for bridges:** Types of bearings, forces on bearings, basis for selection of bearings - design of steel rocker bearing - design of roller bearing - Types of bridge foundation - design of piers - design principles of abutments and wing walls - piles and wells - general features - maintenance and inspection of bridges.

Learning Resources

1. Krishna Raju. N. "Design of Bridges", 4th Edition, Oxford & IBH, New Delhi 2010.
2. Johnson Victor.D, "Essentials of Bridge Engineering", 6th Edition, Oxford & IBH Publishers Co. Pvt. Ltd, New Delhi 1999.
3. Ponnuswamy.S., "Bridge Engineering", 2nd Edition, Tata McGraw Hill Publications, New Delhi, India 2007
4. IRC: 78, "Standard specifications & Code of practice for Road Bridges".Section VII- Foundation and Substructures.
5. IRC: 6-2000, " Standard specifications & Code of practice for Road Bridges".Section II- Loads and Stresses.
6. IRC: 21-2000, " Standard specifications & Code of practice for Road Bridges".Section III-Cement Concrete (Plain and Reinforced).
7. IRC: 83 Part II-1987, "Standard specifications & Code of practice for Road Bridges".Section : 9 Bearing, Part II – Elastomeric Bearings.
8. IRC: 45-1972, " Recommendations for Estimating the resistance of soil below the maximum scour level in the Design of Well foundations of Bridges.
9. IRC: 24-2000 "Standard specifications & code of practice for steel bridges".
10. IRC: 87-1984, "Guidelines for the Design and Erection of False work for Road Bridges.
11. IS 1343:1980 Code of Practice for Pre Stressed Concrete
12. IRS: 1 1977, Bridge rules.
13. IRS: 2, "Code of practice for plain, reinforced and prestressed concrete for general bridge construction.
14. MOST standard plans for 3.0m to 10m span reinforced cement concrete solid slab superstructure with and without foot paths for highways, (1991).
15. MOST standard plans for highways bridges RCC.T-Beams and slab superstructure – span from 10m to 24m width.
16. MOST standard plans for highway bridges PSC girder and RC slab composite superstructure for 30m span with and without foot paths, 35m span with footpaths, 40m span without foot paths, 1992.
17. MOST standard drawings for road bridges- RCC solid slab superstructure (15° and 30° SKEW) span 4m to 10m (with and without foot paths), 1992.

18. MOST standard drawing for road bridges-RCC solid slab superstructure (22.5°SKEW) span 4m to 10m (with and without foot paths), 1996.
19. IS 2911, 1980 code of practice for pile foundation.

Course Contents and Lecture Schedule			
Module No.	Topic	No. of Hours	Course Outcome
1.0	Introduction		
1.1	Classification of bridges, investigations and planning, linear water way, economic span length	1	CO1
1.2	IRC specifications for road bridges - standard live loads, other forces acting on bridges	1	CO1
1.3	Indian Railway codal provisions for broad gauge single line and double line, general design considerations	1	CO1
2.0	Design of culverts and deck slab bridges		
2.1	General aspects	1	CO2
2.2	Design of slab culvert	2	CO2
2.3	Design of pipe culvert	2	CO2
3.0	Design of deck slab bridges		
3.1	Slab design as Effective width analysis	2	CO3
3.2	Design of deck slab bridges for IRC loadings	2	CO3
3.3	Design of T beam deck slab bridges for IRC loadings	2	CO3
3.4	Design principles of box girder bridges	1	CO3
3.5	Design of Box girder bridges	1	CO3
4.0	Steel bridges		
4.1	Types of steel bridges	1	CO4
4.2	Design principles of Lattice girder bridges	1	CO4
4.3	Design principles of cable stayed bridge	1	CO4
4.4	Components of suspension bridge	1	CO4
4.5	Design principles of bridge bracings	2	CO4
5.0	Prestressed concrete bridges		
5.1	Concept, analysis and systems	1	CO5
5.2	Analysis and design principles of I girders	1	CO5
5.3	Analysis and design principles of box type girder	1	CO5
5.4	Launching and erection details with case studies	1	CO5
5.5	Segmental construction principles	1	CO5
6.0	Bearings and Substructures for bridges		
6.1	General features - Types of bearings, Forces on bearings	1	CO6
6.2	Design of steel rocker bearing	1	CO6
6.3	Design of roller bearing	1	CO6
	Substructures for bridges		
6.4	Types of bridge foundation	1	CO6
6.5	Design of piers	2	CO6
6.6	Design principles of abutments and wing walls	1	CO6
6.7	Design principles of piles and wells	1	CO6
6.8	Maintenance and inspection of bridges	1	CO6
	TOTAL	36	

Course Designers:

- | | | |
|----|------------------|----------------------|
| 1. | Dr.K.Sudalaimani | ksudalaimani@tce.edu |
| 2. | Dr.R.Ponnudurai | rpdcciv@tce.edu |

18CEPE0	FRACTURE MECHANICS				
	Category	L	T	P	Credit
	PE	3	0	0	3

Preamble

The conventional design of a structure does not take in to account flaws or cracks in the materials, which largely affect the residual strength of a structure. The aim of this course is to predict the crack front growth and instability under elastic and elasto plastic conditions and to compute the stress intensity factors and strain energy release rate. This course is designed to show how these concepts can be integrated and applied to practical engineering problems using modern computational mechanics techniques.

Prerequisite

Mechanics of Materials

Course Outcomes

On the successful completion of the course students will be able to

CO Number	Course Outcome Statement	Weightage*** in %
CO1	Understand the various theories of failures of structural materials with pre existing cracks	10
CO2	Apply the principles of Linear Elastic Fracture Mechanics	25
CO3	Understand Elastic Plastic Fracture Mechanics	15
CO4	Apply the Fatigue Crack Growth principle	25
CO5	Apply the principles of Crack Arrest mechanism	10
CO6	Apply the Numerical methods to predict the crack growth	15

*** Weightage depends on Bloom's Level, number of contact hours,

CO Mapping with CDIO Curriculum Framework

CO #	TCE Proficiency Scale	Learning Domain Level			CDIO Curricular Components (X.Y.Z)
		Cognitive	Affective	Psychomotor	
CO1	TPS2	Understand	Respond	Guided Response	1.2,2.1.1
CO2	TPS3	Apply	Value	Mechanism	1.1.1, 1.2, 1.3 , 2.1.3 ,2.1.4, 2.1.5 , 4. 4.1, 4. 4. 2 , 4.4.3
CO3	TPS2	Understand	Respond	Guided Response	1.2,2.1.1
CO4	TPS3	Apply	Value	Mechanism	1.1.1, 1.2, 1.3 , 2.1.3 ,2.1.4, 2.1.5 , , 4. 4.1, 4. 4. 2 , 4.4.3
CO5	TPS3	Apply	Value	Mechanism	1.1.1, 1.2, 1.3 , 2.1.3 ,2.1.4,

					2.1.5 , , 4. 4.1 , 4. 4. 2 , 4.4.3
CO6	TPS3	Apply	Value	Mechanism	1.1.1, 1.2, 1.3 , 2.1.3 ,2.1.4, 2.1.5 , , 4. 4.1 , 4. 4. 2 , 4.4.3

Mapping with Programme Outcomes and Programme Specific Outcomes

Cos	PO1	PO2	PO3	PO4	PO5	PO6	PO7	PO8	PO9	PO10	PO11	PO12	PSO1	PSO2
CO1	M	L	----	----	----	M	S	M	M	----	M	M	L	M
CO2	S	M	L	----	----	S	S	S	S	----	S	S	M	S
CO3	M	L	----	----	----	M	S	M	M	----	M	M	L	M
CO4	S	M	L	----	----	S	S	S	S	----	S	S	M	S
CO5	S	M	L	----	----	S	S	S	S	----	S	S	M	S
CO6	S	M	L	----	----	S	S	S	S	----	S	S	M	S

S- Strong; M-Medium; L-Low

Assessment Pattern: Cognitive Domain

Cognitive Levels	Continuous Assessment Tests			Assignment			Terminal Examination
	1	2	3	1	2	3	
Remember	10	10	10	-	-	-	10
Understand	10	10	10	-	-	-	10
Apply	80	80	80	100	100	100	80
Analyse				-	-	-	
Evaluate				-	-	-	
Create				-	-	-	-

Assessment Pattern: Psychomotor

Psychomotor Skill	Mini project /Assignment/Practical Component
Perception	-
Set	-
Guided Response	-
Mechanism	Assignment
Complex Overt Responses	-
Adaptation	-
Origination	-

Sample Questions for Course Outcome Assessment**

** (2 to 3 at the cognitive level of course outcome)

Course Outcome1(CO1):

1. What is fracture toughness of a material?
2. What are the modes of fracture?
3. Draw the standard test specimen for KIC testing

Course Outcome2(CO2):

1. What is critical stress intensity factor?
2. What is j integral?
3. What is crack tip plastic zone?

Course Outcome3(CO3):

1. Discuss the situation under which “K” approach becomes inapplicable.
2. Discuss the Stresses due to elliptical hole in a plate.
3. Explain Brittle to ductile transition in steel

Course Outcome 4 (CO4):

1. Determine the energy release rate for an edge crack loaded as shown in fig.1

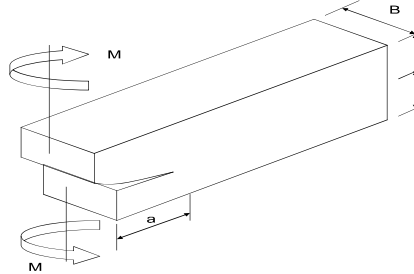

Figure 1

2. By using Westergaard approach evaluate the stresses in the vicinity of crack tip.
3. Explain how is the small scale yielding at the crack tip is taken care by Irwin. Illustrate its physical significance.

Course Outcome 5 (CO5):

1. What are the requirements for the crack to advance by R curve concept?
2. Explain J integral and Crack growth Resistance curves for ductile and brittle materials
3. Why does the Compliance of the component increases with the growth of a crack?

Course Outcome6(CO6):

1. Determine the energy release rate of DCB specimen through the change in strain energy approach for constant load.
2. Discuss elastic and Visco elastic behavior of steel and explain plastic deformation process of steel.
3. Draw a neat sketch of CT and SENB specimen as per ASTM Standard and explain the method of precracking in these specimens.

Concept Map

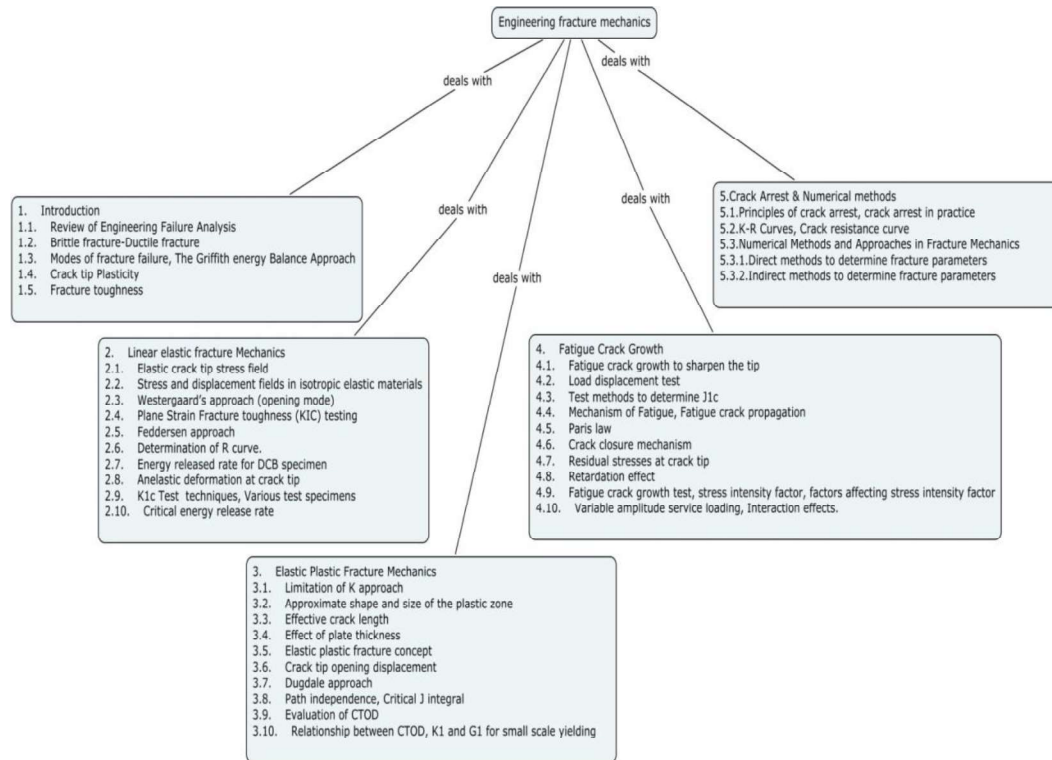

Syllabus

Introduction-Review of Engineering Failure Analysis-Brittle fracture-Ductile fracture, Modes of fracture failure, The Griffith energy Balance Approach-Crack tip Plasticity-Fracture toughness
Linear elastic fracture Mechanics-Elastic crack tip stress field Stress and displacement fields in isotropic elastic materials-Westergaard's approach (opening mode)-Plane Strain Fracture toughness (KIC) testing-Feddersen approach, Determination of R curve, Energy released rate for DCB specimen-An elastic deformation at crack tip-K_{1c} Test techniques, Various test specimens-Critical energy release rate
Elastic Plastic Fracture Mechanics-Limitation of K approach -Approximate shape and size of the plastic zone-Effective crack length-Effect of plate thickness-Elastic plastic fracture concept-Crack tip opening displacement-Dugdale approach-Path independence, Critical J integral-Evaluation of CTOD-Relationship between CTOD, K₁ and G₁ for small scale yielding
Fatigue Crack Growth-Fatigue crack growth to sharpen the tip, SN curve-methods to determine J_{1c}Mechanism of Fatigue, Fatigue crack propagation-Paris law-Crack closure mechanism-Residual stresses at crack tip-Retardation effect fatigue crack growth test, stress intensity factor, factors affecting stress intensity factor-Variable amplitude service loading, Interaction effects
Crack Arrest & Numerical methods Principles of crack arrest, crack arrest in practice-R Curves, Crack resistance curve, Eutectic process Numerical Methods and Approaches in Fracture Mechanics, Direct methods to determine fracture parameters Indirect methods to determine fracture parameters

Learning Resources

1. John M. Barson & Stanely T. Rolfe, "Fracture and Fatigue Control in Structure," Prentice Hall Inc, USA, 1987.
2. David Broek, "Elementary Engineering Fracture Mechanics," MartinusNijhoff Publishers, The Hague, 1982.
3. Jean Lemaitre & Jean Louis Chaboche, "Mechanics of Solid Materials," Cambridge University Press, Cambridge, 1987.

4. Gdoutos E. E., "Fracture Mechanics – An introduction," Kluwer Academic publishers, Dordrecht, 1993.
5. Knott J. F., "Fundamentals of Fracture Mechanics," John Wiley & Sons, New York 1973.
6. Suresh S., "Fatigue of Materials," Cambridge University Press, Cambridge 1991.
7. Bhushan L. Karihaloo, "Fracture Mechanics and Structural Concrete," Longman Scientific Publishers, USA, 1972.
8. Simha K. R. Y., "Fracture Mechanics for Modern Engineering Design," University Press (India) Ltd, Hyderabad, 2001.

Course Contents and Lecture Schedule

Module No.	Topic	No. of Hours	Course Outcome
1.0	Introduction		
1.1	Review of Engineering Failure Analysis	1	CO1
1.2	English Stress concentration factors	1	CO1
1.3	Brittle fracture-Ductile fracture	2	CO1
1.4	Modes of fracture failure	1	CO1
1.5	The Griffith energy Balance Approach	1	CO1
1.6	Crack tip Plasticity, Fracture toughness	1	CO1
2.0	Linear Elastic Fracture Mechanics		
2.1	Elastic crack tip stress field	1	CO2
2.2	Stress and displacement fields in isotropic elastic materials	1	CO2
2.3	Westergaard's approach (opening mode)	1	CO2
2.4	Plane Strain Fracture toughness (K _{IC}) testing	1	CO2
2.5	Feddersen approach, Determination of R curve.	1	CO2
2.6	Energy released rate for DCB specimen	1	CO2
2.7	Anelastic deformation at crack tip	1	CO2
2.8	K _{1c} Test techniques, Various test specimens	1	CO2
2.9	Critical energy release rate	1	CO2
3.0	Elastic Plastic Fracture Mechanics		
3.1	limitation of K approach	1	CO3
3.2	Approximate shape and size of the plastic zone	1	CO3
3.3	Effective crack length	1	CO3
3.4	Effect of plate thickness	1	CO3
3.5	Elastic plastic fracture concept	1	CO3
3.6	Crack tip opening displacement	1	CO3
3.7	Dugdale approach	1	CO3
3.8	Path independence, Critical J integral	1	CO3
3.9	Evaluation of CTOD	1	CO3
3.10	Relationship between CTOD, K ₁ and G ₁ for small scale yielding	1	CO3
4.0	Fatigue Crack Growth		
4.1	Paris law-Crack closure mechanism	2	CO4
4.2	Retardation effect fatigue crack growth test	1	CO4
4.3	Variable amplitude service loading, Interaction effects	1	CO4
5.0	Crack Arrest & Numerical methods		
5.1	Principles of crack arrest, crack arrest in practice	1	CO5
5.2	K-R Curves, Crack resistance curve	1	CO5

5.3	Numerical Methods and Approaches in Fracture Mechanics	2	CO6
5.4	Direct methods to determine fracture parameters	1	CO6
5.5	Indirect methods to determine fracture parameters	1	CO6
Total		36	

Course Designers:

1. Dr.R.Ponnudurai rpdcivil@tce.edu

18CEPF0	INSTRUMENTATION IN CIVIL ENGINEERING				
	Category	L	T	P	Credit
	PE	3	0	0	3

Preamble

This course deals with the various instruments that are used in civil engineering and to expose the students about the significance of measurements and applications. At the end of the course the students will be able to acquire knowledge on various types of measuring instruments used in civil Engineering, understand the principle of operation of measuring instruments, explain the operation of instruments related to static and dynamic measurements, understand the principle of operation of structural measuring instruments.

Prerequisite

Physics

Course Outcomes

On the successful completion of the course students will be able to

CO Number	Course Outcome Statement	Weightage*** in %
CO1	Understand the basic circuits for measuring instruments	15
CO2	apply the instrument techniques which is suited for structural related problem in civil engineering	15
CO3	apply seismic instruments for measuring the motion of vibration in structures	25
CO4	Understand the environmental problems using various measuring instruments	15
CO5	understand the principle and usage of flow meters in flow measurements	15
CO6	apply various NDT techniques in solving practical structural engineering problems	15

*** Weightage depends on Bloom's Level, number of contact hours,

CO Mapping with CDIO Curriculum Framework

CO #	TCE Proficiency Scale	Learning Domain Level			CDIO Curricular Components (X.Y.Z)
		Cognitive	Affective	Psychomotor	
CO1	TPS2	Understand	Respond	Guided Response	1.2,2.1.1
CO2	TPS3	Apply	Value	Mechanism	1.1.1, 1.2, 1.3, 2.1.3, 2.1.4, 2.1.5, 4.4.1, 4.4.2, 4.4.3
CO3	TPS3	Apply	Value	Mechanism	1.1.1, 1.2, 1.3, 2.1.3, 2.1.4, 2.1.5, 4.4.1, 4.4.2, 4.4.3
CO4	TPS2	Understand	Respond	Guided Response	1.1.1, 1.2, 1.3, 2.1.3, 2.1.4, 2.1.5, 4.4.1, 4.4.2, 4.4.3
CO5	TPS3	Apply	Value	Mechanism	1.1.1, 1.2, 1.3, 2.1.3, 2.1.4, 2.1.5, 4.4.1, 4.4.2, 4.4.3
CO6	TPS3	Apply	Value	Mechanism	1.1.1, 1.2, 1.3, 2.1.3, 2.1.4,

					2.1.5 , , 4. 4.1 , 4. 4. 2 , 4.4.3
--	--	--	--	--	------------------------------------

Mapping with Programme Outcomes and Programme Specific Outcomes

Cos	PO1	PO2	PO3	PO4	PO5	PO6	PO7	PO8	PO9	PO10	PO11	PO12	PSO1	PSO2
CO1	M	L	----	----	----	M	S	M	M	----	M	M	L	M
CO2	S	M	L	----	----	S	S	S	S	----	S	S	M	S
CO3	S	M	L	----	----	S	----	S	S	----	S	S	M	S
CO4	M	L	----	----	----	M	S	M	M	----	M	M	L	M
CO5	S	M	L	----	----	S	S	S	S	----	S	S	M	S
CO6	S	M	L	----	----	S	S	S	S	----	S	S	M	S

S- Strong; M-Medium; L-Low

Assessment Pattern: Cognitive Domain

Cognitive Levels	Continuous Assessment Tests			Assignment			Terminal Examination
	1	2	3	1	2	3	
Remember	15	15	15	-	-	-	15
Understand	15	15	15	-	-	-	15
Apply	70	70	70	100	100	100	70
Analyse				-	-	-	
Evaluate				-	-	-	
Create				-	-	-	

Assessment Pattern: Psychomotor

Psychomotor Skill	Mini project /Assignment/Practical Component
Perception	-
Set	-
Guided Response	-
Mechanism	Assignment
Complex Overt Responses	-
Adaptation	-
Origination	-

Sample Questions for Course Outcome Assessment**

** (2 to 3 at the cognitive level of course outcome)

Course Outcome 1 (CO1):

1. Differentiate between Active and Passive types of instrument with examples?
2. What is resolution of an instrument?
3. Explain any five types of Instruments with examples?

Course Outcome 2 (CO2):

1. What do you understand by the term transducer, how are they classified?
2. Why electrical transducers are more popular as secondary transducers over the mechanical type?
3. Explain the principle of operation of piezoelectric transducers. Why their use is limited to the measurement of dynamic quantities only?

Course Outcome 3 (CO3):

1. Explain with a neat sketch the principle of working of a pneumatic or hydraulic load cell for the measurement of force.
2. How are the elastic transducers used for the measurement of force? What secondary transducers are generally employed with elastic transducer?
3. What is a proving ring and why is it named so? How can it be used to measure force.

Course Outcome 4 (CO4):

1. Enumerate and explain the various methods for the measurement of velocity of flow at a point.
2. Sketch and explain the principle of working of,
 - (i) Turbine flow meter
 - (ii) Electromagnetic flow meter.
3. Discuss the constant current and constant temperature mode of operation.

Course Outcome 5 (CO5):

1. Discuss the constant current and constant temperature mode of operation.
2. How the anemometer measuring the flow of liquids differs from that used for gases.
3. Sketch and explain the principle of working of a hot wire anemometer.

Course Outcome 6 (CO6):

1. Explain the principle of operation of Impact Echo method
2. Brief how Ground penetrating Radar helps to investigate the failures
3. Explain how cracks are determined by using Radiographic testing

Concept Map

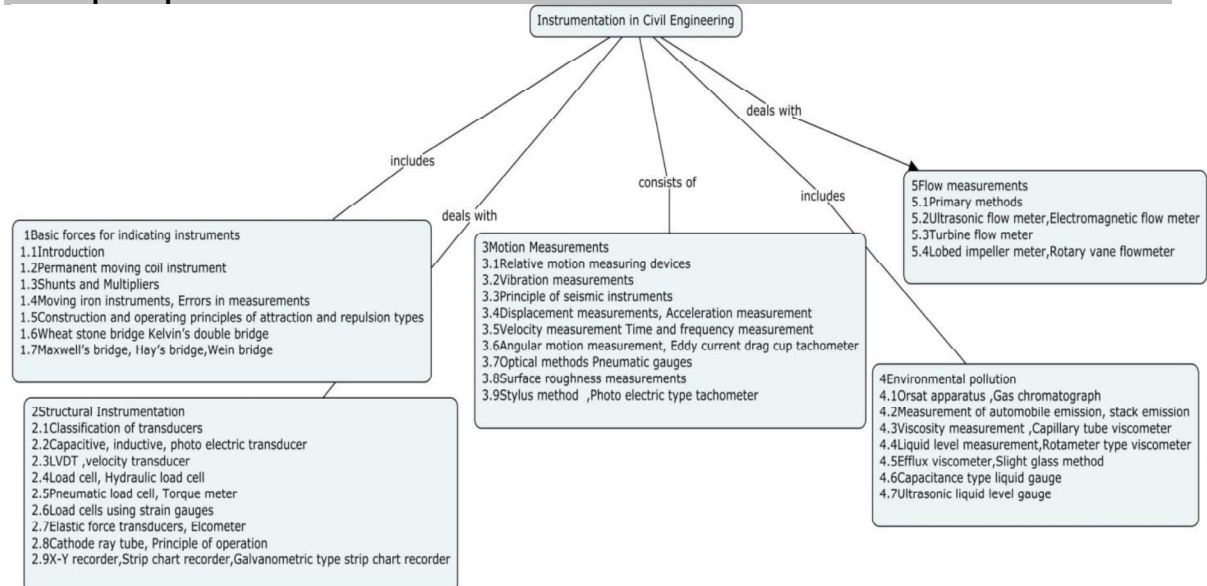

Syllabus

Basic forces for indicating instruments-Introduction - Permanent moving coil instrument-Shunts and Multipliers - Wheat stone bridge Kelvin's double bridge - Maxwell's bridge, Hay's bridge, Wein bridge - **Structural Instrumentation** - Classification of transducers - Capacitive, inductive, photo electric transducer - LVDT ,velocity transducer - Load cell, Hydraulic load cell - Pneumatic load cell, Torque meter - Load cells using strain gauges - Elastic force transducers, Elcometer - Cathode ray tube, Principle of operation - X-Y recorder, Strip chart recorder, Galvanometric type strip chart recorder - **Motion Measurements** - Relative motion measuring devices - Vibration measurements - Principle of seismic instruments - Displacement measurements, Acceleration measurement - Velocity measurement Time and frequency measurement - Angular motion measurement, Eddy current drag cup tachometer - Optical methods Pneumatic gauges - Surface roughness measurements **Environmental pollution**-Orsat apparatus ,Gas chromatograph - Measurement of automobile emission, stack emission - Viscosity measurement ,Capillary tube viscometer - Liquid level measurement, Rotameter type viscometer - Efflux viscometer, Slight glass method - Capacitance type liquid gauge - Ultrasonic liquid level gauge- **Flow measurements**- Primary methods - Ultrasonic flow meter, Electromagnetic flow meter - Turbine flow meter - Lobed impeller meter, Rotary vane flowmeter. **NDT Methods** - Load testing on bridges , towers- Rebound hammer method , Ultra sonic pulse velocity technique- X-ray method, Gamma ray method- Corrosion measurements - linear polarization resistance- Rapid chloride ion penetration test.

Learning Resources

1. Keith Cheatele, "Fundamentals of Test Measurement Instrumentation", ISA publishers, 2004.
2. Michael D. Whitt, "Successful Instrumentation and Control systems design with CD", ISA publishers, 2004.
3. Jim Strothman, "ISA Handbook of Measurement Equations and Tables", 2nd Edition, ISA publishers, 2006.
4. Gregory K. McMillan and Robert A. Cameron, "Advanced pH Measurement and Control", 3rd Edition, ISA publishers, 2005.

Course Contents and Lecture Schedule

Module No.	Topic	No. of Hours	Course Outcome
1	Basic forces for indicating instruments		
1.1	Introduction	1	CO1
1.2	Permanent moving coil instrument		CO1
1.3	Shunts and Multipliers	1	CO1
1.4	Wheat stone bridge Kelvin's double bridge	1	CO1
1.5	Maxwell's bridge, Hay's bridge, Wein bridge	1	CO1
2	Structural Instrumentation		
2.1	Classification of transducers	1	CO2
2.2	Capacitive, inductive, photo electric transducer	1	CO2
2.3	LVDT ,velocity transducer	1	CO2
2.4	Load cell, Hydraulic load cell	1	CO2
2.5	Pneumatic load cell, Torque meter	1	CO2
2.6	Load cells using strain gauges	1	CO2
2.7	Elastic force transducers, Elcometer	1	CO2
2.8	Cathode ray tube, Principle of operation	1	CO2
2.9	X-Y recorder, Strip chart recorder, Galvanometric type strip	1	CO2

	chart recorder		
3	Motion Measurements		
3.1	Relative motion measuring devices	1	CO3
3.2	Vibration measurements	1	CO3
3.3	Principle of seismic instruments	1	CO3
3.4	Displacement measurements, Acceleration measurement	1	CO3
3.5	Velocity measurement Time and frequency measurement	1	CO3
3.6	Angular motion measurement, Eddy current drag cup tachometer	1	CO3
3.7	Optical methods Pneumatic gauges	1	CO3
3.8	Surface roughness measurements	1	CO3
4	Environmental pollution		
4.1	Orsat apparatus ,Gas chromatograph	1	CO4
4.2	Measurement of automobile emission, stack emission	1	CO4
4.3	Viscosity measurement ,Capillary tube viscometer	1	CO4
4.4	Liquid level measurement,Rotameter type viscometer	1	CO4
4.5	Efflux viscometer,Slight glass method	1	CO4
4.6	Capacitance type liquid gauge	1	CO4
4.7	Ultrasonic liquid level gauge	1	CO4
5	Flow measurements		
5.1	Primary methods	1	CO5
5.2	Ultrasonic flow meter,Electromagnetic flow meter	1	CO5
5.3	Turbine flow meter	1	CO5
5.4	Lobed impeller meter,Rotary vane flowmeter	1	CO5
6	NDT Methods		
6.1	Rebound hammer method ,Ultra sonic pulse velocity technique	1	CO6
6.2	X-ray method, Gamma ray method	1	CO6
6.3	Corrosion measurements - linear polarization resistance	1	CO6
6.4	Rapid chloride ion penetration test	1	CO6

Course Designers:

1. Dr. R.Ponnudurai rpdcciv@tce.edu

18CEPG0	DESIGN OF REINFORCED CONCRETE SPECIAL STRUCTURES				
	Category	L	T	P	Credit
	PE	3	0	0	3

Preamble

The extensive use of reinforced concrete for a variety of structural members has necessitated a proper understanding of the design in structural concrete members by the structural engineers. This course offers analysis and design of reinforced concrete structures like deep beams, corbels, curved beams, shear wall, bunkers and silos, virendeel girders, poles, pipes, formworks and concrete trusses as per IS specifications. It also aims at determination of safe as well as economical sections and their reinforcement under various types of loading. At the end of the course, student has a comprehensive design knowledge related to structures and systems that are likely to be encountered in professional practice.

Prerequisite

18CE610 Design of Reinforced Concrete Elements

Course Outcomes

On the successful completion of the course students will be able to

CO Number	Course Outcome Statement	Weightage*** in %
CO1	Design special elements such as deep beams, corbels and curved beams and detail the reinforcement	20
CO2	Design special elements such as shear wall and bunkers and silos and detail the reinforcement	20
CO3	Design special elements such as Virendeel girders and poles and detail the reinforcement	15
CO4	Design reinforced concrete pipes under various types of loading and detail the reinforcement	15
CO5	Design formworks for column, beam and floor slab and detail the reinforcement	15
CO6	Analyse and design the concrete trusses and detail the reinforcement	15

*** Weightage depends on Bloom's Level, number of contact hours,

CO Mapping with CDIO Curriculum Framework

CO #	TCE Proficiency Scale	Learning Domain Level			CDIO Curricular Components (X.Y.Z)
		Cognitive	Affective	Psychomotor	
CO1	TPS3	Apply	Value	Mechanism	1.1.1, 2.1.1
CO2	TPS3	Apply	Value	Mechanism	1.1.1, 1.2, 1.3, 2.1.4, 2.1.5, 3.2.3
CO3	TPS3	Apply	Value	Mechanism	1.1.1, 1.2, 1.3, 2.1.5, 2.4.4.

CO4	TPS3	Apply	Value	Mechanism	1.1.1, 1.2,1.3, 2.1.4
CO5	TPS3	Apply	Value	Mechanism	1.1.1, 1.2,1.3, 2.4.4
CO6	TPS3	Apply	Value	Mechanism	1.1.1, 1.2,1.3,2.4.3

Mapping with Programme Outcomes and Programme Specific Outcomes

COS	PO1	PO2	PO3	PO4	PO5	PO6	PO7	PO8	PO9	PO10	PO11	PO12	PSO1	PSO2
CO1	S	M	L	----	---	S	M	S	S	---	S	S	M	M
CO2	S	M	L	----	---	S	M	S	S	---	S	S	M	M
CO3	S	M	L	----	---	S	M	S	S	---	S	S	M	M
CO4	S	M	L	----	---	S	M	S	S	---	S	S	M	M
CO5	S	M	L	----	---	S	M	S	S	---	S	S	M	M
CO6	S	M	L	----	---	S	M	S	S	---	S	S	M	M

S- Strong; M-Medium; L-Low

Assessment Pattern: Cognitive Domain

Cognitive Levels	Continuous Assessment Tests			Assignment			Terminal Examination
	1	2	3	1	2	3	
Remember	10	10	10	-	-	-	10
Understand	10	10	10	-	-	-	10
Apply	80	80	80	100	100	100	80
Analyse							
Evaluate							
Create							

Assessment Pattern: Psychomotor

Psychomotor Skill	Assignment
Perception	-
Set	-
Guided Response	50
Mechanism	50
Complex Overt Responses	-
Adaptation	-
Origination	-

Sample Questions for Course Outcome Assessment**

Course Outcome 1 (CO1):

1. Define the term: Deep beam.
2. Make use of M25 and Fe415 as materials, design the reinforcement required for a single span deep beam having effective span = 8m; Overall depth = 7m; Width of support = 0.45m; Width of beam = 0.45m; Total load on beam including self weight = 550 kN/m; Draw the reinforcement details of the beam.
3. Analyse and design a corbel for a 350mm square column to support an ultimate vertical load of 600kN with its Line of action 200mm from the face of the column. Use M20 grade concrete and Fe 415 grade steel. Sketch the reinforcement details.

Course Outcome 2 (CO2):

1. What are the differences between bunkers and silos?
2. Make use of limit state method; design a circular cylindrical bunker to store 20 tonnes of coal. Density of coal is 9 kN/m³. Angle of repose is 30 degrees. Use M20 and Fe415 as materials. Sketch the reinforcement details of bunker.
3. A plain traced concrete wall of dimensions 8 m high, 6 m long and 200 mm thick is restrained against rotation at its base and unrestrained at the ends. If it has to carry a factored total gravity load of 200 kN and a factored horizontal load of 8 kN at top. Check the safety of the wall. Assume M25 and Fe500. Draw the reinforcement details.

Course Outcome 3 (CO3):

1. What are the different methods adopted for the analysis of virendeel girders?
2. A virendeel girder of 9m has 3 bays of 3m each. The height of the verticals is 3m. The girder supports concentrated loads of 100 kN and 50 kN at the interior node points of the top dome. Assuming constant stiffness for the members, compute the moments forces in the girder.
3. A reinforced concrete pole 10m long is required to carry 4 conductors of 7mm diameter each spaced at 500mm intervals in a cross arm fixed at 600mm from the top. The depth of embedment is 1.8m, below ground level. Spacing of poles is 50m. Wind pressure is 1.5 kN/m². Load factor is 2.5. Tension in conduction is 3 kN. Make use of M20 and Fe415 as materials design suitable pole for the transmission line.

Course Outcome 4 (CO4):

1. What are the classifications of pipes?
2. Make use of permissible stress in concrete and steel of 2.8 N/mm² and 150 N/mm² respectively, design a pipe against hoop tension having internal diameter of 1750mm and is subjected to a water pressure of 13m of head of water. Assume the pipe is supported at GL at its horizontal diameter.
3. A reinforced concrete pressure pipe is to be designed to withstand a working pressure of 0.2 kN/m². The internal diameter of the pipe is 1000mm and the length of the pipe is 3m. Make use of M20 and hard drawn steel wire conforming to IS 432 as materials design the pipe and sketch the details of reinforcements.

Course Outcome 5 (CO5):

1. Draw the cross section and sectional elevation of formworks for column and beam and slab and its shuttering details.
2. Make use of IS codal provisions, design the formwork for the slab floor only for the following data: Thickness of floor = 125mm; Centre to centre spacing of beams = 3.5m; Width of beam = 250mm; Take a live load on sheathing = 3 kN/m²; weight of wet concrete as 28.5 kN/m³.

3. Make use of IS codal provisions, design the formwork for a column 230mm x 230mm, having a height of 1.2. It is proposed to pour the entire concrete in one stage.

Course Outcome 6 (CO6):

1. Draw the cross section of various types of concrete trusses.
2. Explain the analysis of trusses.
3. Make use of M20 and Fe415 as materials; design a reinforced concrete fink type truss to suit the following data. Span of truss: 25m. Spacing of trusses: 5m. Central rise of truss: 4.13m. It is used to support concrete purlins at intervals of 1.35m and asbestos sheets cover roof. Sketch the details of reinforcement details of members of truss.

Concept Map

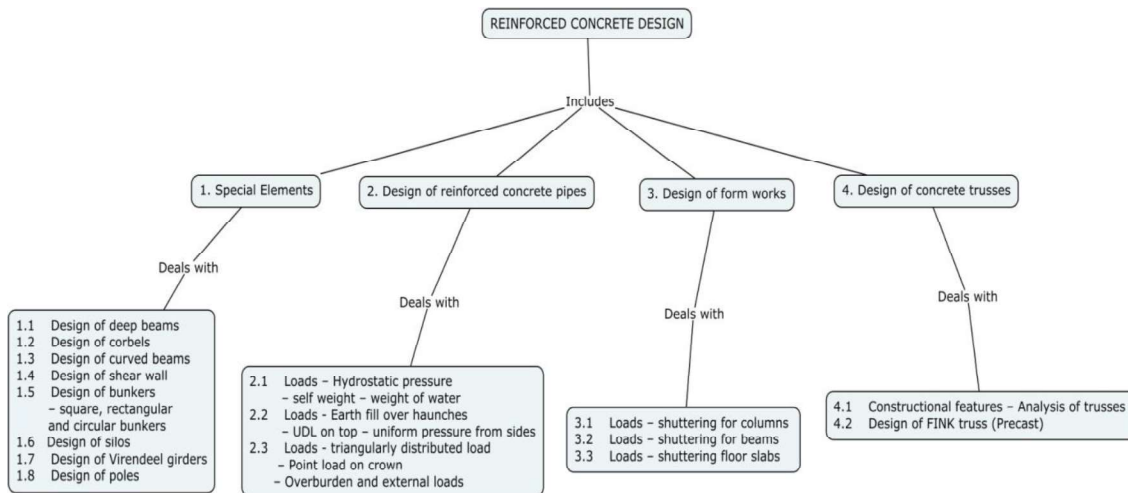

Syllabus

Design of Special Elements: Deep beams, corbels, curved beams, shear wall, bunkers – square, rectangular and circular bunkers; silos, vierendeel girders and poles; Reinforcement detailing. **Design of reinforced concrete pipes:** Under hydrostatic pressure, self weight, weight of water, earth fill over haunches, UDL on top, uniform pressure from sides, triangularly distributed load, point load on crown, Overburden and external loads; Reinforcement detailing. **Design of form works:** Shuttering for columns, beams and floor slabs; Detailing of form works. **Design of concrete trusses:** Constructional features, analysis of trusses, design of FINK truss (Precast); Reinforcement detailing.

Learning Resources

1. N. Krishna Raju Advanced Reinforced Concrete Design IS 456-2000, CBS Publishers and Distributors, New Delhi, 2016.
2. P.C. Varghese, Advanced Reinforced Concrete Design, Prentice Hall of India, Pvt. Ltd., New Delhi, 2013.
3. M.L. Gambhir, Design of Reinforced Concrete structures, Prentice Hall of India Private limited, New Delhi, 2012.
4. N. Subramanian, Design of Reinforced Concrete Structures, Oxford University Press, New Delhi, 2014.
5. B.C. Punmia, Ashok Kumar Jain and Arun Kumar Jain, RCC Designs (Reinforced Concrete Structures), Laxmi Publications Pvt. Ltd., New Delhi, 2015.
6. Self learning materials – online courses - <http://nptel.ac.in/courses/105105104/20>

IS Codes

1. IS 456:2000 Plain and Reinforced Concrete – Code of Practice.
2. IS 875(1-2):1987 Code of Practice for Design Loads (Other than Earthquake) for Buildings and Structures.
3. IS 875(3):2015 Code of Practice for Design Loads (Other than Earthquake) for Buildings and Structures
4. IS 875(4-5):1987 Code of Practice for Design Loads (Other than Earthquake) for Buildings and Structures
5. IS 485: 2003 Precast concrete pipes (with and without reinforcement) – Specification
6. IS 783: 1985 Code of practice for laying of concrete pipes
7. IS 3201: 1988 Criteria for design and construction of precast concrete trusses and purlins
8. IS 4995: 1974 Criteria for design of reinforced concrete bins for the storage of granular and powdery materials
 - a. Part I: General requirements and assessment of bin loads
 - b. Part II: Design Criteria
9. IS 785: 1998 Reinforced concrete poles for overhead tower and telecommunication lines – Specification.
10. SP 16:1980 Design Aids for Reinforced Concrete to IS 456:1978.
11. SP 34:1987 Handbook of concrete reinforcement and detailing

Course Contents and Lecture Schedule – Theory Part			
Module No.	Topics	No of Lectures	Course Outcomes
1.0	Design of Special Elements		
1.1	Deep beams and its reinforcement detailing	2	CO1
1.2	Corbels and its reinforcement detailing	2	CO1
1.3	Curved beams and its reinforcement detailing	2	CO1
1.4	Shear wall and its reinforcement detailing	2	CO2
1.5	Bunkers – square and its reinforcement detailing	2	CO2
1.6	Bunkers –rectangular and circular and its reinforcement detailing	2	CO2
1.7	Silos and its reinforcement detailing	2	CO2
1.8	Virendeel girders and its reinforcement detailing	2	CO3
1.9	Poles and its reinforcement detailing	2	CO3
2.0	Design of reinforced concrete pipes		
2.1	Under Hydrostatic pressure, self weight and weight of water - reinforcement detailing	2	CO4
2.2	Under Earth fill over haunches, UDL on top and uniform pressure from sides - reinforcement detailing	2	CO4

2.3	Under triangularly distributed load, point load on crown, overburden and external loads - reinforcement detailing	2	CO4
3.0	Design of form works		
3.1	Shuttering for columns and its detailing	2	CO5
3.2	Shuttering for beams and its detailing	2	CO5
3.3	Shuttering floor slabs and its detailing	2	CO5
4.0	Design of concrete trusses		
4.1	Constructional features and analysis of trusses	2	CO6
4.2	Design principles of concrete truss	2	CO6
4.3	Design of FINK truss (Precast) and its reinforcement detailing	2	CO6
	TOTAL	36	

Course Designers:

1. Dr.M.C.Sundarraja mcsciv@tce.edu
2. R. Sankaranarayanan rsciv@tce.edu

18CEPH0	MUNICIPAL SOLID WASTE MANAGEMENT				
	Category	L	T	P	Credit
	PE	3	0	0	3

Preamble

Solid waste management has been one of the significant issues to be addressed by the urban local body which is responsible for providing basic service to the people. Due to the rapid urbanisation it is difficult to manage the huge quantity of waste generated from the community. So it is necessary and atmost priority to provide a viable solution to tackle the challenge. This course provides an in-depth understanding of solid waste characteristics and management. The students acquire proficiency in processing and safe disposal of municipal solid waste generated by a community.

Prerequisite

NIL

Course Outcomes

On the successful completion of the course students will be able to

CO Number	Course Outcome Statement	Weightage*** in %
CO1	Explain the various functional elements involved in solid waste management system	10
CO2	Quantify and classify the solid wastes generated from a community.	20
CO3	Analyze the collection route and collection system	15
CO4	Select suitable waste processing technologies and disposal methods	25
CO5	Analyse the options to recover energy from waste generated	15
CO6	Design a suitable sanitary landfill for disposal of solid waste on land	15

*** Weightage depends on Bloom's Level, number of contact hours,

CO Mapping with CDIO Curriculum Framework

CO #	TCE Proficiency Scale	Learning Domain Level			CDIO Curricular Components (X.Y.Z)
		Cognitive	Affective	Psychomotor	
CO 1	TPS2	Understand	Response	Guided Response	1.1,2.3.1,2.3.2,3.2.1,4.1.6
CO 2	TPS2	Understand	Response	Guided Response	1.1,2.3.1,2.3.2,3.2.1,4.1.6
CO 3	TPS3	Apply	Value	Mechanisms	1.1.1,2.3.2,2.4.4,2.4.7,3.2.1,4.3.4,4.4.5
CO 4	TPS3	Apply	Value	Mechanisms	1.1.1,2.3.2,2.4.4,2.4.7,3.2.1,4.3.4,4.4.5
CO 5	TPS3	Apply	Value	Mechanisms	1.1.1,2.3.2,2.4.4,2.4.7,3.2.1,4.3.4,4.4.5
CO 6	TPS3	Apply	Value	Mechanisms	1.1.1,2.3.2,2.4.4,2.4.7,3.2.1,4.3.4,4.4.5

Mapping with Programme Outcomes and Programme Specific Outcomes

Cos	PO1	PO2	PO3	PO4	PO5	PO6	PO7	PO8	PO9	PO10	PO11	PO12	PSO1	PSO2
CO 1	M	L	-	-	-	M	M	L	L	L	L	L	M	L
CO 2	M	L	-	-	-	M	M	L	L	L	L	L	M	L
CO 3	S	M	L	-	-	M	S	M	M	L	M	L	M	L
CO 4	S	M	L	-	-	M	S	M	M	L	M	L	M	L
CO 5	S	M	L	-	-	M	S	M	M	L	M	L	M	L
CO 6	S	M	L	-	-	M	S	M	M	L	M	L	M	L

S- Strong; M-Medium; L-Low

Assessment Pattern: Cognitive Domain

Cognitive Levels	Continuous Assessment Tests			Assignment			Terminal Examination
	1	2	3	1	2	3	
Remember	12	12	12	-	-	-	12
Understand	48	48	48	-	-	-	48
Apply	40	40	40	10	10	10	40
Analyse							
Evaluate							
Create							

Assessment Pattern: Psychomotor

Psychomotor Skill	Mini project/Assignment/Practical Component
Perception	-
Set	-
Guided Response	50
Mechanism	50
Complex Overt Responses	-
Adaptation	-
Origination	-

Sample Questions for Course Outcome Assessment**

** (2 to 3 at the cognitive level of course outcome)

Course Outcome1(CO1):

1. List the essential functional elements in MSW.
2. Explain the concept of Integrated Solid Waste Management?

Course Outcome2(CO2):

1. Describe the sampling procedure for the characterisation of the solid waste.
2. List the chemical characteristics of Municipal Solid Waste.

Course Outcome3(CO3):

1. State the factors to be considered while finalizing the collection route.
2. Write down the factors influencing the selection of location for transfer station.
3. List and discuss the types of containers and collection vehicles used for solid waste management.

Course Outcome 4 (CO4):

1. Composting is a sustainable option for biodegradable solid waste-Justify.

2. Compare the environmental effects of composting and bio-gasification.

Course Outcome 5 (CO5):

1. Assess the energy generation potential of MSW.
2. Assess the techno-economic viability of thermal processing techniques.

Course Outcome6(CO6):

1. Suggest the best disposal option for the municipal solid waste generated from your locality.
2. Discuss the various issues faced by municipal authorities in identifying the disposal site.
3. Do you think a sanitary landfill is possible to manage wastes in your locality? List at least three reasons to support your answer.

Concept Map

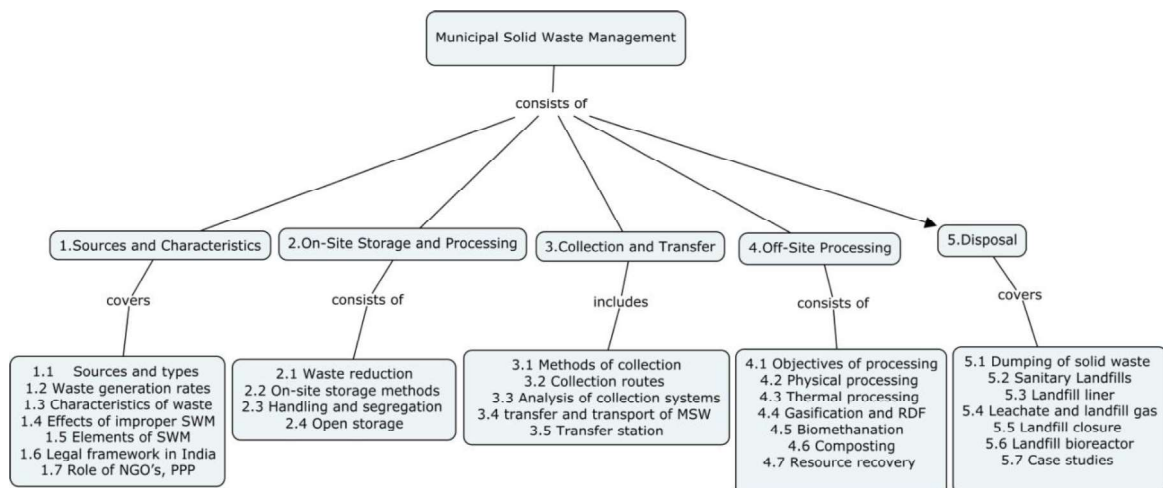

Syllabus

Sources and Characteristics: Sources and types of solid waste; Waste generation rates and factors affecting generation; Method of sampling and characteristics of waste; Effects of improper Solid Waste Management; Elements of Solid Waste Management; Legal framework for Solid Waste Management in India; Integrated Solid Waste Management. **On-Site Storage and Processing:** Source reduction of waste and 3 R's concept for waste reduction; On-site storage methods and materials used for containers; Handling and segregation of waste at source; Public health and economic aspects of open storage. **Collection and Transfer:** Methods of collection of waste; Collection vehicles, manpower and collection routes & their optimization; Analysis of collection systems; Need for transfer and transport of MSW; Transfer station- Selection of location, operation and maintenance. **Processing:** Objectives of MSW processing; Physical processing techniques and equipment; Thermal processing options; Biological conversion technologies; Resource recovery from solid waste- Case studies on Indian conditions. **Disposal:** Dumping of solid waste and its effects on environment; Sanitary Landfills-site selection; Design and Operation- Landfill liner; Management of leachate and landfill gas; Landfill closure and environmental monitoring; Landfill bioreactor; Dumpsite rehabilitation; Case studies on developed and developing countries.

Learning Resources

1. George Tchobanoglous, Hilary Thiesen and Samuel A Vigil, "Integrated Solid Waste Management: Engineering Principles and Management Issues", McGraw Hill Publishers, New York, 1993.

2. "Manual on Municipal Solid Waste Management", CPHEEO, Ministry of Urban Development, Government of India, New Delhi, 2000.
3. Bhide, A. D. and Sundaresan, B. B. "Solid Waste Management Collection, Processing and Disposal", ISBN 81-7525-282-0, 2001.
4. Paul T Williams, "Waste Treatment and Disposal", John Wiley and Sons, England, 2005.
5. Manual on municipal solid waste management, 2016.
6. NPTEL course on Integrated Solid Waste Management for smart cities.
7. NPTEL course on Plastic Waste Management.

Course Contents and Lecture Schedule			
Module No.	Topic	No. of Hours	Course Outcome
1.Sources and Characteristics			
1.1	Sources and types of solid waste	1	CO1
1.2	Waste generation rates and factors affecting generation	1	CO2
1.3	Method of sampling and characteristics of waste	1	CO2
1.4	Effects of improper Solid Waste Management	1	CO2
1.5	Elements of Solid Waste Management	1	CO1
1.6	Legal framework for Solid Waste Management in India	1	CO1
1.7	Integrated Solid Waste Management- Public Awareness and Role of NGO's, PPP	1	CO1
2.On-Site Storage and Processing			
2.1	Source reduction of waste and 3 R's concept for waste reduction	1	CO2
2.2	On-site storage methods and materials used for containers	1	CO2
2.3	Handling and segregation of waste at source	1	CO2
2.4	Public health and economic aspects of open storage	1	CO2
3.Collection and Transfer			
3.1	Methods of collection of waste	1	CO3
3.2	Collection vehicles, manpower and collection routes & their optimization	1	CO3
3.3	Analysis of collection systems	1	CO3
3.4	Need for transfer and transport of MSW	1	CO3
3.5	Transfer station- Selection of location, operation and maintenance	1	CO3
4.Off-Site Processing			
4.1	Objectives of MSW processing	1	CO4
4.2	Physical processing techniques and equipment	2	CO4
4.3	Thermal processing options- Incineration&pyrolysis	2	CO4
4.4	Gasification and RDF	2	CO5
4.5	Biological conversion technologies-Biomethanation	1	CO5
4.6	Composting	1	CO5
4.7	Resource recovery from solid waste- Case studies on Indian conditions	1	CO5
5.Disposal			
5.1	Dumping of solid waste and its effects on environment	2	CO4
5.2	Sanitary Landfills- site selection	1	CO6

5.3	Design and Operation- Landfill liner	2	CO6
5.4	Management of leachate and landfill gas	1	CO6
5.5	Landfill closure and environmental monitoring	1	CO6
5.6	Landfill bioreactor&Dumpsite rehabilitation	1	CO5
5.7	Case studies on developed and developing countries	2	CO4

Course Designers:

1. Dr. V. Ravi Sankar environmentegr@tce.edu

18CEPJ0	Air and Noise Pollution Management
----------------	---

Category	L	T	P	Credit
PE	3	0	0	3

Preamble

This course work offers the basic knowledge on various sources of air pollutants and their possible effects on local, regional and global environment. It provides various techniques for sampling and methods for analysing the pollutants. Also, it deals with the principles and design for control of particulate/gaseous air pollutants and its emerging trends to fulfil the legal aspects of air pollution. In addition, this course imparts knowledge about the fundamental theory of sound, noise pollution sources with its effects and control techniques.

Prerequisite

NIL

Course Outcomes

On the successful completion of the course students will be able to

CO's	Course Outcome Statement	Weightage*** in %
CO1	Identify the sources and effects of air pollution with pollutants sampling techniques and measurements	20
CO2	Show the significance of meteorological factors in dispersion of pollutants and forecast the pollutant concentration at some distance downwind.	20
CO3	Apply suitable preventive and control measures for abatement of air pollution.	20
CO4	Identify suitable locations for citing of industries with appropriate air pollution management strategy.	20
CO5	Identify the sources of noise and its effect on human beings, animals, plants and materials	10
CO6	Produce appropriate noise control measures	10

*** Weightage depends on Bloom's Level, number of contact hours,

CO Mapping with CDIO Curriculum Framework

CO #	TCE Proficiency Scale	Learning Domain Level			CDIO Curricular Components (X.Y.Z)
		Cognitive	Affective	Psychomotor	
CO1	TPS2	Understand	Respond	Guided Response	1.1.3,2.4.2
CO2	TPS3	Apply	Value	Mechanism	1.1.3,1.2.1,2.1.1,2.1.2,2.4.2,2.4.6, 2.5.1, 4.1.1,4.1.3
CO3	TPS3	Apply	Value	Mechanism	1.1.2,1.2.1,2.1.3,2.4.2,2.5.1,4.1.1,4.1.3,4.4.1
CO4	TPS2	Understand	Respond	Guided Response	1.1.2,1.2.3,2.4.2,
CO5	TPS2	Understand	Respond	Guided Response	1.1.2,2.4.2,
CO6	TPS3	Apply	Value	Mechanism	1.1.2,1.2.1,2.1.3,2.4.2,2.5.1,4.1.1,4.1.3,4.4.1

Mapping with Programme Outcomes and Programme Specific Outcomes

CO's	PO	PO	PO	PO	PO	PO	PO	PO	PO	PO	PO1	PO1	PO1	PSO	PSO
------	----	----	----	----	----	----	----	----	----	----	-----	-----	-----	-----	-----

	1	2	3	4	5	6	7	8	9	0	1	2	1	2
CO 1	M	L	-	-	-	L	M	-	-	M	-	-	M	L
CO 2	S	M	L	-	-	S	M	-	L	M	-	-	M	L
CO 3	S	M	L	-	-	L	S	S	L	L	L	S	M	L
CO 4	M	L	-	-	-	S	S	S	S	S	L	S	M	M
CO 5	M	L	-	-	-	M	M	-	M	L	-	-	L	L
CO 6	S	M	L	-	-	L	S	L	L	L	L	S	M	L

S- Strong; M-Medium; L-Low

Assessment Pattern: Cognitive Domain

Cognitive Levels	Continuous Assessment Tests			Assignment			Terminal Examination
	1	2	3	1	2	3	
Remember	20	20	20	-	-	-	20
Understand	60	40	40	100	100	100	40
Apply	20	40	40	-	-	-	40
Analyse							
Evaluate							
Create							

Assessment Pattern: Psychomotor

Psychomotor Skill	Mini project/Assignment/Practical Component
Perception	
Set	
Guided Response	50
Mechanism	50
Complex Overt Responses	
Adaptation	
Origination	

Sample Questions for Course Outcome Assessment**

** (2 to 3 at the cognitive level of course outcome)

Course Outcome1(CO1):

1. Define Air Pollution.
2. Name some Green House Gases.
3. Explain the classification of Air Pollutants.

Course Outcome2(CO2):

1. Define Plume.
2. Demonstrate, how prevailing lapse rate affect the plume behaviour from a stack.
3. Summarize various meteorological factors that affect the transport process of air pollutants.

Course Outcome3(CO3):

1. Explain the working principle of an ESP and state the factors governing its performances.
2. Explain the control strategies in automotive pollution.
3. Identify the various possible source reduction methods in the control of air pollution.

Course Outcome 4 (CO4):

1. Describe master plan of a city.
2. Identify the criteria for citing of industries at a place in a city.
3. Explain the relevance of wind rose diagram for citing of an industry.
4. Illustrate how planning of a city helps in air pollution management.

Course Outcome 5 (CO5):

1. Explain the properties and characteristics of sound.
2. Define noise pollution.
3. Explain the impacts of noise on human beings.

Course Outcome6(CO6):

1. Identify the techniques for abatement of noise in transportation sector.
2. Explain the control methods for reduction of noise from source, path and by receiver.
3. Describe noise preventive measures to be undertaken by an occupational worker.

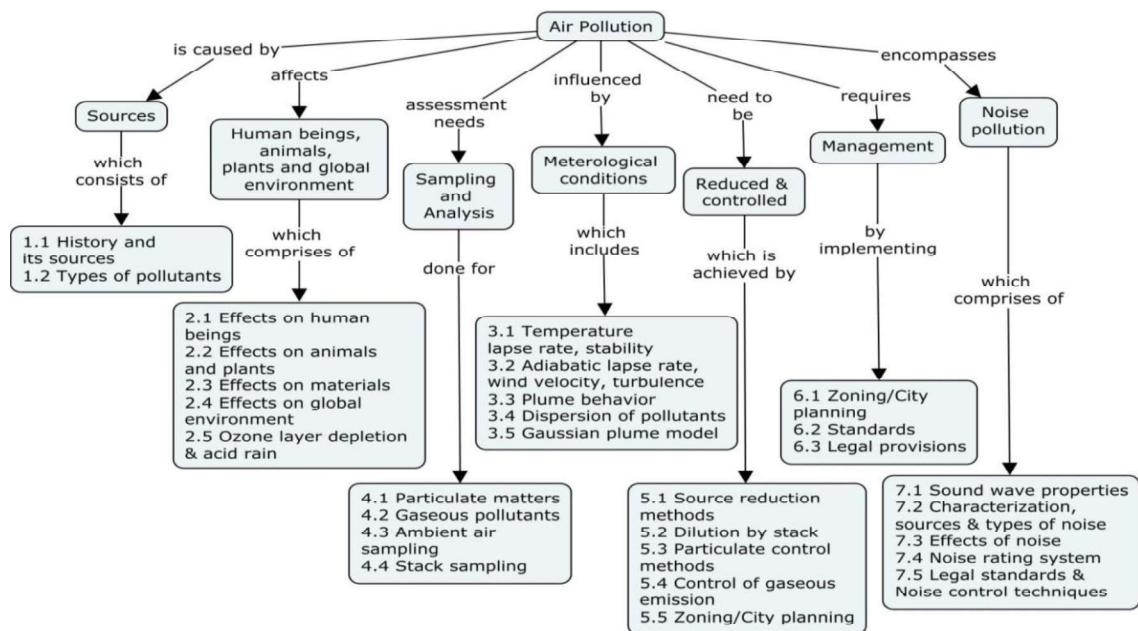
Concept Map**Syllabus**

Introduction to Air pollution– Particulates and Gaseous pollutants - sources, classification and types of air pollutants, Effects and Impacts of Air pollution on environment; Sampling and Analysis techniques. **Meteorological factors** – Dispersion, factors affecting dispersion, Plume rise & behaviour and Modelling techniques; **Reduction and control methods** – source reduction and by equipment control; Automotive pollutions control; **Air pollution management** - Air quality standards, emission standards, indices, industrial plant locations, city planning, air pollution legislation and regulations – air pollution survey; **Noise pollution**– Properties & Characteristics of sound waves; Noise sources, effects; Hearing - mechanism, impairment, speech interference, sleep interference; Noise rating system; Standards for ambient and workspace noise levels, Noise control techniques at source, transmission path & at receiver end.

Learning Resources

1. Noel de Nevers, "Air pollution control engineering", McGraw Hill, New York, 2000.

2. Lawrence K. Wang, Norman C Pererla, Yung – Tse Hung, “Air pollution Control Engineering”, Tokyo, 2004
3. David H.F Liu, BelaG.Liptak “Air pollution”, Lewis publishers, 2000.
4. Rao M.N and Rao H.V.N, “Air pollution”, Tata McGraw Publishers, 2006.
5. Mahajan, S. P., “Air Pollution Control”, TERI Press, New Delhi, 2009.
6. Anjaneyalu Y, “Air pollution and control technologies”, Allied Publishers (P) Ltd. India, 2002.
7. NPTEL courses

Course Contents and Lecture Schedule			
Module No.	Topic	No. of Hours	Course Outcome
1.0	Introduction to Air pollution		
1.1	History of air pollution- Sources of air pollution	1	CO1
1.2	Types of pollutants	1	CO1
2.0	Effects of air pollutants		CO1
2.1	Effects of air pollutants on human beings	2	CO1
2.2	Effects of air pollutants on animals and plants	1	CO1
2.3	Effects of air pollutants on materials	1	CO1
2.4	Effects of air pollutants on global environment – Global warming	1	CO1
2.5	Ozone layer depletion, acid rain	1	CO1
3.0	Sampling and analysis		CO1
3.1	Sampling and measurement of particulate matters	1	CO1
3.2	Sampling and measurement of gaseous matters	1	CO1
3.3	Ambient air sampling, analysis of air pollutants- chemical and instrumental methods	1	CO1
3.4	Stack sampling	1	CO1
4.0	Meteorological conditions		CO2
4.1	Temperature lapse rate, stability	1	CO2
4.2	Adiabatic lapse rate, wind velocity and turbulence	1	CO2
4.3	Plume behaviour	1	CO2
4.4	Dispersion of air pollutants- maximum mixing depth, dispersion model	2	CO2
4.5	Gaussian plume model and plume rise- problems	2	CO2
5.0	Reduction and control methods		
5.1	Source reduction methods	1	CO3
5.2	Dilution by stack	1	CO3
5.3	Control by equipments- Particulate control methods	3	CO3
5.4	Control of gaseous emissions	3	CO3
5.5	Control of automotive pollution	1	CO3
5.6	Review of Journals	1	CO3
6.0	Air pollution management		
6.1	Zoning/City planning, Industrial plant location	1	CO4
6.2	Air quality and emission standards	1	CO4
6.3	Legal provision	1	CO4
7.0	Noise pollution		
7.1	Sound wave properties	1	CO5

7.2	Characteristics, sources & types of noise	1	CO5
7.3	Effects of noise, Noise rating system& Legal standards	1	CO5
7.4	Noise control techniques	1	CO6
	TOTAL	36	

Course Designers:

1. R.K.C. Jeykumar rkcjey@tce.edu
2. K. Keerthy kkciv@tce.edu

18CEPK0	BASICS OF REMOTE SENSING				
	Category	L	T	P	Credit
	PE	3	0	0	3

Preamble

The objective of this course is to provide knowledge on remote sensing of objects on the earth surface using EMR waves with its object response spectral characteristics. This course also highlight the types of platforms like satellites used for remote sensing with image processing techniques and multi level data integration through GPS for real world applications.

Prerequisite

Fundamental of Physics, Mathematics, Geography, Geology and Surveying

Course Outcomes

On the successful completion of the course students will be able to

CO Number	Course Outcome Statement	Weightage*** in %
CO1	Understand the fundamentals of radiation & EMR and its characteristics.	15
CO2	Understand various types of platforms and sensors used for remote sensing.	15
CO3	Understand the process of image processing and interpretation techniques.	15
CO4	Apply knowledge of satellites on various Civil Engineering applications	20
CO5	Illustrate multi level data integration methods for mapping	15
CO6	Apply knowledge of GPS for real time scenarios	20

*** Weightage depends on Bloom's Level, number of contact hours.

CO Mapping with CDIO Curriculum Framework

CO #	TCE Proficiency Scale	Learning Domain Level			CDIO Curricular Components (X.Y.Z)
		Cognitive	Affective	Psychomotor	
CO1	TPS2	Understand	Respond	Guided Response	1.1.2
CO2	TPS2	Understand	Respond	Guided Response	1.1.2
CO3	TPS2	Understand	Respond	Guided Response	1.1.2
CO4	TPS3	Apply	Value	Mechanism	1.1.2,2.1.4,2.2.2
CO5	TPS3	Apply	Value	Mechanism	1.1.2,2.1.4,2.2.2
CO6	TPS3	Apply	Value	Mechanism	1.2.7,2.1.4,2.2.2

Mapping with Programme Outcomes and Programme Specific Outcomes

CO's	PO1	PO2	PO3	PO4	PO5	PO6	PO7	PO8	PO9	PO10	PO11	PO12	PSO1	PSO2
CO1	M	L	-	-	-	-	-	-	-	-	-	-	-	-

CO2	M	L	-	-	M	-	-	-	-	-	-	-	-	-
CO3	M	L	-	-	M	L	-	-	L	-	-	L	L	-
CO4	S	M	L	-	L	-	-	-	M	L	-	L	L	L
CO5	S	M	L	-	M	L	L	-	S	L	-	M	L	L
CO6	S	M	L	-	L	-	L	L	L	-	L	M	L	L

S- Strong; M-Medium; L-Low

Assessment Pattern: Cognitive Domain

Cognitive Levels	Continuous Assessment Tests			Assignment			Terminal Examination
	1	2	3	1	2	3	
Remember	50	20	20	-	-	-	20
Understand	50	40	40	100	-	-	40
Apply	0	40	40		100	100	40
Analyse	0	0	0				
Evaluate	0	0	0				
Create	0	0	0				

Assessment Pattern: Psychomotor

Psychomotor Skill	Miniproject/Assignment/Practical Component
Perception	
Set	
Guided Response	50
Mechanism	50
Complex Overt Responses	
Adaptation	
Origination	

Sample Questions for Course Outcome Assessment**

** (2 to 3 at the cognitive level of course outcome)

Course Outcome1(CO1):

1. Define Remote Sensing
2. Recall Plank's law and black body radiation.
3. Describe Spectral Reflectance

Course Outcome2(CO2):

1. Recall various remote sensing platforms used to obtain image of earth
2. Describe various types of sensors.
3. Describe the importance of sensors resolutions in data interpretation.

Course Outcome3(CO3):

1. Explain vector and raster data
2. Discuss the process of interpretation of images
3. Discuss the radiation principles and its application in remote sensing data capturing.

Course Outcome 4 (CO4):

1. Describe the history of Indian space programmes
2. Illustrate the application of various satellites with its resolution

3. Discuss CARTOSAT and RESOURCESATsatellites sensor characteristics.

Course Outcome 5 (CO5):

1. Discuss the need for multi seasonal data for LULC analysis
2. Describe the application of multi stage and multi platform imaging
3. Describe DEM/DTM models.

Course Outcome6(CO6):

1. Define GIS and GPS.
2. List the important types of GPS.
3. Describe various segments of GPS and its importance.

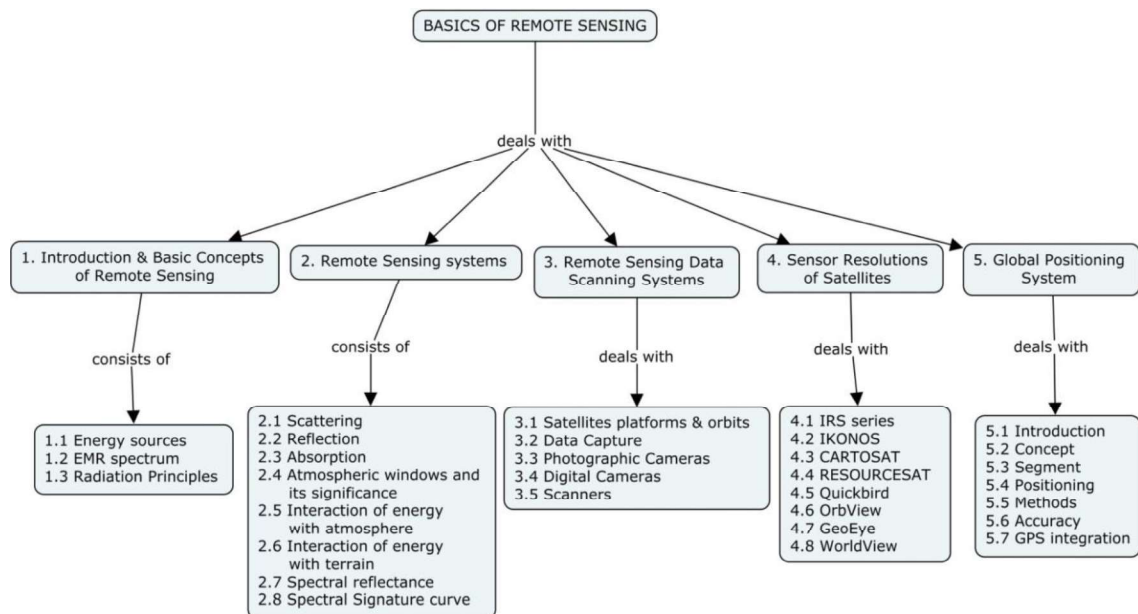
Concept Map**Syllabus**

Introduction and Basic Concepts of Remote Sensing–Sources - EMR spectrum - Radiation Principles **Remote Sensing systems**- Scattering – Reflection – Absorption - Atmospheric windows and its significance – Interaction of energy with atmosphere – Interaction of energy with terrain. Spectral Reflectance – Spectral Signature curve. **Remote Sensing Data Scanning Systems**-Satellites platforms and orbits -Data Capture. Photographic Cameras - Digital Cameras –Scanners **Sensor Resolutions of Satellites**– IRS series – IKONOS, CARTOSAT – RESOURCESAT, Quickbird, OrbView, GeoEye, WorldView.**Global Positioning System**– Introduction– Concept - Segment - Positioning – Methods – Accuracy- GPS integration.

Learning Resources

1. Lillesand, Thomas, Ralph W. Kiefer, and Jonathan Chipman. Remote sensing and image interpretation, John Wiley & Sons, 2014.
2. Hofmann-Wellenhof, B., Lichtenegger, H., & Collins, J. Global positioning system: theory and practice, Springer Science & Business Media, 2012.
3. Jensen, John R. Remote sensing of the environment: An earth resource perspective 2nd edition, Pearson Education India, 2009.
4. Campbell, James B., and Randolph H. Wynne. Introduction to remote sensing. Guilford Press, 2011.

5. El-Rabbany, A. Introduction to GPS: the global positioning system, Artech House, 2002.
6. Gopi, S. Global positioning System: Principles and applications, Tata McGraw-Hill Education, 2005.
7. NPTEL: <https://nptel.ac.in/courses/105103193/>
8. IIRS.

Course Contents and Lecture Schedule			
Module No.	Topic	No. of Hours	Course Outcome
1.	Introduction and basic concepts of Remote Sensing		
1.1	Definitions and Energy sources	1	CO1
1.2	EMR spectrum –wavelength and frequency, regions and its properties	1	CO1
2.	Radiation laws – Plank's, Stefan, Kirchhoff's law and Boltzman law, radiant and kinetic temperature	1	CO1
2.1	Black body radiation	1	CO1
2.2	Remote Sensing systems		
2.3	Scattering – Raleigh, Mie and Non-selective scattering	1	CO1
2.4	Reflection and absorption – types of reflecting surfaces and variations in absorption level by various objects and its controlling factors	1	CO1
2.5	Atmospheric windows and its significance	1	CO1
3.	Interaction of energy with atmosphere - Scattering, absorption, transmission, atmospheric windows	1	CO1
3.1	Interaction of energy with terrain – water, ice, vegetation, soils, minerals and rocks.	1	CO1
3.2	Spectral reflectance and concept of signature	1	CO3
	Spectral signature and curve	1	CO3
3.3	Data Processing	1	CO3
4.	Remote Sensing Data Scanning Systems		
4.1	Platforms - Ground, Airborne and Space borne	1	CO2
4.2	Orbital Characteristics – Coverage, Passes, Pointing Accuracy, Geostationary, sun synchronous, shuttle orbit. Semisynchronous orbit (Molniya orbit) and Quasi - zenith satellite orbit	1	CO2
4.3	Whiskbroom scanners, Pushbroom scanners, Side looking scanners, Multi and Hyperspectral scanners.	1	CO2
4.4	Types and Characteristics of Sensors - Imaging and non - imaging sensors, Active and passive sensors	1	CO2
5.	Sensor Resolutions of Satellites		
5.1	Spectral, Spatial, Radiometric & Temporal resolutions	2	CO2
5.2	IRS series – IRS – 1A and IRS – 1B sensors resolutions	1	CO2
	IRS series – IRS – 1C and IRS – 1D sensors resolutions	1	CO2
5.3	OCEANSAT – CARTOSAT – RESOURCESAT sensors resolutions	1	CO3
5.4	Sensors resolutions of IKONOS, Quickbird, OrbView, GeoEye, WorldView	1	CO3
5.5	Other important earth and space imaging satellite sensors resolutions	1	CO3
	Global Positioning System		

5.6	Introduction to GPS, Reference Systems and Coordinate systems: Geodetic coordinate systems, Datum transformations, Height systems, Time systems	2	CO6
5.7	Satellite Navigations constellations and Geopositioning	2	CO6
6.	Global Positioning Systems		
6.1	Basic Concepts - NAVSTAR, GLONASS, Indian Regional navigational Satellite System (IRNSS)	1	CO6
6.2	Control Segment, Space Segments, User Segment	2	CO6
6.3	GPS Positioning Types-Absolute Positioning, Differential positioning.	2	CO6
6.4	GPS Surveying Methods and Accuracy - Static & Rapid Static, Kinematic-Real Time Kinematic Survey – DGPS-GPS Data Processing and Accuracy	2	CO6
	GPS integration- GPSLRF, GPSINS, GPS pseudolite, cellular integration.	2	CO5

Course Designers:

- | | | |
|----|-----------------|----------------|
| 1. | R.K.C. Jeykumar | rkcjey@tce.edu |
| 2. | K .Keerthy | kkciv@tce.edu |

18CEPL0	ENVIRONMENTAL IMPACT ASSESSMENT				
	Category	L	T	P	Credit
	PE	3	0	0	3

Preamble

Any developmental project will have impacts on the physical, social and biological environment. Some impacts are beneficial and some are adverse. EIA is important because it identifies the likely environmental, economical and social burden of the project at the initial phase of the project and informs the decision-makers about the significant impacts and risks associated with the project to promote sustainable development by ensuring the balance between environment and development.

Prerequisite

NIL

Course Outcomes

On the successful completion of the course students will be able to

CO Number	Course Outcome Statement	Weightage*** in %
CO1	Understand the EIA process and categorize the EIA required for proposed projects	15
CO2	Predict and assess the impact of proposed projects on the Environment	20
CO3	Prepare terms of reference for environmental impact for any developmental projects	10
CO4	Apply mathematical tools to predict the impact on environment	10
CO5	Propose proper mitigation measures to avoid environmental impact	25
CO6	Summarize the EIA report with suitable environmental management plan	20

*** Weightage depends on Bloom's Level, number of contact hours,

CO Mapping with CDIO Curriculum Framework

CO #	TCE Proficiency Scale	Learning Domain Level			CDIO Curricular Components (X.Y.Z)
		Cognitive	Affective	Psychomotor	
CO1	TPS2	Understand	Response	Guided Response	1.1,2.3.1,2.3.2,3.2.1
CO2	TPS3	Apply	Value	Mechanisms	1.1,2.3.1,2.4.4,4.4.5
CO3	TPS3	Apply	Value	Mechanisms	2.3.1,2.4.4,3.2.3,4.4.5
CO4	TPS3	Apply	Value	Mechanisms	1.3.6,2.3.1,2.4.4,3.2.5,4.4.5
CO5	TPS3	Apply	Value	Mechanisms	2.3.1,2.4.4,3.2,4.4.5
CO6	TPS3	Apply	Value	Mechanisms	2.3.1,2.4.4,3.2,4.4.5

Mapping with Programme Outcomes and Programme Specific Outcomes

Cos	PO1	PO2	PO3	PO4	PO5	PO6	PO7	PO8	PO9	PO10	PO11	PO12	PSO1	PSO2
CO	M	L	-	-	-	M	M	L	M	M	L	L	M	L

1														
CO 2	S	M	L	-	-	M	M	L	M	M	L	L	M	L
CO 3	S	M	L	-	-	M	S	S	M	S	M	M	M	L
CO 4	S	M	L	-	-	M	S	S	M	S	M	M	M	L
CO 5	S	M	L	-	-	M	S	S	M	S	M	M	M	L
CO 6	S	M	L	-	-	M	S	S	M	S	M	M	M	L

S- Strong; M-Medium; L-Low

Assessment Pattern: Cognitive Domain

Cognitive Levels	Continuous Assessment Tests			Assignment			Terminal Examination
	1	2	3	1	2	3	
Remember	12	12	12	-	-	-	12
Understand	48	48	48	-	-	-	48
Apply	40	40	40	10	10	10	40
Analyse							
Evaluate							
Create							

Assessment Pattern: Psychomotor

Psychomotor Skill	Mini project/Assignment/Practical Component
Perception	-
Set	-
Guided Response	50
Mechanism	50
Complex Overt Responses	-
Adaptation	-
Origination	-

Sample Questions for Course Outcome Assessment**

** (2 to 3 at the cognitive level of course outcome)

Course Outcome1(CO1):

1. Discuss the role of Public Participation in Environmental Decision Making.
2. EIA is an effective management tool: comment
3. Explain the various methodologies adapted for prediction of impacts for EIA report

Course Outcome2(CO2):

1. Explain the legal framework for getting environment clearance for new projects.
2. Describe the procedure for conducting the public hearing as per EIA notification 2006.
3. Explain the legal framework for handling hazardous waste generated from any industry

Course Outcome3(CO3):

1. Prepare terms of reference for coal based Thermal Power Plant having a capacity of 2x330 MW which is located at Nagapattinam district.

2. In Madurai it is propose to develop a CETP for 20 Electroplating units. Identify the potential impacts of the project and prescribe suitable terms of reference for the project.
3. It is proposed to construct a large hydro-electric power project at the foot hills of Varusanaadu. Prepare terms of reference for the socio-economic impacts.

Course Outcome 4 (CO4):

1. Give an overview of models applied for the assessment of impact on groundwater.
2. List the software available for the assessment of impact on the environment.
3. Expert system is an appropriate tool to assess the environmental impact. Justify the satetement.

Course Outcome 5 (CO5):

1. Pudur is a town located along the OMR road. It is proposed to construct 6000 No. of residential houses in that area. Identify the potential impacts of the project and suggest a management plan to mitigate them.
2. Sabarimalai is a pilgrimage town located in Kerala state. It is proposed to develop a Greenfield airport project for the capacity to handle six new generation large aircraft. Identify the potential impacts of the project and suggest a management plan to mitigate them.
3. Prepare risk assessment report for a stand-alone distillery unit having a capacity of 50 klpd. The raw material is sugarcane based molasses. Identify the potential impacts and prepare mitigation plan for the same.

Course Outcome6(CO6):

1. Describe the essential contents of a typical environmental management plan.
2. Outline the chapters specified by the ministry for the preparation of the EIA report in India.

Concept Map

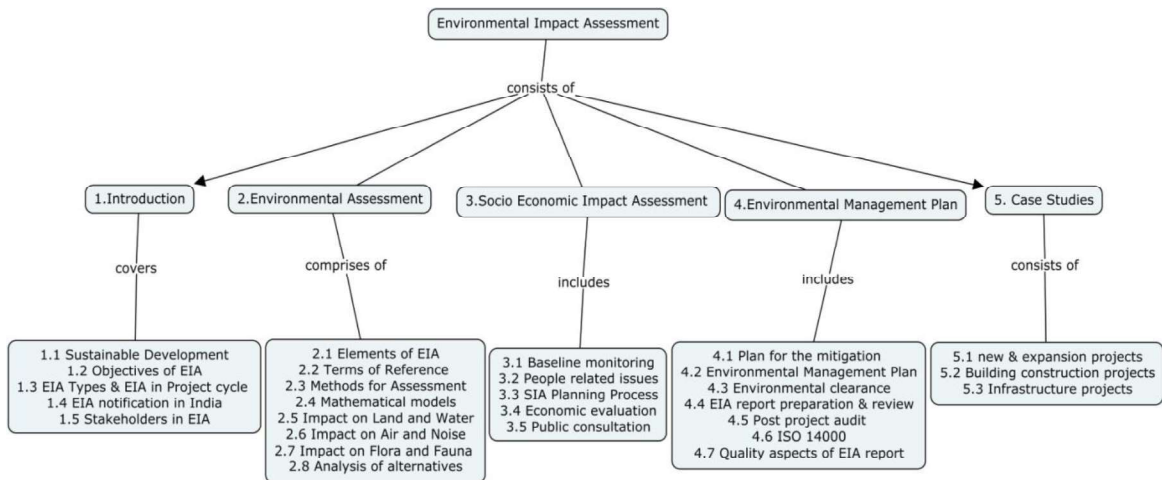

Syllabus

Introduction: Impact of Development on Environment-Sustainable Development-Historical Development and Objectives of EIA-EIA Types & EIA in Project cycle-EIA notification & Legal framework in India. **Environmental Assessment:** Elements of EIA-Terms of Reference & Baseline monitoring-Methods for Assessment – Applicability-Mathematical models for Impact Prediction-Prediction and Assessment of impact on Land, Water, Air, Noise, Flora and Fauna-Analysis of alternatives. **Socio Economic Impact Assessment:** Baseline monitoring of Socio Economic environment-Project affected people related issues-SIA Planning Process-Cost Benefit Analysis - Economic evaluation-Public consultation. **Environmental Management Plan:** Plan for the mitigation of impact on environment-Environmental Management Plan-

Environmental clearance-EIA report preparation & review-Post project audit & Environmental audit-ISO 14000-Quality aspects of EIA report. **Case Studies:** EIA for new & expansion projects, Building construction and area development projects, Infrastructure projects.

Learning Resources

1. Canter, L.W., Environmental Impact Assessment, McGraw Hill, New York, 1996.
2. Lawrence, D.P., Environmental Impact Assessment – Practical Solutions to recurrent problems, Wiley-Interscience, New Jersey, 2003.
3. Petts, J., Handbook of Environmental Impact Assessment, Vol., I and II, Blackwell science, London, 1999.
4. World Bank – Source Book on EIA.

Course Contents and Lecture Schedule

Module No.	Topic	No. of Hours	Course Outcome
1.Introduction			
1.1	Impact of Development on Environment-Sustainable Development	1	CO1
1.2	Historical Development and Objectives of EIA	1	CO1
1.3	EIA Types & EIA in Project cycle	1	CO1
1.4	EIA notification & Legal framework in India	1	CO1
1.5	Stakeholders & their role in EIA	1	CO1
2.Environmental Assessment			
2.1	Elements of EIA	2	CO2
2.2	Terms of Reference & Baseline monitoring	1	CO3
2.3	Methods for Assessment-Applicability	2	CO2
2.4	Mathematical models for Impact Prediction	1	CO4
2.5	Prediction and Assessment of impact on Land and Water	1	CO4
2.6	Prediction and Assessment of impact on Air and Noise	1	CO4
2.7	Prediction and Assessment of impact on Flora and Fauna	1	CO4
2.8	Analysis of alternatives	1	CO2
3.Socio Economic Impact Assessment			
3.1	Baseline monitoring of Socio Economic environment	1	CO3
3.2	Project affected people related issues	1	CO2
3.3	SIA Planning Process	2	CO2
3.4	Cost Benefit Analysis - Economic evaluation	1	CO5
3.5	Public consultation	1	CO3
4.Environmental Management Plan			
4.1	Plan for the mitigation of impact on environment	3	CO5
4.2	Environmental Management Plan	1	CO5
4.3	Environmental clearance	1	CO3
4.4	EIA report preparation & review	1	CO6
4.5	Post project audit & Environmental audit	1	CO5
4.6	ISO 14000	1	CO5
4.7	Quality aspects of EIA report	1	CO6
5. Case Studies			
5.1	EIA for new & expansion projects	2	CO5
5.2	EIA for Building construction and area development projects	2	CO6

5.3	EIA for Infrastructure projects	2	CO6
-----	---------------------------------	---	-----

Course Designers:

1. Dr. V. Ravi Sankar environmentengr@tce.edu
2. Dr. S. Chandran schandran@tce.edu

18CEPM0	DISASTER MITIGATION AND MANAGEMENT
----------------	---

Category	L	T	P	Credit
PE	3	0	0	3

Preamble

This course deals with the various disasters and their effects against built structures, and Hazard Assessment procedure in India. This course also deals with the methods of mitigating various hazards such that their risk and impact on communities is reduced.

Prerequisite

NIL

Course**Outcomes**

On the successful completion of the course students will be able to

CO Number	Course Outcome Statement	Weightage*** in %
CO1	Understand the various types of manmade and natural hazards and disaster	10
CO2	apply the disaster resistant principle to the deficient buildings against natural disaster	30
CO3	apply the risk reduction technique involved in manmade disaster	30
CO4	Apply the vulnerability reduction technique adopted by NDRF, State and local bodies	10
CO5	Apply the hazard assessment procedure to the existing buildings	10
CO6	Apply the alternative communication technique during the disaster	10

*** Weightage depends on Bloom's Level, number of contact hours,

CO Mapping with CDIO Curriculum Framework

CO #	TCE Proficiency Scale	Learning Domain Level			CDIO Curricular Components (X.Y.Z)
		Cognitive	Affective	Psychomotor	
CO1	TPS2	Understand	Respond	Guided Response	1.2,2.1.1
CO2	TPS3	Apply	Value	Mechanism	1.1.1, 1.2, 1.3, 2.1.3, 2.1.4, 2.1.5, 4.4.1, 4.4.2, 4.4.3
CO3	TPS3	Apply	Value	Mechanism	1.1.1, 1.2, 1.3, 2.1.3, 2.1.4, 2.1.5, 4.4.1, 4.4.2, 4.4.3
CO4	TPS3	Apply	Value	Mechanism	1.1.1, 1.2, 1.3, 2.1.3, 2.1.4, 2.1.5, 4.4.1, 4.4.2, 4.4.3
CO5	TPS3	Apply	Value	Mechanism	1.1.1, 1.2, 1.3, 2.1.3, 2.1.4, 2.1.5, 4.4.1, 4.4.2, 4.4.3
CO6	TPS3	Apply	Value	Mechanism	1.1.1, 1.2, 1.3, 2.1.3, 2.1.4, 2.1.5, 4.4.1, 4.4.2, 4.4.3

Mapping with Programme Outcomes and Programme Specific Outcomes

Cos	PO1	PO2	PO3	PO4	PO5	PO6	PO7	PO8	PO9	PO10	PO11	PO12	PSO1	PSO2
CO1	M	L	----	----	----	M	S	M	M	----	M	M	L	M

CO2	S	M	L	----	----	S	S	S	S	----	S	S	M	S
CO3	S	M	L	----	----	S	----	S	S	----	S	S	M	S
CO4	S	M	L	----	----	S	S	S	S	----	S	S	M	S
CO5	S	M	L	----	----	S	S	S	S	----	S	S	M	S
CO6	S	M	L	----	----	S	S	S	S	----	S	S	M	S

S- Strong; M-Medium; L-Low

Assessment Pattern: Cognitive Domain

Cognitive Levels	Continuous Assessment Tests			Assignment			Terminal Examination
	1	2	3	1	2	3	
Remember	10	10	10	-	-	-	10
Understand	10	10	10	-	-	-	10
Apply	80	80	80	100	100	100	80
Analyse				-	-	-	
Evaluate				-	-	-	
Create				-	-	-	

Assessment Pattern: Psychomotor

Psychomotor Skill	Miniproject /Assignment/Practical Component
Perception	-
Set	-
Guided Response	-
Mechanism	Assignment
Complex Overt Responses	-
Adaptation	-
Origination	-

Sample Questions for Course Outcome Assessment**

** (2 to 3 at the cognitive level of course outcome)

Course Level Learning Objectives

Course Outcome (CO1)

1. What is Richter Magnitude?
2. What is Peak ground Acceleration?
3. What is meant by hazard mitigation?

Course Outcome (CO2)

1. List the different types of droughts and highlight its various causes.
2. Define community Contingency Plan
3. How does the site soil affect the EQ response of structures?

Course Outcome (CO3)

1. Explain the plan, Mass and Geometric irregularities in the RC buildings. How these irregularities adversely affect the performance of the RC buildings during Earthquake
2. Discuss the various types of natural disasters and highlight the specific efforts to mitigate disasters in India

Course Outcome (CO4)

1. Describe various types of hazards and impacts associated with earthquakes and highlight the lessons learnt

- Briefly explain the components of follow-up activities in psychological rehabilitation of disaster affected people.

Course Outcome (CO5)

- If you were the relief commissioner of the state of Assam which is affected by floods every year list out five departments that you need to contact.
- Identify four different task forces and list out two responsibilities of each of the task forces
- Do you think disaster risk can be reduced through community participation? Discuss

Course Outcome (CO6)

- Which areas are more prone to heat and cold waves in India? Discuss the preventive and preparedness measures that are mostly adopted for protection from heat and cold waves
- Explain the role of central Government in responding to disasters
- Describe suitable mitigation and preparedness measures that the community should take in advance to guard a EQ disaster occurring again.

Concept Map

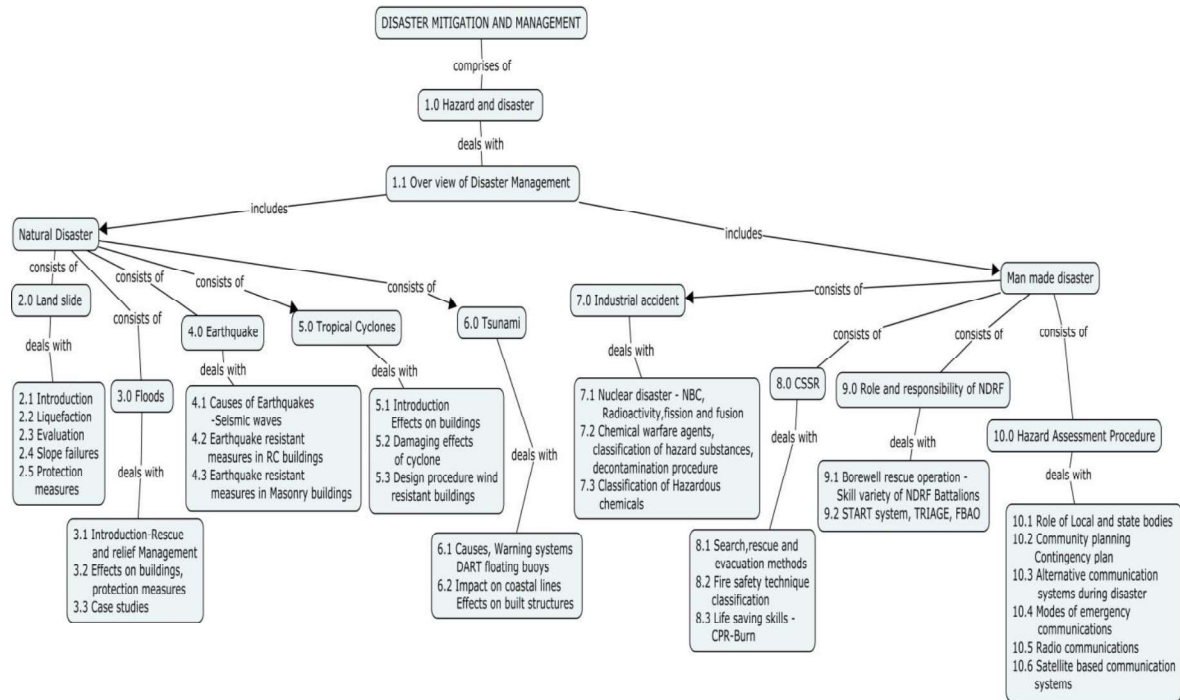

Syllabus

Hazard and disaster -Overview –Types of disasters-Phases of disaster Management - Classification of Hazards - Manmade and Natural disaster **Natural disaster- Earthquake** - Causes -Classification of Earthquakes – Magnitude and intensity - Potential deficiencies of RC and Masonry buildings -EQ resistant measures - **Landslides** -Causes – slopes failure - Preparation of zoning map -Liquefaction potential evaluation -Protection measures **Floods** – Flood zone map - Effects on buildings – protection measures from damage to buildings – Mitigation Strategies **Tropical cyclones** – stages of cyclone warning systems in India - Effects on buildings – protection measures from damage to buildings **Tsunami** - Warning systems DART floating bouys -Tsunami impact on coastal lines -Effects of Tsunami on built structures – Mitigation Management**Manmade disaster - Nuclear disaster** – NBC, Radioactivity, Alpha ,Beta , Gamma decay, fission and fusion Chemical warfare agents, universal classification of

hazard substances and explosives, decontamination procedure - BW agents -Emergency Medical responder, Vital signs (RPSPBP) Classification of Hazardous chemicals **chemical and industrial accidents** – case histories Mitigation strategies **CSSR -Collapsed Structure & Rescue operations** - Search and rescue and evacuation methods - Life saving skills - Body mechanics – CPR **Fire** safety technique classification -Extinguishers- Burn and its classification **Borewell rescue operation****Role and responsibility of NDRF** - Skill variety of NDRF Battalions-MFR-FRRM, CBRN disasters - START system, TRIAGE, FBAO (Foreign body airway Obstruction) **Role of local and state bodies** National level, State level, district level -Community contingency plan –Risk Management - Vulnerability mapping.**Hazard Assessment** - Vulnerability Assessment of Buildings procedure - Visual Inspection Detailed In - situ Investigation Planning and Interpretation of Results – Pushover Analysis **Alternative communication systems during disaster**- Modes of emergency communications-Satellite based communication systems -Radio communications

Course Content and Lecture Schedule

Module No.	Topic	No. of Hours	Course Outcome
1	Introduction - Disaster		
1.1	Over view of Disaster Management	1	CO1
2	Land slide		
2.1	Introduction, Causes, types, preparation of hazard zonation map	1	CO2
2.2	Liquefaction	1	CO2
2.3	Evaluation of Liquefaction potential	1	CO2
2.4	Slope failures	1	CO2
2.5	Protection measures	2	CO2
3	Floods		
3.1	Introduction- Causes -Rescue and relief Management	1	CO2
3.2	Effects on buildings, protection measures from damage to buildings	1	CO2
3.3	Case studies	1	CO2
4	Earthquake Disaster		
4.1	Causes of Earthquakes, Earthquake Size Seismic waves	2	CO2
4.2	Earthquake resistant measures in RC buildings	1	CO2
4.3	Earthquake resistant measures in Masonry buildings	1	CO2
5	Tropical cyclones		
5.1	Introduction, Effects on buildings, Warning systems in India	1	CO2
5.2	Damaging effects of cyclone	1	CO2
5.3	Design procedure for wind resistant buildings	1	CO2
6	Tsunami		
6.1	Tsunami causes, Warning systems DART floating buoys	1	CO2
6.2	Tsunami impact on coastal lines Effects of Tsunami on built structures	1	CO2
7	Man made Disaster - Industrial accident case study	1	
7.1	Nuclear disaster - NBC, Radioactivity, Alpha ,Beta , Gamma decay, fission and fusion	1	CO3
7.2	Chemical warfare agents, universal classification of hazard	2	CO3

	substances and explosives, decontamination procedure - BW agents -Emergency Medical responder, Vital signs (RPSPBP)		
7.3	Classification of Hazardous chemicals	1	CO3
8	CSSR -Collapsed Structure & Rescue operations		
8.1	Search and rescue and evacuation methods	1	CO3
8.2	Fire safety technique classification Extinguishers	1	CO3
8.3	Life saving skills - Body mechanics - CPR - Burn and its classification	1	CO3
9	Role and responsibility of NDRF	1	
9.1	Borewell rescue operation - Skill variety of NDRF Battalions-MFR- FRRM, CBRN disasters	1	CO4
9.2	START system, TRIAGE, FBAO (Foreign body airway Obstruction)	1	CO4
10	Hazard Assessment Procedure		
10.1	Role of Local and state bodies, RVS Method Screening	1	CO5
10.2	Community planning Community Contingency plan	1	CO5
10.3	Alternative communication systems during disaster	1	
10.4	Modes of emergency communications	1	CO6
10.5	Radio communications	1	CO6
10.6	Satellite based communication systems	1	CO6
	TOTAL	36	

Reference Books:

1. David A. McEntire (2014) Disaster Response and Recovery: Strategies and Tactics for Resilience, Wiley Publishers
2. [R. B. Singh](#) (2006) Natural Hazards and Disaster Management: Vulnerability and Mitigation , Rawat Publications
3. [Pradyumna P. Karan](#) (2010)The Indian Ocean Tsunami: The Global Response to a Natural Disaster,[University Press of Kentucky](#)
4. Matthew R. Stein (2011)When Disaster Strikes: A Comprehensive Guide for Emergency Prepping and Crisis Survival. Chelsea Green Publishing
5. Dowrick. D.J (1987), "Earthquake resistant design for Engineers and Architects", John Wiley & Sons, Second Edition.
6. G.K. Ghosh(1993) "Disaster Management" A.P.H. Publishing Corporation, New Delhi
7. R.B. Singh (1992) "Disaster Management" Rawat Publications, New Delhi
8. Ayaz Ahmad(1990) Disaster Management: Through the New Millennium By Anmol Publications, New Delhi
9. Goel, S. L.(1991) "Encyclopaedia of Disaster Management" Deep & Deep Publications Pvt Ltd, New Delhi

IS Codes:

1. IS: 4326-1984, "Indian Std Code of practice for Earthquake Resistant Design and Construction of Buildings".
2. IS: 1893 (Part I)-2002 "Code of practice for Earthquake Resistant Design of Structures

Course Designers:

1. Dr.R.Ponnudurai rpdciv@tce.edu
2. R.Indrajith Krishnan jith@tce.edu

18CEPN0	GROUND WATER MANAGEMENT	Category	L	T	P	Credit
		PE	3	0	0	3

Preamble

The objective of this course is to introduce the principles, methods and practices of well hydraulics and concept of ground water management. It also emphasise the need for protecting ground water resources from contamination and Planning of groundwater development under various conditions and constraints.

Prerequisite

Nil

Course Outcomes

On the successful completion of the course students will be able to

CO Number	Course Outcome Statement	Weightage*** in %
CO1	Explain the origin and occurrence of ground water	10
CO2	Plan and develop ground water resources	20
CO3	Understand the properties and types of aquifers	20
CO4	Estimate the yield from aquifers through pumping test	10
CO5	Apply the artificial Recharge techniques	25
CO6	Formulate Strategies to control the ground water pollution	15

*** Weightage depends on Bloom's Level, number of contact hours,

CO Mapping with CDIO Curriculum Framework

CO #	TCE Proficiency Scale	Learning Domain Level			CDIO Curricular Components (X.Y.Z)
		Cognitive	Affective	Psychomotor	
CO1	TPS2	Understand	Respond	Guided Response	1.1,2.3.1,2.3.2
CO2	TPS2	Apply	Respond	Guided Response	1.1,2.3.1,2.3.2
CO3	TPS3	Understand	Value	Mechanism	1.1,2.3.1,2.3.2,4.1.1,4.1.2,4.1.6
CO4	TPS3	Apply	Value	Mechanism	1.1,2.3.1,2.3.2,4.1.1,4.1.2,4.1.6
CO5	TPS3	Apply	Value	Mechanism	1.1,2.3.1,2.3.2,4.1.1,4.1.2,4.1.6
CO6	TPS3	Apply	Value	Mechanism	1.1,2.3.1,2.3.2,4.1.1,4.1.2,4.1.6

Mapping with Programme Outcomes and Programme Specific Outcome

COs	PO1	PO2	PO3	PO4	PO5	PO6	PO7	PO8	PO9	PO10	PO11	PO12	PSO1	PSO2
CO1	M	L	-	-	-	L	S	-	S	-	-	-	L	-
CO2	S	M	L	-	-	L	L	-	M	-	-	-	L	-

CO3	M	L	-	-	-	M	M	M	L	-	-	-	M	-
CO4	S	M	L	-	-	M	L	-	-	-	-	-	M	-
CO5	S	M	L	-	-	M	S	S	M	-	-	-	M	-
CO6	S	M	L	-	-	M	S	S	M	-	-	-	M	-

S- Strong; M-Medium; L-Low

Assessment Pattern: Cognitive Domain

Cognitive Levels	Continuous Assessment Tests			Assignment			Terminal Examination
	1	2	3	1	2	3	
Remember	20	20	20	-	-	-	20
Understand	40	40	40	-	-	-	40
Apply	40	40	40	10	10	10	40
Analyse							
Evaluate							
Create							

Assessment Pattern: Psychomotor

Psychomotor Skill	Mini project/Assignment/Practical Component
Perception	-
Set	-
Guided Response	50
Mechanism	50
Complex Overt Responses	-
Adaptation	-
Origination	-

Sample Questions for Course Outcome

Course Outcome1(CO1):

1. Derive an expression for the steady state discharge of well fully penetrating into a confined aquifer.
2. In a water table aquifer of 50m thickness, a 20cm diameter well is pumped at a uniform rate of $0.05\text{m}^3/\text{s}$. If the steady state drawdown measured in the observation wells located at 10m and 100m distances from the well are 6.5m and 0.25m respectively, determine the hydraulic conductivity of the aquifer.

Course Outcome2 (CO2):

1. Explain the various practices followed in India for the development of ground water resources.
2. A Sample has a hydraulic conductivity of 15m per day what would be its intrinsic permeability. Estimate its hydraulic conductivity at 30°C .

Course Outcome3 (CO3):

1. Discuss the difference between confined aquifer and unconfined aquifer.
2. Explain the general characteristics of Aquiclude and Aquitard.

Course Outcome 4(CO4):

1. List out the advantages of pumping test?
2. Determine the yield from a 30cm diameter well under a draw down of 10m in the well, if the radius of influence and hydraulic conductivity are 150m and 5m per day respectively. The aquifer is unconfined with a thickness of 60m.

Course Outcome 5(CO5):

1. Explain the various methods of Artificial Recharge of Ground water.
2. How do apply Remote sensing and GIS for augmentation of ground water storage.

Course Outcome 6 (CO6):

1. List out the advantages of ground water compared to surface water?
2. How do you apply the various methods to control pollution hazards in ground water?

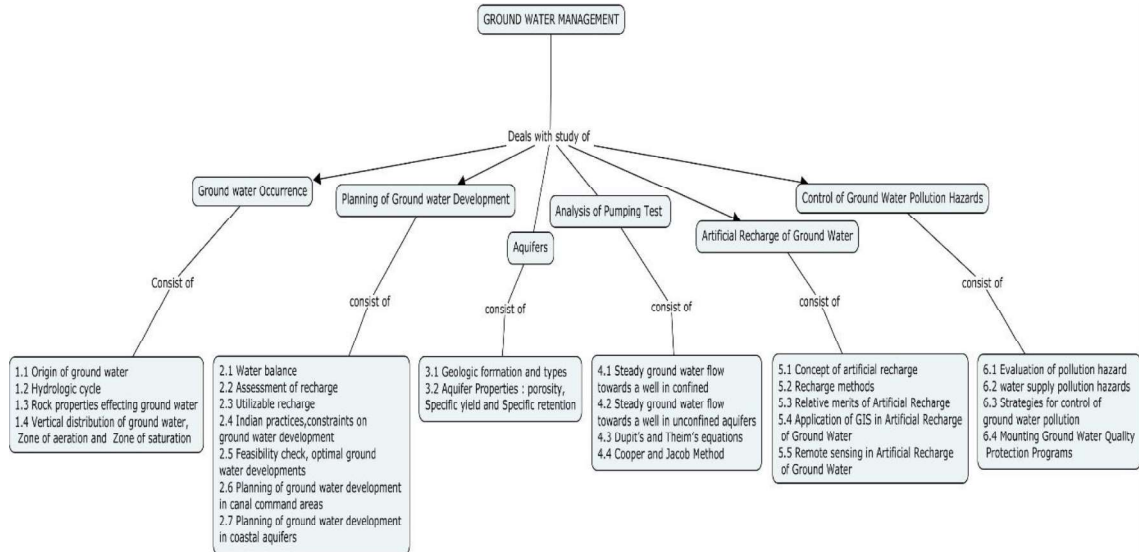
Concept Map**Syllabus**

Ground water Occurrence: Origin of ground water, hydrologic cycle, rock properties effecting ground water, vertical distribution of ground water, zone of aeration and zone of saturation.

Planning of Ground water Development: Water balance, assessment of recharge, utilizable recharge, Indian practices, constraints on ground water development, feasibility check, optimal ground water developments, planning of ground water development in canal command areas, planning of ground water development in coastal aquifers.

Aquifers: Geologic formation, types, porosity, Specific yield and Specific retention.

Analysis of Pumping Test : Steady ground water flow towards a well in confined and unconfined aquifers, Dupit's and Theim's equations, Cooper and Jacob Method.

Artificial Recharge of Ground Water: Concept of artificial recharge, Recharge methods, Relative merits, Application of GIS and Remote sensing in Artificial Recharge of Ground Water.

Control of Ground Water Pollution Hazards: Evaluation of pollution hazard and water supply pollution hazards. Strategies for control of ground water pollution. Mounting Ground Water Quality Protection Programs.

Learning Resources

1. Ground water Hydrology by David Keith Todd, John Wiley & son, New York, Third revised edition(2005)
2. Groundwater by H.M.Raghunath, Wiley Eastern Ltd.(1 December 2007)
3. Groundwater system planning & management- R.Willies & W.W.G.Yeh, Printice Hall (1987).
4. Apply Hydrogeology by C.W.Fetta, CBS Publishers & Distributers (2019).

Course Contents and Lecture Schedule

Module No.	Topic	No. of Hours	Course Outcome
1.0	Ground water Occurrence		
1.1	Origin of ground water	1	CO1
1.2	Hydrologic cycle	1	CO1
1.3	Rock properties effecting ground water	1	CO1
1.4	Vertical distribution of ground water, zone of aeration and zone of saturation	1	CO1
2.0	Planning of Ground water Development		
2.1	Water balance	1	CO 2
2.2	assessment of recharge	1	CO 2
2.3	utilizable recharge	1	CO 2
2.4	Indian practices, constraints on ground water development	1	CO 2
2.5	Feasibility check, optimal ground water developments	1	CO 2
2.6	Planning of ground water development in canal command areas	2	CO 2
2.7	Planning of ground water development in coastal aquifers	1	CO 2
3.0	Aquifers		
3.1	Geologic formation and types	1	CO 3
3.2	Aquifer Properties : porosity, Specific yield and Specific retention	1	CO 3
4.3	Analysis of Pumping Test		
4.1	Steady ground water flow towards a well in confined aquifers	2	CO 3
4.2	Steady ground water flow towards a well in unconfined aquifers	2	CO 3
4.3	Dupit's and Theim's equations	2	CO 4
4.4	Cooper and Jacob Method	2	CO 4
5.0	Artificial Recharge of Ground Water		
5.1	Concept of artificial recharge	1	CO 5
5.2	Recharge methods	1	CO 5
5.3	Relative merits of artificial recharge	1	CO 5
5.4	Application of GIS in artificial recharge of Ground Water	3	CO 5
5.5	Remote sensing in Artificial Recharge of Ground Water.	3	CO 5
6.0	Control of Ground Water Pollution Hazards		
6.1	Evaluation of pollution hazard	2	CO 6
6.2	water supply pollution hazards	1	CO 6
6.3	Strategies for control of ground water pollution	1	CO 6
6.4	Mounting Ground Water Quality Protection Programs	1	CO 6
	TOTAL	36	

Course Designers:

1. Dr. S. Chandran schandran@tce.edu
2. Dr. V. RaviSankar environmentengr@tce.edu

18CEPP0	WASTE MANAGEMENT				
	Category	L	T	P	Credit
	PE	3	0	0	3

Preamble

This course provides an in-depth knowledge of various types of waste, their characteristics, technology and management for the safe disposal of waste generated by a community. This course will also highlight the economic feasibility, legal framework and viability of environmentally sustainable technologies for waste management.

Prerequisite

NIL

Course Outcomes

On the successful completion of the course students will be able to

CO Number	Course Outcome Statement	Weightage*** in %
CO1	Understand the past, present status and environmental challenges in waste management	10
CO2	Compare various waste disposal techniques, practices and designs adopted by community	15
CO3	Apply appropriate processing technologies for different types of waste	20
CO4	Select suitable methods for effective waste management	20
CO5	Suggest suitable economically viable option for safe disposal of waste	15
CO6	Adopt the best practices in waste management for the identified issues	20

*** Weightage depends on Bloom's Level, number of contact hours,

CO Mapping with CDIO Curriculum Framework

CO #	TCE Proficiency Scale	Learning Domain Level			CDIO Curricular Components (X.Y.Z)
		Cognitive	Affective	Psychomotor	
CO1	TPS2	Understand	Respond	Guided Response	1.1,1.2,2.3.1,2.3.2,3.2.1
CO2	TPS2	Understand	Respond	Guided Response	1.1,1.2,2.3.1,2.3.2,3.2.1
CO3	TPS3	Apply	Value	Mechanism	1.1,1.2,2.3.1,2.3.2,2.4.4,2.4.7,3.2.1,4.4.5
CO4	TPS3	Apply	Value	Mechanism	1.1,1.2,2.3.1,2.3.2,2.4.4,2.4.7,3.2.1,4.4.5
CO5	TPS3	Apply	Value	Mechanism	1.1,1.2,2.3.1,2.3.2,2.4.4,2.4.7,3.2.1,4.4.5
CO6	TPS3	Apply	Value	Mechanism	1.1,1.2,2.3.1,2.3.2,2.4.4,2.4.7,3.2.1,4.4.5

Mapping with Programme Outcomes and Programme Specific Outcomes

Cos	PO1	PO2	PO3	PO4	PO5	PO6	PO7	PO8	PO9	PO10	PO11	PO12	PSO1	PSO2
CO1	M	L	-	-	-	L	M	L	-	L	-	-	L	L
CO2	M	L	-	-	-	M	M	-	-	-	-	-	M	L

CO3	S	M	L	-	-	M	M	-	-	M	-	S	L	M
CO4	S	M	L	-	-	L	S	-	-	L	-	-	M	L
CO5	S	M	L	-	-	M	M	-	S	M	-	M	M	M
CO6	S	M	L	-	-	M	M	M	M	M	-	M	M	M

S- Strong; M-Medium; L-Low

Assessment Pattern: Cognitive Domain

Cognitive Levels	Continuous Assessment Tests			Assignment			Terminal Examination
	1	2	3	1	2	3	
Remember	12	12	12	-	-	-	12
Understand	48	48	48	-	-	-	48
Apply	40	40	40	10	10	10	40
Analyse							
Evaluate							
Create							

Assessment Pattern: Psychomotor

Psychomotor Skill	Mini project/Assignment/Practical Component
Perception	-
Set	-
Guided Response	50
Mechanism	50
Complex Overt Responses	-
Adaptation	-
Origination	-

Sample Questions for Course Outcome Assessment**

** (2 to 3 at the cognitive level of course outcome)

Course Outcome1(CO1):

1. Explore the present challenges in the waste management in India.
2. Environmental management system is a step towards effective management-Justify this statement.

Course Outcome2(CO2):

1. List the essential functional elements in Municipal Solid Waste Management.
2. Do you think a sanitary landfill is possible to manage wastes in your locality? List at least three reasons to support your answer.

Course Outcome3(CO3):

1. Compare the environmental effects of composting and bio-gasification.
2. Assess the energy generation potential of Municipal Solid Waste.

Course Outcome 4 (CO4):

1. Discuss the benefits of Environmental Auditing.
2. Explore any three possible ways to reduce the waste at source in daily life

Course Outcome 5 (CO5):

1. Explain the economic aspects of Waste Management?
2. List the characteristics of Hazardous Waste.

Course Outcome6(CO6):

1. Suggest the best disposal option for the hazardous waste generated from your locality.
2. Discuss the various issues faced by municipal authorities in identifying the disposal site.

Concept Map

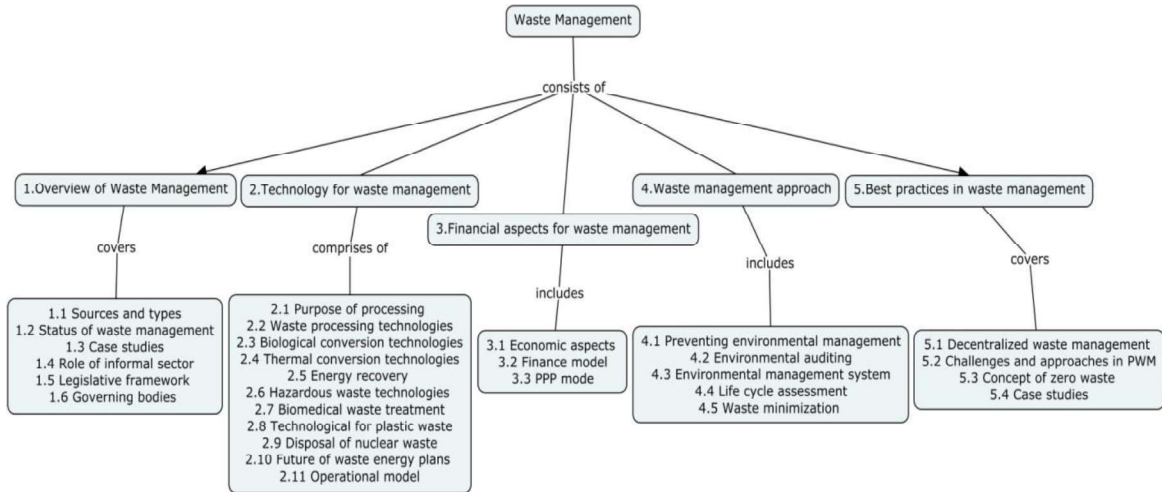

Syllabus

Overview of Waste Management: Sources and types of waste; Status of waste management; Environmental challenges of Waste Management; Role of informal sector Legislative framework; Governing bodies and organizational structure of responsible authorities. **Technology for waste management:** processing technologies; Biological and thermal conversion technologies; Energy recovery from conversion products; Hazardous waste Biomedical waste and plastic waste treatment; Disposal of nuclear waste. **Understanding finance for waste management:** Decentralized waste management concept; Economic aspects of waste management; Finance plan for waste management- PPP model-case studies. **Waste management approach:** Preventing environmental management; Environmental auditing; Environmental management system- ISO14001;Life cycle assessment; Waste minimization and 3R concept. **Best practices in waste management:** Challenges and approaches in plastic waste management; Concept of zero waste management; Case studies.

Learning Resources

1. George Tchobanoglous, Hilary Thiesen and Samuel A Vigil, "Integrated Solid Waste Management: Engineering Principles and Management Issues", McGraw Hill Publishers, New York, 1993.
2. "Manual on Municipal Solid Waste Management", CPHEEO, Ministry of Urban Development, Government of India, New Delhi, 2016.
3. Bhide, A. D. and Sundaresan, B. B. "Solid Waste Management Collection, Processing and Disposal", ISBN 81-7525-282-0, 2001.
4. Paul T Williams, "Waste Treatment and Disposal", John Wiley and Sons, England, 2005.

Course Contents and Lecture Schedule

Module No.	Topic	No. of Hours	Course Outcome
------------	-------	--------------	----------------

1.0 Overview of Waste Management			
1.1	Sources and types of waste	2	CO2
1.2	Status of waste management-an overview.	1	CO2
1.3	Environmental and Social challenges of Waste Management - case studies	1	CO1
1.4	Role of informal sector in Waste Management	1	CO1
1.5	Legislative framework and status of compliance for waste management	1	CO1
1.6	Governing bodies and organizational structure of responsible authorities	1	CO1
2.0 Technology for waste management			
2.1	Purpose of processing and processing technologies – an overview	1	CO2
2.2	Waste processing technologies for municipal solid waste	2	CO3
2.3	Biological conversion technologies	1	CO3
2.4	Thermal conversion technologies	1	CO3
2.5	Energy recovery from conversion products	1	CO3
2.6	Hazardous waste technologies options	1	CO3
2.7	Biomedical waste treatment	1	CO3
2.8	Technological options for plastic waste	1	CO3
2.9	Disposal of nuclear waste	1	CO2
2.10	Future of waste energy plans in developing countries	1	CO5
2.11	Operational model for effective waste management	1	CO4
3.0 Financial aspects for waste management			
3.1	Economic aspects of waste management	2	CO5
3.2	Finance model for waste management	1	CO5
3.3	PPP mode- Case studies	2	CO5
4.0 Waste management approach			
4.1	Preventing environmental management	1	CO4
4.2	Environmental auditing-case studies	2	CO4
4.3	Environmental management system- ISO14001	1	CO4
4.4	Life cycle assessment	1	CO4
4.5	Waste minimization and 3R concept	1	CO4
5.0 Best practices in waste management			
5.1	Decentralized waste management concept	2	CO6
5.2	Challenges and approaches in plastic waste management	1	CO6
5.3	Concept of zero waste – Case studies.	1	CO6
5.4	Case studies in different engineering disciplines	2	CO6
TOTAL		36	

Course Designers:

1. Dr. V. Ravi Sankar environmentngr@tce.edu
2. Dr. S.Chandran schandran@tce.edu

18CEPQ0	GROUND IMPROVEMENT TECHNIQUES				
	Category	L	T	P	Credit
	PE	3	0	0	3

Preamble

This course deals with the different methods adopted for improving the properties of remoulded and in-situ soils by techniques such as in-situ densification, consolidation and dewatering. This course enables the graduates to understand how reinforced earth walls can obviate the problems associated with conventional retaining walls. Also the graduates are exposed to the concepts of grouting, soil stabilization and the use of geotextiles to improve the engineering performance of soils.

Prerequisite

18CE520 - Soil Mechanics; 18CE620 – Foundation Engineering

Course Outcomes

On the successful completion of the course students will be able to

CO Number	Course Outcome Statement	Weightage in %
CO1	Understand the role of ground improvement and select appropriate ground improvement technique for the given subsoil condition.	10
CO2	Suggest appropriate dewatering technique for lowering the ground water table	20
CO3	Recommend suitable techniques for densifying cohesionless soil deposits	15
CO4	Suggest appropriate techniques for improving cohesive soil deposits	15
CO5	Perform simple design of reinforced earth walls and illustrate the role of geo-textile in ground improvement	20
CO6	Explain the concept of grouting and soil stabilization for improving the engineering performance of soils.	20

CO Mapping with CDIO Curriculum Framework

CO #	TCE Proficiency Scale	Learning Domain Level			CDIO Curricular Components (X.Y.Z)
		Cognitive	Affective	Psychomotor	
CO1	TPS2	Understand	Respond	Guided Response	1.1.1,1.1.2,1.2.2,1.1,2.1.3,2.1.5,2.4.2, 2.4.6,3.1.1,3.1.2,4.1.1,4.1.2,4.3.4
CO2	TPS3	Apply	Value	Mechanism	1.1.1,1.1.2,1.2.2,1.1,2.1.3,2.1.5,2.4.2, 2.4.6, 3.1.1,3.1.2,4.1.1,4.1.2,4.3.4
CO3	TPS3	Apply	Value	Mechanism	1.1.1,1.1.2,1.2.2,1.1,2.1.3,2.1.5,2.4.2, 2.4.6, 3.1.1,3.1.2,4.1.1,4.1.2,4.3.4
CO4	TPS3	Apply	Value	Mechanism	1.1.1,1.1.2,1.2.2,1.1,2.1.3,2.1.5,2.4.2, 2.4.6,3.1.1,3.1.2,4.1.1,4.1.2,4.3.4
CO5	TPS3	Apply	Value	Mechanism	1.1.1,1.1.2,1.2.2,1.1,2.1.3,2.1.5,2.4.2, 2.4.6,3.1.1,3.1.2,4.1.1,4.1.2,4.3.4
CO6	TPS2	Understand	Respond	Guided Response	1.1.1,1.1.2,1.2.2,1.1,2.1.3,2.1.5,2.4.2, 2.4.6,3.1.1,3.1.2,4.1.1,4.1.2,4.3.4

Mapping with Programme Outcomes and Programme Specific Outcomes

Cos	PO1	PO2	PO3	PO4	PO5	PO6	PO7	PO8	PO9	PO10	PO11	PO12	PSO1	PSO2
CO 1	M	L	-	-	-	L	L	M	M	M	L	L	L	L
CO 2	S	M	L	-	-	M	M	S	S	S	L	M	M	M
CO 3	S	M	L	-	-	M	M	S	S	S	L	M	M	M
CO 4	S	M	L	-	-	M	M	S	S	S	L	M	M	M
CO 5	S	M	L	-	-	M	M	S	S	S	L	M	M	M
CO 6	M	L	-	-	-	M	M	S	S	S	L	M	L	M

S- Strong; M-Medium; L-Low

Assessment Pattern: Cognitive Domain

Cognitive Levels	Continuous Assessment Tests			Assignment			Terminal Examination
	1	2	3	1	2	3	
Remember	10	10	10	-	-	-	10
Understand	40	30	30	50	40	40	30
Apply	50	60	60	50	60	60	60
Analyse							
Evaluate							
Create							

Assessment Pattern: Psychomotor

Psychomotor Skill	Miniproject/Assignment/Practical Component
Perception	-
Set	-
Guided Response	70
Mechanism	30
Complex Overt Responses	-
Adaptation	-
Origination	-

Sample Questions for Course Outcome Assessment****Course Outcome 1 (CO1):**

1. Explain in detail the role of ground improvement in foundation engineering.
2. Mention the problems associated with challenging soils.
3. Explain in brief the various methods of ground improvement.

Course Outcome 2 (CO2):

1. Mention the purpose of dewatering.
2. Explain in detail with a neat sketch the method of dewatering using sumps and ditches stating its advantages and disadvantages.
3. Explain in brief the principle, equipment used, installation and operation and precaution adopted in electro-osmotic dewatering.

Course Outcome 3 (CO3):

1. Compare and contrast the various methods of in-situ densification techniques
2. Differentiate lime pile from sand compaction pile.

3. Explain in detail the dynamic compaction methods of cohesion less soil deposit.

Course Outcome 4 (CO4):

1. Explain the concept of pre-loading. How do vertical drains improve the functioning of pre-loading technique?
2. Explain the installation process of stone columns.
3. Explain the installation process of lime piles.

Course Outcome 5 (CO5):

1. Name any four applications of soil reinforcement for ground improvement.
2. Draw a reinforced earth wall and explain its components.
3. Geosynthetics can be used as soil reinforcement – Justify in detail with supporting sketches.

Course Outcome 6 (CO6):

1. Describe in detail about the various methods of grouting with neat sketches.
2. Enumerate with a neat sketch the grouting plant and equipment necessary and the procedure for carrying out grouting operations.
3. Explain in detail how an expansive soil is stabilized.

Concept Map

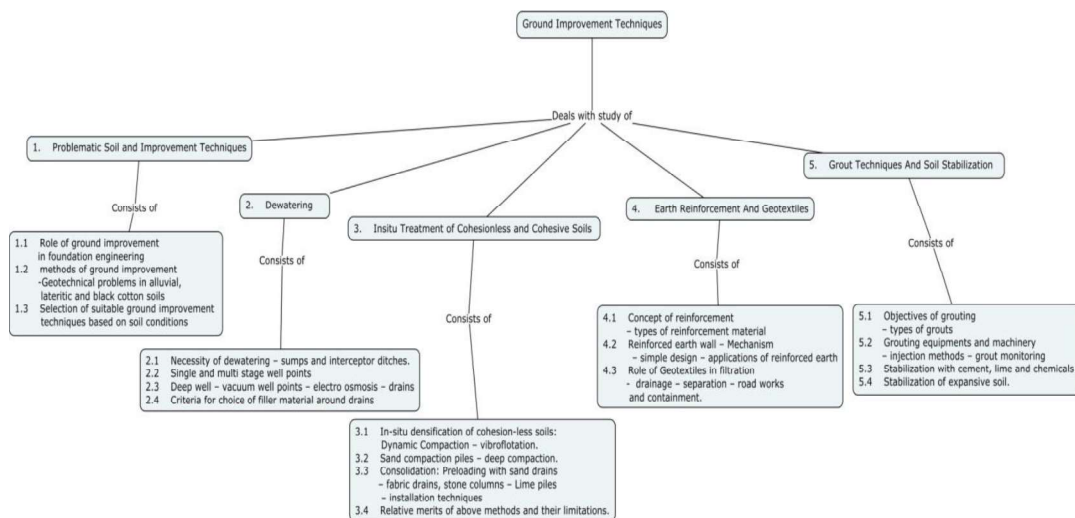

Syllabus

Problematic Soil and Improvement Techniques: Role of ground improvement in foundation engineering – methods of ground improvement – Geotechnical problems in alluvial, lateritic and black cotton soils – Selection of suitable ground improvement techniques based on soil conditions. **Dewatering:** Necessity of dewatering – sumps and interceptor ditches – single and multi-stage well points – deep well - vacuum well points – electro osmosis drains – criteria for choice of filler material around drains. **In-situ Treatment of Cohesionless Soils:** In-situ densification of cohesion-less soils: Dynamic Compaction - vibroflotation, sand compaction piles - deep compaction. **In-situ Treatment of Cohesive Soils:** Consolidation - Preloading with sand drains - fabric drains, stone columns - Lime piles - installation techniques – relative merits of above methods and their limitations **Earth Reinforcement And Geotextiles:** Concept of reinforcement – types of reinforcement material – Reinforced earth wall – Mechanism – simple design – applications of reinforced earth - Role of Geotextiles in filtration - drainage - separation - road works and containment **Grouting Techniques and Soil Stabilization:** Objectives of

grouting - types of grouts – grouting equipments and machinery – injection methods – grout monitoring – stabilization with cement, lime and chemicals – stabilization of expansive soil.

Learning Resources

1. Purushothama Raj. P, "Ground Improvement Techniques", Laxmi Publications (P) Ltd, New delhi, 2015.
2. Mittal.S, "An Introduction to Ground Improvement Engineering", Medtech Publisher, 2013.
3. NPTEL Material <https://nptel.ac.in/courses/105108075/>

IS Code of practice :

- IS9759 : 1981 "Guidelines for Dewatering During Construction", Bureau of Indian Standards, New Delhi, Reaffirmed 1999.
- IS15284 (Part 1) : 2003 "Design and Construction for Ground Improvement – Guidelines" (Stone Column), Bureau of Indian Standards, New Delhi, 2003.

Course Contents and Lecture Schedule

Module No.	Topics	No. of Lectures	Course Outcome
1.	Problematic Soil and Improvement Techniques		
1.1	Role of ground improvement in foundation engineering	1	CO1
1.2	methods of ground improvement – Geotechnical problems in alluvial, lateritic and black cotton soils	2	
1.3	Selection of suitable ground improvement techniques based on soil conditions	2	
2.	Dewatering		
2.1	Necessity of dewatering – sumps and interceptor ditches.	2	CO2
2.2	Single and multi stage well points	2	
2.3	Deep well – vacuum well points – electro osmosis drains	2	
2.4	Criteria for choice of filler material around drains	2	
3.	Insitu Treatment of Cohesionless Soils		
3.1	In-situ densification of cohesion-less soils: Dynamic Compaction – vibroflotation.	2	CO3
3.2	Sand compaction piles – deep compaction.	2	
4.	Insitu Treatment of Cohesive Soils		
4.1	Consolidation: Preloading with sand drains – fabric drains, stone columns – Lime piles – installation techniques	2	CO4
4.2	Relative merits of above methods and their limitations.	2	
5.	Earth Reinforcement And Geotextiles		
5.1	Concept of reinforcement – types of reinforcement material	2	CO5
5.2	Reinforced earth wall – Mechanism – simple design –	2	
5.3	Applications of reinforced earth	1	
5.4	Role of Geotextiles in filtration - drainage– separation – road works and containment.	2	
6.	Grout Techniques And Soil Stabilization		
6.1	Objectives of grouting – types of grouts	2	CO6
6.2	Grouting Equipments and machinery – injection methods	2	

6.3	Grout monitoring	1	
6.3	Stabilization with cement, lime and chemicals	2	
6.4	Stabilization of expansive soil.	1	
	Total Hours	36	

Course Designers:

1. Dr. R. Sanjay Kumar

sanjaykumar@tce.edu

18CEPR0	TRAFFIC ENGINEERING AND SAFETY				
	Category	L	T	P	Credit
	PE	3	0	0	3

Preamble

Students will acquire comprehensive knowledge of traffic surveys and studies such as volume count, Speed and delay, origin and destination, Parking, pedestrian and accident surveys. They will achieve knowledge on design of intersections. Students will become familiar with various traffic control and traffic management measures.

Prerequisite

Fundamentals of Highway Engineering

Course Outcomes

On the successful completion of the course students will be able to

CO Number	Course Outcome Statement	Weightage*** in %
CO1	Explain road user and vehicular characteristics	15
CO2	Apply the knowledge of traffic surveys in traffic management	20
CO3	Design geometrics of intersections	15
CO4	Apply the methods of traffic control aids in road network	20
CO5	Explain the rules and regulations of road safety	15
CO6	Adapt a suitable road safety management technique for congested traffic pattern	15

*** Weightage depends on Bloom's Level, number of contact hours,

CO Mapping with CDIO Curriculum Framework

CO #	TCE Proficiency Scale	Learning Domain Level			CDIO Curricular Components (X.Y.Z)
		Cognitive	Affective	Psychomotor	
CO1	TPS3	Apply	Value	Mechanism	1.1.1,1.2,3.2.1,3.2.2,3.3.1,4.1,4.4,4.5,
CO2	TPS3	Apply	Value	Mechanism	1.1,1.2,2.1.1,2.1.2,2.1.3,2.1.4,2.1.5,2.2,2.3.1,2.3.2,2.4.3,2.4.6,2.4.7, 3.3.1,4.4,4.5
CO3	TPS3	Apply	Value	Mechanism	1.1.1,2.1,2.3,2.4.6,3.3.1,4.1,4.3.1,4.4,4.6.1
CO4	TPS3	Apply	Value	Mechanism	1.1.1,1.1.2,2.1,2.2,2.5,3.3.1,4.1,4.3,4.4,4.5
CO5	TPS2	Understand	Respond	Guided Response	1.2,2.1,2.3,3.3.1,4.5,4.6
CO6	TPS3	Apply	Value	Mechanism	1.1.2,1.2,2.2,2.3,3.1,4.1,4.2,4.3,4.4,4.5,4.6

Mapping with Programme Outcomes and Programme Specific Outcomes

Cos	PO1	PO2	PO3	PO4	PO5	PO6	PO7	PO8	PO9	PO10	PO11	PO12	PSO1	PSO2
CO 1	S	M	L	-	-	-	-	-	-	-	S	L	M	L

CO 2	S	M	L	-	-	M	-	M	L	S	S	M	M	M
CO 3	S	M	L	-	-	S	M	S	M	M	S	M	M	M
CO 4	S	M	L	-	-	S	S	S	S	M	S	M	M	S
CO 5	M	L	-	-	-	L	L	S	S	S	S	S	L	M
CO 6	S	M	L	-	-	S	S	S	S	M	S	S	M	S

S- Strong; M-Medium; L-Low

Assessment Pattern: Cognitive Domain

Bloom's Category	Continuous Assessment Tests			Assignment			Terminal Examination
	1	2	3	1	2	3	
Remember	20	20	20	-	-	-	20
Understand	20	20	40	-	-	-	20
Apply	60	60	40	10	10	10	60
Analyse	0	0	0	-	-	-	0
Evaluate	0	0	0	-	-	-	0
Create	0	0	0	-	-	-	0

Assessment Pattern: Psychomotor

Psychomotor Skill	Miniproject /Assignment/Practical Component
Perception	-
Set	-
Guided Response	20
Mechanism	80
Complex Overt Responses	-
Adaptation	-
Origination	-

Sample Questions for Course Outcome Assessment

Course Outcome1(CO1):

1. State the functions of traffic engineering.
2. Explain in detail the various road characteristics which affect the traffic performances.
3. A truck weighing 10 tons is required to accelerate at a rate of 1m/sec^2 from an initial speed of 10kph to 20kph. The upward gradient is 1 percent and the road has a premix carpet in good condition, the coefficient of rolling resistance being 0.016. the frontal area is 5.37m^2 and the coefficient of air resistance is 0.48kg/m^3 . The car tyres have radius of 0.34m. The rear axle gear ratio is 3.67:1 and the first gear ratio is 2.67:1. The transmission efficiency is 0.90. Calculate the horse-power needed and the speed of the engine.

Course Outcome 2(CO2):

1. Summarize the various factors affecting the practical capacity of road.
2. The following data were obtained from the spot speed studies.
Suggest i) Speed limit for regulation ii) Speed to check geometric design elements
iii) Lower speed group causing congestion iv) Dispersion.

Speed range kmph	0-10	10-20	20-30	30-40	40-50	50-60	60-70	70-80	80-90	90-100
------------------	------	-------	-------	-------	-------	-------	-------	-------	-------	--------

No. of vehicles observed	20	45	75	95	290	420	210	155	85	40
--------------------------	----	----	----	----	-----	-----	-----	-----	----	----

3. Apply the concept of collision and condition diagram for the accident spot

Course Outcome3(CO3):

1. Traffic flow in an urban section at the intersection of two highways in the design year is given below. The highways intersect at right angles and have a carriage way width of 16m. Design the rotary intersection using PCU value of car =1, commercial vehicle (com.v) =2.8 and scooter (SC)=0.75.

Approach	Left turning			Straight Ahead			Right Turning		
	Car	Com.V	SC	Car	Com.V	SC	Car	Com.V	SC
N	200	50	100	250	40	160	150	50	80
E	175	60	80	210	60	120	150	60	120
S	245	70	100	120	50	80	160	55	80
W	210	40	120	190	45	100	180	75	100

2. What do you mean by Interchange in Grade separated intersection?
3. Illustrate the concept of Level of service for a road network.

Course Outcome 4 (CO4):

1. Discuss the road markings required to enhance road safety.
2. Assume a city has congested traffic patterns. Illustrate traffic signs for that city.
3. Review about Traffic signal diagram, types and Signal Coordination

Course Outcome 5 (CO5):

1. Prepare a report of government and NGO's role in road safety.
2. Discuss in detail about traffic laws in India.
3. Summarize National road safety policy.

Course Outcome6(CO6):

1. Demonstrate the concept of Transportation System Management for commercial area.
2. Explain about Intelligent transport system (ITS) in detail.
3. When the prohibition of left turning is applicable?

Concept Map

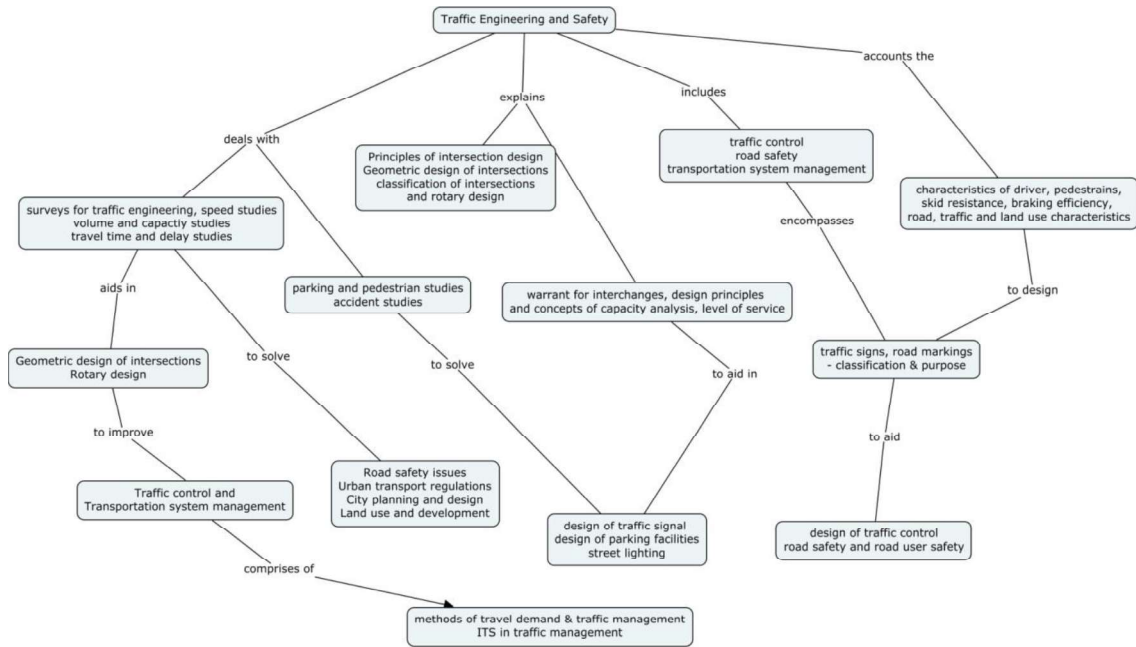

Syllabus

Introduction. Significance and scope, Characteristics of Driver, the pedestrian, the vehicle and road, skid resistance and braking efficiency. Components of traffic engineering – road, traffic and land use characteristics. **Traffic Surveys and Analysis** -volume, capacity speed and delay studies, origin and destination, parking studies, pedestrian and Accident studies. **Geometric Design of intersection-** conflict points at intersections, principles and elements of intersection design, rotary design, Interchanges – Warrant for interchanges, design principles of interchange –level of service. **Traffic Control-** Traffic signs, road markings, design of traffic signal and signal coordination. Traffic Control aids - street furnitures, street lighting **Road safety-** Definition, Objectives, Road safety demographics, Traffic regulations – basic principles, National Road Safety Policy, Motor Vehicle Act – 1988, Intersection safety, driving in night times, long journey, road safety at road works. **Traffic management systems** - methods and techniques for traffic management - role of ITS in traffic management.

Learning Resources

1. Kadiyali L.R, “Traffic Engineering and Transportation Planning” Khanna Publishers, Delhi, 2005.
2. Khanna SK and Justo CEG, “Highway Engineering”, Nem Chand & Bros, Roorkee, 2010.
3. Mike Slinn, Peter Guest and Paul Matthews “Traffic Engineering Design Principles and Practice”, Elsevier, 2006. Online courses
4. <https://nptel.ac.in/courses/105101008/>
5. <https://www.crridom.gov.in/content/traffic-engineering-and-safety>

Course Contents and Lecture Schedule

Module No.	Topic	No. of Hours	Course Outcome
1.0	Introduction		
1.1	Significance and scope, Characteristics of Driver, the pedestrian, the vehicle and road, skid resistance and braking efficiency	3	CO1

1.2	Components of traffic engineering – road, traffic and land use characteristics	3	CO1
2.0	Traffic Surveys and Analysis		
2.1	Surveys for Traffic Engineering, Speed studies	2	CO2
2.2	Volume and capacity Studies	1	CO2
2.3	Travel time and Delay Studies	1	CO2
2.4	Parking and pedestrian Studies	1	CO2
2.5	Accident Studies(concepts and problems)	2	CO2
3.0	Geometric Design of intersection		
3.1	Conflict points at intersections	1	CO3
3.2	Principles and elements of intersection design	1	CO3
3.3	Classification of intersection – concepts of flow in at grade and grade separated intersections	1	CO3
3.4	Rotary design	2	CO3
3.5	Warrant for interchanges, design principles of interchange – capacity analysis level of service (concepts)	2	CO3
4.0	Traffic Control		
4.1	Traffic signs, road markings – significance, classification and purpose	2	CO4
4.2	Design of traffic signal and signal coordination.	2	CO4
4.3	Traffic control aids -Types of street furnitures	1	CO4
4.4	Street lighting – Purpose, importance	2	CO4
5.0	Road safety		
5.1	Definition, Objectives, Road safety demographics	1	CO5
5.2	Traffic regulations – basic principles, National Road Safety Policy, Motor Vehicle Act – 1988	1	CO5
5.3	Intersection safety, driving in night times, long journey, road safety at road works	2	CO5
6.0	Transportation System Management		
6.1	Methods of Travel demand & traffic management	3	CO6
6.2	Role of ITS in traffic management	2	CO6
TOTAL HOURS		36	

Course Designers:

1. Dr. R. Velkennedy rvkciv@tce.edu
2. Ms.T.Karthigaipriya karthigaipriya@tce.edu

18CEPS0	REPAIR AND REHABILITATION OF STRUCTURES				
	Category	L	T	P	Credit
	PE	3	0	0	3

Preamble

To impart knowledge on understanding the properties of concrete, causes of its failure, effects and measures to repair and rehabilitate it.

Prerequisite

Nil

Course Outcomes

On the successful completion of the course students will be able to:

CO Number	Course Outcome Statement	Weightage** in %
CO1	Explain the factors affecting the durability of concrete structures	15
CO2	Identify the causes and effects of distress in concrete structures	15
CO3	Diagnose distress in concrete structures and suggest suitable maintenance and repair strategies	10
CO4	Enumerate the concept of quality assurance in structures, basic mechanisms by which quality assurance schemes are developed and operated with case studies	10
CO5	Suggest suitable materials of repair related to the distress with case studies	25
CO6	Suggest suitable techniques of repair to distress structures with case studies	25

** Weightage depends on Bloom's Level, number of contact hours,

CO Mapping with CDIO Curriculum Framework

CO #	TCE Proficiency Scale	Learning Domain Level			CDIO Curricular Components (X.Y.Z)
		Cognitive	Affective	Psychomotor	
CO1	TPS2	Understand	Respond	Guided Response	1.2,1.3,2.3.1,2.5.4,3.1.1,3.2.6, 4.1.1,4.1.2,4.3.1,4.6.5,4.6.6
CO2	TPS2	Understand	Respond	Guided Response	1.2,1.3, 2.3.1,2.5.4,3.1.1,3.2.6, 4.1.1,4.1.2,4.3.1,4.6.5,4.6.6
CO3	TPS3	Apply	Value	Mechanism	1.2,1.3,2.1.1.2.1.5,2.3.1, 2.3.1,2.3.4,3.2.3,3.2.6,4.1.2, 4.1.3,4.3.1,4.3.2,4.4.1, 4.4.4,4.6.1,4.6.2,4.6.3
CO4	TPS3	Apply	Value	Mechanism	1.2,1.3,2.1.1.2.1.5,2.3.1, 2.3.1,2.3.4, 3.2.3,3.2.6,4.1.2, 4.1.3,4.3.1,4.3.2,4.4.1, 4.4.4,4.4.6,4.6.1,4.6.2,4.6.3
CO5	TPS3	Apply	Value	Mechanism	1.2,1.3,2.1.1.2.1.5,2.3.1, 2.3.1,2.3.4,2.5.4,3.2.3,3.2.6,4.1.2, 4.1.3,4.1.6,4.3.1,4.3.2,4.4.1,

					4.4.4,4.4.6,4.6.1,4.6.2,4.6.3
CO6	TPS3	Apply	Value	Mechanism	1.2,1.3,2.1.1.2.1.5,2.3.1, 2.3.1,2.3.4,2.5.4,3.2.3,3.2.6,4.1.2, 4.1.3,4.1.6,4.3.1,4.3.2,4.4.1, 4.4.4,4.4.6,4.6.1,4.6.2,4.6.3

Mapping with Programme Outcomes and Programme Specific Outcomes

Cos	PO1	PO2	PO3	PO4	PO5	PO6	PO7	PO8	PO9	PO10	PO11	PO12	PSO1	PSO2
CO 1	M	L	-	-	-	-	-	-	-	S	M	L	L	L
CO 2	M	L	-	-	-	M	-	-	-	M	M	L	L	L
CO 3	S	M	L	-	-	-	-	M	M	M	M	M	L	L
CO 4	S	M	L	L	-	M	M	M	L	M	M	M	L	M
CO 5	S	M	L	M	-	M	M	M	-	S	M	M	M	M
CO 6	S	M	L	M	-	M	M	M	-	S	M	M	M	M

S- Strong; M-Medium; L-Low

Assessment Pattern: Cognitive Domain

Cognitive Levels	Continuous Assessment Tests			Assignment			Terminal Examination
	1	2	3	1	2	3	
Remember	20	20	20	-	-	-	20
Understand	60	40	20	-	-	-	20
Apply	20	40	60	10	10	10	60
Analyse	0	0	0	-	-	-	0
Evaluate	0	0	0	-	-	-	0
Create	0	0	0	-	-	-	0

Assessment Pattern: Psychomotor

Psychomotor Skill	Miniproject /Assignment/Practical Component
Perception	--
Set	--
Guided Response	30
Mechanism	70
Complex Overt Responses	--
Adaptation	--
Origination	--

Sample Questions for Course Outcome Assessment**

Course Outcome 1 (CO1):

1. Discuss the phenomenon of sulphate attack on concrete mentioning the methods to minimize the same
2. Differentiate between the terms Repair, Rehabilitation and Retrofitting
3. Define the term permeability. List the factors affecting permeability of concrete

Course Outcome 2 (CO2):

1. Discuss the mechanism of corrosion in rebars and discuss the influencing factors
2. Mention if cover thickness is related to corrosion of rebars? if so how?
3. List the types of distress that are likely to affect a break water structure discussing the causes and effects

Course Outcome 3 (CO3):

1. Name two NDT tests of assessing quality of concrete
2. By means of a flow chart discuss the method of diagnosing distress in concrete structures
3. Which special concrete you would recommend for a concrete structure to be constructed in freezing climatic conditions and why? Also discuss the properties of such a concrete

Course Outcome 4 (CO4):

1. Discuss the various methods of corrosion protection of rebars
2. Define the term quality assurance and mention its need
3. As a quality assurance engineer identify and discuss the components you would include in devising a new quality assurance scheme for a new organization.

Course Outcome 5 (CO5):

1. How do you make concrete buried under polluted ground resistant to corrosion? Discuss the various methods
2. Discuss a method of strengthening of a concrete beam. Discuss the properties of the materials used in the strengthening method
3. Which is the special concrete you would recommend for a concrete water tank and why? Give suitable reasoning discussing its features
4. What is the concreting technique you would recommend for a marine bridge pier construction? Justify and discuss its salient features

Course Outcome 6 (CO6):

1. Present a brief note on foamed concrete and vacuum concrete.
2. Discuss any two rehabilitation techniques adopted in RCC buildings.
3. Explain the repairing Procedure for the structural members when it is distressed in different conditions.

Concept Map

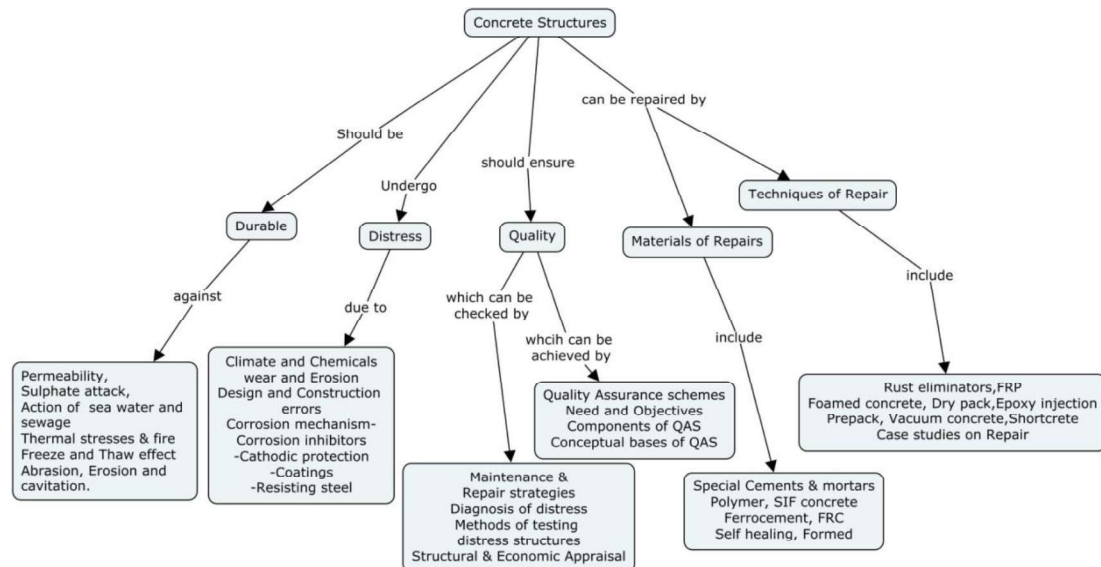

Syllabus

Durability of Concrete Structures - Permeability of concrete- Sulphate attack – methods of control – durability of concrete in sea water- action of sewage – thermal properties of concrete

– fire resistance – resistance to freezing and thawing – resistance to abrasion, erosion and cavitation. **Distress in concrete structures- causes, effects and remedial measures-** effects due to climate, temperature, chemicals, wear and erosion, design and construction errors, corrosion mechanism, effects of cover thickness and cracking, methods of corrosion protection, inhibitors, resistant steels, coatings, cathodic protection. **Maintenance and Repair Strategies -** Inspection, structural appraisal, economic appraisal- Diagnosis of distress – Procedure. **Quality assurance** – need- components- conceptual bases of quality assurance schemes. **Materials for Repair** – Special concretes and mortars, special cements for accelerated strength gain, expansive cement, polymer concrete, sulphur infiltrated concrete, ferro-cement, fibre reinforced concrete, self healing concrete, formed concrete, Fibre reinforced Polymers. **Techniques of Repair** – Rust eliminators and polymer coating for rebars during repair, foamed concrete, mortar and dry pack, prepack, vacuum concrete, gunite and shotcrete, epoxy injection, mortar repair for cracks – case studies on distress concrete structures and type of treatment done.

Learning Resources

1. Dension Campbell, Allen and, Harold Roper, “ Concrete Structures, Materials, Maintenance and Repair”, Longman Scientific and Technical Publications UK, 1991
2. R.N.Raikar, “Building Failures: Diagnosis and avoidance”, Structwel Designers & Consultants, R & D Centre (1994)
3. Shetty. M.S., “Concrete Technology – Theory and Practice”, S.Chand Company, New Delhi, 2010
4. “Handbook on Repair and Rehabilitation of RCC Buildings” by Central Public Works Department, New Delhi, MoUD, Govt of India, 2011.
5. NPTEL course on Structural Health Monitoring: <https://nptel.ac.in/courses/114106046/>
6. Robert T. Ratay “Forensic Structural Engineering Handbook, Second Edition” 2010, the McGraw-Hill Companies, Inc ISBN: 9780071498845.
7. Lecture notes on “Three days workshop on "Condition Assessment and Rehabilitation of Structures (CARS 2017)" at National Institute of Technology, WARANGAL(NITWarangal), 17-03-2017 to 19-03-2017

Course Contents and Lecture Schedule

Module No.	Topics	No. of Hours	Course Outcome
1.	Durability of Concrete Structures		
1.1	Permeability of concrete- factors influencing, methods of improving impermeable characteristics	1	CO1
1.2	Sulphate attack – influencing factors & methods of control	1	
1.3	Durability of concrete in sea water- action of sewage – influencing factors	1	
1.4	Thermal properties of concrete – fire resistance - factors influencing	1	
1.5	Resistance to freezing and thawing- influencing factors	1	
1.6	Resistance to abrasion, erosion and cavitation – influencing factors		
2.	Distress in concrete structures- causes, effects and remedial measures		
2.1	Effects due to climate, temperature, chemicals - causes, effects and remedial measure	1	
2.2	Wear and erosion- causes, effects and remedial measure	1	

2.3	Design and construction errors –causes, effects and remedial measure	1	CO2
2.4	Corrosion mechanism, types of corrosion, effects of cover thickness and cracking- influencing factors. Methods of corrosion protection, inhibitors, resistant steels, coatings, cathodic protection	2	
3.0	Quality of Concrete Structures		
3.1	Maintenance and Repair Strategies		
3.1.1	Inspection, types of maintenance, structural appraisal, economic appraisal Diagnosis of distress – Procedure	2	CO3
3.1.2	Methods of assessing the quality of concrete – NDT and DT tests	1	
3.1.3	Structural Appraisal & Economic Appraisal	1	
3.2	Quality assurance		
3.2.1	Need and Objectives- people benefited by QAS	1	CO4
3.2.2	Components, Conceptual bases of quality assurance schemes	2	
3.2.3	Basic methods of development and operation of QAS	1	
4.	Materials for Repair		
4.1	Special concretes and mortars, special cements for accelerated strength gain, expansive cement – properties, methods of manufacture and applications	2	CO5
4.2	Polymer concrete, sulphur infiltrated concrete- properties, methods of manufacture and applications	2	
4.3	Ferro-cement, fibre reinforced concrete- properties, methods of manufacture and applications	2	
4.4	Self healing concrete, formed concrete, Fibre reinforced Polymers - properties, methods of manufacture and applications	3	
5.	Techniques of Repair		
5.1	Rust eliminators and polymer coating for rebars during repair	2	CO6
5.2	Foamed concrete, mortar and dry pack, epoxy injection, mortar repair for cracks	2	
5.3	Prepack, vacuum concrete, gunite and shotcrete – procedure and applications	2	
5.4	Case studies on distress concrete structures and type of treatment done Forensic investigations – case studies	3	
Total Periods		36	

Course Designers:

1. Dr. G.Chitra gcciv@tce.edu
2. D.Rajkumar rajkumarcivil@tce.edu

18CEPT0	ENGINEERING HYDROLOGY				
	Category	L	T	P	Credit
	PE	2	1	0	3

Preamble

It is the science that deals with the waters of the earth, their occurrence, circulation, distribution and their reaction with environment including their relation to living things

Prerequisite

Course Outcomes

On the successful completion of the course students will be able to

CO Number	Course Outcome Statement	Weightage*** in %
CO1	Demonstrate the importance of hydrological cycle and make the measurement of rainfall data.	30
CO2	Compute the losses viz evaporation, evapotranspiration and infiltration for a catchment area.	20
CO3	Calculate the quantity of runoff generated from a catchment.	10
CO4	Illustrate the hydrographs to measure the stream flow.	15
CO5	Compute flood flows and use suitable control measures.	10
CO6	Suggest methods of conserving surface and groundwater.	15

*** Weightage depends on Bloom's Level, number of contact hours,

CO Mapping with CDIO Curriculum Framework

CO #	TCE Proficiency Scale	Learning Domain Level			CDIO Curricular Components (X.Y.Z)
		Cognitive	Affective	Psychomotor	
CO1	TPS3	Apply	Value	Mechanism	1.1.1,2.1.1
CO2	TPS3	Apply	Value	Mechanism	1.1.1,2.1.3
CO3	TPS3	Apply	Value	Mechanism	1.1.1,2.1.3,2.2.4
CO4	TPS3	Apply	Value	Mechanism	1.1.1,2.1.5,2.2.1
CO5	TPS3	Apply	Value	Mechanism	1.1.1,3.2.5
CO6	TPS3	Apply	Value	Mechanism	1.1.1,2.1.5,2.2.1,3.1.1,3.2.5

Mapping with Programme Outcomes and Programme Specific Outcomes

Cos	PO1	PO2	PO3	PO4	PO5	PO6	PO7	PO8	PO9	PO10	PO11	PO12	PSO1	PSO2
CO1	S	M	L	----	----	M	M	----	M	S	----	M	L	M
CO2	S	M	L	----	----	L	L	----	M	L	----	----	L	L
CO3	S	M	L	----	----	M	L	----	M	M	----	----	L	L
CO4	S	M	L	----	----	L	M	----	M	L	----	M	L	L
CO5	S	M	L	----	----	S	M	----	M	S	----	M	L	M
CO6	S	M	L	----	----	S	M	----	M	M	----	----	L	L

S- Strong; M-Medium; L-Low

Assessment Pattern: Cognitive Domain

Cognitive Levels	Continuous Assessment Tests			Assignment			Terminal Examination
	1	2	3	1	2	3	
Remember	20	20	20	-	-	-	20
Understand	40	30	30	-	-	-	30
Apply	40	50	50	100	100	100	50
Analyse	-	-	-	-	-	-	-
Evaluate	-	-	-	-	-	-	-
Create	-	-	-	-	-	-	-

Assessment Pattern: Psychomotor

Psychomotor Skill	Miniproject /Assignment/Practical Component
Perception	-
Set	-
Guided Response	
Mechanism	100
Complex Overt Responses	-
Adaptation	-
Origination	-

Sample Questions for Course Outcome Assessment**

Course Outcome1(CO1):

- Describe the principle of working of a tipping bucket type recording rain gauge with a neat sketch. What are its advantages and disadvantages?
- How is the double mass curve techniques used to check the consistency and adjust the rainfall record at a suspicious station?
- A catchment has six rain gauge station. In a year, the annual rainfall recorded by the gauges are given below. For a 10% error in the estimation of the mean rainfall, calculate the optimum number of stations in the catchment.

Station	A	B	C	D	E	F
Rainfall (cm)	120.2	118.6	119.3	125.2	100.2	119.9

Course Outcome2(CO2):

- A 6h storm produced rainfall intensities of 7, 18, 25, 12, 10, and 3mm/h in successive one hour intervals over a basin of 800 sq.km. The resulting runoff is observed to be 2640 hectare-metres. Determine Φ -index for the basin.
- Write down the most common empirical formula used to calculate evaporation from a water body also explain the factors influencing evaporation.
- Estimate the daily evaporation from a small reservoir using Horton and Mayer equations from the following data:
Water surface temperature=24°C, Air temperature=26°C, Atmospheric pressure=752 mm of mercury, Relative humidity=46%, Wind speed at 0.5m above ground=25.3 km/h, Saturation vapour pressure (water)=22.43mm of mercury, Saturation vapour pressure (air)=25.27mm of mercury.

Course Outcome3(CO3):

- What is base flow ?
- Explain the various factors affecting the runoff
- Draw the typical hydrograph and mention its components. Explain the methods of base flow separation.

Course Outcome 4 (CO4):

- The ordinates of 4 hour unit hydrograph are given below. Determine the ordinates of 12 hr unit hydrograph.

Time (hr)	0	2	4	6	8	10	12	14	16	18	20	22	24	26	28
Ordinates in m ³ /s	0	13	21	24	18	15	12	10	8.3	6.5	5	4	3	1	0

2. Describe the step by step procedure of the derivation of a unit hydrograph from an isolated storm.

3. What is S-hydrograph?

Course Outcome 5 (CO5):

1. What is a design flood?
2. Define MPF.
3. What are the different types flood control methods? Explain

Course Outcome6(CO6):

1. Distinguish natural and artificial recharge of groundwater. Enumerate different methods adopted for recharging the groundwater.
2. Enumerate the methods which are used for determining the yield of a well. Discuss briefly.
3. List the different types of aquifers and also explain their properties.

Concept Map

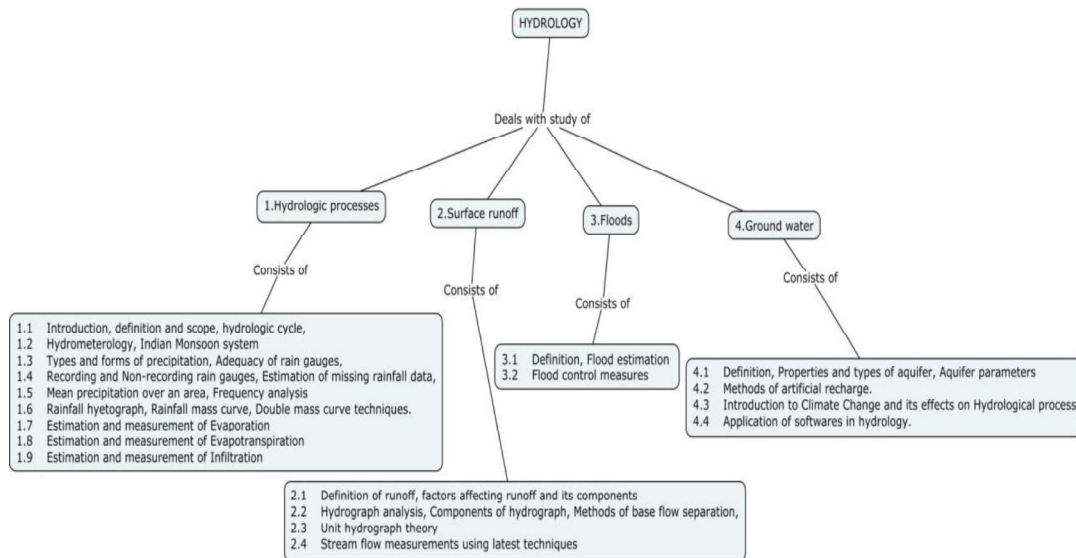

Syllabus

Hydrologic processes: Introduction, definition and scope, hydrologic cycle, Hydrometeorology, Indian Monsoon system, Types and forms of precipitation, Adequacy of rain gauges, Recording and Non-recording rain gauges, Estimation of missing rainfall data, Mean precipitation over an area, Frequency analysis, Rainfall hyetograph, Rainfall mass curve, Double mass curve techniques. Estimation and measurement of Evaporation, Evapotranspiration and Infiltration.

Surface runoff: Definition of runoff, factors affecting runoff and its components, Hydrograph analysis, Components of hydrograph, Methods of base flow separation, Unit hydrograph and Stream flow measurements using latest techniques. **Floods:** Definition, Flood estimation and its control. **Ground water:** Definition, Properties and types of aquifer, Aquifer parameters, Methods of artificial recharge. Introduction to Climate Change and its effects on Hydrological process.

Application of software in hydrology.

Learning Resources

1. Subramanya.K., Engineering Hydrology, Tata McGraw Hill, New Delhi, 2013
2. JayaramiReddy.P. Hydrology, Tata McGraw Hill, New Delhi, 2011.
3. Rangunath.H. Hydrology, Wiley Eastern Limited, New Delhi, 2010.
4. VenTe. Chow, Maidment D.R. and Mays L.W. Applied Hydrology, McGraw Hill International Book Company New York, 1995.
5. VenTe Chow, Hand book of Applied Hydrology, McGraw Hill Book Co., Inc., New York, 1964.

Course Contents and Lecture Schedule

Module No.	Topic	No. of Lectures	Course Outcome	
1	Hydrologic processes		CO1	
1.1	Introduction, definition and scope, hydrologic cycle,	1		
1.2	Hydrometeorology, Indian Monsoon system	1		
1.3	Types and forms of precipitation, Adequacy of rain gauges,	1		
1.4	Recording and Non-recording rain gauges, Estimation of missing rainfall data,	2		
1.5	Mean precipitation over an area, Frequency analysis	2		
	Tutorial	2		
1.6	Rainfall hyetograph, Rainfall mass curve, Double mass curve techniques.	1		
	Tutorial	2		
1.7	Estimation and measurement of Evaporation	2		CO2
	Tutorial	2		
1.8	Estimation and measurement of Evapotranspiration	1		
1.9	Estimation and measurement of Infiltration	1		
2	Surface runoff			
2.1	Definition of runoff, factors affecting runoff and its components	1		CO3
2.2	Hydrograph analysis, Components of hydrograph, Methods of base flow separation,	1		
		Tutorial		2
2.3	Unit hydrograph theory	2	CO4	
		Tutorial		2
2.4	Stream flow measurements using latest techniques	1		
3	Floods			
3.1	Definition, Flood estimation	2	CO5	
3.2	Flood control measures	1		
4	Ground water			
4.1	Definition, Properties and types of aquifer, Aquifer parameters	1	CO6	
		Tutorial		2
4.2	Methods of artificial recharge.	1		
4.3	Introduction to Climate Change and its effects on Hydrological process	1		
4.4	Application of software in hydrology.	1		
Total Hours(24Hrs+12Hrs)		36		

Course Designers:

1. Mr.M.Ramasamy mrciv@tce.edu
2. Dr.T.Baskaran tciv@tce.edu

18CEPU0	AIRWAYS AND WATERWAYS				
	Category	L	T	P	Credit
	PE	3	0	0	3

Preamble

The student develops skills on airport planning and design with the prime focus on runway and taxiway geometrics. Students become conversant with the definition, purpose, location and materials of coastal structures such as piers, breakwaters, wharves, jetties, quays and fenders. The students acquire knowledge on site reconnaissance for location and planning of harbours.

Prerequisite

NIL

Course Outcomes

On the successful completion of the course students will be able to

CO Number	Course Outcome Statement	Weightage*** in %
CO1	Understand the basics of airport planning and its importance in national development	20
CO2	Plan and design various components of airports	25
CO3	Describe the concept of visual aids and Air traffic control services.	15
CO4	Apply knowledge on planning of components of harbours to suggest a appropriate layout	20
CO5	Gain knowledge on different types of docks and its functions	10
CO6	Select the suitable types of navigational aids	10

*** Weightage depends on Bloom's Level, number of contact hours,

CO Mapping with CDIO Curriculum Framework

CO #	TCE Proficiency Scale	Learning Domain Level			CDIO Curricular Components (X.Y.Z)
		Cognitive	Affective	Psychomotor	
CO1	TPS2	Understand	Respond	Guided Response	1.1.1, 1.1.2, 2.1.1, 2.4.3, 2.4.6, 3.3.1
CO2	TPS3	Apply	Value	Mechanism	1.1.1, 1.1.2, 2.1.1, 2.4.3, 2.5.1, 3.2.5, 3.3.1, 4.1.2, 4.4.3
CO3	TPS2	Understand	Respond	Guided Response	1.1.1, 1.1.2, 2.1.1, 2.4.3, 2.5.4, 3.2.5, 3.3.1, 4.4.2, 4.5.1
CO4	TPS3	Apply	Value	Mechanism	1.1.1, 1.1.2, 2.1.1, 2.4.3, 2.5.1, 2.5.4, 3.3.1, 4.1.2, 4.4.3, 4.5.1
CO5	TPS2	Understand	Respond	Guided Response	1.1.1, 1.1.2, 2.1.1, 2.4.3, 2.5.1, 2.5.4, 3.2.5, 3.3.1, 4.1.2, 4.5.1
CO6	TPS3	Apply	Value	Mechanism	1.1.1, 1.1.2, 2.1.1, 2.4.3, 2.4.6, 3.3.1

Mapping with Programme Outcomes and Programme Specific Outcomes

Cos	PO1	PO2	PO3	PO4	PO5	PO6	PO7	PO8	PO9	PO10	PO11	PO12	PSO1	PSO2
-----	-----	-----	-----	-----	-----	-----	-----	-----	-----	------	------	------	------	------

CO1	M	L	-	-	-	M	S	M	M	-	M	M	L	M
CO2	S	M	L	-	-	S	-	S	S	-	S	S	L	M
CO3	M	L	-	-	-	M	S	M	M	-	M	M	L	M
CO4	S	M	L	-	-	S	-	S	S	-	S	S	L	M
CO5	M	L	-	-	-	M	S	M	M	-	M	M	L	M
CO6	S	M	L	-	-	S	-	S	S	-	S	S	L	M

S- Strong; M-Medium; L-Low

Assessment Pattern: Cognitive Domain

Cognitive Levels	Continuous Assessment Tests			Assignment			Terminal Examination
	1	2	3	1	2	3	
Remember	-	-	-	-	-	-	-
Understand	40	40	40	40	40	40	40
Apply	60	60	60	60	60	60	60
Analyse							
Evaluate							
Create							

Assessment Pattern: Psychomotor

Psychomotor Skill	Mini project/Assignment/Practical Component
Perception	-
Set	-
Guided Response	50
Mechanism	50
Complex Overt Responses	-
Adaptation	-
Orignation	-

Sample Questions for Course Outcome Assessment**

** (2 to 3 at the cognitive level of course outcome)

Course Outcome 1(CO1):

1. Discuss in brief the historical development of air transport.
2. Explain the various survey to be conducted and the data to be collected for airport site selection.
3. Enumerate the various factors to be kept in view in selection of site for airports.

Course Outcome 2(CO2):

1. The proposed longitudinal section along the centre line of a runway is as follows:

Station to station	Gradient in percent
0.00 to 8.00	+1.25
8.00 to 15.00	-1.00
15.00 to 30.00	+0.50
30.00 to 45.00	+0.20
45.00 to 60.00	-0.40

If stations are located at a regular interval of 30m, determine the effective gradient of the runway.

2. The wind data obtained from on airport site over a period of 4 years are given below. Draw windrose diagram (Type I) to a suitable scale on a graph paper. Determine calm period, the best orientation of runways and the total wind coverage.

Wind direction	N	NNE	NE	ENE	E	ESE	SE	SSE	S	SSW	SW	WSW	W	WNW	NW	NNW
Total %age of time	7.6	11.3	7.1	3.7	1.5	0.8	0.5	5.1	8.5	15.3	12.5	5.8	3.4	0.6	0.5	4.0

3. A taxiway is to be provided for a supersonic transport which has following characteristics. Determining the turning radius of the taxiway. Wheel base= 35 m. Tread of main loading gear =7.1m. Turning speed = 55kmph. Co-efficient of friction between tire and pavement surface=0.14.

Course Outcome 3(CO3):

1. Discuss the requirements and functions of runway marking system.
2. Describe the Concept of Instrumental Landing System .(ILS) in airways.
3. Describe in brief the need of air traffic control.

Course Outcome 4 (CO4):

1. Sketch the layout of a harbour and explain its components.
2. Classify different types of breakwaters.
3. State the requirements of a good port site.

Course Outcome 5 (CO5):

1. Explain about Dry Docks and Wet docks and Also their classification.
2. Classify different types of Repair docks. Explain any one in brief.
3. State the necessity of docks.

Course Outcome 6(CO6):

1. Sketch the figure of navigational aids and discuss its functions in guiding the ship to the berth.
2. Paraphrase the various on-shore mooring accessories of ships with the help of a neat sketch.
3. Describe the significance of dredging.

Concept Map

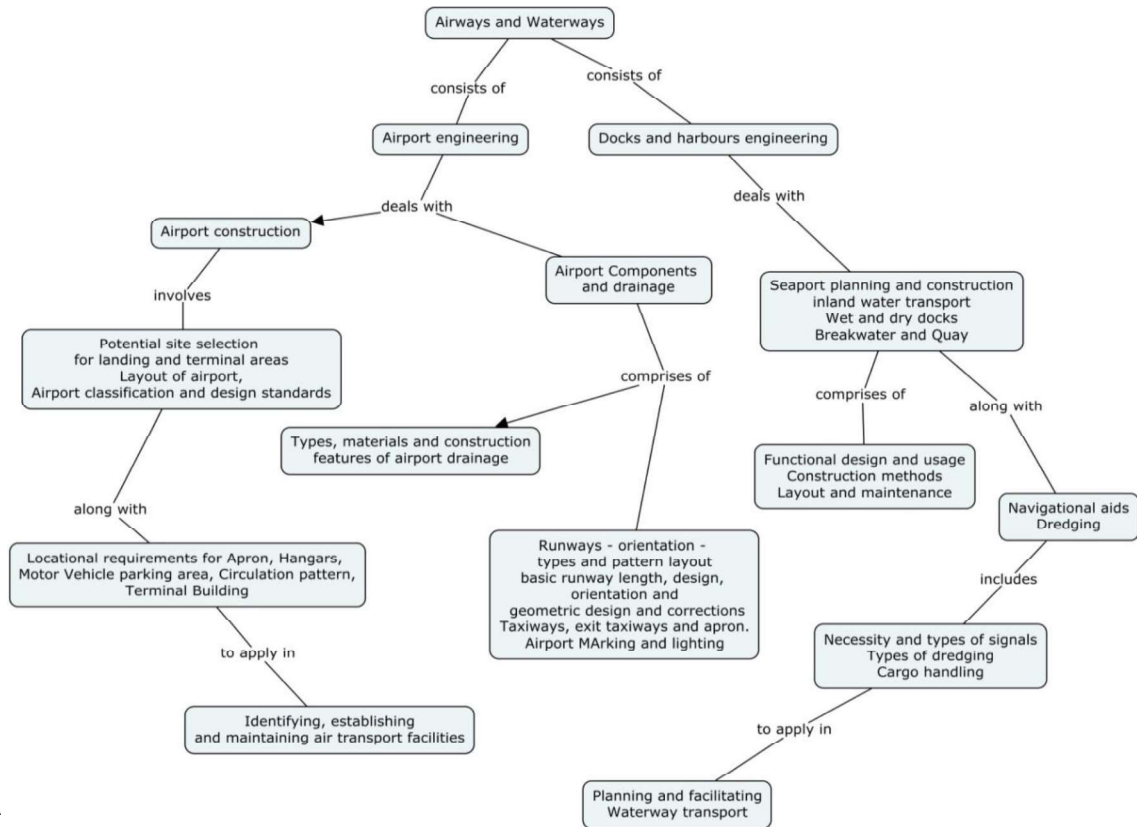

Syllabus

Airport planning: Role of air transport - Components of airports- Airport Planning, Site Selection
Design of Airport components :Runway Design - Orientation, Cross wind Component, Wind rose Diagram, Geometric Design, Taxiway, Airport Drainage - Airport Zoning, Clearance over Highways and Railways, Airport Layouts – Apron, Terminal Building, Hangars, Motor Vehicle Parking Area and Circulation Pattern, Case studies of Airport Layouts - Airport Buildings - Planning Concepts.
Visual aids and Air Traffic Control:Airport marking and lighting-Need of Air Traffic Control-Air Traffic Control Network-Air Traffic control Aids.
Harbours and Docks : Definition of Terms - Harbours, Ports, Docks, Tides and Waves, Littoral Drift, Sounding, Area, Depth, Satellite Ports, Requirements and Classification of Harbours – Site Selection & Selection Investigation – Speed of water, Range of Tides, Waves and Tidal Currents, Anchoring Grounds, Geological Characteristics, Shore Considerations - Proximity to Towns/Cities, Utilities, – Coastal Structures- Breakwaters, Wharves- Dry and Wet Docks, Planning and Layouts, **Navigational aids and dredging:** Navigating - Mooring Accessories, Navigational Aids-Dredging.

Textbooks

1. Rangwala, Airport Engineering, Charotar Publishing House, 2016.
2. S P Bindra, A Course in Docks and Harbour Engineering, Dhanpat Rai and Sons, New Delhi, 2012.
3. Khanna.S.K. Arora.M.G and Jain.S.S, Airport Planning and Design, Nem Chand and Bros , Roorkee, 6th Edition, 2009.

References

1. Rao G.V., Airport Engineering, Tata Mc Graw Hill, New Delhi, 1992.
2. Seetharaman, “Dock & Harbour Engineering”, 1st Edition, Umesh Publications, 2008.

Course Contents and Lecture Schedule

Module No.	Topic	No. of Hours	Course Outcome
------------	-------	--------------	----------------

1.	Airport planning		
1.1	Role of Air Transport, Components of Airports	1	CO1
1.2	Airport Planning – Air traffic potential, Site Selection	2	CO1
2.	Design of Airport components		
2.1	Runway Design- Orientation, Cross wind Component, Wind rose Diagram	3	CO2
2.2	Geometric Design and Corrections for Gradients	2	CO2
2.3	Taxiway Design – Geometric Design Elements, Minimum Separation Distances, Design Speed	2	CO2
2.4	Airport Drainage - Airport Zoning - Clear Zone, Approach Zone, Buffer Zone, Turning Zone, Clearance over Highways and Railways	2	CO2
2.5	Airport Layouts – Apron, Terminal Building, Hangars, Motor Vehicle Parking Area and Circulation Pattern,	1	CO2
2.6	Airport Buildings – Primary functions, Planning Concept, Principles of Passenger Flow, Passenger Facilities	1	CO2
3.	Visual aids and Air Traffic Control		
3.1	Visual Aids - Runway and Taxiway marking, Wind Direction Indicators, Runway and Taxiway Lightings.	2	CO3
3.2	Air Traffic Control – Basic Action, Air Traffic Control Network- Control within terminal area, Control over airways, Airway Communication	2	CO3
3.3	Air Traffic control Aids - Enroute aids and landing aids, Helipads, Hangars, Service Equipments	2	CO3
4.	Harbour and Docks		
4.1	Definition of Terms - Harbours, Ports, Docks, Tides and Waves, Littoral Drift, Sounding, Area, Depth	2	CO4
4.2	Satellite Ports - Requirements and Classification of Harbours – Site Selection	2	CO4
4.3	Selection Investigation – Speed of water, Range of Tides, Waves and Tidal Currents, Littoral Transport with Erosion and Deposition	2	CO4
4.4	Shore Considerations- Proximity to Towns/Cities, Utilities, Coastal Structures – Breakwaters, Wharves	2	CO4
4.5	Dry and Wet Docks, Planning and Layouts - Entrance	4	CO5
5.	Navigational aids and Dredging		
5.1	Necessity and types of signals including floating signals – buoys and beacons- mooring and mooring accessories	2	CO6
5.2	Types of dredging and its applications.	2	CO6
	Total hours	36	

Course Designers:

1. Dr.R.Velkennedy rvkciv@tce.edu
2. Ms.S.Ayswarya saciv@tce.edu

18CEPV0	COMPUTATIONALMETHODS IN STRUCTURAL ANALYSIS	Category	L	T	P	Credit
		PE	3	0	0	3

Preamble

It is common practice to use approximate solutions of differential equations as the basis for structural analysis. This is usually done using numerical approximation techniques. The most commonly used numerical approximation in structural analysis is the Finite Element Method. This course endeavours to fulfil two principal objectives. First, it acquaints matrix methods of structural analysis and their underlying concepts and principles. After a thorough presentation of mathematical tools and theory required for linear elastic analysis of structural systems, the course focuses flexibility and stiffness methods of analysis for computer usage. The direct stiffness method is the backbone of most computer programs is also discussed. Besides, the physical behavior of structures is analysed throughout with the help of axial thrust, shear force, bending moment and deflected shape diagrams.

Prerequisite

18CE220 - Engineering Mechanics, 18CE320 - Mechanics of Solids, 18CE420-Structural Analysis.

Course Outcomes

On the successful completion of the course students will be able to

CO Number	Course Outcome Statement	Weightage*** in %
CO1	Compute the internal moment and by establishing BMD for beams and frames by flexibility method	20%
CO2	Solve for member forces of trusses and grids by flexibility method	15%
CO3	Calculate the internal moment and the resultant BMD of beams, frames using stiffness method	15%
CO4	Resolve the member forces of trusses and grids by stiffness method	15%
CO5	Solve for the internal forces and construct the BMD for Beams and plane frames by direct stiffness method	20%
CO6	Prepare the member forces report for the trusses and grids by direct stiffness method	15%

*** Weightage depends on Bloom's Level, number of contact hours,

CO Mapping with CDIO Curriculum Framework

CO #	TCE Proficiency Scale	Learning Domain Level			CDIO Curricular Components (X.Y.Z)
		Cognitive	Affective	Psychomotor	
CO1	TPS3	Apply	Value	Mechanism	1.1.1,2.1.1,4.4.1,3.2.5,4.4.2,4.4.3,
CO2	TPS3	Apply	Value	Mechanism	1.1.1,2.1.1,4.4.1,3.2.5,4.4.2,4.4.3,
CO3	TPS3	Apply	Value	Mechanism	1.1.1,2.1.1,4.4.1,3.2.5,4.4.2,4.4.3,
CO4	TPS3	Apply	Value	Mechanism	1.1.1,2.1.1,4.4.1,3.2.5,4.4.2,4.4.3,
CO5	TPS3	Apply	Value	Mechanism	1.1.1,2.1.1,4.4.1,3.2.5,4.4.2,4.4.3,
CO6	TPS3	Apply	Value	Mechanism	1.1.1,2.1.1,4.4.1,3.2.5,4.4.2,4.4.3,

Mapping with Programme Outcomes and Programme Specific Outcomes

Cos	PO1	PO2	PO3	PO4	PO5	PO6	PO7	PO8	PO9	PO10	PO11	PO12	PSO1	PSO2
CO 1	S	M	L	-	M	-	-	-	-	-	M	-	M	L
CO 2	S	M	L	-	M	-	-	-	-	-	M	-	M	L
CO 3	S	M	L	-	M	-	-	-	-	-	M	-	M	L
CO 4	S	M	L	-	M	-	-	-	-	-	M	-	M	L
CO 5	S	M	L	-	M	-	-	-	-	-	M	-	M	L
CO 6	S	M	L	-	M	-	-	-	-	-	M	-	M	L

S- Strong; M-Medium; L-Low

Assessment Pattern: Cognitive Domain

Cognitive Levels	Continuous Assessment Tests			Assignment			Terminal Examination
	1	2	3	1	2	3	
Remember				-	-	-	
Understand	20	20	20	-	-	-	20
Apply	80	80	80	100	100	100	80
Analyse							
Evaluate							
Create							

Assessment Pattern: Psychomotor

Psychomotor Skill	Mini project /Assignment/Practical Component
Perception	
Set	
Guided Response	50
Mechanism	50
Complex Overt Responses	
Adaptation	
Origination	

Sample Questions for Course Outcome Assessment**

** (2 to 3 at the cognitive level of course outcome)

Course Outcome1(CO1):

- Analyse the continuous beam shown below by flexibility method.

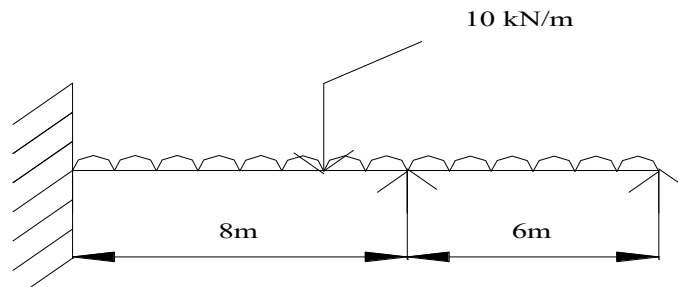

- A cantilever of varying cross section is subjected to a single concentrated load W at the free end as shown in figure-6. Find the deflection at the free end using flexibility method. Also draw the BMD.

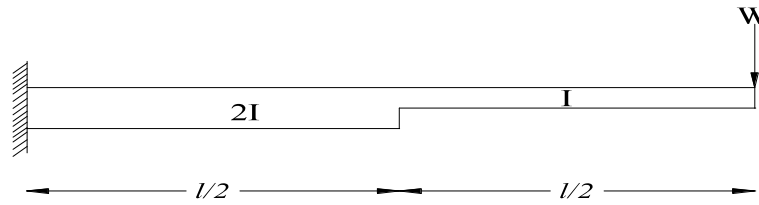
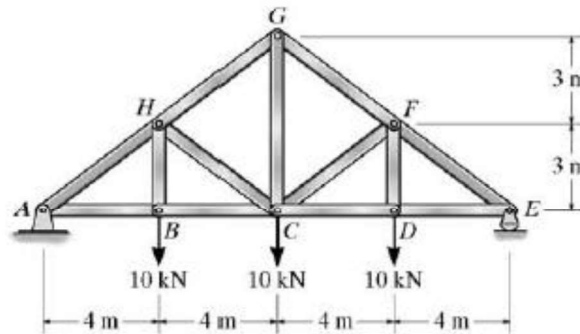

Figure-6

Course Outcome2(CO2):

- Evaluate the member forces of this truss using flexibility method.



Course Outcome3(CO3):

- Find the element stiffness matrix of a truss element shown below.

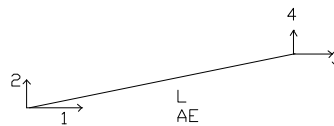

- By displaced method, analyse the continuous beam due to applied load as shown below and the support C sinks by 1cm. Solve for unknown displacement using LDL^T decomposition technique. Take $E = 2 \times 10^5 \text{ Mpa}$ and $I = 374.6 \times 10^6 \text{ mm}^4$

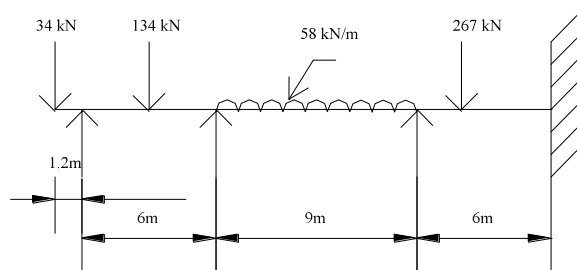

- Analyse the frame using displacement method. The frame is supported at the beam level. Draw the BMD. Assume EI is constant.

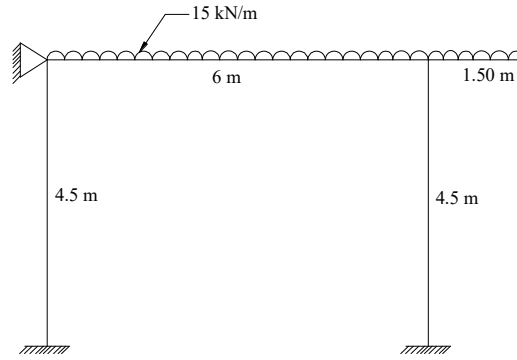
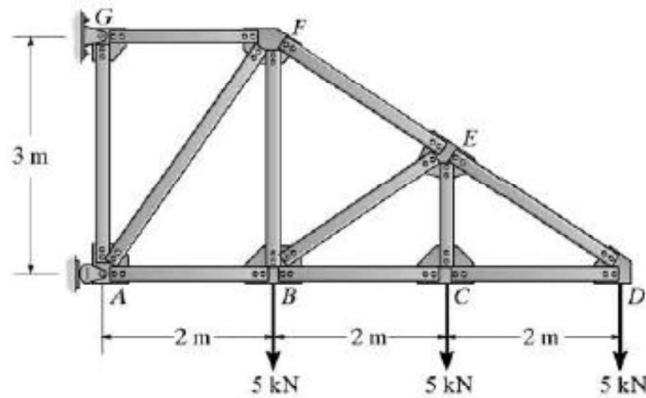

Figure-5

Course Outcome 4 (CO4):

1. Estimate the member forces of this truss using displacement method.



Course Outcome 5 (CO5):

1. Obtain the stiffness matrix of the frame given below by direct stiffness approach.

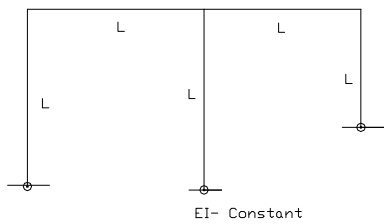

2. Analyse the portal frame subjected to a concentrated load on the beam as shown in figure-1 using direct stiffness method. Draw the BMD.

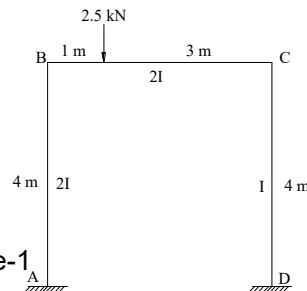
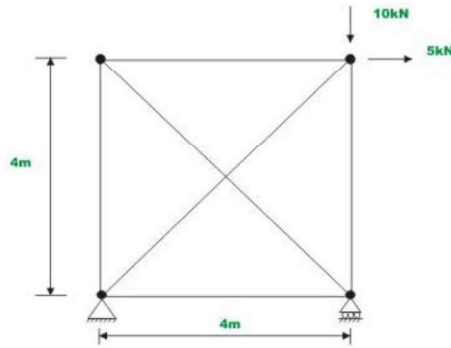

Figure-1

Course Outcome6(CO6):

1. Determine the member forces of this truss using direct stiffness method.



Concept Map

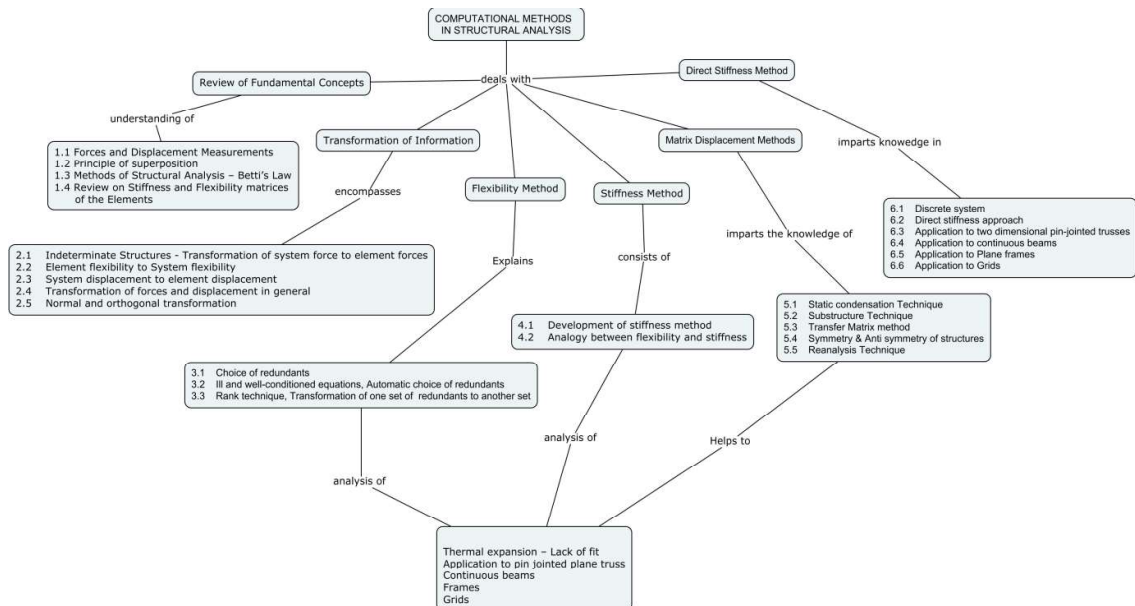

Syllabus

Review of Fundamental Concepts: Introduction – Forces and Displacement relationships – Principle of superposition – Methods of Structural Analysis – Betti’s Law – Stiffness and Flexibility matrices of the Elements – a review. **Transformation of Information:** Indeterminate Structures – Transformation of system force to element forces – Element flexibility to System flexibility – system displacement to element displacement – Transformation of forces and displacement in general – Normal and orthogonal transformation. **Flexibility Method:** Choice of redundant – ill and well-conditioned equations – Automatic choice of redundant – Rank technique – Transformation of one set of redundant to another set – Thermal expansion – Lack of fit – Application to pin jointed plane truss – continuous beams - frames and grids. **Stiffness Method:** Development of stiffness method – analogy between flexibility and stiffness – Analysis due to thermal expansion, lack of fit – Application to pin-jointed plane and space trusses – Continuous beams – frames and grids – problem solving. **Matrix Displacement Methods - Special Topics:** Static condensation Technique – Substructure Technique - Transfer Matrix method – Symmetry & Anti symmetry of structures – Reanalysis Technique. **Direct Stiffness Method:** Discrete system – Direct stiffness approach – Application to beams, plane frames and

two dimensional pin-jointed trusses – Grids.

Learning Resources

1. Rajesekharan & Sankarasubramanian G., “Computational Structural Mechanics”, Prentice Hall of India, 2001.
2. Damodar Maity, “Computer Analysis of Framed Structures”, I K International, 2007
3. Mukhopadhyay M., “Matrix Finite Element Computer and Structural Analysis”, Oxford & IBH, 1984.
4. Reddy C.S., “Basic Structural Analysis”, Tata McGraw Hill Publishing Co.1996.
5. Seeli F.B.& Smith J.P., “Advanced Mechanics of Materials”, John Wiley & Sons, 1993.
6. Smith J.C. “Structural Analysis”, Macmillian Pub.Co.1985.
7. Pezemieniecki, J.S, “Theory of Matrix Structural Analysis”, McGraw Hill Co.,1984.
8. Meek J.L., “Matrix Structural Analysis”, McGraw Hill, 1971.
9. Moshe F Rubinstein– “Matrix Computer Analysis of Structures”– Prentice Hall, 1969.
10. Wang C.K & Solomon C.G.,” Introductory Structural Analysis”, McGraw Hill,1968.
11. Weaver & Gere, “Matrix Analysis of Structures”, 3rd edition, East West Press, 1988.

Course Contents and Lecture Schedule

Module No.	Topic	No. of Lectures
1. Review of Fundamental Concepts		
1.1	Introduction – Forces and Displacement Measurements	1
1.2	Principle of superposition	
1.3	Methods of Structural Analysis – Betti’s Law	1
1.4	Stiffness and Flexibility matrices of the Elements – a review	
2. Transformation of Information		
2.1	Indeterminate Structures - Transformation of system force to element forces	1
2.2	Element flexibility to System flexibility	
2.3	System displacement to element displacement	1
2.4	Transformation of forces and displacement in general	
2.5	Normal and orthogonal transformation	
3. Flexibility Method		
3.1	Choice of redundants	1
3.2	Ill and well-conditioned equations, Automatic choice of redundants	
3.3	Rank technique, Transformation of one set of redundants to another set	1
3.4	Thermal expansion – Lack of fit	
3.5	Application to pin jointed plane truss	2

3.6	Analysis of Continuous beams	2
3.7	Analysis of Frames	2
3.8	Analysis of grids	2
4. Stiffness Method		
4.1	Development of stiffness method	1
4.2	Analogy between flexibility and stiffness	
4.3	Analysis due to thermal expansion, lack of fit	1
4.4	Application to pin-jointed plane trusses	2
4.5	Analysis of Continuous beams	2
4.6	Analysis of Plane Frames	2
4.7	Analysis of Grids	2
5. Matrix Displacement Methods - Special Topics:		
5.1	Static condensation Technique	1
5.2	Substructure Technique	1
5.3	Transfer Matrix method	
5.4	Symmetry & Anti symmetry of structures	1
5.5	Reanalysis Technique	
6. Direct Stiffness Method		
6.1	Discrete system	1
6.2	Direct stiffness approach	
6.3	Application to two dimensional pin-jointed trusses	2
6.4	Application to continuous beams	2
6.5	Application to Plane frames	2
6.6	Application to Grids	2
Total periods		36

Course Designers:

1. Dr.S.Arul Mary samciv@tce.edu
2. G.Celine Reena celinereena@tce.edu

18CERA0	ASEISMIC DESIGN OF STRUCTURES
----------------	--------------------------------------

Category	L	T	P	Credit
PE	3	0	0	3

Preamble

This course offers design of structures subjected seismic forces. This also includes Design concepts of seismic analysis and application using ETABS.

Prerequisite

Dynamics of Structures, RC and Steel structure design

Course Outcomes

On the successful completion of the course, students will be able to

CO Number	Course Outcome Statement	Weightage*** in %
CO1	Apply the SHA to evaluate seismic hazard parameters	20
CO2	Apply theory of vibration to the built structures with external excitation to calculate response on the structure and evaluate liquefaction potential	20
CO3	Analyse the RC structures using IS codes.	25
CO4	Analyse the Steel structures and arrive the residual life estimation of structures using IS codes	15
CO5	Design shear walls using IS codes	10
CO6	Understand the steps to analyse and design the structures using ETABS	10

CO Mapping with CDIO Curriculum Framework

CO #	TCE Proficiency Scale	Learning Domain Level			CDIO Curricular Components (X.Y.Z)
		Cognitive	Affective	Psychomotor	
CO1	TPS3	Apply	Value	Mechanism	1.2,2.1.1
CO2	TPS3	Apply	Value	Mechanism	1.1.1, 1.2, 1.3 , 2.1.3 ,2.1.4, 2.1.5 , 4. 4.1 , 4. 4. 2 , 4.4.3
CO3	TPS3	Apply	Value	Mechanism	1.1.1, 1.2, 1.3 , 2.1.3 ,2.1.4, 2.1.5 , , 4. 4.1 , 4. 4. 2 , 4.4.3
CO4	TPS3	Apply	Value	Mechanism	1.1.1, 1.2, 1.3 , 2.1.3 ,2.1.4, 2.1.5 , , 4. 4.1 , 4. 4. 2 , 4.4.3
CO5	TPS3	Apply	Value	Mechanism	1.1.1, 1.2, 1.3 , 2.1.3 ,2.1.4, 2.1.5 , , 4. 4.1 , 4. 4. 2 , 4.4.3
CO6	TPS2	Understand	Respond	Guided Response	1.1.1, 1.2, 1.3 , 2.1.3 ,2.1.4, 2.1.5 , , 4. 4.1 , 4. 4. 2 , 4.4.3

Mapping with Programme Outcomes

Cos	PO1	PO2	PO3	PO4	PO5	PO6	PO7	PO8	PO9	PO10	PO11	PO12	PSO1	PSO2
CO1	S	M	L	----	----	S	S	S	S	----	S	S	M	M
CO2	S	M	L	----	----	S	S	S	S	----	S	S	M	M
CO3	S	M	L	----	----	S	----	S	S	----	S	S	M	M
CO4	S	M	L	----	----	S	S	S	S	----	S	S	M	M
CO5	S	M	L	----	----	S	S	S	S	----	S	S	M	M
CO6	M	L	----	----	----	M	S	M	M	----	M	M	L	M

S- Strong; M-Medium; L-Low

Assessment Pattern: Cognitive Domain							
Cognitive Levels	Continuous Assessment Tests			Assignment			Terminal Examination
	1	2	3	1	2	3	
Remember	10	10	10	-	-	-	10
Understand	10	10	10	-	-	-	10
Apply	80	80	80	100	100	100	80
Analyse				-	-	-	
Evaluate				-	-	-	
Create							

Assessment Pattern: Psychomotor	
Psychomotor Skill	Miniproject /Assignment/Practical Component
Perception	-
Set	-
Guided Response	-
Mechanism	Assignment
Complex Overt Responses	-
Adaptation	-
Origination	-

Sample Questions for Course Outcome Assessment**

** (2 to 3 at the cognitive level of course outcome)

Course Outcome 1 (CO1):

1. Distinguish the magnitude and intensity of earthquake
2. Describe the two approaches followed for the prediction of earthquakes.
3. Name the major plates of the earth.

Course Outcome 2 (CO2):

1. Define storey drift.
2. Define 'torsional effect' on buildings?
3. Define modal mass and modal participation factor.

Course Outcome 3 (CO3):

1. Explain the concepts and types of Response spectrum. Write step by step procedure of constructing response spectrum diagrams with neat sketch.
2. Design fig 1.a & 1.b by using Response spectrum method. The Free Vibration Properties of the building for vibration in the X-Direction is shown below

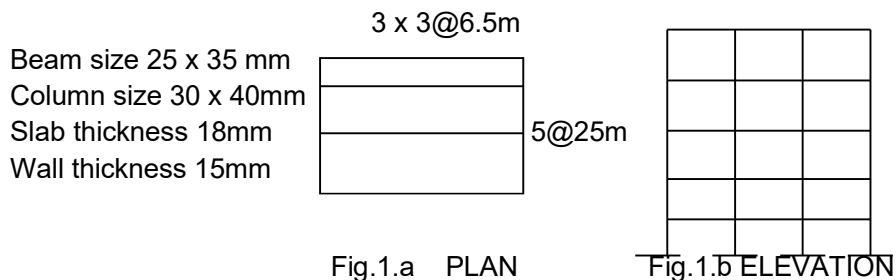

	Mode 1	Mode 2	Mode 3
Natural Period (sec) T	0.765	0.321	0.135
Mode ShapeRoof	1.000	1.000	1.000
3rd Floor	0.924	0.185	-0.731
2nd Floor	0.786	-0.608	-0.528

Concept Map

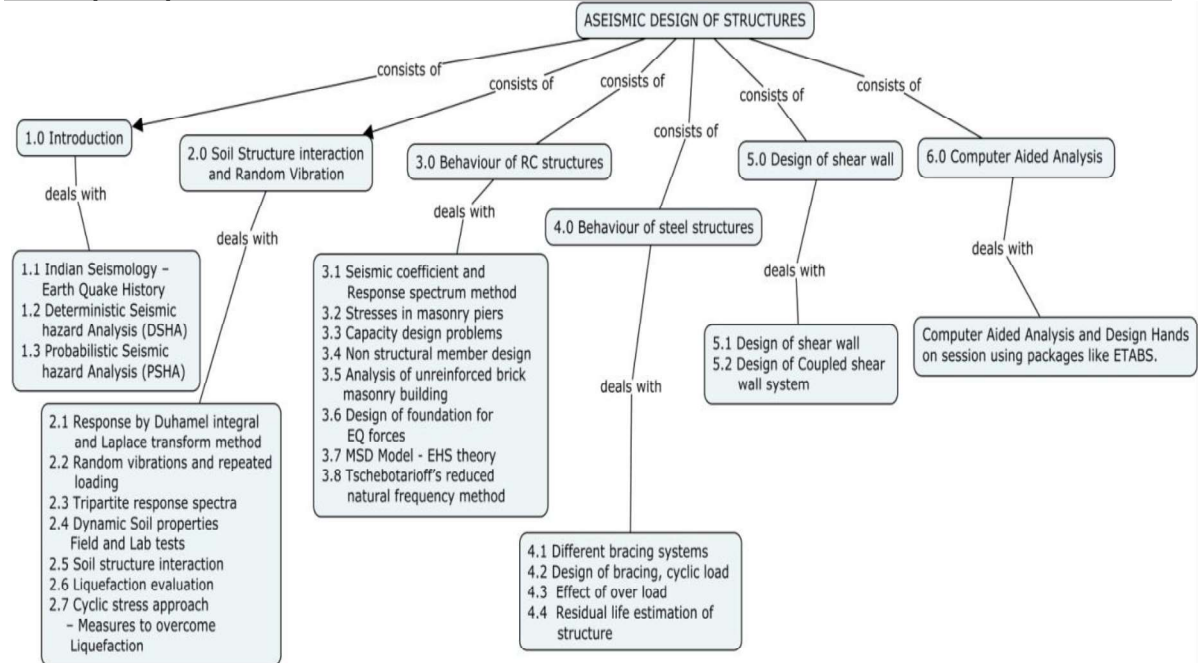

Syllabus

Introduction - Indian Seismology – Earth Quake History Deterministic Seismic Hazard Analysis (DSHA) Probabilistic Seismic hazard Analysis (PSHA) **Soil Structure interaction and Random Vibration** Response by Duhamel integral and Laplace transform method-Response of the structure to random vibrations and repeated loading -Tripartite response spectra problems - Dynamic Soil properties Field and Lab tests-soil structure interaction Liquefaction Problems on Liquefaction evaluation -Cyclic stress approach –Seed and Idriss method – Measures to overcome Liquefaction **Behaviour of RC structures** -Seismic coefficient and Response spectrum method -Analysis of stresses in masonry piers -Capacity design problems-Design of non-structural member -lateral load analysis of un reinforced brick masonry building -Design of shear wall – Khan and Saboronis method -Coupled shear wall system – Rosman’s method - Design of foundation for EQ forces -MSD Model - EHS theory -Tschebotarioff’s reduced natural frequency method **Behaviour of steel structures: Lateral load analysis of steel structure** different bracing systems -design of bracing, cyclic load -Effect of over load -Residual life estimation of structure **Computer Aided Analysis and Design Hands on session using packages like ETABS**

Reference Books

1. Anil.K.Chopra, “Dynamics of Structures” (Theory and Applications to Earthquake Engineering), Prentice Hall of India Private Limited, 2nd Edition, New Delhi, 2003.
2. Clough R W and Penzien J, “Dynamics of structures”, McGraw Hill
3. Jaykrishna, “Elements of earthquake engineering” , Saritha Prakasan, Naunchandi, Meerut.
4. Mukhopadhyay, M., "Structural Dynamics", Ane Books, India, 2006
5. Pankaj Agarwal and Manish Shrikandhe, “Earthquake Resistant Design of Structures”, PHI.
6. Park & Paulay, “Reinforced concrete”, McGraw-Hill.

List of national and international Standard Codes

1. IS:1893 - (Part I), Criteria for Earthquake Resistant structures-General Provisions and Buildings
2. IS:13935 – Repair and Seismic strengthening of buildings
3. IS:4326 - Earthquake Resistant Design and Constructions of buildings
4. IS:13827 – Improving Earthquake Resistance of Earthen buildings

5. IS: 13828 - Improving Earthquake Resistance of Low strength Masonry buildings.
 6. IS: 13920 – Ductile detailing of RC Structures subject to Seismic forces.

Course Contents and Lecture Schedule			
Module No.	Topic	No. of Hours	Course Outcome
1.0	Introduction		
1.1	Indian Seismology – Earth Quake History	1	CO1
1.2	Deterministic Seismic hazard Analysis (DSHA)	2	CO1
1.3	Probabilistic Seismic hazard Analysis (PSHA)	2	CO1
2.0	Soil Structure interaction and Random Vibration		
2.1	Response by Duhamel integral and Laplace transform method	2	CO2
2.2	Response of the structure to random vibrations and repeated loading	2	CO2
2.3	Tripartite response spectra problems	1	CO2
2.4	Dynamic Soil properties Field and Lab tests	1	CO2
2.5	soil structure interaction	2	CO2
2.6	Liquefaction Problems on Liquefaction evaluation	1	CO2
2.7	Cyclic stress approach –Seed and Idriss method – Measures to overcome Liquefaction	1	CO2
3.0	Behaviour of RC structures		
3.1	Seismic coefficient and Response spectrum method	3	CO3
3.2	Analysis of stresses in masonry piers	2	CO3
3.3	Capacity design problems	2	CO3
3.4	Design of non structural member	1	CO3
3.5	lateral load analysis of un reinforced brick masonry building	1	CO3
3.6	Design of foundation for EQ forces	1	CO3
3.7	MSD Model - EHS theory	2	CO3
3.8	Tschebotarioff's reduced natural frequency method	1	CO3
4.0	Behaviour of steel structures: Lateral load analysis of steel structure		
4.1	different bracing systems	1	CO4
4.2	design of bracing, cyclic load	1	CO4
4.3	Effect of over load	1	CO4
4.4	Residual life estimation of structure	1	CO4
5.0	Design of Shear wall		
5.1	Design of shear wall	1	CO5
5.2	Design of Coupled shear wall system	1	CO5
6.0	Computer Aided Analysis and Design Hands on session using packages like ETABS.	2	CO6
	Total Hours	36	

Course Designers:

1. R.Ponnudurai rpdciv@tce.edu
 2. R.Indrajith Krishnan jiith@tce.edu

18CERB0	EXPERIMENTAL TECHNIQUE AND INSTRUMENTATIONS				
	Category	L	T	P	Credit
	PE	3	0	0	3

Preamble

This course offers various experimental techniques and measurements needed for analysis and design of structures. The course covers the basic aspects of experimental stress analysis that includes exhaustive treatment of the most versatile techniques like photo elasticity and strain gauges.

Prerequisite

Strength of materials

Course Outcomes

On the successful completion of the course students will be able to

CO Number	Course Outcome Statement	Weightage*** in %
CO1	Understand the principles of operation of different types of strain gauges	10
CO2	Apply the principle to operation of the strain gauges into various structural engineering problems	25
CO3	Apply the photo elasticity theory to stress analysis.	25
CO4	Understand various NDT technique and its principle of operation	10
CO5	Apply the principle of model analysis to prototype structure.	10
CO6	Apply the various instruments involved in the measurement of vibration parameters	20

*** Weightage depends on Bloom's Level, number of contact hours,

CO Mapping with CDIO Curriculum Framework

CO #	TCE Proficiency Scale	Learning Domain Level			CDIO Curricular Components (X.Y.Z)
		Cognitive	Affective	Psychomotor	
CO1	TPS2	Understand	Respond	Guided Response	1.2,2.1.1
CO2	TPS3	Apply	Value	Mechanism	1.1.1, 1.2, 1.3, 2.1.3 ,2.1.4, 2.1.5 , 4. 4.1 , 4. 4. 2 , 4.4.3
CO3	TPS3	Apply	Value	Mechanism	1.1.1, 1.2, 1.3, 2.1.3 ,2.1.4, 2.1.5 , , 4. 4.1 , 4. 4. 2 , 4.4.3
CO4	TPS2	Understand	Respond	Guided Response	1.1.1, 1.2, 1.3, 2.1.3 ,2.1.4, 2.1.5 , , 4. 4.1 , 4. 4. 2 , 4.4.3
CO5	TPS3	Apply	Value	Mechanism	1.1.1, 1.2, 1.3, 2.1.3 ,2.1.4, 2.1.5 , , 4. 4.1 , 4. 4. 2 , 4.4.3
CO6	TPS3	Apply	Value	Mechanism	1.1.1, 1.2, 1.3, 2.1.3 ,2.1.4, 2.1.5 , , 4. 4.1 , 4. 4. 2 , 4.4.3

Mapping with Programme Outcomes and Programme Specific Outcomes

Cos	PO1	PO2	PO3	PO4	PO5	PO6	PO7	PO8	PO9	PO10	PO11	PO12	PSO1	PSO2
CO1	M	L	----	----	----	M	S	M	M	----	M	M	L	M
CO2	S	M	L	----	----	S	S	S	S	----	S	S	M	S
CO3	S	M	L	----	----	S	----	S	S	----	S	S	M	M
CO4	M	L	----	----	----	M	S	M	M	----	M	M	L	M
CO5	S	M	L	----	----	S	S	S	S	----	S	S	M	S
CO6	S	M	L	----	----	S	S	S	S	----	S	S	M	S

S- Strong; M-Medium; L-Low

Assessment Pattern: Cognitive Domain

Cognitive Levels	Continuous Assessment Tests			Assignment			Terminal Examination
	1	2	3	1	2	3	
Remember	10	10	10	-	-	-	10
Understand	10	10	10	-	-	-	10
Apply	80	80	80	100	100	100	80
Analyse				-	-	-	
Evaluate				-	-	-	
Create				-	-	-	

Assessment Pattern: Psychomotor

Psychomotor Skill	Mini project /Assignment/Practical Component
Perception	-
Set	-
Guided Response	-
Mechanism	Assignment
Complex Overt Responses	-
Adaptation	-
Origination	-

Sample Questions for Course Outcome Assessment**

** (2 to 3 at the cognitive level of course outcome)

Course Outcome1(CO1):

1. Define cross sensitivity
2. List the types of strain gauges
3. Brief the principle of operation mechanical strain gauge
4. Explain the principle of Strain gauge Rosettes. Compare the available Rosettes and their applications.

Course Outcome2(CO2):

1. Four strain gauges, each of 100Ω resistance and gauge factor 2.0, are mounted on a steel cantilever and connected to Wheatstone bridge circuit as shown in fig. The bridge supply voltage is 6V. Find bridge output voltage, when a force of 100N is applied at the free end of the cantilever. $E=20 \times 10^{10} \text{ N/m}^2$.

2. What do you understand by temperature compensation in connection with the electrical resistance strain gauge? Explain clearly the terms, selected melt gauges, dual element gauges and adjacent arm compensation

Course Outcome3(CO3):

1. Explain the elements of a plane polariscope. What are the difference between isoclinic and isochromatic fringes?
2. Explain the effect of a stressed model in a standard circular polarscope using Jones calculus
3. Derive the condition for extinction of light in crossed-crossed circular polariscope arrangement with monochromatic light source and stressed model, placed in the middle.

Course Outcome 4 (CO4):

1. Explain the principle of operation of Impact Echo method
2. Brief how Ground penetrating Radar helps to investigate the failures
3. Explain how cracks are determined by using Radiographic testing

Course Outcome 5 (CO5):

1. Differentiate direct and indirect model analysis
2. Elaborate how moment deformater provides ILD for BM at internal sections of a model

Course Outcome6(CO6):

1. Derive a general expression for the output voltage of Wheatstone Bridge circuit for different strain gauge combinations
2. Explain the principle of Strain gauge Transducers. With the help of neat sketch,
3. Explain the application of strain gauges in Load cells and Torque Transducers.

Concept Map

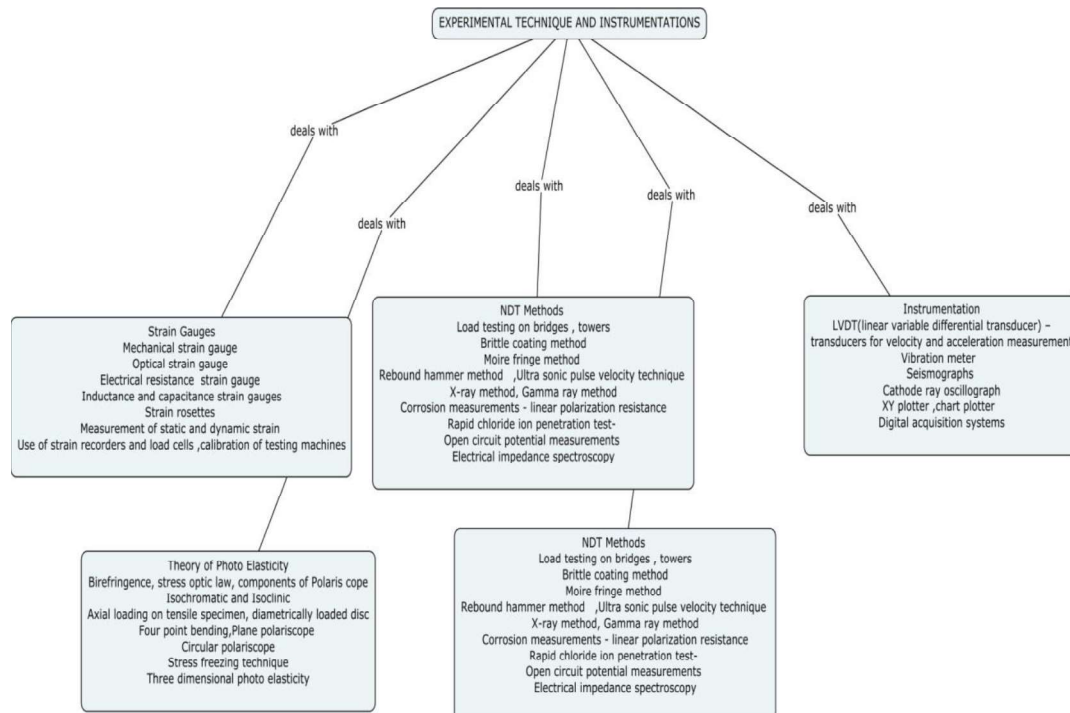

Syllabus

Strain Gauges Mechanical strain gauge -Optical strain gauge - Electrical resistance strain gauge - Inductance and capacitance strain gauges - Strain rosettes -Wheat stone bridge - load cells, Torque meterdynamic strain measurements- Maxwell's bridge, Hay's bridge - Kelvin's double bridge Wein bridge**Theory of Photo Elasticity** - Birefringence, stress optic law, components of Polaris cope - Isochromatic and Isoclinic - Axial loading on tensile specimen diametrically loaded disc- Four point bending,Plane polariscope- Circular polariscope**NDT Methods** - Rebound hammer method, Ultra sonic pulse velocity technique - Liquid penetrant testing, surface crack detection - Acoustic emission Techniques - Infrared and thermal testing - X-ray method, Gamma ray method - Corrosion measurements - linear polarization resistance - Rapid chloride ion penetration test**Model Analysis** Structural similitude- Structural similitude - Structural and dimensional analysis - Buckingham pi theorem ,Muller Breslau's principle - Direct and indirect analysis , **Instrumentation**- LVDT(linear variable differential transducer) – transducers for velocity and acceleration measurement- Vibration meter - Seismographs- Cathode ray oscillograph - XY plotter ,chart plotter - Digital acquisition systems

Learning Resources

1. Dalley .J.W and Riley.W.F, "Experimental Stress Analysis", McGraw Hill Book Company, N.Y.1991.
2. K.K.Ramesh, Digital Photoelasticity – Advanced Techniques and Applications, Springer, 2000.
3. W.N.Sharpe (Ed), Springer Handbook of Experimental Solid Mechanics, Springer, 2008.
4. L.S. Srinath, M.R. Raghavan, K. Lingaiah, G. Gargesa, B. Pant, and K. Ramachandra, Experimental Stress Analysis, Tata Mc Graw Hill, 1984.
5. Ganesan.T.P, "Model Analysis of Structures", University Press, India, 2000.
6. Ravisankar.K and Chellappan.A., "Advanced Course on Non-Destructive Testing and Evaluation of Concrete Structures", SERC, Chennai, 2007.
7. Sadhu Singh, "Experimental Stress Analysis", Khanna Publishers, New Delhi, 2006.
8. Sirohi.R.S., Radhakrishna.H.C, "Mechanical Measurements", New Age International (P) Ltd. 1997.

Course Contents and Lecture Schedule

Module No.	Topic	No. of Hours	Course Outcome
1	Strain Gauges		
1.1	Mechanical strain gauge	1	CO1
1.2	Optical strain gauge	1	CO1
1.3	Electrical resistance strain gauge	1	CO2
1.4	Inductance and capacitance strain gauges	1	CO2
1.5	Strain rosettes	1	CO2
1.6	Wheat stone bridge	1	CO2
1.7	load cells ,Torque meter	1	CO2
1.8	dynamic strain measurements	1	CO2
1.9	Maxwell's bridge, Hay's bridge,	1	CO2
1.10	Kelvin's double bridge Wein bridge	1	CO2
2	Theory of Photo Elasticity		
2.1	Birefringence, stress optic law, components of Polaris cope	1	CO3
2.2	Isochromatic and Isoclinic	1	CO3
2.3	Axial loading on tensile specimen, diametrically loaded disc	1	CO3
2.4	Four-point bending, Plane Polariscope	1	CO3

18CERC0	COMPUTER AIDED DESIGN				
	Category	L	T	P	Credit
	PE	3	0	0	3

Preamble

The syllabus of subject "Computer Aided Design" of structures includes the main concepts of informatics, computer hardware and software, principles for design and types of operational systems (Windows), work with interpreter, compilers and linkage editors. The main aspects of programming with MS Visual C++ considered are: variables and types of data, arithmetical, logical and relational operations, main operators, functions, objects, classes, input-output operators, etc. This course provides the essentials of performing computer-aided design, from engineering rather than a purely mathematical point of view.

Prerequisites

Design of Reinforced Concrete Elements (18CE610), Prestressed Concrete (18CEPF0) and Design of Steel Elements (18CE570)

Course Outcomes

On the successful completion of the course, students will be able to

CO Number	Course Outcome Statement	Weightage*** in %
CO1	Formulate algorithm for solving equations and construct algorithm for truss problems using matrix method	20
CO2	Construct algorithm for design of reinforced concrete members	20
CO3	Construct algorithm for design of steel members	15
CO4	Construct algorithm for analysis of prestressed concrete members	15
CO5	Formulate spread sheet for design of structural elements and quantity estimation	15
CO6	Develop stages of computer aided analysis and design including optimisation	15

*** Weightage depends on Bloom's Level, number of contact hours,

CO Mapping with CDIO Curriculum Framework

CO #	TCE Proficiency Scale	Learning Domain Level			CDIO Curricular Components (X.Y.Z)
		Cognitive	Affective	Psychomotor	
CO1	TPS3	Apply	Value	Mechanism	1.1.1, 2.1.1, 2.1.2, 2.1.5, 2.4.3, 2.4.5, 3.2.2, 3.2.5,
CO2	TPS3	Apply	Value	Mechanism	1.1, 1.2, 1.3, 2.1.1, 2.1.2, 2.1.5, 2.4.3, 3.2.2, 3.2.5,
CO3	TPS3	Apply	Value	Mechanism	1.1.1, 1.2, 1.3, 2.1.2, 2.1.5, 2.4.3, 2.4.5, 3.2.2, 3.2.5,
CO4	TPS3	Apply	Value	Mechanism	1.1.1, 2.1.1, 2.1.2, 2.1.5, 2.4.3, 2.4.5, 3.2.2, 3.2.5,

CO5	TPS3	Apply	Value	Mechanism	1.1.1, 1.2, 1.3, 2.1.1, 2.1.2, 2.1.5, 2.4.3, 3.2.2, 3.2.5,
CO6	TPS3	Apply	Value	Mechanism	1.1.1, 1.2, 1.3, 2.1.1, 2.1.2, 2.1.5, 2.4.3, 2.4.5, 3.2.2,

Mapping with Programme Outcomes and Programme Specific Outcomes

COs	PO1	PO2	PO3	PO4	PO5	PO6	PO7	PO8	PO9	PO10	PO11	PO12	PSO1	PSO2
CO1	S	M	L	-	---	S	M	S	S	---	S	S	M	M
CO2	S	M	L	-	---	S	M	S	S	---	S	S	M	M
CO3	S	M	L	-	---	S	M	S	S	---	S	S	M	M
CO4	S	M	L	-	---	S	M	S	S	---	S	S	M	M
CO5	S	M	L	-	---	S	M	S	S	---	S	S	M	M
CO6	S	M	L	-	---	S	M	S	S	---	S	S	M	M

S- Strong; M-Medium; L-Low

Assessment Pattern: Cognitive Domain

Cognitive Levels	Continuous Assessment Tests			Assignment			Terminal Examination
	1	2	3	1	2	3	
Remember	10	10	10	-	-	-	10
Understand	10	10	10	-	-	-	10
Apply	80	80	80	100	100	100	80
Analyse							
Evaluate							
Create							

Assessment Pattern: Psychomotor

Psychomotor Skill	Assignment
Perception	-
Set	-
Guided Response	50
Mechanism	50
Complex Overt Responses	-
Adaptation	-
Origination	-

Sample Questions for Course Outcome Assessment**

Course Outcome 1 (CO1):

1. Determine the forces in the members of the truss shown in Fig.1 by matrix stiffness method. Take $E = 200\text{GPa}$.

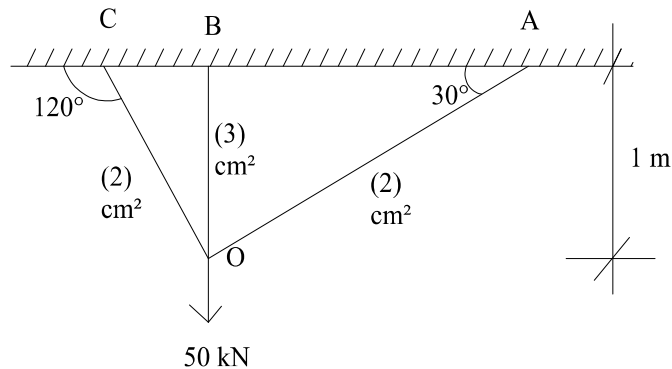

Fig.1

2. Solve the following system of equations by Gauss elimination method.

$$3x_1 - 4x_2 - x_4 = 2$$

$$x_2 + x_3 + 4x_4 = 3$$

$$x_1 - 3x_2 + 6x_3 - 2x_4 = -3$$

$$x_2 + 2x_3 + 3x_4 = -4$$

3. Generate the algorithm for solving simultaneous equations by Gauss Elimination Method.

Course Outcome 2 (CO2):

1. Write the algorithm for determination of bending moment coefficients for two way simply supported slab.
2. Compare the stress-strain relation for mild steel with that of cold formed steel.
3. Write the algorithm for determination of bending moment coefficients for two way simply supported slab

Course Outcome 3 (CO3):

1. Determine the web and flange sections, intermediate and end bearing stiffeners required for a welded plate girder section which will be provided for a hall. The superimposed load exclusive of self weight is 150kN/m . The span of the girder is 20m .
2. Write the algorithm for analysis and design of single and built up steel beam sections.
3. Write the algorithm for design of web and flange section of a welded plate girder.

Course Outcome 4 (CO4):

1. Express the equations for analysis of prestressed concrete members due to self weight and prestress.
2. Compute the stresses at the central section for the following cases for a prestressed concrete beam.

a.) Prestress + self weight (density of concrete = 24 kN/m^3)

b.) Prestress + self weight + live load.

The concrete beam is of symmetrical I-section spanning 8m has flange width and thickness of 200 and 60mm respectively. The overall depth of the beam is 400mm . The thickness of the web is 80mm . The beam is prestressed by a parabolic cable with an eccentricity of 15mm at the centre and zero at the supports with an effective force of 100kN . The live load on the beam is 2kN/m .

3. Outline the algorithm for analyzing prestressed concrete members.

Course Outcome 5 (CO5):

1. Generate the spread sheet for design of one way continuous slab.
2. Write the algorithm for developing spread sheet taking off quantities for various items of works.
3. Outline the algorithm for designing structural elements using spread sheet.

Course Outcome 6 (CO6):

1. List the softwares for analysis and design of structural members.
2. Describe the different stages of computer aided design softwares.
3. Describe the step by step procedure of analysing and designing a two bay two storied portal frame using any computer aided design software.

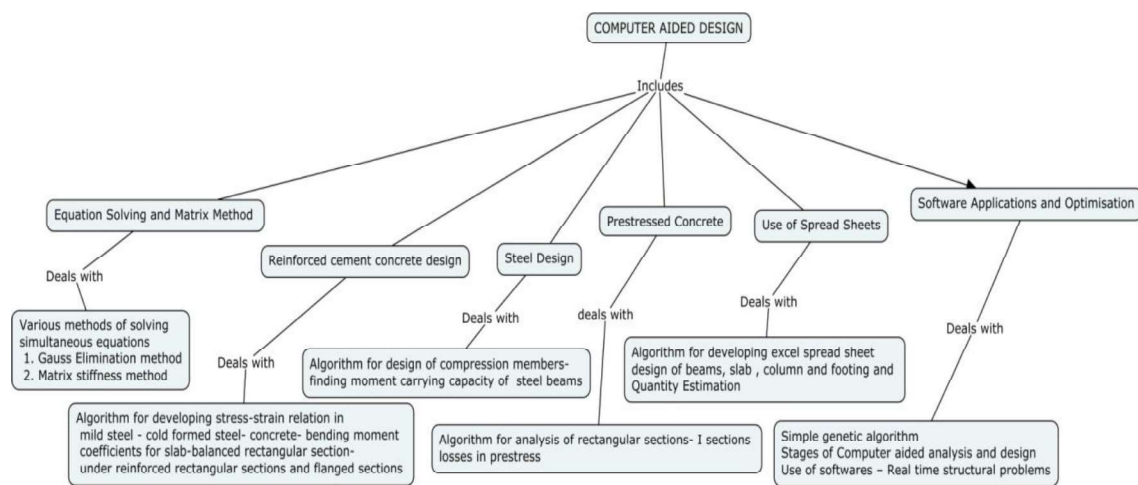
Concept Map**Syllabus**

Equation solving and Matrix method: Algorithm for solving simultaneous equations – Gauss elimination method; banded and semi-banded matrices – local and global coordinate system; element stiffness matrix – structure stiffness matrix – algorithm for solving trusses by matrix stiffness method. **Reinforced cement concrete design:** Algorithm for stress strain relationship in mild steel – cold formed steel – stress-strain relationship in concrete; algorithm for bending moment coefficients in slab; algorithm for developing design tables for beams – rectangular and flanged sections. **Steel design:** Algorithm for analysis and design of compression members; Algorithm for moment carrying capacity of steel beams. **Prestressed concrete:** Algorithm for analysis of prestressed rectangular and I sections in flexure – algorithm for finding losses in prestress. **Spread sheets:** Algorithm for developing spread sheet for various structural elements like beam-slab-column-footing and for quantity estimation. **Software Applications and Optimisation:** Introduction to optimisation – simple genetic algorithm; stages of computer aided analysis and design; Use of softwares to real time structural problems

Learning Resources

1. Krishnamoorthy, C.S and Rajeev, S, "Computer Aided Design", Narosa Publication House, New Delhi, 2005.
2. Krishnaraju N, "Prestressed Concrete", Tata McGraw-Hill, New Delhi, 2006.
3. Pandit G, Gupta, S, "Structural Analysis – A Matrix Approach", McGraw-Hill Education, India, New Delhi, 2008.
4. Peter W, Christensen, A, "An Introduction to Structural Optimisation", Springer 2009.
5. Punmia BC and Jain,A.K, "Comprehensive Design of Steel Structures", Laxmi Publications, 2006.

Course Contents and Lecture Schedule			
Module No.	TOPICS	No of Lectures	Course Outcomes
1. Equation Solving and Matrix Method			
1.1	Introduction	1	CO1
1.2	Various methods of solving simultaneous equations	1	
1.3	Algorithm for solving simultaneous equations by Gauss Elimination method	1	
1.4	Banded and semi-banded matrices	1	
1.5	Element stiffness and structure stiffness matrices	1	
1.6	Algorithm for solving truss problems by matrix stiffness method	2	
2. Reinforced cement concrete design			
2.1	Introduction to interaction curves	1	CO2
2.2	Algorithm for developing stress-strain relation in mild steel	1	
2.3	Algorithm for developing stress-strain relation in cold formed steel	1	
2.4	Algorithm for developing stress-strain relation in concrete	1	
2.5	Algorithm for developing bending moment coefficients for slab	1	
2.6	Algorithm for developing design tables for balanced rectangular sections	2	
2.7	Algorithm for developing design tables for under reinforced rectangular sections and flanged sections	2	
3. Steel Design			
3.1	Introduction	1	CO3
3.2	Algorithm for design of compression members	2	
3.3	Algorithm for finding moment carrying capacity of steel beams	2	
4. Prestressed Concrete			
4.1	Introduction	1	CO4
4.2	Algorithm for analysis of rectangular sections	1	
4.3	Algorithm for analysis of I sections	2	
4.4	Algorithm for finding losses in prestress	2	
5. Use of Spread Sheets			
5.1	Algorithm for developing excel spread sheet – design of beams, slab, column and footing	2	
5.2	Use of excel spread sheet – Quantity Estimation	2	
6. Software Applications and Optimisation			
6.1	Introduction to Optimisation- Simple genetic algorithm	1	CO6
6.2	Stages of Computer aided analysis and design	2	

6.3	Use of softwares – Real time structural problems	2	
	Total	36	

Course Designers:

1. Dr. S.Nagan, nagan_civil@tce.edu
2. R. Sankaranarayanan, rsciv@tce.edu

18CERD0	ANTI-TERRORISM DESIGN OF STRUCTURES				
	Category	L	T	P	Credit
	PE	3	0	0	3

Preamble

Disaster mitigation and its preparedness is the need of current scenarios. Blast induced loads on structures are results of accidents in the industries and also from evil minds. These disasters, if happened, may result devastating effect on infrastructure including operational facilities, buildings, bridges etc. This will not only cause monetary loss but importantly the loss of lives. The course is proposed with an aim of educating students for mitigation of blast effects on structures.

Prerequisite

NIL

Course Outcomes

On the successful completion of the course, students will be able to

CO Number	Course Outcome Statement	Weightage in %
CO1	Explain the fundamentals of blast engineering and related blast dynamics.	15
CO2	Understand the theoretical and practical aspects of the recent advancements made in blast resistant and anti-terrorism design of structures in existing facilities.	15
CO3	Review the high strain rate behavior of material.	10
CO4	Illustrate the characteristics of underground blast and its influence on geological factors.	10
CO5	Plan and Design blast resistant strategies in structural and non structural components using empirical approach and available commercial packages of finite element.	25
CO6	Apply the Indian/international guidelines in design of blast resistant structure for intended level of threat scenario from chosen material.	25

CO Mapping with CDIO Curriculum Framework

CO #	TCE Proficiency Scale	Learning Domain Level			CDIO Curricular Components (X.Y.Z)
		Cognitive	Affective	Psychomotor	
CO1	TPS2	Understand	Respond	Guided Response	1.1.1, 1.2, 2.1.1, 3.1.1
CO2	TPS2	Understand	Respond	Guided Response	1.1.1, 1.1.2, 1.2, 2.3.1
CO3	TPS3	Apply	Value	Mechanism	1.1.1, 1.1.2, 1.2, 2.3.1
CO4	TPS3	Apply	Value	Mechanism	1.1.1, 1.1.2, 1.2, 2.3.1
CO5	TPS3	Apply	Value	Mechanism	1.1.2, 1.2
CO6	TPS3	Apply	Value	Mechanism	1.1.2, 1.2

Mapping with Programme Outcomes and Programme Specific Outcomes

Cos	PO1	PO2	PO3	PO4	PO5	PO6	PO7	PO8	PO9	PO10	PO11	PO12	PSO1	PSO2
CO1	M	L	-	-	-	-	-	-	-	L	-	-	L	L
CO2	M	L	-	-	S	S	-	S	-	L	S	-	L	M
CO3	S	M	L	-	-	-	L	-	L	L	L	-	M	L
CO4	S	M	L	-	L	-	-	M	M	M	M	-	M	L

CO5	S	M	L	-	S	M	-	S	-	M	S	M	M	M
CO6	S	M	L	-	-	S	-	M	-	S	S	S	M	M

S- Strong; M-Medium; L-Low

Assessment Pattern: Cognitive Domain

Cognitive Levels	Continuous Assessment Tests			Assignment			Terminal Examination
	1	2	3	1	2	3	
Remember	20	20	20	-	-	-	20
Understand	60	40	20	-	-	-	20
Apply	20	40	60	10	10	10	60
Analyse	0	0	0	-	-	-	0
Evaluate	0	0	0	-	-	-	0
Create	0	0	0	-	-	-	0

Assessment Pattern: Psychomotor

Psychomotor Skill	Miniproject /Assignment/Practical Component
Perception	--
Set	--
Guided Response	30
Mechanism	70
Complex Overt Responses	--
Adaptation	--
Origination	--

Course Level Assessment Questions

CO1: Explain the fundamentals of blast engineering and related blast dynamics.

1. Define the term: Path of triple point, Mach stem, and vortex.
2. List out the types of Blast loading and its causes.
3. State Buckingham Pi Theorem.

CO2: Understand the theoretical and practical aspects of the recent advancements made in Blast resistant and anti-terrorism design of structures in existing facilities.

1. List out the Limitations in empirical approaches in determination of Blast loading.
2. Describe in detail about sacrificial wall.
3. Calculate the pressure and impulse of various intensities of blast loading.

CO3: Review the high strain rate behavior of materials.

1. Define the term strain rate and categorise the load based on it.
2. Explain about the working principle of Split Hopkinson Pressure Bar test facilities.
3. Investigate the properties of shock absorbing materials.

CO 4: Illustrate the characteristics of underground blast and its influence on geological factors.

1. Determine the behaviour of underground blast induced ground motion using empirical approach.
2. Assess the behaviour of shock wave under various medium.
3. Explain the mechanism of soil liquefaction due to underground explosion.

CO5: Plan and Design blast resistant strategies in structural and non structural components using empirical approach and available commercial packages of finite element.

1. Explain in detail how the controlled demolition techniques can be adopted.

2. Illustrate the mechanism of progressive collapse and discuss the lessons learned from experience.
3. Discuss in detail about blast mitigating strategies.

CO6: Apply the Indian/international guidelines in design of blast resistant structure for intended level of threat scenario from chosen material.

1. Recommend suitable provisions to be included in IS Codes for resisting blast load.
2. Find the gaps in Blast design codal provisions of various countries.
3. Mention the types of polymers, which are used to increase the performance of structure.

Concept Map

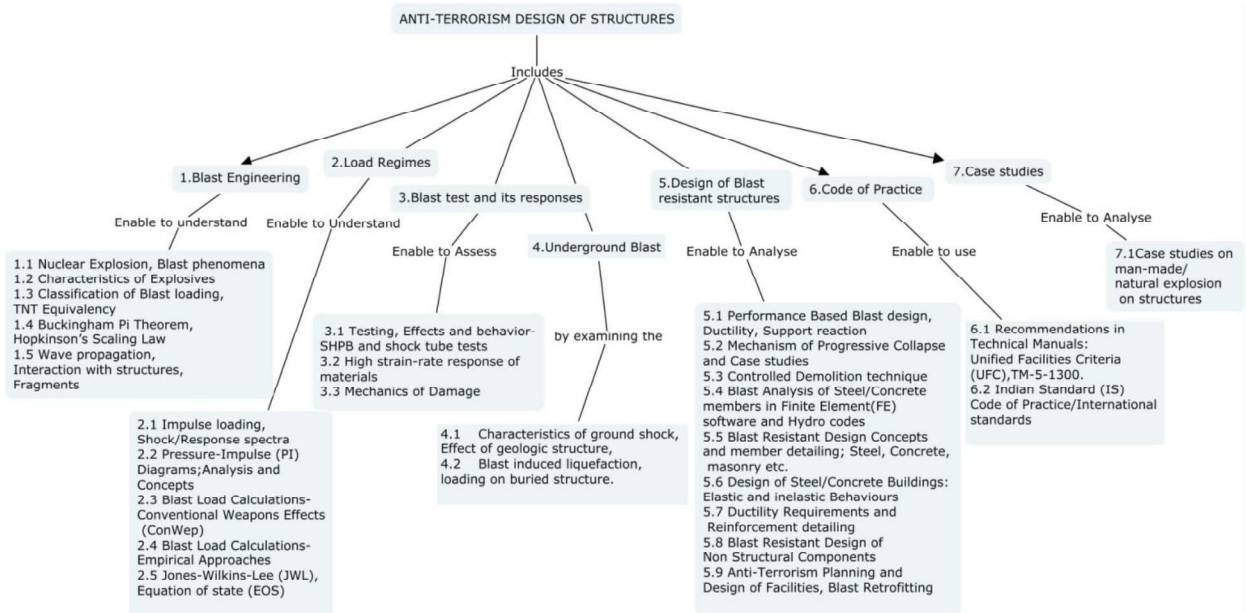

Syllabus

Blast Engineering: Nuclear Explosion, Blast phenomena, Characteristics of Explosives, Classification of Blast loading, TNT Equivalency, Buckingham Pi Theorem, Hopkinson's Scaling Law, Wave propagation, Interaction with structures, Fragments. **Load Regimes:** Impulse loading, Shock/Response spectra, Pressure-Impulse (PI) Diagrams; Analysis and concepts, Blast Load Calculations-Conventional Weapons Effects (ConWep) and Empirical Approaches, Jones-Wilkins-Lee (JWL), Equation of state (EOS) **Blast test and its responses:** Testing, Effects and behavior-SHPB and shock tube tests, High strain-rate response of materials, Assessing the Mechanics of Damage **Underground blast induced ground motion:** Characteristics of ground shock, Effect of geologic structure, blast induced liquefaction, loading on buried structure. **Design of Blast resistant structures:** Performance Based Blast design, Ductility, Support reaction, Mechanism of Progressive Collapse and Case studies, Controlled Demolition technique, Blast Analysis of Steel/Concrete members in Finite Element (FE) software and Hydro codes, Blast Resistant Design Concepts and member detailing- Steel, Concrete, masonry etc, Design of Steel/Concrete Buildings: Elastic and inelastic Behaviours, Ductility Requirements and Reinforcement detailing, Blast Resistant Design of Non Structural Components, Anti-Terrorism Planning and Design of Facilities, Blast Retrofitting. **Code of Practice:** Recommendations in Technical Manuals: Unified Facilities Criteria (UFC), TM-5-1300. Gaps in Indian Standard (IS) Code of Practice/International standards. **Case studies:** Case studies on man-made/natural explosion on structures.

Reference Books

1. Smith, P.D. and Hetherington, J.G. (1994). "Blast and Ballistic Loading of Structures", Oxford, Butterworth-Heinemann.
2. Mays, G.C. and Smith, P.D. (1995). "Blast Effects on Buildings", Thomas Telford Publications, London, UK.
3. Meyers, M.A. (1994). "Dynamic Behavior of Materials", Wiley, New York (NY), USA.
4. Kinney, G.F. and Graham, K.J. (1985). "Explosive Shocks in Air", Springer, Berlin, Germany.
5. Dusenberry, D.O. (2010). "Handbook for Blast Resistant Design of Buildings", John Wiley and Sons, New Jersey (NJ), USA.
6. Krauthammer, T. (2008). "Modern Protective Structures", CRC Press, Boca Raton, Florida (FL), USA.
7. Bangash, M.Y.H. and Bangash, T. (2006). "Explosion-Resistant Buildings Design, Analysis and Case Studies", Springer, Berlin, Germany.
8. Henrych, J. (1979). "The Dynamics of Explosion and Its Use", Elsevier, Amsterdam, Netherlands.
9. Zukas, J.A. (2004). "Introduction to Hydrocodes", Oxford, Elsevier.
10. Goel, M.D. and Matsagar, V.A. (2014). "Blast Resistant Design of Structures", Practice Periodical on Structural Design and Construction, American Society of Civil Engineers (ASCE), Vol. 19, No. 2, Article Number 04014007.
11. D. Rajkumar et al (2019). "A numerical study on parametric analysis of reinforced concrete column under blast loading" Journal of Performance of Constructed Facilities (ASCE), DOI 10.1061/(ASCE)CF.1943-5509.0001382.
12. NPTEL notes-Introduction to Explosions and explosion safety.
13. Lecture notes on 'Five days short term course on "Blast Resistant and Anti-Terrorism Design of Structure using Advanced Materials" at VNIT, Nagpur from 26.08.2019 to 30.08.2019.

List of National and International Standards

1. IS 4991: 1968 Criteria for blast resistant design of structures for explosions above ground.
2. IS 6922: 1973 Criteria for safety and design of structures subjected to underground blasts.
3. Publications by: (1) the Department of Defense (DoD), Unified Facilities Criteria (UFC) Program, Washington, DC, USA; (2) the Federal Emergency Management Agency (FEMA), Washington, DC, USA; (3) the American Society of Civil Engineers (ASCE), Reston, Virginia (VA), USA.

List Of Software

LS-DYNA, ABAQUS

Course Contents and Lecture Schedule

Module No.	Topic	No. of Lectures
1. Blast Engineering		
1.1	Nuclear Explosion, Blast phenomena	1
1.2	Characteristics of Explosives	1
1.3	Classification of Blast loading, TNT Equivalency	1
1.4	Buckingham Pi Theorem, Hopkinson's Scaling Law	1
1.5	Wave propagation, Interaction with structures, Fragments	1
2. Load Regimes		
2.1	Impulse loading, Shock/Response spectra	1
2.2	Pressure-Impulse (PI) Diagrams; Analysis and concepts	1
2.3	Blast Load Calculations-Conventional Weapons Effects (ConWep)	1
2.4	Blast Load Calculations-Empirical Approaches	1

2.5	Jones-Wilkins-Lee (JWL),Equation of state (EOS)	1
3. Blast test and its responses		
3.1	Testing, Effects and behavior-SHPB and shock tube tests	1
3.2	High strain-rate response of materials	1
3.3	Assessing the Mechanics of Damage	1
4. Underground blast induced ground motion:		
4.1	Characteristics of ground shock, Effect of geologic structure,	1
4.2	Blast induced liquefaction, loading on buried structure.	1
5. Design of Blast resistant structures		
5.1	Performance Based Blast design, Ductility, Support reaction	2
5.2	Mechanism of Progressive Collapse and Controlled Demolition technique with Case studies	2
5.3	Blast Analysis of Steel/Concrete members in Finite Element(FE) software and Hydro codes	3
5.4	Blast Resistant Design Concepts and member detailing; Steel, Concrete, masonry etc.	3
5.5	Design of Steel/Concrete Buildings: Elastic and inelastic Behaviours	2
5.6	Ductility Requirements and Reinforcement detailing	2
5.7	Blast Resistant Design of Non Structural Components	2
5.8	Anti-Terrorism Planning and Design of Facilities, Blast Retrofitting	2
6. Code of Practice		
6.1	Recommendations in Technical Manuals: Unified Facilities Criteria (UFC),TM-5-1300.	1
6.2	Gaps in Indian Standard (IS) Code of Practice/International standards	1
7. Case studies		
7.1	Case studies on man-made/natural explosion on structures	1
Total periods		36

Course Designers:

1. D.Rajkumar

rajkumarcivil@tce.edu

18CERE0	RESOURCE AND ENERGY RECOVERY FROM WASTES				
	Category	L	T	P	Credit
	PE	3	0	0	3

Preamble

This course work is focused on recovery of resources and energy from solid waste which includes sludge sedimented from wastewater. The process of material recovery and energy recovery in the form of Thermal, Biofuels and green manure product from the solid waste is covered in detail. The course work also covers several case studies to recycle the usable materials recovered from solid waste with its socio-economic and legal considerations.

Prerequisite

NIL

Course Outcomes

On the successful completion of the course students will be able to

CO Number	Course Outcome Statement	Weightage*** in %
CO1	Understand the various recovery processes and volume reduction processes on generated solid waste	15
CO2	Assess the biological process for transformation of solid waste to useful by-products	15
CO3	Assess the Bio-chemical process for transformation of solid waste to useful by-products.	15
CO4	Assess the Thermo-chemical process for transformation of solid waste to useful by-products.	30
CO5	Analyse the recycling and recovery concepts of various solid wastes and E-waste	15
CO6	Select appropriate technology to recover resources and energy from the waste generated by the community	10

*** Weightage depends on Bloom's Level, number of contact hours,

CO Mapping with CDIO Curriculum Framework

CO #	TCE Proficiency Scale	Learning Domain Level			CDIO Curricular Components (X.Y.Z)
		Cognitive	Affective	Psychomotor	
CO1	TPS2	Understand	Respond	Guided Response	1.1,2.3.1,2.3.2,2.4.4
CO2	TPS3	Apply	Value	Mechanism	1.1,2.3.1,2.3.2,2.4.4,2.4.7,4.1.6,4.4.3
CO3	TPS3	Apply	Value	Mechanism	1.1,2.3.1,2.3.2,2.4.4,2.4.7,4.1.6,4.4.3
CO4	TPS3	Apply	Value	Mechanism	1.1,2.3.1,2.3.2,2.4.4,2.4.7,4.1.6,4.4.3
CO5	TPS3	Apply	Value	Mechanism	1.1,2.3.1,2.3.2,2.4.4,2.4.7,4.1.6,4.4.3
CO6	TPS3	Apply	Value	Mechanism	1.1,2.3.1,2.3.2,2.4.4,2.4.7,4.1.6,4.4.3

Mapping with Programme Outcomes and Programme Specific Outcomes

Cos	PO1	PO2	PO3	PO4	PO5	PO6	PO7	PO8	PO9	PO10	PO11	PO12	PSO1	PSO2
CO1	M	L	-	-	-	L	M	L	L	-	-	L	M	M
CO2	S	M	L	-	-	L	M	-	L	-	-	L	M	M
CO3	S	M	L	-	-	L	M	-	L	-	-	L	M	M

CO4	S	M	L	-	-	L	M	-	L	-	-	L	M	M
CO5	S	M	L	-	-	M	M	M	L	-	-	L	S	M
CO6	S	M	L	-	-	M	M	M	L	-	-	L	S	M

S- Strong; M-Medium; L-Low

Assessment Pattern: Cognitive Domain

Cognitive Levels	Continuous Assessment Tests			Assignment			Terminal Examination
	1	2	3	1	2	3	
Remember	12	12	12	-	-	-	12
Understand	48	48	48	-	-	-	48
Apply	40	40	40	10	10	10	40
Analyse							
Evaluate							
Create							

Assessment Pattern: Psychomotor

Psychomotor Skill	Miniproject/Assignment/Practical Component
Perception	-
Set	-
Guided Response	50
Mechanism	50
Complex Overt Responses	-
Adaptation	-
Origination	-

Sample Questions for Course Outcome Assessment**

** (2 to 3 at the cognitive level of course outcome)

Course Outcome 1 (CO1):

1. State Sustainable Development
2. State the objectives of processing of waste
3. Describe the material and energy flow management

Course Outcome 2 (CO2):

1. Name various methods of composting
2. List the factors affecting composting
3. List the scope and importance of vermi culture

Course Outcome 3 (CO3):

1. State the principles of anaerobic digester
2. Name some toxic substances which affects anaerobic digestion
3. Explain the process of methane generation by anaerobic digestion

Course Outcome 4 (CO4):

1. State the principles of Thermal chemical conversion of waste to energy
2. Explain the process of energy recovery from incineration
3. Describe the process of incineration systems

Course Outcome 5 (CO5):

1. Explain the concept of life cycle approach
2. Explain the process of recycling technologies practiced for various materials
3. Explain the process of recycling technologies of E waste with a case study

Course Outcome 6 (CO6):

1. Discuss the legal considerations for the materials recovered from the E-waste
2. Explore the energy generation potential generated from the market waste.

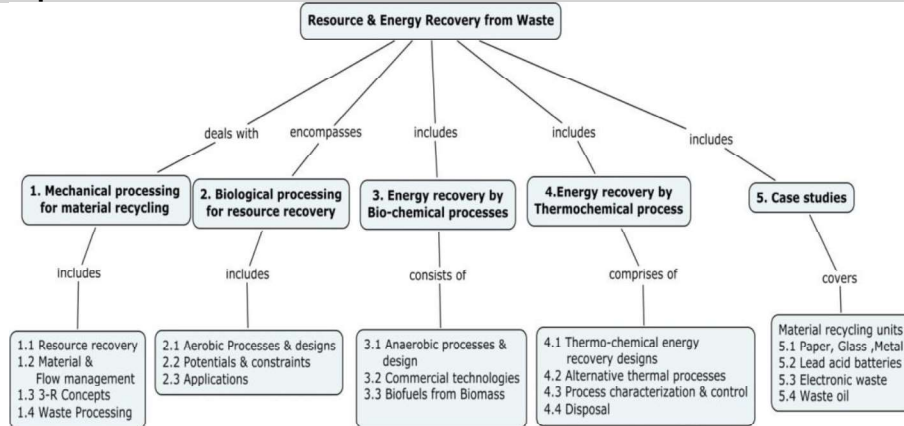
Concept Map**Syllabus**

Mechanical processing for material recycling: Resource recovery for a sustainable development- Material and energy flow management and analysis - Systems and processes for reduction, reuse and recycling - Objectives of Waste processing- Source Segregation and Hand Sorting- Waste Storage and Conveyance – Shredding – Pulping - Size Separation by Screens- Density Separation by Air Classification – magnetic and electromechanical separation processes- Design Criteria and Equipment selection. **Biological processing for resource recovery :** Mechanisms of Biological Processing – Aerobic Processing of Organic fraction – Composting methods and processes- factors affecting- Design of Windrow Composting Systems- In Vessel Composting- Compost Quality Control- Vermiculture: definition, scope and importance – common species for culture - Environmental requirements - culture methods- Applications of vermiculture- Potentials and constraints for composting in India- Large scale and decentralized plants. **Bio-chemical conversion of waste to energy :** Principles and Design of Anaerobic Digesters – Process characterization and control- The biochemistry and microbiology of anaerobic treatment - Toxic substances in anaerobic treatment -Methane generation by Anaerobic Digestion- Anaerobic reactor technologies – Commercial anaerobic Technologies- Single stage and multistage digesters- Digester design and performance- Gas collection systems- Methane Generation and Recovery in Landfills – Biofuels from Biomass. **Thermo-chemical conversion of waste to energy:** Principles and Design of Energy Recovery Facilities -Types and principles of energy conversion processes - Incinerator design - Mass Burn and RDF Systems- Composition and calorific value of fuels and waste, Determination of the stoichiometric air consumption, Calculation of the flue gas composition - grate firing designs, boiler design, removal of bottom ash, heat recovery- Emission Controls – flue gas cleaning, de-dusting, flue gas scrubbers, DeNOx processes, dioxins and furans - Alternative thermal processes: co-incineration, pyrolysis, gasification, plasma arc – Process characterization and control- waste heat recovery- Bottom ash: Quantity, quality, treatment, utilization, disposal- Facility design- decentralized mobile plants- Planning and construction of incineration plants. **Case studies:** Recycling technologies for paper, glass, metal, plastic – Used Lead Acid Battery Recycling – End of Life Vehicle Recycling – Electronic Waste Recycling – Waste Oil Recycling.

Learning Resources

1. Aarne Vesilind and Alan E Rimer (1981), "Unit operations in Resource Recovery Engineering", Prentice Hall Inc., London.
2. Charles R Rhyner (1995), Waste Management and Resource Recovery, Lewis Publishers
3. Chiumenti, Chiumenti, Diaz, Savage, Eggerth, and Goldstein, Modern Composting Technologies, JG Press October 2005.
4. Gary C. Young (2010) Municipal Solid Waste to Energy Conversion Processes: Economic, Technical, and Renewable Comparisons, John Wiley & Sons
5. Manser A G R, Keeling A A (1996). Practical handbook of processing and recycling on municipal waste. Pub CRC Lewis London, ISBN 1-56670-164.

Course Contents and Lecture Schedule			
Module No.	Topic	No. of Hours	Course Outcome
1.0	Mechanical processing for material recycling		
1.1	Resource recovery for a sustainable development	1	CO1
1.2	Material and energy flow management and analysis	1	CO1
1.3	Systems and processes for reduction, reuse and recycling	1	CO1
1.4	Objectives of Waste Processing-Source Segregation and Hand Sorting	1	CO1
1.4.1	Waste Storage and Conveyance – Shredding – Pulping	1	CO1
1.4.2	Size Separation by Screens- Density Separation by Air Classification –magnetic and electromechanical separation processes	1	CO1
1.4.3	Design Criteria and Equipment selection	2	CO6
2.0	Biological processing for resource recovery		
2.1	Mechanisms of Biological Processing – Aerobic Processing of Organic fraction	1	CO2
2.1.1	Composting Methods and processes- factors affecting	1	CO2
2.1.2	Design of Windrow Composting Systems- In Vessel Composting- Compost Quality Control	1	CO2
2.2	Potentials and constraints for composting in India- Largescale and decentralized plants.	1	CO2
2.3	Vermiculture: definition, scope and importance – common species for culture	1	CO2
2.3.1	Environmental requirements - culture methods- Applications of vermiculture	1	CO6
3.0	Bio-chemical conversion of waste to energy		
3.1	Principles and Design of Anaerobic Digesters – Process characterization and control	1	CO3
3.1.1	The biochemistry and microbiology of anaerobic treatment - Toxic substances in anaerobic treatment	1	CO3
3.1.2	Methane generation by Anaerobic Digestion	1	CO3
3.2	Anaerobic reactor technologies – Commercial anaerobic Technologies	1	CO3
3.2.1	Single stage and multistage digesters- Digester design and performance	1	CO3
3.3	Gas collection systems-Methane Generation and Recovery in Landfills – Biofuels from Biomass	1	CO6
4.0	Thermo-chemical conversion of waste to energy		
4.1	Principles and Design of Energy Recovery Facilities	1	CO4
4.1.1	Types and principles of energy conversion Processes	1	CO4
4.1.2	Incinerator design - Mass Burn and RDF Systems-	1	CO4

	Composition and calorific value of fuels and waste,		
4.1.3	Determination of the stoichiometric air consumption, Calculation of the flue gas composition	1	CO4
4.1.4	Grate firing designs, boiler design, removal of bottom ash, heat recovery	1	CO4
4.1.5	Emission Controls – flue gas cleaning, de-dusting, flue gas scrubbers, DeNOx processes, dioxins and furans	1	CO4
4.2	Alternative thermal processes: co-incineration, pyrolysis, gasification, plasma arc	1	CO4
4.3	Process characterization and control- waste heat recovery- Bottom ash: Quantity, quality,	2	CO4
4.4	Bottom ash treatment, utilization, disposal- Facility design- decentralized mobile plants	2	CO4
4.4.1	Planning and construction of incineration plants	1	CO4
5.0	Case studies - Material recycling units		
5.1	Recycling technologies for paper, glass, metal, plastic	1	CO5
5.2	Used Lead Acid Battery Recycling –End of Life Vehicle Recycling	1	CO5
5.3	Electronic Waste Recycling	1	CO5
5.4	Waste Oil Recycling – Solvent Recovery	1	CO5
	TOTAL	36	

Course Designers:

1. Dr. V. Ravishankar
2. Mr. R.K.C. Jeykumar

environmentegr@tce.edu
rkjcciv@tce.edu

18CERF0	INDUSTRIAL WASTE WATER MANAGEMENT			
Category	L	T	P	Credit
PE	3	0	0	3

Preamble

As a fastly growing country, India is flooded with very good numbers of small, medium and large sized industries. The liquid effluent generated from such industries would pose a great danger to the environment, if they are not managed properly. Hence, industrial wastewater management will be of great importance in maintaining the quality of the environment for sustainable living. This course work deals with characterization of industrial effluents, its impact on the environment, possible preventive measures against generation of wastes and treatment and reuse option for the generated wastewater.

Prerequisite

Knowledge on characterization of wastewater (18CE440), physico-chemical treatment and biological treatment.

Course Outcomes

On the successful completion of the course, students will be able to

CO Number	Course Outcome Statement	Weightage*** in %
CO1.	Fix the characteristics of the wastewater generated from any industry and identify factors influencing their generation.	10
CO2.	Identify the means and methods to reduce the quantity of generation of wastewater by implementing Pollution Prevention programme.	20
CO3.	Develop appropriate treatment systems for the wastewater generated from the industries.	20
CO4.	Identify the possible recycling and reuse opportunities for the generated wastewater and residuals by employing suitable treatment units.	20
CO5.	Investigate the feasibility and benefits of individual, common and joint treatment of industrial wastewater.	15
CO6.	Suggest suitable treatment schemes for wastewater generated from specific industries based on their characteristics.	15

*** Weightage depends on Bloom's Level, number of contact hours.

CO Mapping with CDIO Curriculum Framework

CO #	TCE Proficiency Scale	Learning Domain Level			CDIO Curricular Components (X.Y.Z)
		Cognitive	Affective	Psychomotor	
CO1	TPS2	Understand	Respond	Guided Response	1.1.1, 1.1.3, 1.1.4, 1.2, 2.1.3
CO2	TPS3	Apply	Value	Mechanism	1.1.1, 1.1.3, 1.1.4, 1.2, 4.5.6, 4.6.2, 4.6.3
CO3	TPS3	Apply	Value	Mechanism	1.1.1, 1.1.3, 1.1.4, 1.2, 2.3.4
CO4	TPS3	Apply	Value	Mechanism	1.1.1, 1.1.3, 1.1.4, 1.2, 2.5.4
CO5	TPS2	Understand	Respond	Guided Response	1.1.1, 1.1.3, 1.1.4, 1.2, 4.6.5
CO6	TPS3	Apply	Value	Mechanism	1.1.1, 1.1.3, 1.1.4, 1.2, 4.6.5, 3.1.5, 4.1.3

Mapping with Programme Outcomes

COs	PO1	PO2	PO3	PO4	PO5	PO6	PO7	PO8	PO9	PO10	PO11	PO12	PSO1	PSO2
CO1	M	L	-	-	-	-	-	L	M	L	-	L	-	L
CO2	S	M	L	-	-	M	S	M	S	M	S	M	L	S
CO3	S	M	L	-	-	M	M	M	L	L	M	S	L	M
CO4	S	M	L	-	-	S	S	M	M	M	S	S	L	S
CO5	M	L	-	-	-	S	M	M	S	S	S	M	-	S
CO6	S	M	L	-	-	M	M	L	L	L	M	M	L	M

S- Strong; M-Medium; L-Low

Assessment Pattern: Cognitive Domain

Cognitive Levels	Continuous Assessment Tests			Assignment			Terminal Examination
	1	2	3	1	2	3	
Remember	20	20	20	-	-	-	20
Understand	30	30	30	-	-	-	30
Apply	50	50	50	100	100	100	50
Analyse	-	-	-	-	-	-	-
Evaluate	-	-	-	-	-	-	-
Create	-	-	-	-	-	-	-

Assessment Pattern: Psychomotor

Psychomotor Skill	Mini project /Assignment/Practical Component
Perception	-
Set	-
Guided Response	30
Mechanism	70
Complex Overt Responses	-
Adaptation	-
Origination	-

Sample Questions for Course Outcome Assessment****Course Outcome 1(CO1):**

1. Describe the typical impacts of industrial wastewater on water bodies.
2. Discuss the classification of wastewater generated from an industry.

Course Outcome 2(CO2):

1. Explain the importance of population equivalent of an industrial effluent.
2. Illustrate the good operating practices that would lead to pollution prevention.
3. Demonstrate the process of segregation and recovery of waste in waste volume reduction.
4. Perform a waste audit programme in an industry and highlight the various stages involved in it.

Course Outcome 3(CO3):

1. Compute the volume of equalization basin required for the following flow regime.

Time (hrs)	02.00	04.00	06.00	08.00	10.00	12.00	14.00	16.00	18.00	20.00	22.00	24.00
------------	-------	-------	-------	-------	-------	-------	-------	-------	-------	-------	-------	-------

Flow rate (m ³ /d)	8000	6000	9400	12,800	13,000	14,400	12,000	9600	11,000	8000	9000	8400
-------------------------------	------	------	------	--------	--------	--------	--------	------	--------	------	------	------

2. A wastewater is to be treated with activated carbon to remove residual COD. The following data were obtained from a laboratory adsorption study in which 1 g of activated carbon was added to a beaker containing 1 L of wastewater at selected COD values. Using these data, determine the more suitable isotherm.

Initial COD (mg/L)	140	250	300	340	370	400	450
Equilibrium COD (mg/L)	5	12	17	23	29	36	50

3. A wastewater to be desalinated by reverse osmosis using a thin-film composite membrane. Determine the required membrane area, the rejection rate, and the concentration of the concentrate system.

Flowrate	m ³ /d	10,000
Influent TDS	g/m ³	2700
Effluent TDS	g/m ³	225
Flux rate coefficient kw	/sec	1.5x 10 ⁻⁶
Mass transfer rate coefficient, ki	m/s	1.8x 10 ⁻⁶
Net operating pressure	Kpa	3000
Recovery	%	86

Course Outcome 4 (CO4):

1. The sludge production having 96% moisture content from a wastewater treatment plant is 1000 kg on dry solid basis. The solid contain 70% volatile matter with a specific gravity of 1.02 and 30% mineral matter with a specific gravity of 2.5. Determine the volume of raw and digested sludge if reduction in volatile solids is 55% during digestion and moisture content of digested sludge is 92%.
2. Explain the quality requirements for wastewater reuse, suggest a treatment scheme to achieve the above for an Industrial effluent.
3. Explain the role of evaporates in achieving effluent quality requirements.

Course Outcome 5 (CO5):

1. Exhibit the positives and issues in the joint treatment of industrial waste with municipal waste.
2. Identify and explain favorable factors in the common effluent treatment facility.
3. Compare individual treatment with joint treatment and identify the challenges.

Course Outcome 6(CO6):

1. Choose the type of treatment required for wastewater generated from sugar mill and distilleries and justify your answers.
2. Interview the source reduction and wastewater treatment operations in a metal finishing industry.

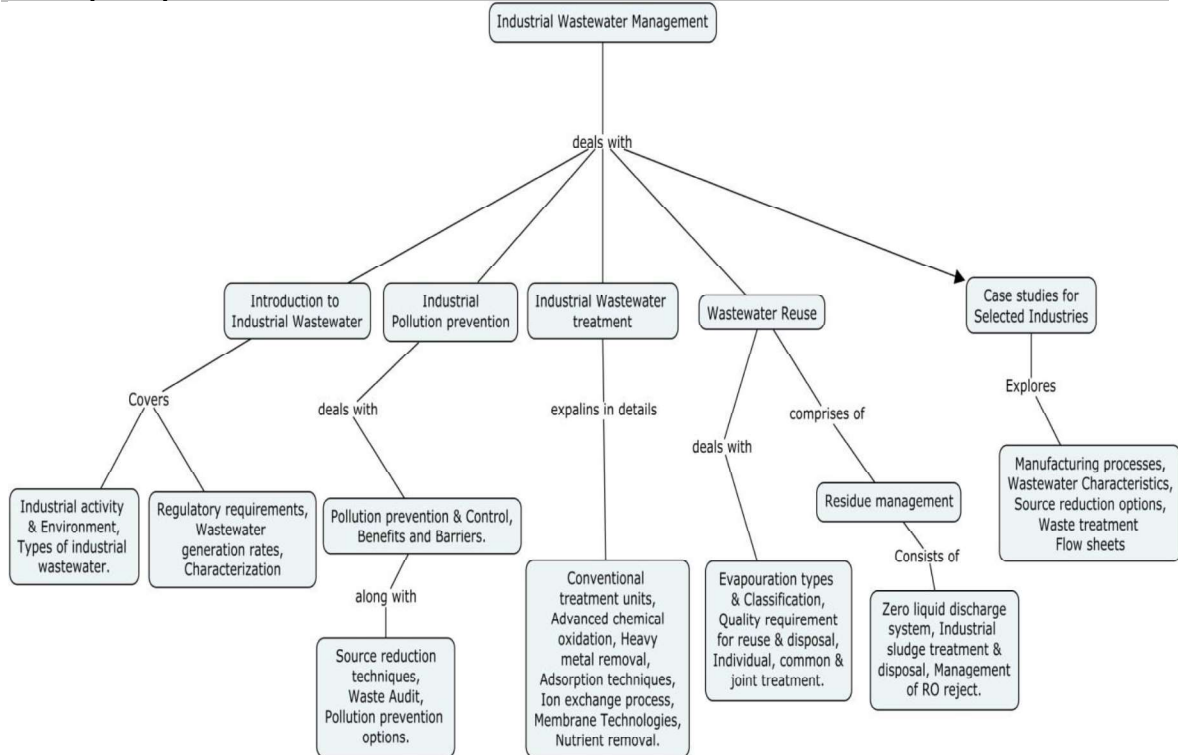
Concept Map**Syllabus**

Introduction to industrial wastewater: Industrial scenario in India – industrial activity and environment, uses of water by industry, sources and types of industrial wastewater. Regulatory requirements for treatment of industrial waste water, industrial waste survey, industrial waste water generation rates, characterization and variables, population equivalent.

Industrial Pollution Prevention: Prevention Vs Control of industrial pollution – benefits and barriers. Source reduction techniques – waste audit, evaluation of pollution prevention options, environmental statement as a tool for pollution prevention, waste minimization circles.

Industrial Wastewater Treatment: Equalization – neutralization, oil separation, flotation, precipitation, Aerobic and anaerobic biological treatment – sequencing batch reactors, high rate reactors (Recall) Advanced Chemical oxidation – Electro chemical oxidation, wet air oxidation, ozonation, photocatalysis, Other Treatment Processes Heavy metal removal, Refractory organics separation by adsorption. ion exchange, membrane technologies, nutrient removal.

Wastewater Reuse and Residual management: Evaporation- Evaporators types and classification. Zero effluent discharge systems - Quality requirements for wastewater reuse, industrial reuse, disposal on water and land. Residuals from industrial wastewater treatment units - quantification and characteristics of sludge - thickening, digestion, conditioning, dewatering and disposal of sludge. Management of RO rejects. Individual and common effluent treatment plants – combined treatment of industrial waste water and domestic/municipal wastewater.

Case Studies: Industrial manufacturing process description, waste water characteristics, source reduction options and waste treatment flow sheet for textiles, tanneries, pulp and paper, metal finishing, sugar and distilleries.

Reference Books

1. Arceivala, S.J., "Wastewater Treatment for Pollution Control", Tata McGraw Hill, 2006.
2. Eckenfelder, W.W., "Industrial Water Pollution Control", McGraw – Hill, 2005.
3. Shirish H. Sonawane., "Innovative Technologies for the Treatment of Industrial Wastewater: A Sustainable Approach", Apple Academic Press, 2017.
4. Vivek V.rande., "Industrial wastewater treatment, Recycling and reuse", Elsevier, 2014.
5. Frank Woodard, Industrial Waste Treatment Handbook, Butterworth Heinemann, New Delhi, 2010.
6. Paul L. Bishop "Pollution Prevention: - Fundamentals and Practice", McGraw – Hill International, 2009.
7. World Bank Group, "Pollution Prevention and Abatement Handbook – Towards Cleaner Production", World Bank and UNEP, Washington.D.C, 1998.

Course Contents and Lecture Schedule

Module No	Topics	No. of Lectures	Course Outcome
1.0	Introduction to industrial wastewater		
1.1	Industrial scenario in India – industrial activity and environment - Uses of water by industry	1	CO1
1.2	Sources and types of industrial wastewater	1	CO1
1.3	Regulatory requirements for treatment of industrial wastewater	1	CO1
1.4	Wastewater generation rates	1	CO1
1.5	Characterization and variables, population equivalent	2	CO1
2.0	Industrial Pollution Prevention		
2.1	Prevention Vs Control of industrial pollution	1	CO2
2.2	Benefits and barriers	1	CO2
2.3	Source reduction techniques	1	CO2
2.4	Waste audit	1	CO2
2.5	Evaluation of pollution prevention option	1	CO2
2.5.1	Environmental statement	1	CO2
2.5.2	Waste minimization circles – PCB Norms for water usage in industries	1	CO2
3.0	Industrial Wastewater Treatment		
3.1	Recall of Conventional treatment system	1	CO3
3.2	Advanced chemical oxidation- Electro-chemical oxidation	1	CO3
3.2.1	Wet air oxidation - Ozonation - Photocatalysis	1	CO3
3.3	Heavy metal removal	1	CO3
3.4	Refractory organics separation by adsorption	1	CO3
3.5	Ion exchange	1	CO3
3.6	Membrane technologies	2	CO3
3.7	Nutrient removal	1	CO3
4.0	Wastewater Reuse and Residual Management		
4.1	Evaporation- Types of evaporators and classification	1	CO4
4.2	Zero effluent discharge systems	1	CO4
4.3	Quality requirement for reuse and disposal	1	CO4
4.4	Quantification and characteristics of sludge	1	CO4
4.4.1	Thickening, digestion, conditioning, dewatering and	2	CO4

	disposal of sludge.		
4.5	Management of RO reject	1	CO5
4.6	Individual, common and joint treatment	2	CO5
5.0	Case Studies		
5.1	Industrial manufacturing processes, wastewater characteristics, Source reduction options and waste treatment flow sheet for textiles, tanneries, pulp and paper, metal finishing, sugar and distilleries.	5	CO6
TOTAL		36	

Course Designers

1. Dr. T. VelRajan
2. Ms. S.Sivasangari

tvziv@tce.edu
ssiciv@tce.edu

18CERG0	SUSTAINABLE MANAGEMENT OF URBAN ECOLOGY	Category	L	T	P	Credit
		PE	3	0	0	3

Preamble

This course provides an overview of various theoretical perspectives, debates and research practices in urban ecology, urban ecosystems, and urban sustainability. This course work covers the concept of sustainable management especially in the urban environment. The future of Urban ecosystems and managing the climate change through the concept of future proofing is also addressed.

Prerequisite

Ecology & Environmental Science (18CHAA0) and Wastewater Engineering (18CE440)

Course Outcomes

On the successful completion of the course students will be able to

CO Number	Course Outcome Statement	Weightage*** in %
CO1	Explain the concept of sustainable development in the urban perspective	10
CO2	Introduce the importance of environmental sustainability	10
CO3	Describe the concept of urban ecology and its framework	25
CO4	Apply the Urban water management tools and models	25
CO5	Illustrate the present scenario in wastewater management and to introduce Eco friendly techniques in managing the same	20
CO6	Develop the future urban ecosystems keeping the climate change as a constraint	10

*** Weightage depends on Bloom's Level, number of contact hours,

CO Mapping with CDIO Curriculum Framework

CO #	TCE Proficiency Scale	Learning Domain Level			CDIO Curricular Components (X.Y.Z)
		Cognitive	Affective	Psychomotor	
CO1	TPS2	Understand	Respond	Guided Response	1.1,2.3.1,2.3.2
CO2	TPS2	Understand	Respond	Guided Response	1.1,2.3.1,2.3.2
CO3	TPS3	Apply	Value	Mechanism	2.3.1,2.3.2,4.1.1,4.1.2,4.1.6,
CO4	TPS3	Apply	Value	Mechanism	2.3.1,2.3.2,4.1.1,4.1.2,4.1.6,
CO5	TPS3	Apply	Value	Mechanism	2.3.1,2.3.2,4.1.1,4.1.2,4.1.6,
CO6	TPS3	Apply	Value	Mechanism	2.3.1,2.3.2,4.1.1,4.1.2,4.1.6,

Mapping with Programme Outcomes and Programme Specific Outcomes

COs	PO1	PO2	PO3	PO4	PO5	PO6	PO7	PO8	PO9	PO10	PO11	PO12	PSO1	PSO2
CO1	M	L	-	-	-	L	S	M	M	L	L	L	L	M
CO2	M	L	-	-	-	L	S	M	M	L	L	L	L	M
CO3	S	M	L	-	-	L	S	M	M	L	L	L	L	M
CO4	S	M	L	-	-	L	S	M	M	L	L	L	L	M
CO5	S	M	L	-	-	L	S	M	M	L	L	L	L	M
CO6	S	M	L	-	-	L	S	M	M	L	L	L	L	M

S- Strong; M-Medium; L-Low

Assessment Pattern: Cognitive Domain

Cognitive Levels	Continuous Assessment Tests			Assignment			Terminal Examination
	1	2	3	1	2	3	
Remember	20	20	20	-	-	-	20
Understand	40	40	40	-	-	-	40
Apply	40	40	40	10	10	10	40
Analyse	-	-	-	-	-	-	-
Evaluate	-	-	-	-	-	-	-
Create	-	-	-	-	-	-	-

Assessment Pattern: Psychomotor

Psychomotor Skill	Mini project/Assignment/Practical Component
Perception	-
Set	-
Guided Response	50
Mechanism	50
Complex Overt Responses	-
Adaptation	-
Origination	-

Sample Questions for Course Outcome**Course Outcome 1 (CO1):**

1. Describe the Principles of Sustainable Development.
2. List the Millennium Development Goals.

Course Outcome 2 (CO2):

1. Discuss the economic dimensions of Urban sustainability.
2. Explain the Ecological Foot Print.

Course Outcome 3 (CO3):

1. Discuss the various theories of Urban Ecology.
2. Describe concept of Ecocity

Course Outcome 4 (CO4):

1. Apply the concept of IWRM to your city and comment on the outcome.
2. Solve the Interstate water disputes using IWRM concept.

Course Outcome 5 (CO5):

1. Sequence the status of wastewater generation, collection, treatment and disposal in the country.
2. Describe the impacts of improper disposal sewage on eco system

Course Outcome 6 (CO6):

1. Produce the results of Future Proofing Cities done for Madurai city and comment on it.
2. How to adapt the climate change impacts in Cities?

Concept Map

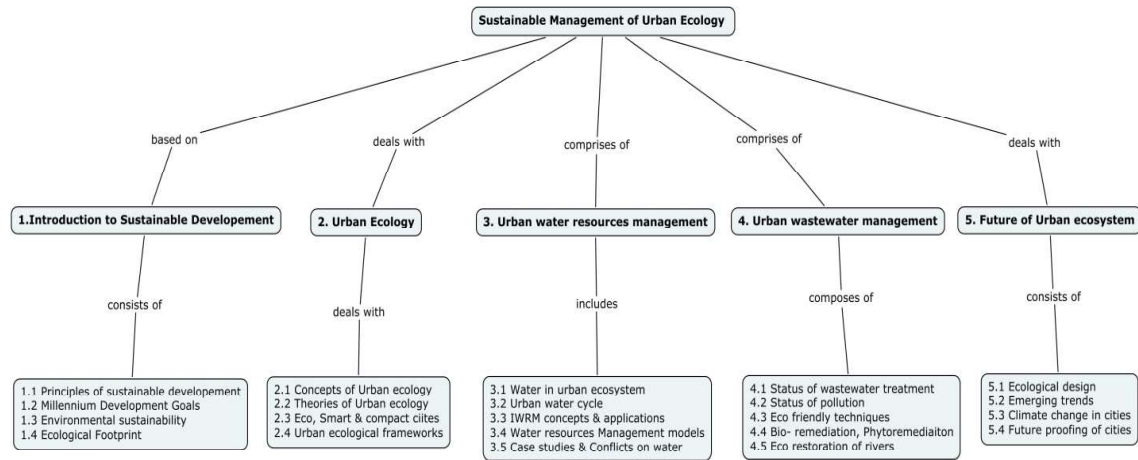

Syllabus

Introduction to Sustainable Development: Definitions and principles of Sustainable Development –Environment and Development linkages –Millennium Development Goals
Environmental Sustainability: Planning, Measuring Sustainability - Carrying Capacity and its limits - Social Capital and its limits- Urban sustainability, Social, Economic , Ecological dimensions, Concept of Ecological Foot print
Urban Ecosystem Concepts and theories of urban ecology- Linkages with sustainable urbanism – Concepts of Eco cities, smart cities, compact cities- Urban Ecosystem Challenges and opportunities – Urban areas and ecological services, Urban Ecological Frameworks
Urban water resources management: Water in urban ecosystem – Urban Water Cycle - storm water management practices – Water harvesting Structures – IWRM concepts and applications to Urban Water management - Integrated urban water planning– Water Resources management models and Water policy of Developed nations- National water Policy -Conflicts on water between Interstate and country –water Pricing – Case studies
Urban wastewater management: Status of Wastewater treatment and disposal, pollution in India – Impacts on ecosystem, Eco friendly treatment systems- concept of decentralization – Bio remediation, Phytoremediation- Wastewater management policy and models of Developed nations– eco restoration of rivers – Case studies.
Futures of Urban Ecosystems Scenario Planning and Adaptive Management, Ecological Design, Emerging Trends and Technologies, Integrated Models, Climate modifications and managing climate change challenges in cities, Adaptation and mitigation measures to make cities resilient Future proofing of cities.

Learning Resources

1. Neil S. Grigg., “Urban Water Infrastructure Planning – Management and Operations”, John Wiley and Sons, 1986.
2. Philip James, Jari Niemelä, Jürgen H. Breuste “Urban Ecology: Patterns, Processes and Applications”, OUP Oxford, 2011.
3. Tracer Strange and Anne Baley , “Sustainable Development –Linking economy, Society , environment” , StatLink from OECD Publishing 2008.
4. UNU/IAS Report , “Defining an Ecosystem Approach to Urban Management and Policy Development” March 2003 .
5. Zhifeng Yang “Eco- Cities: A Planning Guide (Applied Ecology and Environmental Management)” CRC Press, 2012.

Course Contents and Lecture Schedule

Module No.	Topic	No. of Hours	Course Outcome
1.0	Introduction to Sustainable Development		
1.1	Definitions and principles of Sustainable Development - History and emergence of the concept of Sustainable Development	1	CO1
1.2	Environment and Development linkages -	1	CO1

	Globalization and environment- Millennium Development Goals: Status (global and Indian)		
1.3	Environmental Sustainability Planning Measuring Sustainability - Carrying Capacity And its Limits	1	CO1
1.4	Social Capital And its Limits	1	CO1
2.0	Introduction to urban sustainability		
2.1	Social dimensions, Economic dimensions, Ecological dimensions	2	CO2
2.2	Physical aspects	1	CO2
2.3	Concept of Ecological Foot print.	1	CO2
3.0	Urban ecology		
3.1	Concepts and theories of urban ecology and linkages with sustainable urbanism	1	CO3
3.2	Concepts of Eco cities, smart cities, compact cities etc.	1	CO3
3.3	Urban Ecosystem Challenges and opportunities of urban, rural and Periurban growth,	1	CO3
3.4	Processes in human population growth, urbanization and implications for urban ecology	1	CO3
3.5	Urban areas and ecological ecosystem services	1	CO3
3.6	Urban Ecological Frameworks, the principles and frameworks of ecology	1	CO3
3.7	Environmental perspectives on Urban master plans	1	CO3
3.8	Institutions working on Water, Environment- National/International levels	1	CO3
4.0	Urban water resources management		
4.1	Water in urban ecosystem	1	CO4
4.2	Urban Water Cycle	1	CO4
4.3	Urban water resources planning and organization aspects	1	CO4
4.4	Rainfall- runoff- Groundwater Recharge in urban regions	1	CO4
4.5	Storm water management practices storage capacity of urban components	1	CO4
4.6	Water harvesting Structures	1	CO4
4.7	IWRM – concepts and applications to Urban Water management and Distribution	1	CO4
4.8	Integrated urban water planning	1	CO4
4.9	Water Resources management models and Water policy of Developed nations	1	CO4
4.10	Case studies -Conflicts on water- Interstate/ country – water Pricing	1	CO4
5.0	Urban wastewater management		
5.1	Status of Wastewater treatment and disposal on India/ developed nations	1	CO5
5.2	Status of pollution	1	CO5
5.3	Eco friendly treatment systems-concept of decentralization	1	CO5
5.4	Bio remediation, Phytoremediation	1	CO5
5.5	Wastewater management policy and models of Developed nations-Case studies	1	CO5
5.6	Case study on restoration of rivers	1	CO5
6.0	Futures of Urban Ecosystems		

6.1	Scenario Planning and Adaptive Management	1	CO6
6.2	Ecological Design, Emerging Trends and Technologies	1	CO6
6.3	Integrated Models, Climate modifications and managing climate change challenges in cities,	1	CO6
6.4	Adaptation and mitigation measures to make cities resilient Future proofing of cities	1	CO6
Total		36	

Course Designers:

1. Dr. S. Chandran schandran@tce.edu
2. Dr. V. RaviSankar environmentengr@tce.edu

18CERHO	CONSTRUCTION EQUIPMENT MANAGEMENT				
	Category	L	T	P	Credit
	PE	2	1	0	3

Preamble

Selection of appropriate equipment based on the requirements of project is crucial for completion of project at optimal cost and time. The mistakes during selection of equipment for any construction can be avoided by scheduling and optimising the construction equipment system productivity and making proper equipment financing decisions. This can be accomplished by understanding cost and life of equipment and its maintenance

Prerequisite

Nil

Course Outcomes

On the successful completion of the course students will be able to

CO Number	Course Outcome Statement	Weightage*** in %
CO1	Select an appropriate equipment for a specific purpose	15
CO2	Estimate various cost components of equipment for different specifications	15
CO3	Adapt suitable financing methods by considering equipment replacement strategies	15
CO4	Select the optimum productive equipment among available specifications	15
CO5	Apply the concept of scheduling for horizontal and vertical construction projects	15
CO6	Explain the methodology of equipment maintenance program	10

*** Weightage depends on Bloom's Level, number of contact hours,

CO Mapping with CDIO Curriculum Framework

CO #	TCE Proficiency Scale	Learning Domain Level			CDIO Curricular Components (X.Y.Z)
		Cognitive	Affective	Psychomotor	
CO1	TPS3	Apply	Value	Mechanism	1.2,2.3.1,2.3.3,2.5.4,3.1.2,3.2.3,3.2.4,4.1.2,4.3.1,4.3.4,4.6.5
CO2	TPS3	Apply	Value	Mechanism	1.1.1,2.1.1,2.1.3,2.5.1,3.1.5,3.2.3,4.2.2,4.4.3,4.6.6
CO3	TPS3	Apply	Value	Mechanism	1.2,2.1.3,2.1.5,2.3.1,2.3.3,2.3.4,2.4.1,2.4.7,2.5.1,2.5.4,3.1.4,3.1.5,3.2.3,3.2.4,4.1.2,4.2.1,4.2.2,4.2.4,4.3.1,4.3.4,4.6.1,4.6.3,4.6.5,4.6.6
CO4	TPS3	Apply	Value	Mechanism	1.1.1,1.2,2.1.1,2.1.3,2.1.5,2.2.4,2.3.3,2.3.4,2.4.2,2.4.6,2.5.1,2.5.4,3.1.5,3.2.3,3.2.5,3.2.6,4.1.1,4.1.2,4.2.1,4.2.2,4.2.4,4.3.1,4.3.4,4.6.6
CO5	TPS3	Apply	Value	Mechanism	1.1.1,1.2,2.1.1,2.1.3,2.1.5,2.2.4,2.3.3,2.3.4,2.4.2,2.4.6,2.5.1,2.5.4,3.1.5,3.2.3,3.2.5,3.2.6,4.1.1,4.1.2,4.2.1,4.2.2,4.2.4,4.3.1,4.3.4,4.6.6
CO6	TPS2	Understa	Respond	Guided	1.2,2.1.1,2.1.5,2.3.1,2.3.4,2.4.5,2.4.6,

		nd		Response	2.4.7,2.5.1,2.5.4,3.1.1,3.1.2,3.1.4,3.1.5, 3.2.1,3.2.3,3.2.4,3.2.6,4.1.1,4.4.2.1, 4.2.2,4.2.4,4.3.1, 4.3.3,4.3.4,4.4.1,4.5.1,4.5.6 4.6.1,4.6.3,4.6.5,4.6.6
--	--	----	--	----------	--

Mapping with Programme Outcomes and Programme Specific Outcomes

Cos	PO1	PO2	PO3	PO4	PO5	PO6	PO7	PO8	PO9	PO10	PO11	PO12	PSO1	PSO2
CO 1	S	M	L	-	-	-	-	S	S	S	S	M	M	M
CO 2	S	M	L	-	-	-	-	S	L	S	M	M	M	L
CO 3	S	M	L	-	-	L	-	S	S	S	S	L	M	M
CO 4	S	M	L	-	-	L	-	M	-	M	S	L	M	L
CO 5	S	M	L	-	-	M	L	S	S	S	M	M	M	M
CO 6	M	L	-	-	-	M	M	M	M	S	S	L	L	M

S- Strong; M-Medium; L-Low

Assessment Pattern: Cognitive Domain

Bloom's Category	Continuous Assessment Tests			Assignment			Terminal Examination
	1	2	3	1	2	3	
Remember	20	20	20	-	-	-	20
Understand	20	20	40	-	-	-	20
Apply	60	60	40	10	10	10	60
Analyse	0	0	0	-	-	-	0
Evaluate	0	0	0	-	-	-	0
Create	0	0	0	-	-	-	0

Assessment Pattern: Psychomotor

Psychomotor Skill	Miniproject /Assignment/Practical Component
Perception	-
Set	-
Guided Response	20
Mechanism	80
Complex Overt Responses	-
Adaptation	-
Origination	-

Sample Questions for Course Outcome Assessment**

Course Outcome 1(CO1):

1. Identify the role of heavy equipment in construction.
2. Explain in detail about Excavating equipment with their classification and also the selection criteria.
3. Discuss the various activities for which a dozer can be used.

Course Outcome 2(CO2):

1. List the constituents of ownership cost.

2. Compare the depreciation in each year of the equipment's useful life for each of the above depreciation methods for the following wheeled front-end bucket loader:
 - Initial cost: Rs.148,000 includes delivery and other costs
 - Tire cost: Rs.16,000
 - Useful life: 7 years
 - Salvage value: Rs.18,000
3. Estimate hourly repair cost of the scraper in Example 2.3 for the second year of operation. The initial cost of the scraper is Rs. 1,86,000, tire cost Rs.14,000, and its useful life is 5 years. Assume average operating condition and 2000 h of operation per year.

Course Outcome 3(CO3):

1. Prepare a list of factors making lease an attractive option for financing.
2. Apply the equipment life stages and replacement decision making process in equipment intensive project for improving productivity.
3. Summarize "Renting" method of acquiring equipment for a project work.

Course Outcome 4 (CO4):

1. An 18–cubic yard dump truck has a loading time of 3 min, a travel time of 7 min, and the dumping and delay times of 5 min. Calculate the cycle time, optimum number of hauling units, and productivity.
2. List the assumptions in Peurifoy's method.
3. A Project related to a Pile Construction, the site engineer having 3 options of Backhoe equipment specification (B1, B2, and B3) to carry out this project. Analyze the different specification and select an optimum specification from project's productivity perspective.

Course Outcome 5 (CO5):

1. Discuss the equipments for Vertical construction.
2. A Construction project involves prefabrication concept has been taken by your organization. For execution of this project needs various lifting equipments in the site. The Project team wants to know about the Lifting process, Strategies, Constraints and its productivity. As equipment manager how will you explain the methodology of this situation for effective execution of work in the site?

Course Outcome 6(CO6):

1. Explain the significance of a maintenance program
2. Discuss budgeting system in designing equipment maintenance program
3. Review the methodology of equipment maintenance program for a project.

Concept Map

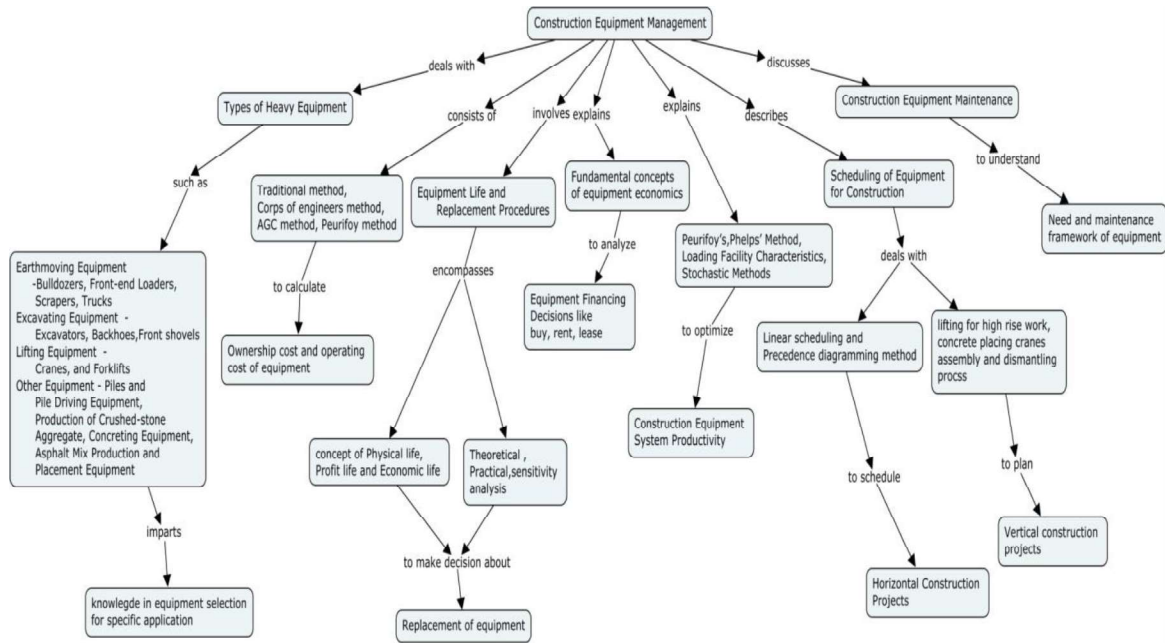

Syllabus

Role of Heavy Equipment in Construction- Bulldozers, Front-end Loaders, Scrapers, Trucks, Excavators, Backhoes, Front shovels, Cranes, and Forklifts; Piles and Pile-Driving Equipment; Production of Crushed-stone Aggregate; Concreting Equipment; Asphalt Mix Production and Placement - Asphalt Plants, and Paving Equipment
Cost of Owning and Operating Construction Equipment - Ownership cost, Depreciation, Operating cost, calculation methods;
Equipment Life and Replacement Procedures - Physical, profit and economic life, Replacement analysis and selection,
Equipment Financing Decisions–Fundamental Concepts of Equipment economics - Financing methods, Rental and lease contract considerations;
Optimizing Construction Equipment Productivity - Peurifoy’s method of optimizing productivity, Phelps’ Method, Load growth curve, Stochastic methods for estimation of productivity;
Scheduling Equipment Intensive Projects - Horizontal Construction-Linear scheduling method, Precedence diagramming method, Vertical Construction-lifting for high rise work, Erection-dismantling, concrete placing cranes;
Construction Equipment Maintenance-Need and Designing a Maintenance Program

Learning Resources

1. Gransberg, D.G., Popescu, C. M., and Ryan, R. C., “Construction equipment management for engineers, estimators, and owners”, Taylor & Francis, New York, 2006.
2. Peurifoy, R. L., Schexnayder, C. J., Shapira, A., and Schmitt, R., “Construction planning, equipment, and methods”, 8th ed., McGraw Hill, New York, 2010.
3. Sharma S.C., “Construction equipment and management, Khanna Publishers, New Delhi, 2011.
4. Day, D. A. and Benjamin, N. B. H., “Construction equipment guide”, 2nd edition, Wiley Publications, New Jersey, 1991.
5. Equipment economics-<https://nptel.ac.in/courses/105103023/>
6. <https://www.constructionequipment.com/>
7. <https://www.nbmcw.com/>

Course Contents and Lecture Schedule

Module No.	Topic	No. of Hours	Course Outcome
1	Introduction		
1.1	Role of Heavy Equipment in Construction-Earthmoving Equipment Selection - Bulldozers, Front-end Loaders, Scrapers, Trucks	1	CO1

1.2	Excavating Equipment Selection - Excavators, Backhoes, Front shovels	1	
1.3	Lifting Equipment Selection - Cranes, and Forklifts	1	
1.4	Other Equipment - Piles and Pile Driving Equipment, Production of Crushed-stone Aggregate, Concreting Equipment, Asphalt Mix Production and Placement Equipment	1	
2	Ownership and Operating cost of equipment		
2.1	Ownership cost – depreciation cost	1	CO2
	Tutorials	2	
2.2	Cost of operating construction equipment	1	
	Tutorials	2	
2.3	Other methods-Corps of engineers, AGC, Peurifoy	1	
3	Equipment Life and Replacement Procedures		
3.1	Equipment life – Physical life, Profit life and Economic life	1	CO3
3.2	Replacement Analysis - Theoretical methods, Practical methods, and sensitivity analysis	1	
3.3	Replacement equipment selection	1	
4	Equipment Financing Decisions		
4.1	Fundamental concepts of equipment economics	1	
4.2	Financing Methods-Buy, rent and lease	1	
	Tutorials	2	
5	Optimizing Construction Equipment Productivity		
5.1	Peurifoy's & Phelps' Method	1	CO4
	Tutorials	2	
5.2	Load growth curve	1	
	Tutorials	2	
5.3	Stochastic Methods	1	
6	Scheduling Equipment Intensive projects		
6.1	Horizontal Construction Projects- Linear scheduling method, Precedence diagramming method	3	CO5
	Tutorials	2	
6.2	Vertical Construction Projects- lifting for high rise work, Erection-dismantling, concrete placing cranes	2	
7	Construction Equipment Maintenance		
7.1	Need for a maintenance program	2	CO6
7.2	Designing a Maintenance Program	2	
	Total Hours		36

Course Designers:

- | | |
|-------------------------|-------------------------|
| 1. Dr. G.Chitra | gcciv@tce.edu |
| 2. Ms.T.Karthigai priya | karthigai priya@tce.edu |

18CERJ0	MANAGEMENT OF HUMAN RESOURCES, SAFETY AND QUALITY				
	Category	L	T	P	Credit
	PE	3	0	0	3

Preamble

This course will create awareness on the management of human resources, safety and quality for an organization; Impart knowledge on the functions, importance and various codes and standards available for managing human resources, safety and quality.

Prerequisite

Nil

Course Outcomes

On the successful completion of the course, students will be able to

CO Number	Course Outcome Statement	Weight age in %
CO1	Explain the functions, process and importance of Human resource Management in the Construction Industry	15
CO2	Relate the grievances faced in a construction industry with the various codes and laws available in the human resource management and suggest suitable measures to solve them	20
CO3	Interpret responsibilities of parties in organizations and apply appropriate practices to ensure safety in organizations	15
CO4	Solve the safety related crisis in construction using the Ergonomics and OSHA Codes and Standards	10
CO5	Explain the Elements, Characteristics, and the importance of ISO 9000 codes and standards of Quality in Construction Industry	15
CO6	Compute the Quality of a product using statistical methods of quality control sampling technique	25

CO Mapping with CDIO Curriculum Framework

CO #	TCE Proficiency Scale	Learning Domain Level			CDIO Curricular Components (X.Y.Z)
		Cognitive	Affective	Psychomotor	
CO1	TPS2	Understand	Respond	Guided Response	2.3.1, 2.4.1, 2.4.2, 2.4.5, 2.4.6, 2.4.7, 2.5.1, 2.5.2, 2.5.3, 2.5.4, 3.1.1, 3.1.2, 3.1.3, 3.1.4, 3.1.5, 3.2.1, 3.2.2, 3.2.3, 3.2.4, 3.2.5, 3.2.6, 4.3.1, 4.3.2, 4.3.3, 4.3.4
CO2	TPS3	Apply	Value	Mechanism	2.3.1, 2.4.1, 2.4.5, 2.4.6
CO3	TPS2	Apply	Value	Mechanism	2.3.1, 2.4.1, 2.4.2, 3.2.2, 3.2.3,
CO4	TPS3	Apply	Value	Mechanism	1.1.2, 2.3.1, 2.4.1, 2.4.2
CO5	TPS2	Understand	Respond	Guided Response	2.3.1, 2.4.1
CO6	TSP3	Apply	Value	Mechanism	1.1.1, 1.2, 2.1.1, 2.1.3, 2.4.1

Mapping with Programme Outcomes

COs	PO1	PO2	PO3	PO4	PO5	PO6	PO7	PO8	PO9	PO10	PO11	PO12	PSO1	PSO2
CO1	M	L	--	--	--	L	L	L	L	L	L	L	L	L
CO2	S	M	L	L	--	S	M	S	S	S	M	S	L	S

CO3	S	M	L	M	--	S	S	S	S	S	M	M	M	S
CO4	S	M	L	M	--	S	M	S	S	S	M	S	M	S
CO5	M	L	--	L	--	L	L	L	L	L	L	L	L	L
CO6	S	M	L	M	--	S	S	S	S	S	M	S	M	S

S- Strong; M-Medium; L – Low

Assessment Pattern: Cognitive Domain

Cognitive Levels	Continuous Assessment Tests			Assignment			Terminal Examination
	1	2	3	1	2	3	
Remember	20	20	20	-	-	-	20
Understand	30	30	30	60	60	60	30
Apply	50	50	50	40	40	40	50
Analyse	0	0	0	-	-	-	0
Evaluate	0	0	0	-	-	-	0
Create	0	0	0	-	-	-	0

Assessment Pattern: Psychomotor

Psychomotor Skill	Mini-project /Practical Component/Observation
Perception	-
Set	-
Guided Response	70
Mechanism	30
Complex Overt Responses	-
Adaptation	-
Origination	-

Course Level Assessment Questions

Course Outcome 1 (CO1)

1. Describe about manpower planning for Construction Companies.
2. Explain the ideas behind discipline and separation process in Construction Industry.

Course Outcome 2 (CO2)

1. As a HR manager of a firm suggest the new schemes you would implement for your labour to work in harmony
2. Relate the code of ethics and standards as per the norms in document with code of ethics and standards followed in the Organization of current scenario.

Course Outcome 3 (CO3)

1. Summarize the role of various parties involved in Construction Safety Management.
2. An accident has happened to a worker due to struck in-between parts of machinery. As a safety manager for the industry what measures would you suggest to avoid occurrence of such incident in future.

Course Outcome 4 (CO4)

1. Prepare a safety audit report for a construction project highlighting some critical issues
2. Sketch a new tool for evaluating construction safety or an existing tool with a change of few parameters

Course Outcome 5 (CO5)

1. Distinguish between quality by design and quality by conformance
2. Extend the ideas behind quality elements and characteristics with its importance

Course Outcome 6 (CO6)

1. Write the need for implementing Lean Six sigma principles in construction projects
2. Five defects are observed in 467 units produced. Calculate the short term and long term Z_{ST} and Z_{LT} , respectively. Also estimate the ppm value.

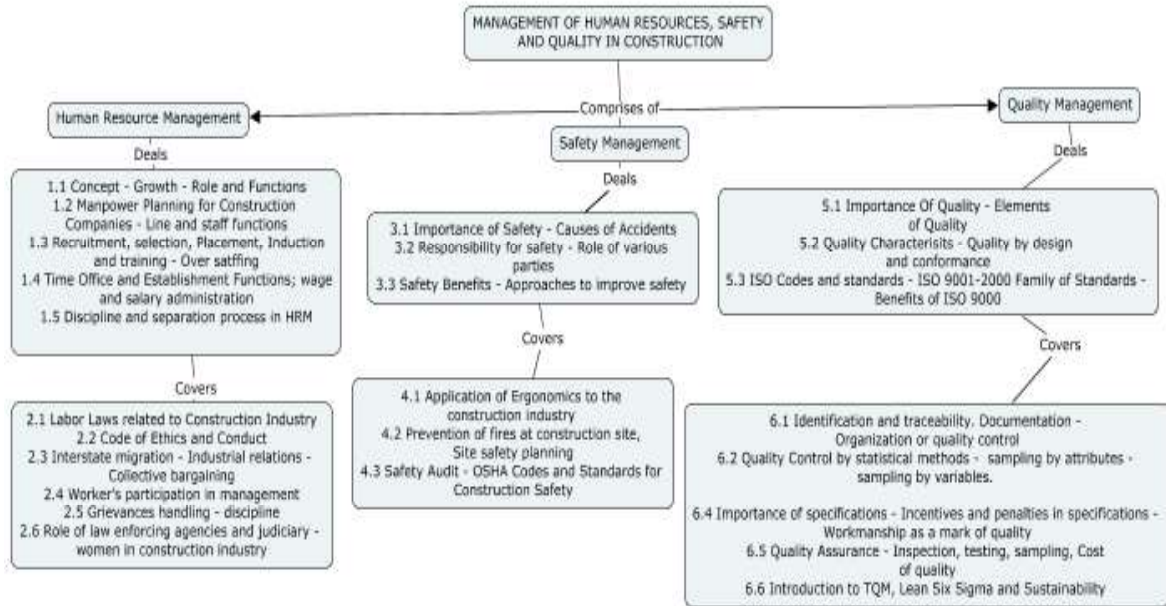
Concept Map**Syllabus**

Human Resources Management - Concept - Growth - Role and functions. Manpower Planning for Construction Companies - Line and Staff functions - Recruitment, selection, placement, induction and training - over staffing; Time office and establishment functions; wage and salary administration - Discipline - Separation Process. **Labor Legislation**- labor laws related to construction industry – Code of Ethics and Conduct - Interstate migration - Industrial relations - Collective bargaining - Worker's participation in management. Grievances handling - discipline - role of law enforcing agencies and judiciary - women in construction industry. **Safety Management** - importance of safety- causes of accidents - responsibility for safety - Role of various parties in safety management - safety benefits - approaches to improve safety in construction for different works. **Safety Implementation** - Application of Ergonomics in the construction industry - prevention of fires at construction site - Safety audit, OSHA Codes and Standards for Construction Safety. **Quality Management in Construction** - Importance of quality - Elements of quality - quality characteristics - quality by design - quality conformance. ISO Codes and standards- ISO 9001-2000 Family of Standards- Benefits of ISO 9000- **Quality Control and Assurance** - identification and traceability for quality control. Documentation - Organization for quality control, Quality Control by statistical methods- Statistical Quality Control with sampling by attributes- Statistical Quality Control with sampling by variables - Importance of specifications- Incentives and penalties in specifications - Workmanship as a mark of quality. Quality assurance techniques - Inspection, testing, sampling, Cost of quality. Introduction to TQM, Lean Six Sigma and Sustainability.

Reference Books

1. Josy J. Farrilaro, "Hand Book of Human Resources Administration" McGraw Hill (International Edition) 1987.
2. Manoria C.B., "Personnel Management", Himalaya Publishing House, 1992.
3. Arya Ashok "Discipline & Disciplinary procedure" Organisation Development Institute, 1998

4. Arya Ashok, "Management case studies – An analytical and Developmental Tool" Organisation Development Institute, New Delhi, 1999
5. Malik, P.L., "Handbook of Labour & Industrial Law", Eastern book company, Lalbagh, Lucknow, 2010
6. Grant E.L., and Leavens worth, "Statistical Quality Control", Mc Graw Hill, 1984.
7. Kumar Neeraj Jha, "Construction Project Management Theory and Practice", Pearson, 2011.
8. Dr.S.Seetharaman, "Construction Engineering and Management Fifth Edition", Umesh Publications, 2018
9. Construction Safety Manual for Works Contract – Bhabha Atomic Research Centre, Mumbai (BARC)
10. NPTEL- Principles of Human Resource Management : <https://nptel.ac.in/courses/110105069/>
11. NPTEL- Principles of Construction management : <https://nptel.ac.in/courses/105104161/>

Course Contents and Lecture Schedule

Module No.	Topic	No. of Lectures	Course Outcome
1.0	Human Resources Management		
1.1	Concept - Growth - Role and functions	1	CO1
1.2	Manpower Planning for Construction Companies - Line and Staff function	1	
1.3	Recruitment, selection, placement, induction and training - over staffing	1	
1.4	Time office and establishment functions; wage and salary administration	1	
1.5	Discipline - Separation Process	1	
2.0	Labor Legislation		
2.1	Labor laws related to construction industry	2	CO2
2.2	Code of Ethics and Conduct	1	
2.3	Interstate migration - Industrial relations - Collective bargaining	1	
2.4	Worker's participation in management	1	
2.5	Grievances handling – discipline	1	
2.6	Role of law enforcing agencies and judiciary - women in construction industry	1	
3.0	Safety Management		
3.1	Importance of safety - causes of accidents	2	CO3
3.2	Responsibility for safety - Role of various parties in safety management.	2	
3.3	Safety benefits. Approaches to improve safety in construction for different works. Safety Measurement	2	
4.0	Safety Implementation		
4.1	Application of Ergonomics to the construction industry	1	CO4
4.2	Prevention of fires at construction site, Site safety planning	1	
4.3	Safety Audit - OSHA Codes and Standards for Construction Safety	2	
5.0	Quality Management in Construction		
5.1	Importance of quality; Elements of quality	1	CO5

5.2	Quality characteristics - Quality by design - quality by conformance	2	
5.3	ISO Codes and standards - ISO 9001-2000 Family of Standards - Benefits of ISO 9000	2	
6.0	Quality Control and Quality Assurance		
6.1	Identification and traceability. Documentation - Organization for quality control	1	CO6
6.2	Quality Control by statistical methods - Statistical Quality Control with sampling by attributes - Statistical Quality Control with sampling by variables.	3	
6.4	Importance of specifications - Incentives and penalties in specifications - Workmanship as a mark of quality	1	
6.5	Quality Assurance - Inspection, testing, sampling, Cost of quality	2	
6.6	Introduction to TQM, Lean Six Sigma and Sustainability	2	
	Total Periods	36	

Course Designers:

- | | | |
|----|-----------------|---------------|
| 1. | Dr. G. Chitra | gcciv@tce.edu |
| 2. | Mr. D. Rajkumar | drciv@tce.edu |
| 3. | Mr. G.S. Jegan | gsjcv@tce.edu |

18CERK0	MATERIAL PROCUREMENT AND MANAGEMENT				
	Category	L	T	P	Credit
	PE	3	0	0	3

Preamble

This course focuses on the core principles of project procurement management, material planning and evaluation methods of materials consumed in various infrastructure domains. Students are exposed to effective techniques for successfully allocating risks and delivering projects which help in acquiring future projects.

Prerequisite

Nil

Course Outcomes

On the successful completion of the course, students will be able to:

CO Number	Course Outcome Statement	Weight age in %
CO1	Explain the scope, functions, and importance of material procurement management in the construction industry	10
CO2	Classify the materials of construction, compare the different sources of procurement, and conduct vendor analysis	20
CO3	Select and apply inventory control technique needed for the effective management of Inventory in the Construction Industry	15
CO4	Solve the problems on Economic ordering quantity considering orderpoint control, safety stock, stock outs and discounts	15
CO5	Apply site layout procedure and site organizational methods for the management of stores in the Construction Industry	10
CO6	Apply statistical methods of sampling technique to compute the quality of material	10
CO7	Apply material management systems in planning, procurement, inventory and cost control of materials in the Construction Industry	20

CO Mapping with CDIO Curriculum Framework

CO #	TCE Proficiency Scale	Learning Domain Level			CDIO Curricular Components(X.Y.Z)
		Cognitive	Affective	Psychomotor	
CO1	TPS2	Understand	Respond	Guided Response	2.3.1, 2.3.2, 2.3.3, 2.4.7, 2.5.1, 3.1.1, 3.1.2, 4.1.1, 4.3.4
CO2	TPS4	Analyze	Organize	Complex/Overt Responses	1.1.1, 2.1.3, 2.1.5, 2.4.4, 2.4.7, 4.2.2
CO3	TPS2	Apply	Value	Mechanism	1.1.1, 2.3.1, 2.3.3, 2.4.7
CO4	TPS3	Apply	Value	Mechanism	1.1.1, 2.1.1, 2.1.3, 2.1.5, 2.4.7
CO5	TPS2	Apply	Value	Mechanism	2.3.1, 2.3.2, 2.3.3, 2.4.7, 3.1.1, 3.1.2
CO6	TSP3	Apply	Value	Mechanism	1.1.1, 2.1.1, 2.1.3, 2.1.5, 2.4.7
CO7	TSP3	Apply	Value	Mechanism	1.1.1, 2.1.1, 2.3.1, 2.4.7,

4.3.4

Mapping with Programme Outcomes

COs	PO1	PO2	PO3	PO4	PO5	PO6	PO7	PO8	PO9	PO10	PO11	PO12	PSO1	PSO2
CO1	M	L	--	--	--	L	--	L	L	M	M	M	L	L
CO2	S	S	M	L	--	M	M	S	S	M	L	M	M	M
CO3	S	M	L	--	--	M	M	S	S	M	M	M	M	M
CO4	S	M	L	--	--	M	M	S	S	M	M	M	M	M
CO5	M	L	--	--	--	M	M	M	M	M	M	M	L	M
CO6	S	M	L	--	--	S	M	S	S	M	M	M	M	S
CO7	S	M	L	--	--	M	L	M	M	S	M	M	M	M

S- Strong; M-Medium; L – Low

Assessment Pattern: Cognitive Domain

Bloom's Category	Continuous Assessment Tests			Assignment			Terminal Examination
	1	2	3	1	2	3	
Remember	10	10	10	-	-	-	10
Understand	20	20	20	40	40	40	10
Apply	50	50	50	60	60	60	50
Analyse	20	20	20	-	-	-	20
Evaluate	0	0	0	-	-	-	0
Create	0	0	0	-	-	-	0

Assessment Pattern: Psychomotor

Psychomotor Skill	Mini-project /Practical Component/Observation
Perception	-
Set	-
Guided Response	40
Mechanism	40
Complex Overt Responses	20
Adaptation	-
Origination	-

Course Level Assessment Questions**Course Outcome 1 (CO1)**

- Describe the role of material managers in Construction Companies.
- Explain the ideas behind Integrated Approach to Materials Management.

Course Outcome 2 (CO2)

- Conduct an ABC analysis for the items shown in the table. Suggest suitable storage locations for A, B and C Category of items in a warehouse. Also construct the ABC analysis chart

Item Code	Cost/ Unit (Rs)	Annual Usage (Units)
K1	25	10000
K2	8	18000
K3	18	14000
K4	70	200000

K5	12	9000
K6	10	40000
K7	10	122000
K8	15	80000
K9	4	10000
K10	18	80000
K11	7	5620
K12	2	8020
K13	7	9900
K14	13	75000
K15	12	5875
K16	5	7500
K17	32	8000
K18	70	800
K19	15	2450
K20	6	1250

2. As a material manager of a firm, discuss the procedure you would adopt for identification of selection of appropriate vendor for purchase of inventory. Give suitable justification

Course Outcome 3 (CO3)

1. List few inventory control policies you would suggest in your organization to satisfy Customers. Also demonstrate the implementation of one inventory policy for achieving maximum satisfaction of customers.
2. Mention the importance of selective inventory control in industry

Course Outcome 4 (CO4)

1. A brick supplier has to supply 25, 00,000 bricks to his client per year. Shortages of about 5 % are allowed. The set-up cost per run is Rs 2250. Determine the following:
 - i) The economic ordering quantity
 - ii) the optimum number of orders per year
 - iii) Maximum number of shortages
 - iv) The optimum period of supply per optimum order
 - v) The increase in total cost associated with ordering
2. As an inventory manager, discuss the techniques you would adopt in your industry to control inventory so as to achieve economy. Give suitable reasons

Course Outcome 5 (CO5)

1. Discuss about the inspection procedures followed in the construction stores.
2. Extend the ideas behind site layout and site organizational method in store management

Course Outcome 6 (CO6)

1. Five defects are observed in 467 units produced. Calculate the short term and long term Z_{ST} and Z_{LT} , respectively. Also estimate the ppm value.
2. Identify and discuss the measures you would adopt to maintain quality in material management in your industry

Course Outcome 7 (CO7)

1. As a material manager for a construction project, what do you think are the micro and macro factors? You should consider while planning for the materials in project. Discuss giving the reasons
2. As an infrastructure engineer suggest suitable measures of identification and management of risks in relation to material management taking a project of your choice

Concept Map

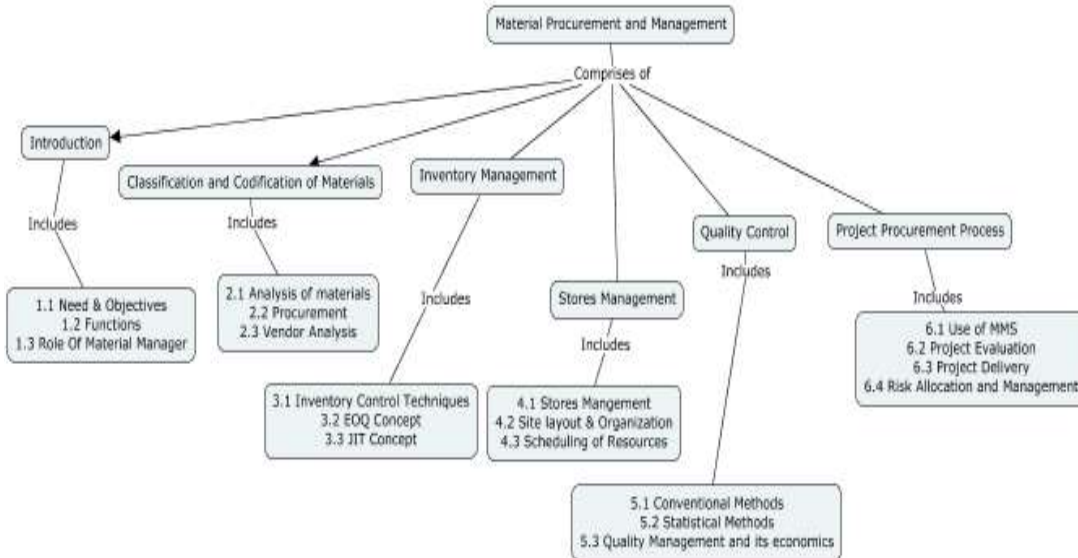

Syllabus

Introduction: Importance of material management and its role in construction industry, scope, objectives and functions - Integrated approach to material management - Role of materials manager. **Classification and Codification of materials of construction:** ABC, FSN, VED, SOS analysis - Procedure and its use, Standardization in materials and their management, Procurement - Identification of sources of procurement, vendor analysis. Materials Requirement Planning (MRP), Purchase procedure, legal aspects. **Inventory Management:** Store Purchase Manual - Contractors Obligation - Inventory Control techniques - EOQ, Advantages and limitation of use of EOQ, Periodic ordering, order point control, safety stock, stock outs, Application of ABC analysis in inventory control, Just in Time (JIT) Management, Indices used for assessment of effectiveness of inventory management. **Stores Management:** Receipt and inspection, care and safety in handling, loss on storage, wastage, Bulk purchasing, site layout and site organization, scheduling of men, materials and equipment. **Quality Control** – Conventional methods of quality control of Construction materials. Statistical methods of quality control, sampling techniques in quality control process - Quality management and economics. **Project procurement processes.** Materials Management Systems (MMS) and its scope in materials planning, procurement, inventory control, cost control etc. **Project evaluation:** Discounted Cash Flow, Real Options Theory - Project delivery methods, Competitive bidding- Risk allocation and management - Integrated project delivery - Contract negotiation.

References

1. Chitale A.K. and R.C. Gupta, "Material Management – Text and Cases", Prentice Hall of India Pvt. Ltd., 2007
2. Denise Bower, "Management of Procurement", Construction Management Series, Thomas Telford Publishing, 2003
3. Jhamb L.C., "Inventory Management", Everest Publishing house, 2005

4. Peter Holm Andreasen, "Dynamics of Procurement Management – A Complexity Approach", Copenhagen Business School, 2012
5. Peter Baily, David Farmer, Barry Crocker, David Jessop & David Jones, "Procurement Principles and Management", FT Prentice Hall, 2010
6. R.Paneerselvam, "Production and Operations Management", Publisher prentice hall of India, 2012
7. NPTEL- Operations and Supply Chain Management:
<https://www.youtube.com/watch?v=9tJv5COGkD0>

Course Contents and Lecture Schedule

Module No.	Topic	No. of Lectures
1.0	Introduction to Material Procurement and Management	
1.1	Need and Importance of material management and its role in construction industry	1
1.2	Scope, objectives and functions of material management, Integrated approach to materials management	2
1.3	Role of materials manager	
2.0	Classification and Codification of Materials of Construction	
2.1	ABC, FSN - Procedure and its use	2
	VED, SOS analysis - Procedure and its use	2
2.2	Standardization in materials and their management, Procurement, Identification of sources of procurement	2
2.3	Vendor analysis concept of (MRKP) Material requirement planning, planning, purchase procedure, legal aspects	2
3.0	Inventory Management	
3.1	Inventory Control techniques – principle and applications	3
3.2	EOQ, Advantages and limitation of use of EOQ, Periodic ordering, order point control,	3
	Safety stock, stock outs, application of ABC analysis in inventory control	3
3.3	Concept of Just in time management(JIT), Indices used for assessment of effectiveness of inventory management	1
4.0	Stores Management	
4.1	Receipt and inspection, care and safety in handling, loss on storage, wastage, Bulk purchasing,	2
4.2	Site layout and site organization, scheduling of men, materials and equipment.	2
5.0	Quality Control	
5.1	Quality Control – Conventional methods of quality control of Construction materials. Statistical method of quality control	2
	Sampling techniques quality control in process. Quality management and its economics	2
6.0	Project procurement	
6.1	Project procurement processes: Use of (MMS) – Materials Management Systems in materials planning,	1
	Procurement, inventory control, cost control	1
6.2	Project evaluation: Discounted Cash Flow, Real Options Theory. Project delivery methods, Project delivery methods. Competitive bidding	2
6.3	Project Delivery: Integrated Project Delivery	1
6.4	Risk Allocation and Management, Contract Negotiation	1

	Public Private Partnerships	1
Total Hours		36

Course Designers:

1. Dr. G. Chitra gcciv@tce.edu
2. Mr. G.S. Jegan gsciv@tce.edu

18CERL0	CONTRACTS AND ARBITRATION				
	Category	L	T	P	Credit
	PE	3	0	0	3

Preamble

This course will create awareness on contracts for construction Industry; Impart knowledge on tender preparation, tendering process, Labour regulations, laws on arbitration, arbitration procedure and laws on dispute resolution in India.

Prerequisite

Nil

Course Outcomes

On the successful completion of the course, students will be able to:

CO Number	Course Outcome Statement	Weightage in %
CO1	Explain the types, essentials and various clauses of construction Contracts with their legal aspects and provisions	5
CO2	Prepare the tender and contract document based on the technical, contractual and commercial perspectives of the construction industry	15
CO3	Solve the issues related to tendering and contracting process in the construction industry	20
CO4	Discuss the need and importance of labour regulations in the construction industry	15
CO5	Suggest suitable type of Alternate dispute resolution for the given situational problem in the Construction Industry	25
CO6	Illustrate the rules, proceedings and background of Arbitration in the Construction Industry	20

CO Mapping with CDIO Curriculum Framework

CO #	TCE Proficiency Scale	Learning Domain Level			CDIO Curricular Components (X.Y.Z)
		Cognitive	Affective	Psychomotor	
CO 1	TPS2	Understand	Respond	Guided Response	2.3.1,2.3.2,2.3.3,2.3.4,2.5.1, 2.5.2,3.2.1,3.2.2,3.2.3,3.2.4, 3.2.5,3.2.6,3.3.1,4.1.1,4.1.2,4.1.3,4.1.4,4.1.5
CO 2	TPS3	Apply	Value	Mechanism	2.3.1,2.3.2,2.3.3,2.3.4,2.4.1, 2.4.4,2.5.1,2.5.2,3.2.1,3.2.2, 3.2.3,3.2.4,3.2.5,3.2.6,3.3.1, 4.1.1,4.1.2,4.1.3,4.1.4,4.1.5, 4.3.1, 4.3.4
CO 3	TPS3	Apply	Value	Mechanism	2.3.1, 2.3.2, 2.3.3,2.3.4, 2.4.1,2.4.4,2.5.1, 2.5.2,3.2.1,3.2.2,3.2.3,3.2.4,3.2.5, 3.2.6,3.3.1,4.1.1,4.1.2,4.1.3,4.1.4,4.1.5, 4.3.1, 4.3.4
CO 4	TPS2	Understand	Respond	Guided Response	2.3.1, 2.3.2, 2.3.3, 2.3.4, 2.5.1, 2.5.2, 3.2.1, 3.2.2, 3.2.3, 3.2.4, 3.2.5, 3.2.6, 3.3.1, 4.1.1, 4.1.2, 4.1.3, 4.1.4
CO 5	TPS3	Apply	Value	Mechanism	2.3.1, 2.3.2, 2.3.3, 2.3.4, 2.4.1, 2.4.4, 2.4.7, 2.5.1, 2.5.2, 3.4.2, 3.2.1, 3.2.2, 3.2.3, 3.2.4, 3.2.5, 3.2.6, 3.3.1, 4.1.1, 4.1.2, 4.1.3, 4.1.4, 4.1.5, 4.3.1, 4.3.4

C06	TSP3	Apply	Value	Mechanism	2.3.1, 2.3.2, 2.3.3, 2.3.4, 2.5.1, 2.5.2, 3.4.2, 3.2.1, 3.2.2, 3.2.3, 3.2.4, 3.2.5, 3.2.6, 3.3.1, 4.1.1, 4.1.2, 4.1.3, 4.1.4, 4.1.5, 4.3.1, 4.3.4
-----	------	-------	-------	-----------	---

Mapping with Programme Outcomes

COs	PO1	PO2	PO3	PO4	PO5	PO6	PO7	PO8	PO9	PO10	PO11	PO12	PSO1	PSO2
CO1	M	L	--	--	--	--	--	--	M	L	M	--	L	L
CO2	S	M	L	L	--	M	M	S	S	S	M	M	L	M
CO3	S	M	L	L	--	M	M	S	S	M	M	M	L	M
CO4	M	L	--	--	--	L	L	M	M	L	L	L	L	L
CO5	S	M	L	L	--	M	M	S	S	M	M	M	L	M
CO6	S	M	L	L	--	M	M	S	S	M	M	M	L	M

S- Strong; M-Medium; L – Low

Assessment Pattern: Cognitive Domain

Bloom's Category	Continuous Assessment Tests			Assignment			Terminal Examination
	1	2	3	1	2	3	
Remember	10	10	10	-	-	-	10
Understand	20	20	20	40	40	40	20
Apply	70	70	70	60	60	60	70
Analyse	0	0	0	-	-	-	0
Evaluate	0	0	0	-	-	-	0
Create	0	0	0	-	-	-	0

Assessment Pattern: Psychomotor

Psychomotor Skill	Mini-project /Practical Component/Observation
Perception	-
Set	-
Guided Response	70
Mechanism	30
Complex Overt Responses	-
Adaptation	-
Origination	-

Course Level Assessment Questions

Course Outcome 1 (CO1):

Discuss the important clauses of the contract document.
State the factors which differ in contracts and agreement.

Course Outcome 2 (CO2)

Prepare a sample of tender document showing the things needed in tender notice
The highway department of government is planning to construct a new highway line in a city, as a chief engineer of the department you are vested with the responsibility of preparing tender documents for calling for tenders to invite prospective bidders to take up the work. Identify the items to be included in the tender documents and discuss them.

Course Outcome 3 (CO3)

1. For a proposed nuclear reactor project in India involving huge sum of money suggest a suitable type of contract. Give justifications for your choice.
2. As a contract manager identify the method to select a project based on contract document and issues.

Course Outcome 4 (CO4)

1. Discuss the salient features of laws related to construction industry.
2. Describe the necessity of trade union in Construction Industry.

Course Outcome 5 (CO5)

1. Suggest a specific Alternate Dispute Resolution with the justifications for solving inter-linking of rivers in India.
2. In the republic country, the dispute arose between the state provinces. As a Contract Manager how will you perceive the problem? Suggest Suitable ADR method for Resolving the dispute between the states and explain the procedure to conduct the Same.

Course Outcome 6 (CO6)

- 1 As an arbitrator discuss the procedural difference between a judge and an arbitrator. Who is more powerful in what situation? Discuss
- 2 As a manager, do you think the knowledge on contracts and arbitration is essential? Justify with suitable reasons taking a project of your own choice.

Concept Map

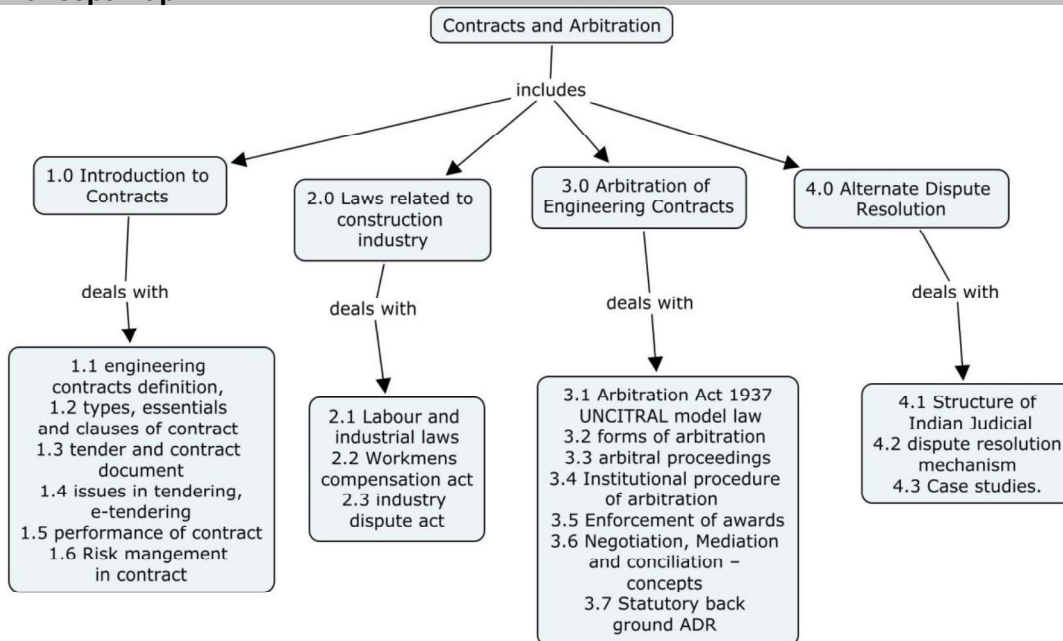

Syllabus

Introduction to contracts in construction industry: Brief details of Engineering contracts – definition, types and essentials of contracts and clauses for contracts – Preparation of tender and contract documents – prequalification, bidding, accepting, evaluation of tender form – technical, contractual and commercial point of view and standard contract documents – International contract document, World bank procedures and guidelines, Law of Torts – Issues related to tendering process- Awarding contract, e-tendering process - Time of performance – provisions of contract law – Breach of contract. Performance of Contracts – Discharge of a contract- Indian Contract Act 1872 – Risk management in contracts. **Laws related to Construction Industry** – Labour and industrial laws - payment of wages act, contract labour – Workmen’s compensation act – Insurance and safety regulations, Industrial dispute act, Indian factory act, Child labour act and other labour laws. **Alternate Dispute resolution** – Litigation in Indian courts, Dispute resolution mechanism under the Indian judicial System. **Arbitration,**

Negotiation, Mediation and Conciliation – concepts and purpose, Statutory back ground ADR and mediation rules, duties of mediator and disclose facts, power of court in mediation, Case studies, Duties of conciliator and negotiator. **Arbitration of Engineering Contracts** – Background of Arbitration in India, The Arbitration and conciliation Act 1996, UNCITRAL model law, Forms of arbitration – arbitration agreement, subject matter and violations, Commencement of arbitral proceedings, constitution of arbitral tribunal, appointment of arbitrator and rules of evidence, Institutional procedure of arbitration, Independence of arbitrators jurisdiction of arbitral tribunal, Interim measures, Enforcement of awards and cost.

References

1. American Arbitration Association, “Construction industry arbitration rules and mediation procedures”, 2007
2. Collex.K, “Managing Construction Contracts”, Reston publishing company, Virginia, 1982
3. Gajaria. G.T, “Laws relating to building and Engineer’s Contracts”, M.M. Tripathi Pvt Ltd., Mumbai, 1985
4. Park.W.B., “Construction Bidding for Projects”, John Wiley, Norway, 1978
5. Vasavada.B.J. “Engineering Contracts and Arbitration”, March 1996
6. The Arbitration and Conciliation (Amendment) Act, 2015

Course Contents and Lecture Schedule

Module No.	Topic	No. of Lectures	Course Outcome
1.0	Introduction to contracts		
1.1	Brief details of Engineering contracts	1	CO1, CO2, CO3
1.2	Types, Essentials of contracts and clauses of contract	1	
1.3	Preparation of tender and documents– prequalification, bidding, accepting, evaluation of tender form – technical, contractual and commercial point of view and standard contract documents.	3	
1.4	International contract document, World bank procedures and guidelines, Law of Torts	2	
1.5	Issues related to tendering process – Awarding contract, e-tendering process	2	
1.6	Time of performance – provisions of contract law – Breach of contract	2	
1.7	Performance of Contracts – Discharge of a contract–Indian Contract Act 1872, Risk management in contracts.	3	
2.0	Laws related to Construction Industry		
2.1	Labour and industrial laws – payment of wages act, contract labour.	2	CO4
2.2	Workmen’s compensation act – Insurance and safety regulations	2	
2.3	Industrial dispute act, Indian factory act, Child labour act and other labour laws	1	
3.0	Alternate Dispute resolution		
3.1	Litigation in Indian courts, Dispute resolution mechanism under the Indian judicial System	2	CO5
3.2	Arbitration, Negotiation, Mediation and Conciliation – concepts and purpose	3	
3.3	Statutory back ground ADR and mediation rules, duties of mediator and disclose facts, power of court in mediation.	2	
3.4	Case studies.	2	
4.0	Arbitration of Engineering Contracts		

Module No.	Topic	No. of Lectures	Course Outcome
4.1	Background of Arbitration in India, The Arbitration and conciliation Act 1996, UNCITRAL model law,	2	CO6
4.2	Forms of arbitration – arbitration agreement, subject matter and violations	1	
4.3	Commencement of arbitral proceedings, constitution of arbitral tribunal, appointment of arbitrator and rules of evidence	2	
4.4	Institutional procedure of arbitration	2	
4.5	Independence of arbitrators jurisdiction of arbitral tribunal, Interim measures, Enforcement of awards and cost.	1	
TOTAL HOURS		36	

Course Designers:

- | | |
|-----------------|---------------|
| 1. Dr.G.Chitra | gcciv@tce.edu |
| 2. Mr.G.S.Jegan | gsjcv@tce.edu |

18CERM0	DESIGN OF REINFORCED CONCRETE STRUCTURES				
	Category	L	T	P	Credit
	PE	3	0	0	3

Preamble

Design of reinforced concrete structures started in the beginning of last century following purely empirical approach. Thereafter came the so-called rigorous elastic theory where the levels of stresses in concrete and steel are limited so that stress-deformations are taken to be linear. However, the limit state method, though semi-empirical approach, has been found to be the best for the design of reinforced concrete structures. This course offers analysis and design of reinforced concrete structures. The course will focus on explaining the background of current design specifications for reinforced concrete structures. It aims at determination of safe as well as economical sections and their reinforcement under various types of load combinations. At the end of the course, student has a comprehensive design knowledge related to structures and systems that are likely to be encountered in professional practice

Prerequisite

18CE610 Design of Reinforced Concrete Elements

Course Outcomes

On the successful completion of the course students will be able to

CO Number	Course Outcome Statement	Weightage*** in %
CO1	Analyse and design the slabs based on Yield line theory and other flat and grid floor slab systems and detail the reinforcement	20
CO2	Analyse and design the building frames by approximate methods and detail the reinforcement	15
CO3	Design the foundation and detail the reinforcement	15
CO4	Design the staircases and detail the reinforcement	10
CO5	Design the retaining walls and detail the reinforcement	15
CO6	Design the water tanks and detail the reinforcement	25

*** Weightage depends on Bloom's Level, number of contact hours

CO Mapping with CDIO Curriculum Framework

CO #	TCE Proficiency Scale	Learning Domain Level			CDIO Curricular Components (X.Y.Z)
		Cognitive	Affective	Psychomotor	
CO1	TPS3	Apply	Value	Mechanism	1.1.1, 2.1.1
CO2	TPS3	Apply	Value	Mechanism	1.1.1, 1.2, 1.3, 2.1.4, 2.1.5, 3.2.3
CO3	TPS3	Apply	Value	Mechanism	1.1.1, 1.2, 1.3, 2.1.5, 2.4.4.

CO4	TPS3	Apply	Value	Mechanism	1.1.1, 1.2,1.3, 2.1.4
CO5	TPS3	Apply	Value	Mechanism	1.1.1, 1.2,1.3, 2.4.4
CO6	TPS3	Apply	Value	Mechanism	1.1.1, 1.2,1.3,2.4.3

Mapping with Programme Outcomes and Programme Specific Outcomes

COs	PO1	PO2	PO3	PO4	PO5	PO6	PO7	PO8	PO9	PO10	PO11	PO12	PSO1	PSO2
CO1	S	M	L	---	---	S	M	S	S	---	S	S	M	M
CO2	S	M	L	---	---	S	M	S	S	---	S	S	M	M
CO3	S	M	L	---	---	S	M	S	S	---	S	S	M	M
CO4	S	M	L	---	---	S	M	S	S	---	S	S	M	M
CO5	S	M	L	---	---	S	M	S	S	---	S	S	M	M
CO6	S	M	L	---	---	S	M	S	S	---	S	S	M	M

S- Strong; M-Medium; L-Low

Assessment Pattern: Cognitive Domain

Cognitive Levels	Continuous Assessment Tests			Assignment			Terminal Examination
	1	2	3	1	2	3	
Remember	10	10	10	-	-	-	10
Understand	10	10	10	-	-	-	10
Apply	80	80	80	100	100	100	80
Analyse							
Evaluate							
Create							

Assessment Pattern: Psychomotor

Psychomotor Skill	Assignment
Perception	-
Set	-
Guided Response	50
Mechanism	50
Complex Overt Responses	-
Adaptation	-
Origination	-

Sample Questions for Course Outcome Assessment**

Course Outcome 1 (CO1):

1. Explain virtual work method.
2. Make use of yield line theory and analyse a one way continuous slab and determine the collapse load by using virtual work method and also equilibrium method.
3. Make of IS codal provisions, design the flat slab for an office building having the interior panel of size 6.5m x 6.5m. The size of the column is 300mm diameter. Super imposed load is 5 kN/m². Floor finishes = 1.5 kN/m². Partition walls = 2 kN/m². Use M20 & Fe415 as materials. Draw the reinforcement details.

Course Outcome 2 (CO2):

1. What are the assumptions made in portal method of analysis of frames?
2. Make use of portal method and analyse a multi-storey building frame, which has three equal bays of 3.5m each and two floors. The height between floors is 4m. The wind loads acting at roof (top floor) and first floor levels are H1=50kN and H2=25kN respectively. The columns and beams are having the same cross section. Compute the forces and moments in columns and beams.
3. A multi-storey building frame has two bays and two floors. The height between floors is 5m. The lengths of first and second bays are 4m and 6m respectively. The wind loads acting at roof (top floor) and first floor levels are H1=75kN and H2=50kN respectively. The columns and beams are having the same cross section. Analyse the frame and design any one beam in the frame using cantilever method. Draw the reinforcement details.

Course Outcome 3 (CO3):

1. What are the IS codal provisions for the design of longitudinal and lateral reinforcement for a pile?
2. Make use of IS codal provisions, design a pile under a column subjected to an axial load of 900kN. The pile is to be driven to a hard stratum available at a depth of 6.5m. Use M20 grade concrete and Fe415 grade steel reinforcement. Draw the reinforcement details also.
3. Make use of IS codal provisions, design a pile cap connecting three piles of size 300mm in diameter used to support a column at the CG of the section subjected to a load of 700kN. The centre-to-centre distance between the piles is 1.60m. Use M20 and Fe415 as materials. Draw the reinforcement details.

Course Outcome 4 (CO4):

1. Define the terms: rise and tread
2. Make use of limit state method, design a dog-legged staircase required for an institutional building having a clear roof height of 3.60m. The size of staircase room is 3m x 6.5m The thickness of roof is 125mm. The live load on the staircase is 3kN/m². Consider other dead loads also. Use M20 and Fe415 as materials. Draw the reinforcement details also
3. Make use of limit state method, design a single flight staircase required for a residential building having a clear roof height of 4.0m. The thickness of roof is 125mm. The live load on the staircase is 3kN/m². Consider other dead loads also. Use M20 and Fe415 as materials. Draw the reinforcement details also.

Course Outcome 5 (CO5):

1. What is the purpose of providing shear key to the retaining wall?
2. Analyse and check the stability of cantilever type retaining wall against overturning, sliding and maximum pressure at toe end using the following data. Height of earth to be retained above the GL: 5.0m; Density of earth: 18 kN/m³; Angle of internal friction: 30°;

SBC of soil: 230 kN/m^2 ; Coeff. of friction between soil and concrete: 0.5; Surcharge load: 10 kN/m^2 .

- Analyse and also check the stability of counterfort type retaining wall against overturning, sliding and maximum pressure at toe end using the following data. Height of earth to be retained above the GL: 8.0m; Density of earth: 18 kN/m^3 ; Angle of internal friction: 30° ; SBC of soil: 240 kN/m^2 ; Coeff. of friction between soil and concrete: 0.5; Surcharge load: 10 kN/m^2 .

Course Outcome 6 (CO6):

- Define the term: Meridional thrust.
- Make use of IS codal provisions, design a circular water tank resting on ground with flexible joint at base storing water of capacity of 300000 litres. The depth of water tank including a free board of 200mm is 3.5m. Use M20 and Fe415 as materials. Draw the reinforcement details also.
- Make use of IS codal provisions, design the sidewalls and ring beam at the junction of sidewalls & top dome of an elevated circular water tank for a capacity of 250,000 litres. Use M25 and Fe500 grade materials. Draw the reinforcement details also.

Concept Map

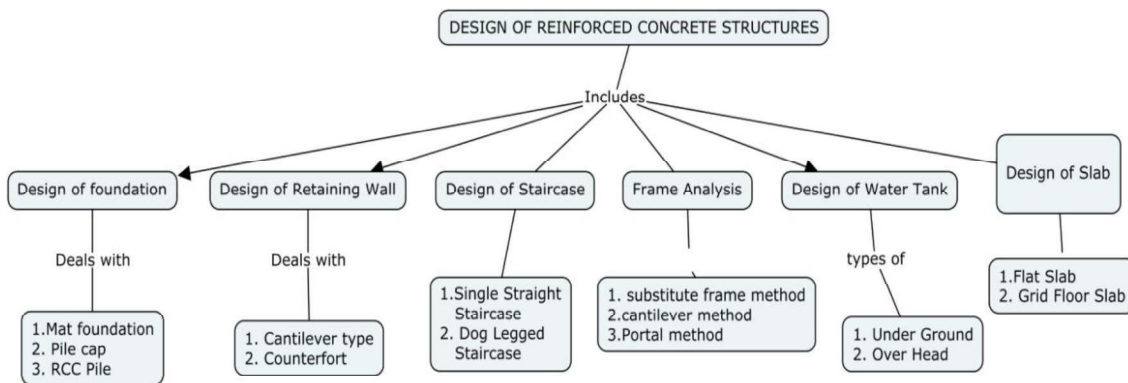

Syllabus

Slabs: Yield line theory - Equilibrium and virtual work method - Analysis and design of square, rectangular and circular slabs; Flat slab and grid floor system; Reinforcement detailing. **Building frames:** Approximate methods - Substitute frame method, Portal and Cantilever methods - Analysis and design of frame components; Reinforcement detailing. **Foundation:** Design principles of mat foundation, Design of piles and pile caps; Reinforcement detailing. **Staircases:** Single flight and dog-legged staircases, Stairs with stringer beams; Reinforcement detailing. **Retaining walls:** Reinforced concrete walls – Cantilever and counterfort retaining walls; Reinforcement detailing. **Water tanks:** Tank resting on ground, underground water tanks and elevated circular water tank; Reinforcement detailing.

Learning Resources

- N. Krishna Raju Advanced Reinforced Concrete Design IS 456-2000, CBS Publishers and Distributors, New Delhi, 2016.
- P.C. Varghese, Advanced Reinforced Concrete Design, Prentice Hall of India, Pvt. Ltd., New Delhi, 2013.
- M.L. Gambhir, Design of Reinforced Concrete structures, Prentice Hall of India Private limited, New Delhi, 2012.

4. N. Subramanian, Design of Reinforced Concrete Structures, Oxford University Press, New Delhi, 2014.
5. B.C. Punmia, Ashok Kumar Jain and Arun Kumar Jain, RCC Designs (Reinforced Concrete Structures), Laxmi Publications Pvt. Ltd., New Delhi, 2015.
6. Self learning materials – online courses - <http://nptel.ac.in/courses/105105104/20>

IS Codes

1. IS 456:2000 Plain and Reinforced Concrete – Code of Practice.
2. IS 875(1-2):1987 Code of Practice for Design Loads (Other than Earthquake) for Buildings and Structures.
3. IS 875(3):2015 Code of Practice for Design Loads (Other than Earthquake) for Buildings and Structures
4. IS 875(4-5):1987 Code of Practice for Design Loads (Other than Earthquake) for Buildings and Structures
5. IS 2911(1): 2010 Design and construction of pile foundations – Code of practice – Concrete piles
6. IS 3370(Part 1-2): 2009 Code of Practice for Concrete Structures for the Storage of Liquids.
7. IS 3370 (Part 4): 1967 Code of Practice for Concrete Structures for the Storage of Liquids
8. SP 16:1980 Design Aids for Reinforced Concrete to IS 456:1978.
9. SP 34:1987 Handbook of concrete reinforcement and detailing.

Course Contents and Lecture Schedule – Theory Part

Module No.	TOPICS	No of Lectures	Course Outcomes
1. Slabs			
1.1	Yield line theory - Analysis and design of square slab and its reinforcement detailing	1	CO1
1.2	Yield line theory - Analysis and design of rectangular slab and its reinforcement detailing	2	CO1
1.3	Yield line theory - Analysis and design of circular slab and its reinforcement detailing	1	CO1
1.4	Design of flat slab and its reinforcement detailing	2	CO1
1.5	Design of grid floor system and its reinforcement detailing	2	CO1
2. Building Frames			
2.1	Analysis and design of a frame using substitute frame method and its reinforcement detailing	2	CO2
2.2	Analysis and design of a frame using Portal method and its reinforcement detailing	2	CO2
2.3	Analysis and design of a frame using cantilever method and its reinforcement detailing	2	CO2
3. Foundation			
3.1	Design principles of mat foundation and its reinforcement detailing	1	CO3
3.2	Design of pile and its reinforcement detailing	1	CO3
3.3	Design of pile cap and its reinforcement detailing	1	CO3
4. Staircases			
4.1	Design of single flight staircase and its reinforcement detailing	2	CO4
4.2	Design of dog-legged staircase and its reinforcement detailing	2	CO4

4.3	Design of stair with stringer beam and its reinforcement detailing	2	CO4
5. Retaining walls			
5.1	Design of cantilever retaining wall and its reinforcement detailing	2	CO5
5.2	Design of counterfort retaining wall and its reinforcement detailing	2	CO5
6. Water tanks			
6.1	Design principles of tank resting on ground	1	CO6
6.2	Design of tank resting on ground and its reinforcement detailing	2	CO6
6.3	Design principles of underground water tank	1	CO6
6.4	Design of underground water tank and its reinforcement detailing	2	CO6
6.5	Design principles of elevated water tank	1	CO6
6.5	Design of elevated water tank and its reinforcement detailing	2	CO6
Total		36	

Course Designers:

1. Dr. M.C.Sundarraja msciv@tce.edu
2. R. Sankaranarayanan rsciv@tce.edu

18CERN0	DESIGN OF STEEL STRUCTURES
----------------	-----------------------------------

Category	L	T	P	Credit
PE	3	-	-	3

Preamble

This course offers the design of steel structures as per limit state method. This course follows the recommendation of IS: 800 – 2007. It aims at determination of safe as well as economical steel components such as plate girders, gantry girders and beam columns. This course also expose the student to IS: 875 provisions for various load calculations. The design of roof truss using rolled and tubular section using IS: 800-2007 is covered in this course. Framed connections such as beam to beam, beam to column connection are also dealt in this course.

Prerequisite

18CE220-Engineering Mechanics, 18CE320-Mechanics of Solids, 18CE530-Design of Steel Structures

Course Outcomes

On the successful completion of the course students will be able to

CO Number	Course Outcome Statement	Weightage*** in %
CO1	Design a Plate girder with intermediate stiffeners and longitudinal stiffeners using the IS800-2007 Provisions.	20
CO2	Analyse and design a gantry girder for its maximum load effects and fatigue effects.	15
CO3	Evaluate the capacity of column subjected to combined axial compression and bending moment.	10
CO4	Calculate all the possible loads on the roof truss and Design the purlins & roof truss members using rolled steel sections.	20
CO5	Design the tubular purlins and tubular roof truss members for the possible effects.	15
CO6	Design the framed connection for beam to beam and beam to column connections	10

*** Weightage depends on Bloom's Level, number of contact hours.

CO Mapping with CDIO Curriculum Framework

CO #	TCE Proficiency Scale	Learning Domain Level			CDIO Curricular Components (X.Y.Z)
		Cognitive	Affective	Psychomotor	
CO1	TPS3	Apply	Value	Mechanism	1.1.1,2.1.1,4.4.1,3.2.5,4.4.2,4.4.3,
CO2	TPS3	Apply	Value	Mechanism	1.1.1,2.1.1,4.4.1,3.2.5,4.4.2,4.4.3,
CO3	TPS3	Apply	Value	Mechanism	1.1.1,2.1.1,4.4.1,3.2.5,4.4.2,4.4.3,
CO4	TPS3	Apply	Value	Mechanism	1.1.1,2.1.1,4.4.1,3.2.5,4.4.2,4.4.3,
CO5	TPS3	Apply	Value	Mechanism	1.1.1,2.1.1,4.4.1,3.2.5,4.4.2,4.4.3,
CO6	TPS3	Apply	Value	Mechanism	1.1.1,2.1.1,4.4.1,3.2.5,4.4.2,4.4.3,

Mapping with Programme Outcomes and Programme Specific Outcomes

Cos	PO1	PO2	PO3	PO4	PO5	PO6	PO7	PO8	PO9	PO10	PO11	PO12	PSO1	PSO2
CO 1	S	M	L	-	-	L	L	M	-	-	L	L	M	L
CO 2	S	M	L	-	-	L	L	M	-	-	L	L	M	L

CO 3	S	M	L	-	-	L	L	M	-	-	L	L	M	L
CO 4	S	M	L	-	-	L	L	M	-	-	L	L	M	L
CO 5	S	M	L	-	-	L	L	M	-	-	L	L	M	L
CO 6	S	M	L	-	-	L	L	M	-	-	L	L	M	L

S- Strong; M-Medium; L-Low

Assessment Pattern: Cognitive Domain

Cognitive Levels	Continuous Assessment Tests			Assignment			Terminal Examination
	1	2	3	1	2	3	
Remember	-	-	-	-	-	-	-
Understand	20	20	20	50	50	50	20
Apply	80	80	80	50	50	50	80
Analyse	-	-	-	-	-	-	-
Evaluate	-	-	-	-	-	-	-
Create	-	-	-	-	-	-	-

Assessment Pattern: Psychomotor

Psychomotor Skill	Miniproject /Assignment/Practical Component
Perception	-
Set	-
Guided Response	50
Mechanism	50
Complex Overt Responses	-
Adaptation	-
Origination	-

Sample Questions for Course Outcome Assessment**

** (2 to 3 at the cognitive level of course outcome)

Course Outcome 1(CO1):

1. What is the difference between plate girder and beam?
2. Determine the buckling resistance moment for a welded plate girder consisting of 500 x 25 mm flange plates and a 1250 x 12 mm web plate in grade 410 steel. Assume a laterally unbraced span of 5.5 m.
3. Design a welded plate girder for a simply supported bridge deck beam with clear span of 20 m subjected to the following:
 - i. Dead load including self weight = 20 KN/m
 - ii. Imposed load = 10 KN/m
 - iii. Two moving loads = 150 KN each spaced 2 m apart

Assume that the top compression flange of the plate girder is restrained laterally

and prevented from rotating. Use mild steel with $f_y=250$ MPa. Design as an unstiffened plate girder with thick webs and also redesign same with intermediate stiffeners utilizing tension field action.

Course Outcome 2(CO2):

1. Design a gantry girder without lateral restraint along its span, to be used in an Industrial building carrying over head traveling crane for the following data:
 - i. Centre to centre distance between columns = 6 m (span of the gantry girder)
 - ii. Crane capacity = 50 KN
 - iii. Self weight of the crane girder excluding trolley = 40 KN
 - iv. Self weight of the trolley, electric motor, hook etc., = 10 KN
 - v. Minimum hook approach = 1 m
 - vi. Wheel centres = 3 m
 - vii. Centre to centre distance between gantry rails = 12 m (span of crane)
 - viii. Self weight of rail section = 100N/m
 - ix. Yield stress of steel = 250 MPa.
2. Why are simply supported girders preferred to two span gantry girders?
3. List the loads that should be consider while designing a gantry girder.

Course Outcome 3(CO3):

1. How can load deflection effects be considered in the design of beam columns?
2. A beam column of length 5 m is subjected to a compression of 800 KN and a major axis moment of 4.5 KNM. The weaker plane of the column is strengthened by bracing. If the effective length factor is 0.8, design the beam column, assuming Fe 410 grade steel.
3. A beam column of length 4.5m is subjected to a compression of 850kN and a major axis moment 40kN-m. The weaker plane of the column is strengthened by bracing. If the effective length factor is 0.8, design the beam column, assuming Fe-410 grade steel. Use two channels welded together to form a box section. No need to design for the welding of the two channels.

Course Outcome 4 (CO4):

1. A fink roof truss is proposed to be constructed at Chennai. The pitch of the roof is $1/4.5$ for a span of 20m. The trusses are spaced at 4.5m c/c. use GI sheeting. The height of the roof above the ground level is 12m. The configuration of the girder is given in figure-

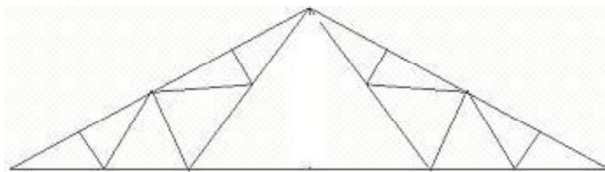

2. The following are the critical loads. Use Fe 410 grade steel. ISMC 150 purlins are placed only on the nodes. The truss is supported on a RCC column of size 450 x 450 mm of M30 grade concrete. Design the ridge connection and the base connection.

Members	Critical Forces in Kn	
	Compression	Tension
Principal Rafter	85	65
Tie Member	65	97.5
Main Sling & Main Strut	30	33.5
Minor sling & Minor Strut	22.5	24

3. How Channel purlin will behave in DL+LL and DL + WL load combinations?
4. Design a channel purlin for fink type roof truss using the following data:
- Spacing of roof truss - 4.5 m
 - Spacing of purlin along sloping length - 1.4 m
 - Maximum DL = 5kN (C) ; LL = 3kN (C) and WL= 11kN (T)

Course Outcome 5 (CO5):

1. An industrial building is shown in fig. the frames are at 5m centres and the length of the building is 40m. The purlin spacing of the roof is as shown in figure-1. The Building is situated in Delhi. Assume live and wind loads as per IS875 (part 2 and Part 3) and the roof is covered with GI sheeting. Design the roof truss using angle members and gusseted joints. The truss is to be fabricated using welded joints into two parts for transport and assembled at site using bolted joints at A, B and C as shown in figure-1(b).

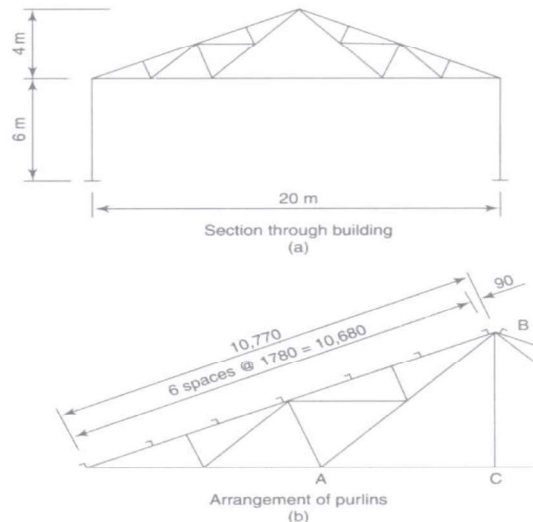

- List out various elements of the roof truss and mark all its significance.
- Estimate the capacity of the tubular principal rafter subjected to a compression of 125kN and a tensile force of 80 kN under the reversal effect. The member also subjected to a bending effect of 15kN-m under DL+LL and 9kN-m under DL+WL. Use Yst240 (Yst25)

Course Outcome 6(CO6):

1. Evaluate the bolted web cleat connection between a main beam ISMB300 and a coped beam of size ISMB250 which transfers a load of 50kN maximum reaction. Use M16 bolts of Gr.8.8.
2. Explain the force transfer mechanism of top and seat connection.
3. Evaluate the bolted top and bottom seat connection between a main beam ISMB400 and a column of size ISMB500 which transfers a load of 200kN maximum reaction. Use M16 bolts of Gr.8.8

Concept Map

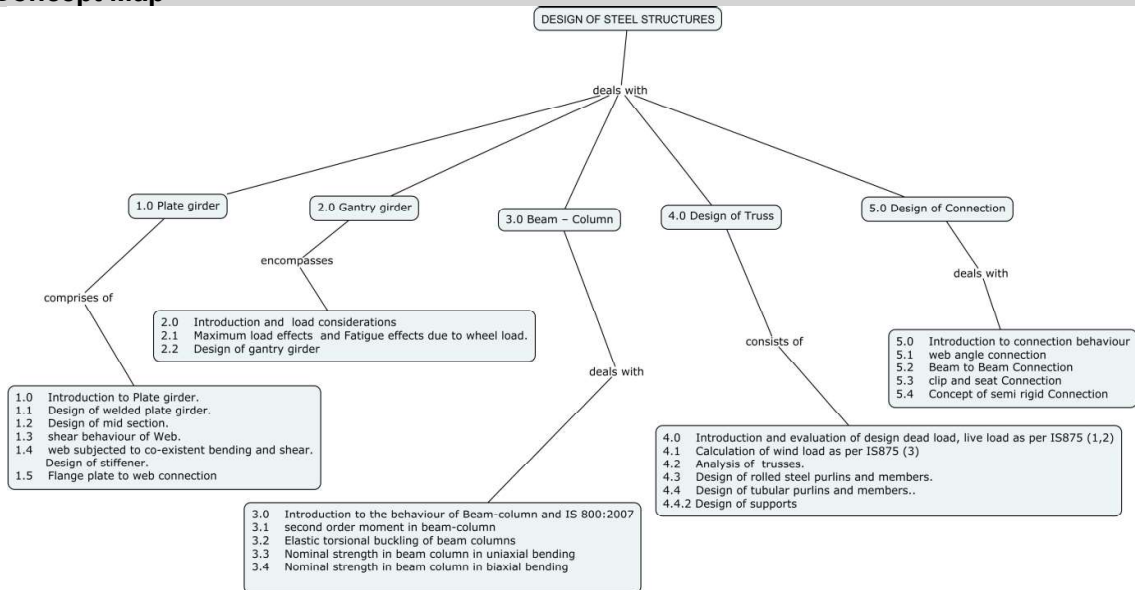

Syllabus

Plate girder- Introduction to Plate girder, Difference between beam and plate girder, Design of welded plate girder, Proportioning of web and flange plates, Design of mid-section, Curtailment of flange plates, shear behaviour of transversely unstiffened and stiffened web, web subjected to co-existent bending and shear, transverse web stiffener, Bearing stiffener, end bearing stiffener and load bearing stiffener, Longitudinal web stiffener, Flange plate to web connection, Splices - Flange and web. **Gantry girder:** Introduction, load considerations, max load effects, Fatigue effects, Determination of maximum bending moment and shear force due vertical component of crane wheel load, horizontal component of crane wheel load, longitudinal effect of wheel load, Design of gantry girder, Connection in gantry girder. **Beam - Column:** Introduction, behaviour of beam-column, second order moment in beam-column, Elastic torsional buckling of beam columns, Nominal strength in beam column in uniaxial bending, Biaxial bending. **Design of Truss:** Introduction, Evaluation of design dead load, live load, wind load. Review of analysis of truss. **Design of Truss using Rolled steel sections:** Purlins, truss members, Supports. **Design of Truss using tubular sections:** Purlins, truss members, supports. **Design of Beam column Connection:** Introduction, web angle connection, Beam to Beam Connection, Beam to

column connection, web angle connection and clip and seat Connection, Concept of semi rigid Connection.

Indian Standard Codes

1. IS: 800 – 2007, Code of Practice for general construction in steel, BIS, New Delhi
2. SP 6 (1) – Structural steel sections
3. IS 875 (1-5) - 1987 Code of practice for Design Loads (Other than Earthquake) for Buildings and Structures, BIS
4. IS 816 :1969 - Code of practice for Metal Arc Welding for general Construction in Mild Steel, BIS
5. IS 1161:1998 – Steel tubes for structural purposes – specifications, BIS.
6. IS: 808 – 1989 Dimensions For Hot Rolled Steel Beam, Column, Channel and Angle Sections.

Learning Resources

1. Teaching Resource for Structural Steel Design, Vol. 1,2,3 (2000), INSDAG- Institute for Steel Development and Growth, Kolkatta.
2. Subramanian, N., (2008), Design of Steel Structures, oxford university press, USA,.
3. Gaylord E H, Gaylord N C and Stallmeyer J E, “Design of Steel Structures”, 3rd edition, McGraw Hill Publications, 1992.
4. Salmon, Johnson & Malhas,” Steel Structures: Design and Behavior, 5th Edition, Pearson
5. Negi L.S. “Design of steel structures” McGraw Hill Co., New Delhi, 2014
6. Duggal S.K., “Limit state design of steel structures” McGraw Hill Co., New Delhi, 2014
7. www.nptel.ac.in
8. http://www.steel-insdag.org/TM_Content.asp

Course Contents and Lecture Schedule

Module No.	Topic	No. of Lectures	Course Outcome
	Plate girder		
1.0	Introduction to Plate girder – Difference between beam and plate girder & IS 800-2007.	1	CO1
1.1	Design of welded plate girder	2	
1.2	Proportioning of web and flange plates – Design of mid section		
1.2.1	Curtailment of flange plates		
1.3	shear behaviour of transversely unstiffened and stiffened web	2	
1.4	web subjected to co-existent bending and shear	1	
1.4.1	transverse web stiffener – Bearing stiffener	3	
1.4.2	end bearing stiffener and load bearing stiffener –		
1.4.3	Longitudinal web stiffener		
1.5	Flange plate to web connection	1	

1.5.1	Splices - Flange and web		
	Gantry girder		
2.0	Introduction and load considerations	1	CO2
2.1	Maximum load effects and Fatigue effects		
2.1.1	Determination of maximum bending moment and shear force due vertical component of crane wheel load	1	
2.1.2	Determination of maximum bending moment and shear force due horizontal component of crane wheel load and longitudinal effect of wheel load	1	
2.2	Design of gantry girder	1	
2.2.1	Connection in gantry girder		
	Beam – Column		
3.0	Introduction to the behaviour of Beam-column and IS 800:2007	1	CO3
3.1	second order moment in beam-column	1	
3.2	Elastic torsional buckling of beam columns		
3.3	Nominal strength in beam column in uniaxial bending	1	
3.4	Nominal strength in beam column in biaxial bending	1	
	Tutorial	2	
	Design of Truss		
4.0	Introduction and evaluation of design dead load, live load as per IS875 (1,2)	1	CO4
4.1	Calculation of wind load as per IS875 (3)	1	
4.2	Analysis of trusses	1	
	Design of Truss using Rolled steel sections		
4.3	Design of purlins	1	
4.3.1	Design of members of Truss using Rolled steel sections	2	
4.3.2	Design of supports	1	
	Design of Truss using tubular sections		
4.4	Design of tubular purlins	2	CO5
4.4.1	Design of members of Truss using Rolled steel sections	2	
4.4.2	Design of supports	1	
	Design of Connection		
5.0	Introduction to connection behaviour	2	CO6
5.1	web angle connection		
5.2	Beam to Beam Connection		
5.3	Beam to column Connection	2	
5.3.1	clip and seat Connection		

5.4	Concept of semi rigid Connection		
-----	----------------------------------	--	--

Course Designers:

1. Dr.S.Arulmary samciv@tce.edu
2. Ms. G.Celine Reena celinereena@tce.edu

18CE1A0	ARBITRATION AND DISPUTE RESOLUTION
----------------	---

Category	L	T	P	Credit
PE	1	0	0	1

Preamble

This course will create awareness on contracts for construction industry, laws on arbitration, arbitration procedure and laws on dispute resolution in India.

Prerequisite

NIL

Course Outcomes

On the successful completion of the course students will be able to

CO Number	Course Outcome Statement	Weightage*** in %
CO1	Enumerate the laws on contracts for construction industry in India, procedure for arbitration and dispute resolution	20
CO2	Apply appropriate methods to assess the critical factors in contracts leading to arbitration and disputes between the parties	40
CO3	Suggest suitable type of arbitration or dispute resolution for the situation of problem	40

*** Weightage depends on Bloom's Level, number of contact hours,

CO Mapping with CDIO Curriculum Framework

CO #	TCE Proficiency Scale	Learning Domain Level			CDIO Curricular Components (X.Y.Z)
		Cognitive	Affective	Psychomotor	
CO1	TPS2	Understand	Response	Guided Response	1.1,2.3.1,2.3
CO2	TPS3	Apply	Value	Mechanisms	1.1,2.3.1,2.3.2,3.2.1,4.1.6
CO3	TPS3	Apply	Value	Mechanisms	1.1,2.3.1,2.3.2,3.2.1,4.1.6,4.3.4,4.6.5

Mapping with Programme Outcomes and Programme Specific Outcomes

Cos	PO1	PO2	PO3	PO4	PO5	PO6	PO7	PO8	PO9	PO10	PO11	PO12	PSO1	PSO2
CO1	M	L	-	-	L	-	-	-	-	-	M	-	L	-
CO2	S	M	-	-	M	-	-	-	-	-	M	-	L	-
CO3	S	M	-	-	M	-	-	-	-	-	M	-	L	-

S- Strong; M-Medium; L-Low

Assessment Pattern: Cognitive Domain

Cognitive Levels	Continuous Assessment Tests		Terminal Examination
	Test 1	Test 2	
Remember	30	30	30
Understand	40	40	40

Apply	30	30	30
Analyze			
Evaluation			
Create			

Assessment Pattern: Psychomotor

Psychomotor Skill	Mini project/Assignment/Practical Component
Perception	
Set	
Guided Response	
Mechanism	
Complex Overt Responses	
Adaptation	
Origination	

Sample Questions for Course Outcome Assessment**

** (2 to 3 at the cognitive level of course outcome)

Course Outcome1(CO1):

1. Mention various types of contracts
2. Write the essentials of contract
3. Discuss the essentials and clauses of contract

Course Outcome2(CO2):

1. Differentiate between Negotiation, mediation and reconciliation.
2. Explain the dispute resolution mechanism in Indian system.
3. There is a dispute between the contractor and the funding organization of a project on interpretation of quantum of work for payment of wages to the contractor. As an arbitrator for this case, discuss the procedure and powers you would exercise to settle the dispute in an unbiased manner.

Course Outcome3(CO3):

1. Explain the litigation in the Indian courts on disputes.
2. A highway is under distress which requires repair. The repair is to be let out as contracting work by calling for tenders. Identify a suitable type of contract that can be undertaken for the repair work with suitable reasons.

Concept Map

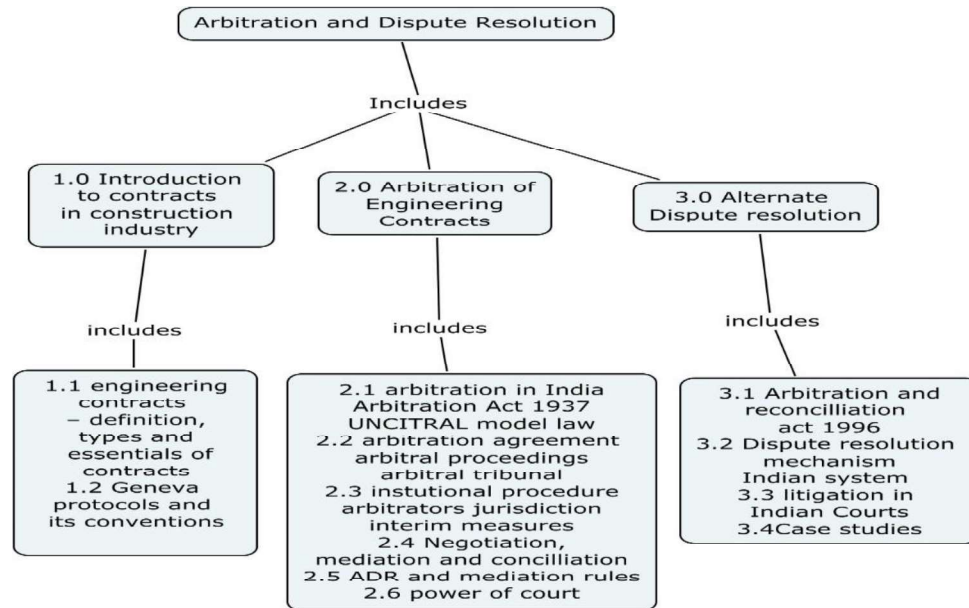

Syllabus

Introduction to contracts in construction industry: Brief details of engineering contracts – definition, types and essentials of contracts, – brief details of Geneva protocols and its conventions. **Arbitration of Engineering Contracts** – Background of Arbitration in India, Indian Arbitration Act 1937, UNCITRAL model law, **forms of arbitration** – arbitration agreement, Commencement of arbitral proceedings, Constitution of arbitral tribunal, Institutional procedure of arbitration, Impartiality and independence of arbitrators jurisdiction of arbitral tribunal, Interim measures, Enforcement of awards. Negotiation, Mediation and conciliation – concepts and purpose, statutory back ground ADR and mediation rules, Duty of mediator and disclose facts, Power of Court in mediation. **Alternate Dispute resolution** - Structure of Indian Judicial, The arbitration and reconciliation ordinance 1996, The dispute resolution mechanism under the Indian judicial System, Litigation in Indian courts, case studies.

Learning Resources

1. B.J. Vasavada, "Engineering Contracts and Arbitration", Jubilee Publications, 1996
2. Roshan Namavati, "Professional Practice", Lakhani Book Depot, 2013

Course Contents and Lecture Schedule

Module No.	Topic	No. of Hours	Course Outcome
1.0	Introduction to contracts in construction industry		
1.1	Brief details of engineering contracts – definition, types and essentials of contracts, clauses of contract	1	CO1
1.2	Brief details of Geneva protocols and its conventions.	1	CO1
2.0	Arbitration of Engineering Contracts		
2.1	Background of Arbitration in India, Indian Arbitration Act 1996, UNCITRAL model law	1	CO2
2.2	Forms of arbitration – arbitration agreement, Commencement of arbitral proceedings, Constitution of arbitral tribunal	1	CO2
2.3	Institutional procedure of arbitration, Impartiality and independence of arbitrator's jurisdiction of arbitral tribunal,	2	CO2

	Interim measures, Enforcement of awards.		
2.4	Negotiation, Mediation and conciliation – concepts and purpose	1	CO2
2.5	Statutory back ground ADR and mediation rules	1	CO2
2.6	Duty of mediator and disclose facts, Power of Court in mediation.	1	CO2
3.0	Alternate Dispute resolution		
3.1	Structure of Indian Judicial, The arbitration and reconciliation ordinance 1996	1	CO3
3.2	The dispute resolution mechanism under the Indian judicial System	1	CO3
3.3	Litigation in Indian courts	1	CO3
3.4	case studies	2	CO3
	Total Periods	14	

Course Designers:

- Er. SannaRatnavel, Sceba Consultancy Services, Madurai, ratsit@gmail.com

18CE1B0	GREEN CONSTRUCTION	Category	L	T	P	Credit
		PE	1	0	0	1

Preamble

This course will create awareness on the impact of constructions on the environment and the various techniques of mitigating the adverse impacts

Prerequisite

Knowledge on building construction

Course Outcomes

On the successful completion of the course students will be able to

CO Number	Course Outcome Statement	Weightage*** in %
CO1	Enumerate the aspects of green construction and certification systems	10
CO2	Select materials and appropriate construction technologies for the green construction	20
CO3	Plan green buildings knowing various innovative techniques	10
CO4	Apply concept of sustainability to various construction activities	20
CO5	Suggest Mitigation measures for environmental degradation	20
CO6	Address Impact of Life cycle effects, durability and certification process	20

*** Weightage depends on Bloom's Level, number of contact hours,

CO Mapping with CDIO Curriculum Framework

CO #	TCE Proficiency Scale	Learning Domain Level			CDIO Curricular Components (X.Y.Z)
		Cognitive	Affective	Psychomotor	
CO1	TPS2	Understand	Response	Guided Response	1.1,2.3.1,2.3.2,3.2.1,4.1.6

CO2	TPS2	Understand	Response	Guided Response	1.1,2.3.1,2.3.2,3.2.1,4.1.6
CO3	TPS3	Apply	Value	Mechanisms	1.1.1,2.3.2,2.4.4,2.4.7,3.2.1,4.3.4,4.4.5
CO4	TPS3	Apply	Value	Mechanisms	1.1.1,2.3.2,2.4.4,2.4.7,3.2.1,4.3.4,4.4.5
CO5	TPS3	Apply	Value	Mechanisms	1.1.1,2.3.2,2.4.4,2.4.7,3.2.1,4.3.4,4.4.5
CO6	TPS3	Apply	Value	Mechanisms	1.1.1,2.3.2,2.4.4,2.4.7,3.2.1,4.3.4,4.4.5,4.4.6

Mapping with Programme Outcomes and Programme Specific Outcomes

Cos	PO1	PO2	PO3	PO4	PO5	PO6	PO7	PO8	PO9	PO10	PO11	PO12	PSO1	PSO2
CO1	M	L	-	-	-	-	M	-	-	-	-	-	-	-
CO2	M	L	-	-	-	-	-	-	-	-	L	-	L	-
CO3	S	M	-	-	-	-	-	L	L	-	L	-	L	L
CO4	S	M	-	-	-	M	S	L	-	L	L	-	L	L
CO5	S	M	-	-	-	M	S	-	-	L	L	-	-	L
CO6	S	M	-	-	-	-	-	-	-	-	M	L	-	-

S- Strong; M-Medium; L-Low

Assessment Pattern: Cognitive Domain

Cognitive Levels	Continuous Assessment Tests	Terminal Examination
	1	
Remember	10	10
Understand	50	40
Apply	40	50
Analyze		
Evaluate		
Create		

Assessment Pattern: Psychomotor

Psychomotor Skill	Mini project/Assignment/Practical Component
Perception	
Set	
Guided Response	
Mechanism	
Complex Overt Responses	
Adaptation	
Origination	

Sample Questions for Course Outcome Assessment**

** (2 to 3 at the cognitive level of course outcome)

Course Outcome1(CO1):

1. Write the meaning of green construction mentioning its need
2. Discuss the various aspects and measures taken to make a building green
3. Enumerate the salient features of green certification systems with purpose

Course Outcome2(CO2):

1. List few materials used in green construction
2. Relate sustainability with green construction with reasons
3. As a civil engineer having the knowledge on green construction, identify the material and technologies you would recommend for your buildings to attain sustainability. Discuss with suitable reasons

Course Outcome3(CO3):

1. Discuss the principles of planning for green construction
2. Enumerate various innovative technologies for green buildings
3. Differentiate green and smart buildings with examples

Course Outcome 4 (CO4):

1. Define desertification and its relation with sustainability
2. Identify strategies you would consider for implementation of an eco- development programme for Madurai city
3. With the knowledge of green construction materials identify suitable measures to minimize environmental impacts in construction projects

Course Outcome 5 (CO5):

- Relate development with environmental degradation
2. Suggest suitable scheme to protect and enhance the living environment in and around TCE campus
 3. For an existing traditional building identify suitable technologies to convert it into a green building with cost effectiveness

Course Outcome6(CO6):

Address Impact of Life cycle effects, durability and certification process

1. Compare GRIHA and IGBC rating systems
2. Discuss the measures/ schemes contributing to good construction practice
3. Enumerate the techniques you would implement for energy saving in your residence

Concept Map

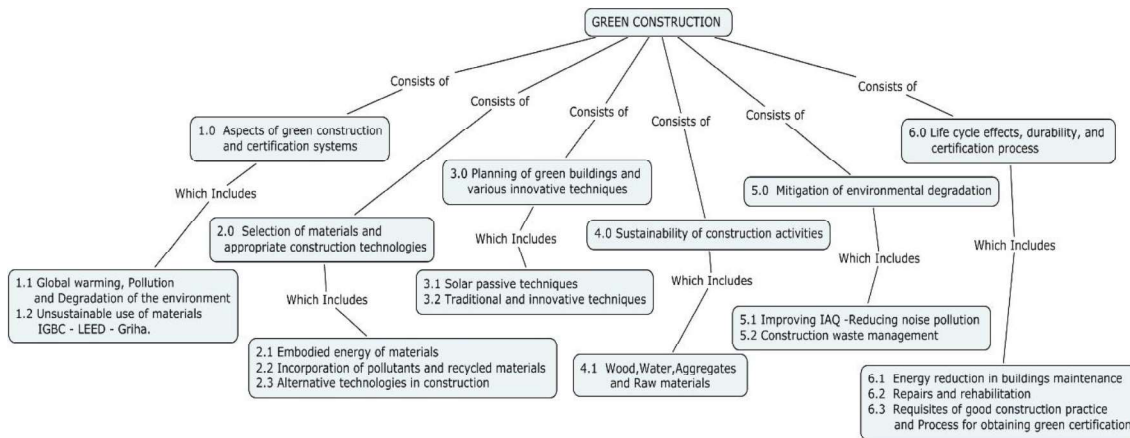

Syllabus

Aspects of green construction and certification systems: Global warming - Pollution - Degradation of the environment - Unsustainable use of materials - IGBC - LEED - GRIHA. **Selection of materials and appropriate construction technologies:** Embodied energy of materials - incorporation of pollutants and recycled materials - alternative technologies in construction. **Planning of green buildings and various innovative techniques:** Solar passive techniques - traditional and innovative techniques. **Sustainability of construction activities:**

Wood - Water - Aggregates - Raw materials. **Mitigation of environmental degradation:** Improving IAQ - reducing noise pollution - construction waste management. **Life cycle effects, durability, and certification process:** Energy reduction in buildings maintenance - Repairs and rehabilitation - Requisites of good construction practice - Process for obtaining green certification.

Learning Resources

1. Bureau of Energy Efficiency, "Energy Conservation Building Code 2007", Ministry of Power, Government of India
2. Wright, R.T., and Nebel, B.J., "Environmental Science - Toward a Sustainable Future", 2002, Prentice-Hall of India Private Limited, New Delhi
3. Jagadish, K.S., Venkatarama Reddy, B.V., Nanjunda Rao, K.S., "Alternative Building Materials and Technologies", 2007, New Age International (P) Limited
4. CII and IGBC, "Training Programme on 'LEED' Green Building Rating System" USGBC, "Green Building Rating System for New Construction and Major Renovations - Version 2.2", 2005

Course Contents and Lecture Schedule

Module No.	Topic	No. of Hours	Course Outcome
1.0 Aspects of green construction and certification systems			
1.1	Global warming, Pollution & Degradation of the environment	1	CO1
1.2	Unsustainable use of materials - IGBC - LEED - Griha	1	CO1
2.0 Selection of materials and appropriate construction technologies			
2.1	Embodied energy of materials	1	CO2
2.2	Incorporation of pollutants and recycled materials	1	CO2
2.3	Alternative technologies in construction	1	CO2
3.0 Planning of green buildings and various innovative techniques			
3.1	Solar passive techniques	1	CO3
3.2	Traditional and innovative techniques	1	CO3
4.0 Sustainability of construction activities			
4.1	Wood, Water, Aggregates & Raw materials	2	CO4
5.0 Mitigation of environmental degradation			
5.1	Improving IAQ - Reducing noise pollution	1	CO5
5.2	Construction waste management	1	CO5
6.0 Life cycle effects, durability, and certification process			
6.1	Energy reduction in buildings maintenance	1	CO6
6.2	Repairs and rehabilitation	1	CO6
6.3	Requisites of good construction practice & Process for obtaining green certification	1	CO6
TOTAL		14 Hrs	

Course Designers:

1. Er. S.P. Srinivasan, MD, ES Consultancy Services, Madurai er.spsvasan@gmail.com

18CE1C0	PRECAST TECHNOLOGY IN BUILDINGS
----------------	--

Category	L	T	P	Credit
PE	1	0	0	1

Preamble

Precast is an industrialized way to build. It means transfer of work from sites to factories which improves productivity, quality and shortens construction time of a building. Precast also has lower lifetime costs than any other building solution. This is possible due to consistent high quality of industrially produced products. Precast suits well for any type of building namely; residential, commercial, industrial, public etc. This course gives an exposure on the need and importance of using precast technology along with awareness on the technology.

Prerequisite

Knowledge on building construction

Course Outcomes

On the successful completion of the course students will be able to

CO Number	Course Outcome Statement	Weightage*** in %
CO1	Compare Precast and cast in-situ technology with implementation challenges	20
CO2	Explain the details of production erection of Hollow core slab with precautions to be taken	20
CO3	Identify the planning aspects for precast projects along with Machinery usage	20
CO4	Enumerate the details of Stacking, Handling, Transportation and Erection of precast elements with precautions	20
CO5	Discuss the fixing and jointing in precast buildings with construction sequence	20

*** Weightage depends on Bloom's Level, number of contact hours,

CO Mapping with CDIO Curriculum Framework

CO #	TCE Proficiency Scale	Learning Domain Level			CDIO Curricular Components (X.Y.Z)
		Cognitive	Affective	Psychomotor	
CO1	TPS2	Understand	Response	Guided Response	1.1,2.3.1,2.3.2,3.2.1,4.1.6
CO2	TPS2	Understand	Response	Guided Response	1.1,2.3.1,2.3.2,3.2.1,4.1.6
CO3	TPS2	Understand	Response	Guided Response	1.1,2.3.1,2.3.2,3.2.1,4.1.6
CO4	TPS3	Apply	Value	Mechanisms	1.1.1,2.3.2,2.4.4,2.4.7,3.2.1,4.3.4,4.4.5
CO5	TPS3	Apply	Value	Mechanisms	1.1.1,2.3.2,2.4.4,2.4.7,3.2.1,4.3.4,4.4.5

Mapping with Programme Outcomes and Programme Specific Outcomes

Cos	PO1	PO2	PO3	PO4	PO5	PO6	PO7	PO8	PO9	PO10	PO11	PO12	PSO1	PSO2
CO 1	M	L	-	-	-	-	M	-	-	-	-	-	-	-
CO	M	L	-	-	-	-	-	-	-	M	-	-	-	-

2														
CO 3	M	L	-	-	-	M	L	-	M	M	M	L	L	L
CO 4	S	M	-	-	-	-	L	-	L	M	-	-	L	L
CO 5	S	M	-	-	-	-	-	-	-	M	-	-	L	-

S- Strong; M-Medium; L-Low

Assessment Pattern: Cognitive Domain

Cognitive Levels	Test 1	Terminal Examination
Remember	20	20
Understand	50	40
Apply	30	40
Analyze	0	0
Evaluation	0	0
Create	0	0

Assessment Pattern: Psychomotor

Psychomotor Skill	Miniproject/Assignment/Practical Component
Perception	
Set	
Guided Response	
Mechanism	
Complex Overt Responses	
Adaptation	
Origination	

Sample Questions for Course Outcome Assessment**

** (2 to 3 at the cognitive level of course outcome)

Course Outcome1(CO1):

1. Mention the need and advantages of using precast technology
2. Define the term modular co-ordination mentioning its purpose
3. Discuss the challenges that would be faced while implementing precast technology in relation to Indian context

Course Outcome2(CO2):

1. Explain the details to be noted in the production of hollow core slabs
2. Discuss the merits of hollow core slabs over solid slabs mentioning the applications of each
3. Enumerate the precautions to be taken in erection of hollow core slabs mentioning its need

Course Outcome3(CO3):

1. Explain the points you would consider in planning of precast projects
2. As an engineer in-charge of precast installation illustrate the provisions and precautions you would consider in jointing of components

3. Discuss the machinery used with purpose in precast construction

Course Outcome 4 (CO4):

1. As an engineer discuss the process of stacking of precast units considering a specific unit with precautions to be taken
2. Discuss the points to be considered in transportation of precast units
3. Discuss the precautions to be taken while erection of precast elements

Course Outcome 5 (CO5):

1. As an site engineer identify the sequence of fixing and jointing of wall panels in a buildings
2. Discuss the tolerances to be provided while fixing and jointing of precast elements
3. Discuss the good practices in jointing of elements

Concept Map

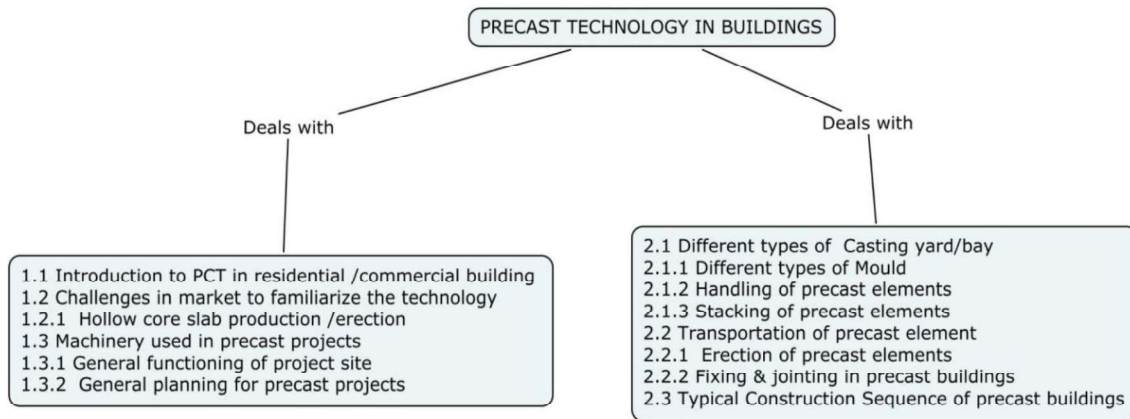

Syllabus

Introduction to precast technology in residential /commercial building - Challenges in market to familiarize the technology - Hollow core slab production /erection -Machinery used in precast projects -General functioning of project site -General planning for precast projects - Different types of Casting yard/bay - Different types of Mould - Handling of precast elements - Stacking of precast elements -Transportation of precast element - Erection of precast elements - Fixing & jointing in precast buildings - Typical Construction Sequence of precast buildings.

Learning Resources

1. IS: 15916 -2011, “Building Design and Erection using Prefabricated Concrete – Code of Practice”
2. NBN EN 1168-2005, “Precast Concrete Products - Hollow Core Slabs”

Course Contents and Lecture Schedule

Module No.	Topic	No. of Hours	Course Outcome
1.0	Precast Technologies in Buildings		

Module No.	Topic	No. of Hours	Course Outcome
1.1	Introduction to Precast Technologies in residential and commercial buildings	1	CO1
1.2	Challenges in implementation of Precast Technologies	1	CO1
1.2.1	Hollow Core slab production/ erection	1	CO2
1.3	Machineries used for precast projects	1	CO2
1.3.1	General functions of project site	1	CO
1.3.2	General planning for precast projects	1	CO3
2.0	Installation of precast products		
2.1	Types of casting yards/ bay for precast products	1	CO3
2.1.1	Different types of moulds used for precast products	1	CO3
2.1.2	Handling of precast elements	1	CO4
2.1.3	Stacking of precast elements	1	CO4
2.2	Transportation of precast elements	1	CO4
2.2.1	Erection of precast elements	1	CO4
2.2.2	Fixing and jointing in precast buildings	1	CO5
2.3	Typical construction sequence of precast buildings	1	CO5
TOTAL		14	

Course Designers:

- Mr. R. Karunanithi, karunanithi@Intecc.com
L&T, Bangalore

18CE1D0	FRAMING OF STRUCTURES AND OPTIMUM FOUNDATION SYSTEMS
----------------	---

Category	L	T	P	Credit
PE	1	0	0	1

Preamble

This course is framed to give an overview on the guidelines for idealisation and basic concepts in framing of structures along with optimum foundation systems.

Prerequisite

Knowledge on structural analysis and design of RCC and Steel elements

Course Outcomes

On the successful completion of the course students will be able to

CO Number	Course Outcome Statement	Weightage*** in %
CO1	Understand the concept of load transferring mechanism and various components of structures.	20
CO2	Enumerate the details of RCC structural behaviour and their Reinforcement detailing	30
CO3	Enumerate the details of Steel structural behaviour and their Reinforcement detailing	20
CO4	Identify and choose an appropriate foundation systems for a given situation	30

*** Weightage depends on Bloom's Level, number of contact hours,

CO Mapping with CDIO Curriculum Framework

CO #	TCE Proficiency Scale	Learning Domain Level			CDIO Curricular Components (X.Y.Z)
		Cognitive	Affective	Psychomotor	
CO1	TPS2	Understand	Response	Guided Response	1.1,2.3.1,2.3.2,3.2.1,4.1.6
CO2	TPS2	Understand	Response	Guided Response	1.1,2.3.1,2.3.2,3.2.1,4.1.6
CO3	TPS3	Apply	Value	Mechanisms	1.1.1,2.3.2,2.4.4,2.4.7,3.2.1,4.3.4,4.4.5
CO4	TPS3	Apply	Value	Mechanisms	1.1.1,2.3.2,2.4.4,2.4.7,3.2.1,4.3.4,4.4.5

Mapping with Programme Outcomes and Programme Specific Outcomes

Cos	PO1	PO2	PO3	PO4	PO5	PO6	PO7	PO8	PO9	PO10	PO11	PO12	PSO1	PSO2
CO 1	M	L	-	-	-	-	-	-	-	-	-	-	L	-
CO 2	M	L	-	-	-	-	-	-	-	-	-	L	L	-
CO 3	S	M	-	-	-	-	-	-	-	-	-	L	L	-
CO 4	S	M	-	-	-	-	-	-	-	-	-	-	L	-

S- Strong; M-Medium; L-Low

Assessment Pattern: Cognitive Domain

Cognitive Levels	Test 1	Terminal Examination
Remember	20	20
Understand	50	40
Apply	30	40
Analyze	0	0
Evaluation	0	0
Create	0	0

Assessment Pattern: Psychomotor

Psychomotor Skill	Miniproject/Assignment/Practical Component
Perception	
Set	
Guided Response	
Mechanism	
Complex Overt Responses	
Adaptation	
Origination	

Sample Questions for Course Outcome Assessment**

** (2 to 3 at the cognitive level of course outcome)

Course Outcome1(CO1):

1. Mention the meaning of framed structures with its purpose
2. Discuss the load transfer mechanism in framed structures
3. Compare Frame structures with Normal Load bearing Traditional High Rise Building

Course Outcome2(CO2):

1. Discuss the structural behaviour of framed structures
2. Discuss the do's and dont's in detailing of RCC beam
3. By means of a sketch explain the points to be considered at the junction of framed structures

Course Outcome3(CO3):

1. Enumerate the precautions to be noted while designing steel framed structures
2. Discuss the behaviour of steel structural members in seismic prone areas
3. Draw and explain the junction details to be provided for steel and concrete structures

Course Outcome 4 (CO4):

1. List the types of foundation systems to be used in framed structures
2. Discuss the guidelines to be used in design of optimum foundation systems for framed structures
3. Identify an appropriate foundation system for a framed structure in a seismic prone area and discuss the guidelines for construction

Concept Map

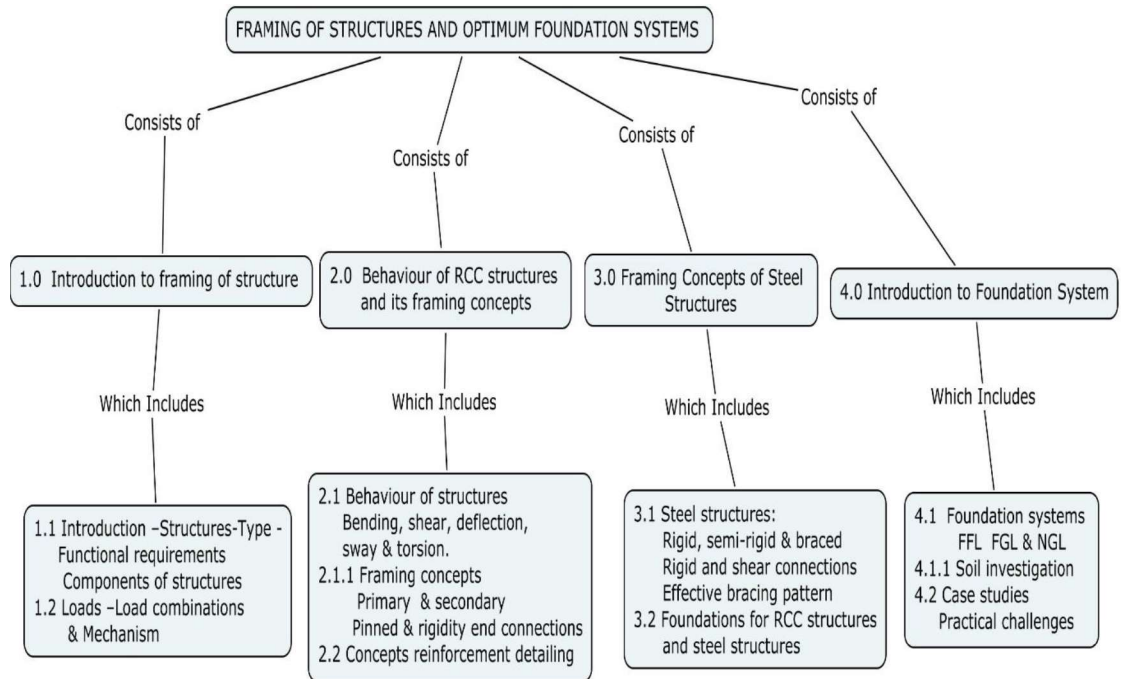

Learning Resources

1. P. Purushothaman, “Reinforced Concrete Structural Elements: Behaviour, Analysis and Design”, 1984, McGraw-Hill Inc.,US.
2. S.Unnikrishna Pillai, Devdas Menon, “Reinforced concrete design”, 2005, Tata McGraw Hill Publishing Co. Ltd.
3. S.K.Duggal, “Design of Steel Structures”, 2000, Tata McGraw Hill Education
4. IS 456: 2000: Code of Practice for Plain and Reinforced Concrete
5. IS 800: 2007: Code of Practice –General construction in steel.

Course Contents and Lecture Schedule

Module No.	Topics	No. of Lectures	CO
1.0	Introduction to framing of structure		CO1
1.1	Introduction –Structures-Types- Functional requirements of structures and its components. Components of structures.	1	CO1
1.2	Loads – appropriate Loading considerations in various structures. Load path and load transfer mechanism- Load combinations	2	CO1
2.0	Behaviour of RCC structures and its framing concepts		
2.1	Behaviour of structures – Bending, shear, deflection, sway & torsion.	2	CO2
2.2	Framing concepts -Primary beams & secondary beams concepts. Pinned & rigidity end connections	1	CO2
2.2.1	Concepts using reinforcement detailing with practical implications in RCC structures	1	CO2

Module No.	Topics	No. of Lectures	CO
3.0	Framing Concepts of Steel Structures		
3.1	Framing concepts – steel structures-Rigid, semi-rigid & braced Structures Rigid and shear connections of steel beams – Effective bracing pattern	2	CO3
3.2	Foundation systems – overview- Explanation on Foundations for RCC structures and steel structures.	1	CO3
4.0	Introduction to Foundation System		CO3
4.1	Foundation systems –FFL (finished floor levels), FGL (Finished ground level) , NGL (Natural ground level).	1	CO4
4.1.1	Soil investigation report study- required inputs from soil investigation	1	CO4
4.2	Overall Discussions/Q&A/ Case studies/Practical challenges in design and construction	2	CO4
	TOTAL	14	

Course Designers:

1. S. Prasanna, Assistant Manager
Structural Design, L&T, Chennai s.l.prasanna@gmail.com

18CE1E0	LARGE SCALE SYSTEMS
----------------	----------------------------

Category	L	T	P	Credit
PE	1	0	0	1

Preamble

The aim of this course is to sensitize the undergraduates about the basic concepts of systems engineering methodologies to approach the Socio-Techno problems in a holistic manner. This course will address the basic concepts of cause-effect impacts due to the interrelationships of components and elements of systems in a complex environment.

Prerequisite

NIL

Course Outcomes

On the successful completion of the course students will be able to

CO Number	Course Outcome Statement	Weightage*** in %
CO1	Identify tools for process of forecasting and assessment -the indented and unintended impacts on policies and technological solutions	25
CO2	Participate and coordinate in group discussions in organizations.	20
CO3	Understand the components and elements involved in DPR, FR, EIA, EMS and Resettlement & Rehabilitations programs.	25
CO4	Understand the problem situation for higher level policy discussion on any societal and technological issues seamlessly in all domains.	30

*** Weightage depends on Bloom's Level, number of contact hours,

CO Mapping with CDIO Curriculum Framework

CO #	TCE Proficiency Scale	Learning Domain Level			CDIO Curricular Components (X.Y.Z)
		Cognitive	Affective	Psychomotor	
CO1	TPS2	Understand	Response	Guided Response	1.1,2.3.1,2.3.2,3.2.1,4.1.6
CO2	TPS2	Understand	Response	Guided Response	1.1,2.3.1,2.3.2,3.2.1,4.1.6
CO3	TPS3	Apply	Value	Mechanisms	1.1.1,2.3.2,2.4.4,2.4.7,3.2.1,4.3.4,4.4.5
CO4	TPS2	Understand	Response	Guided Response	1.1,2.3.1,2.3.2,3.2.1,4.1.6

Mapping with Programme Outcomes and Programme Specific Outcomes

Cos	PO1	PO2	PO3	PO4	PO5	PO6	PO7	PO8	PO9	PO10	PO11	PO12	PSO1	PSO2
CO 1	M	L	-	-	---	M	S	M	---	S	L	L	---	L
CO 2	M	L	-	-	---	---	S	M	---	S	---	---	---	L
CO 3	S	M	-	-	---	---	---	---	---	---	---	---	---	L
CO 4	M	L	-	-	---	M	S	M	---	S	---	---	---	L

S- Strong; M-Medium; L-Low

Assessment Pattern: Cognitive Domain

Cognitive Levels	Terminal Examination
Remember	20
Understand	40
Apply	40
Analyze	0
Evaluate	0
Create	0

Assessment Pattern: Psychomotor

Psychomotor Skill	Miniproject/Assignment/Practical Component
Perception	
Set	
Guided Response	
Mechanism	
Complex Overt Responses	
Adaptation	
Origination	

Sample Questions for Course Outcome Assessment**

** (2 to 3 at the cognitive level of course outcome)

Course Outcome1(CO1):

1. Define Systems?
2. Distinguish Boolean algebra and Conventional Martix
3. List the steps involved in value system design.

Course Outcome2(CO2):

1. Compare System and organism.
2. Discuss various components of System.

Course Outcome3(CO3):

1. Narrate any technology that interacts with society environment.
2. Identify the various needs to combat the educational challenges in India.
3. Draw the intent structures for education and energy supply.

Concept Map

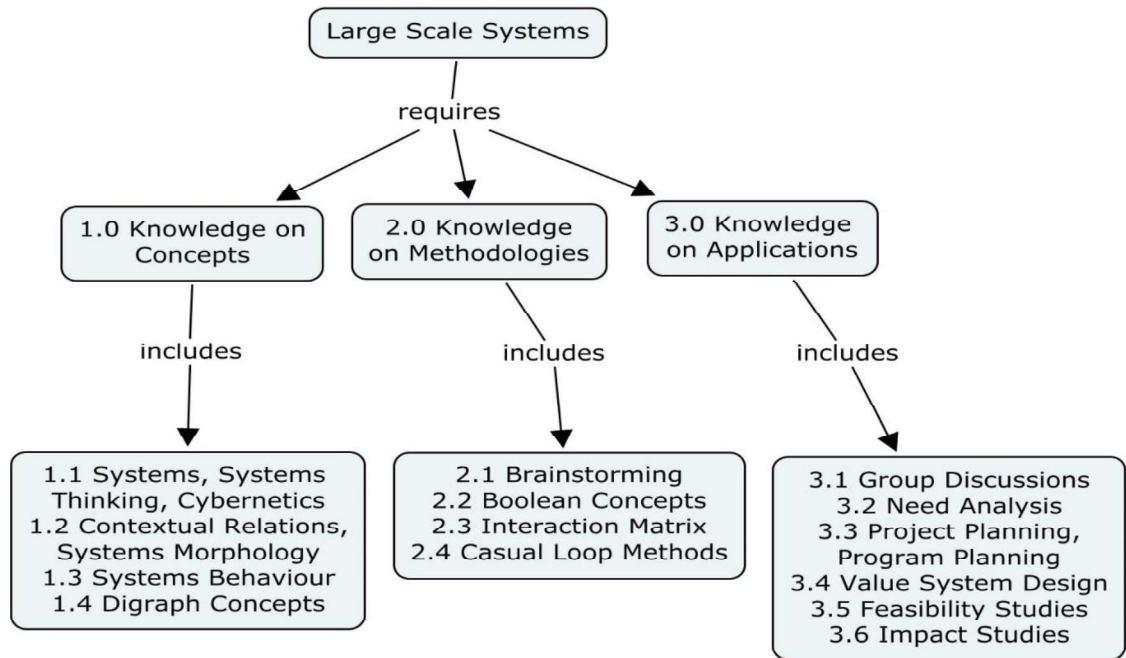

Syllabus

Systems thinking: Introduction, Problem Situation, Systems & Cybernetics, System Models, Hard/Soft Systems, Soft Systems Methodology, Soft System Examples/Case studies, Ashby's Requisite Variety Theory. **Systems Methodology and Planning:** Halls Morphological Box, Seven Phases of System Engineering, Seven Steps of System Engineering, Program Planning Linkage, Goals, Objectives, Constraints, Alterable, Measures etc., Example: Energy Supply and Demand, Value System Synthesis and Linkage. **Technology Forecasting and Assessment:** Philosophical Basis for TA/TF, Limits to growth model, Methodology in TATF- Brainstorming, Delphi, Relevance Tree Techniques, System Dynamics- Examples. **Theory of Constraints:** Fundamental Principles of the theory of Constraints, Understanding and Managing Constraints.

Learning Resources

1. Warfield, J. N. "An Introduction to Systems Science", World Scientific, Singapore, 2006.
2. Andrew P. Sage, "Methodology for Large-Scale Systems", McGraw Hill Publication, 1977

Course Contents and Lecture Schedule

Module No.	Topics	No. of Hours	CO
1.0	Knowledge on Concepts		
1.1	Systems, Systems Thinking, Cybernetics	1	CO1
1.2	Contextual Relations, Systems Morphology	1	CO1
1.3	Systems Behaviour	1	CO1
1.4	Digraph Concepts	1	CO1
2.0	Knowledge of Methodologies		
2.1	Brain storming	1	CO2
2.2	Boolean Concepts	1	CO2
2.3	Interaction Matrix	1	CO2
2.4	Casual Loop Methods	1	CO2
3.0	Knowledge of Applications		
3.1	Group Discussions	1	CO3
3.2	Need Analysis	1	CO3

3.3	Project Planning, Program Planning	1	CO3
3.4	Value System Design	1	CO4
3.5	Feasibility Studies	1	CO4
3.6	Impact Studies	1	CO4
Total Periods		14	

Course Designers:

1. Er. S. Ratnavel, CEO, Sceba Consultancy Services, Madurai

ratsiit@gmail.com

18CE1F0	INTERIOR DESIGN
----------------	------------------------

Category	L	T	P	Credit
PE	1	0	0	1

Preamble**Prerequisite****Course Outcomes**

On the successful completion of the course students will be able to

CO Number	Course Outcome Statement	Weightage*** in %
CO1	Explain concepts of interior design	20
CO2	Design interiors for corporate office, retail shops, residential buildings, hospitality sector, hotels, hospitals - Commercial Interiors - Auditoriums	20
CO3	Choose different materials - Color scheme - Lighting for outward looks	20
CO4	Design inside stuff of interiors: services namely Electrical - HVAC - Networking - Security systems.	20
CO5	Explain the importance of Project management and costing of interior.	20

*** Weightage depends on Bloom's Level, number of contact hours,

CO Mapping with CDIO Curriculum Framework

CO #	TCE Proficiency Scale	Learning Domain Level			CDIO Curricular Components (X.Y.Z)
		Cognitive	Affective	Psychomotor	
CO1	TSP2	Understand	Response	Guided Response	1.1,2.3.1,2.3.2,3.2.1,4.1.6
CO2	TPS2	Understand	Response	Guided Response	1.1,2.3.1,2.3.2,3.2.1,4.1.6
CO3	TPS3	Apply	Value	Mechanisms	1.1.1,2.3.2,2.4.4,2.4.7,3.2.1,4.3.4,4.4.5
CO4	TPS3	Apply	Value	Mechanisms	1.1.1,2.3.2,2.4.4,2.4.7,3.2.1,4.3.4,4.4.5
CO5	TPS3	Apply	Value	Mechanisms	1.1.1,2.3.2,2.4.4,2.4.7,3.2.1,4.3.4,4.4.5

Mapping with Programme Outcomes and Programme Specific Outcomes

Cos	PO1	PO2	PO3	PO4	PO5	PO6	PO7	PO8	PO9	PO10	PO11	PO12	PSO1	PSO2
CO 1	M	L	-	-	-	-	-	-	-	L	M	-	L	L
CO 2	M	L	-	-	-	M	-	-	M	-	L	-	L	L
CO 3	S	M	-	-	-	M	-	-	L	-	L	-	L	L
CO 4	S	M	-	-	-	M	-	-	L	-	L	-	L	L
CO 5	S	M	-	-	M	-	-	-	L	M	-	M	L	L

S- Strong; M-Medium; L-Low

Assessment Pattern: Cognitive Domain

Cognitive Levels	Continuous Assessment Tests	Terminal Examination
	1	
Remember	10	10
Understand	50	40
Apply	40	50
Analyze	--	--
Evaluate	--	--
Create	--	--

Assessment Pattern: Psychomotor

Psychomotor Skill	Miniproject/Assignment/Practical Component
Perception	
Set	
Guided Response	
Mechanism	
Complex Overt Responses	
Adaptation	
Origination	

Sample Questions for Course Outcome Assessment**

** (2 to 3 at the cognitive level of course outcome)

Course Outcome1(CO1):

1. Explain the types of walls in interiors
2. Explain the meaning of formal and informal design of walls
3. Define the terms: hardscape and softscape. Explain with examples

Course Outcome2(CO2):

1. Define Ergonomics and mention its need in corporate offices
2. Explain types of plants that can be used for interior decoration
3. Make use of interior concept, design the interior wall, floor and ceiling for a conference hall in an office of size 8m x10m. The ceiling height is 4m and a beam of 45cm depth runs through the shorter span at 3m intervals. Assume the window positions and sizes. Show the construction detail of the interior elements through proper sections

Course Outcome3(CO3):

1. What is the difference between a particle board and plywood
2. Explain the different types of walls and classify it based on its material and application in interior design.
3. Explain the different types of floors and classify it based on its material and application in interior design.

Course Outcome 4 (CO4):

1. Illustrate the interior layout with proper space planning and lighting design for an art gallery of size 10m x 12m and height 4m. Specify the colour, texture and finishes of the wall, floor and ceiling

2. Demonstrate the design of a wall mural as a background for the reception area of five star hotel lobby of size 10m x 10m and height 6m, applying the principles the interior design. Assume the necessary details. Specify and illustrate the materials and concept of your mural.
3. Explain the differences between halogen lamps and fluorescent lamps

Course Outcome 5 (CO5):

1. What is the need for knowledge on project management in interior design
2. What are the softwares to be used for interior designing and project management
3. Discuss the role of consultants in interior design

Concept Map

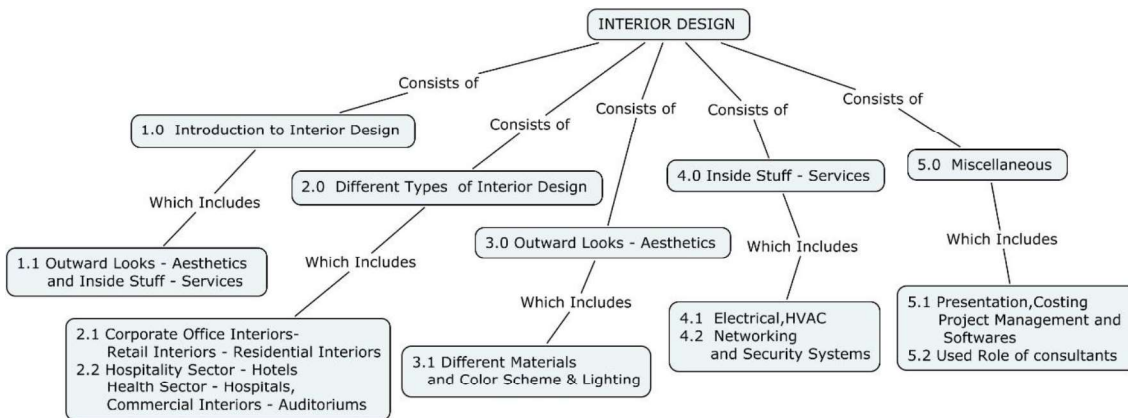

Syllabus

Introduction to interior design: Outward looks - Aesthetics - Inside stuff - Services. **Different types of Interiors:** Corporate office interiors - Retail interiors - Residential interiors - Hospitality sector – Hotels - Health sector - Hospitals - Commercial interiors - Auditoriums etc. **Outward Looks and Aesthetics:** Different Materials - Color scheme - Lighting. **Inside Stuff and Services:** Electrical - HVAC - Networking - Security systems. **Miscellaneous:** Presentation - Project Management and Costing - Softwares used - Role of consultants.

Learning Resources

1. . Mr. Immanuel B Samuel, Principal Architect Chris Brown Architects, Bangalore sam@cbarchitects.in

Course Contents and Lecture Schedule

Module No.	Topics	No. of Lectures	CO
1.0	Introduction to interior design		
1.1	Outward Looks - Aesthetics - Inside Stuff – Services	2	CO1
2.0	Different types of interiors		
2.1	Corporate Office Interiors- Retail Interiors - Residential	2	CO2
2.2	Hospitality Sector – Hotels- Health Sector – Hospitals- Commercial Interiors Auditoriums etc.	2	CO2
3.0	Outward looks and Aesthetics		
3.1	Different materials - Color scheme - Lighting	2	CO3
4.0	Inside stuff and Services		
4.1	Electrical - HVAC	2	CO4

Module No.	Topics	No. of Lectures	CO
4.2	Networking - Security Systems	1	CO4
5.0	Miscellaneous topic related to Interior design		
5.1	Presentation - Project Management and Costing	2	CO5
5.2	Softwares used - Role of consultants	1	CO5
Total hours		14 Hrs	

Course Designers:

1. Mr. Immanuel B Samuel, Principal Architect Chris Brown Architects,
Bangalore sam@cbarchitects.in

18CE1G0	FORENSIC GEOTECHNICAL ENGINEERING				
	Category	L	T	P	Credit
	PE	1	0	0	1

Preamble

This course will create awareness on geotechnical failures, causes, remedies and rehabilitation procedures.

Prerequisite

Knowledge on foundation failures

Course Outcomes

On the successful completion of the course students will be able to

CO Number	Course Outcome Statement	Weightage*** in %
CO1	Understand the importance of site investigation and soil testing	15
CO2	Check the vulnerability of soils and understand the problems associated with expansive soils	20
CO3	Predict settlement related problems- immediate and consolidation settlement	15
CO4	Suggest appropriate ground improvement techniques	25
CO5	Recommend appropriate underpinning methods	25

*** Weightage depends on Bloom's Level, number of contact hours,

CO Mapping with CDIO Curriculum Framework

CO #	TCE Proficiency Scale	Learning Domain Level			CDIO Curricular Components (X.Y.Z)
		Cognitive	Affective	Psychomotor	
CO1	TPS2	Understand	Respond	Guided Response	1.1.1,1.1.2,1.2.2,1.1,2.1.3,2.1.5,2.4.2, 2.4.6,3.1.1,3.1.2,4.1.1,4.1.2,4.3.4
CO2	TPS2	Understand	Respond	Guided Response	1.1.1,1.1.2,1.2.2,1.1,2.1.3,2.1.5,2.4.2, 2.4.6, 3.1.1,3.1.2,4.1.1,4.1.2,4.3.4
CO3	TPS3	Apply	Value	Mechanism	1.1.1,1.1.2,1.2.2,1.1,2.1.3,2.1.5,2.4.2, 2.4.6, 3.1.1,3.1.2,4.1.1,4.1.2,4.3.4
CO4	TPS3	Apply	Value	Mechanism	1.1.1,1.1.2,1.2.2,1.1,2.1.3,2.1.5,2.4.2, 2.4.6,3.1.1,3.1.2,4.1.1,4.1.2,4.3.4
CO5	TPS3	Apply	Value	Mechanism	1.1.1,1.1.2,1.2.2,1.1,2.1.3,2.1.5,2.4.2, 2.4.6,3.1.1,3.1.2,4.1.1,4.1.2,4.3.4

Mapping with Programme Outcomes and Programme Specific Outcomes

Cos	PO1	PO2	PO3	PO4	PO5	PO6	PO7	PO8	PO9	PO10	PO11	PO12	PSO1	PSO2
CO 1	M	L	-	-	-	L	L	M	M	M	L	L	L	L
CO 2	M	L	-	-	-	L	L	M	M	M	L	L	L	L
CO 3	S	M	L	-	-	M	M	S	S	S	L	M	M	M
CO 4	S	M	L	-	-	M	M	S	S	S	L	M	M	M
CO	S	M	L	-	-	M	M	S	S	S	L	M	M	M

5																			
---	--	--	--	--	--	--	--	--	--	--	--	--	--	--	--	--	--	--	--

S- Strong; M-Medium; L-Low

Assessment Pattern: Cognitive Domain

Cognitive Levels	Continuous Assessment Tests	Terminal Examination
	1	
Remember	10	10
Understand	30	30
Apply	40	40
Analyse	-	-
Evaluate	-	-
Create	-	-

Assessment Pattern: Psychomotor

Psychomotor Skill	Miniproject/Assignment/Practical Component
Perception	-
Set	-
Guided Response	-
Mechanism	-
Complex Overt Responses	-
Adaptation	-
Origination	-

Sample Questions for Course Outcome Assessment**

** (2 to 3 at the cognitive level of course outcome)

Course Outcome1(CO1):

1. Mention the importance of subsoil exploration.
2. Explain the different field tests in geotechnical investigation.
3. What are all the lab tests in geotechnical investigation?

Course Outcome2(CO2):

1. Define expansive soil.
2. How expansive soils affect the structure?
3. Discuss about the water fluctuation and soil strength vulnerability.

Course Outcome3(CO3):

1. Define elastic or immediate settlement.
2. Discuss in detail about consolidation settlement.
3. What are all the factors affecting consolidation?

Course Outcome 4 (CO4):

1. Why ground improvement studies are important for civil engineers?
2. Discuss about various lime treatments.
3. Discuss the grouting process.

Course Outcome 5 (CO5):

1. Define and discuss underpinning and shoring.
2. How to improve the bearing capacity of soil bellow existing foundation?
3. Discuss about the micro piles and applications.

Concept Map

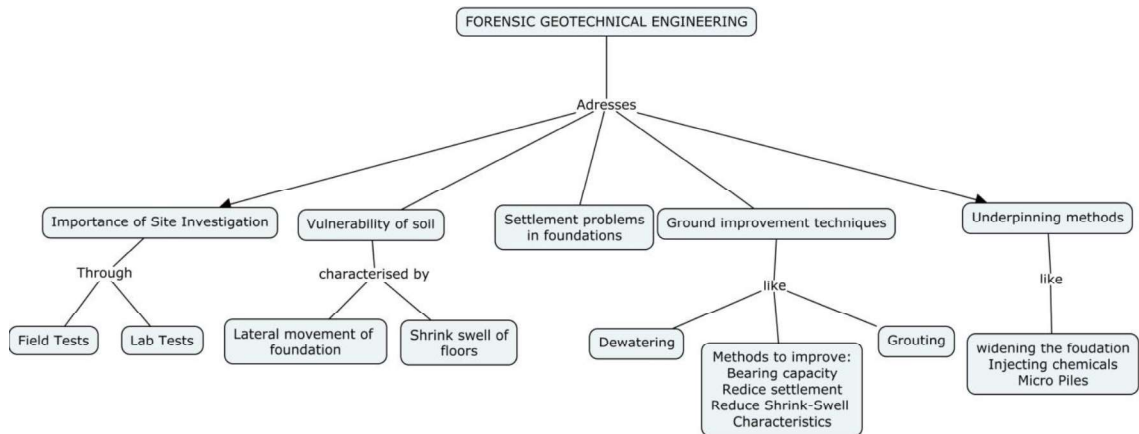

Syllabus

Importance of Site Investigation: Field tests - Lab tests **Soil vulnerability and Expansive Soils:** Atterberg's limits - Swell shrink behaviour - Lateral movement of foundation - Swell shrink of floors - **Settlement problems:** Elastic / immediate settlement - Consolidation settlement **Ground improvement techniques:** De-watering techniques - Methods to improve bearing capacity - Methods to alter swell shrink behaviour - Methods to reduce settlement - Grouting equipments and applications **Underpinning methods:** Increase the size of foundation - Additional Foundation with existing foundation - Injection of chemicals below the existing foundation - Micro piles and their applications – Case studies on underpinning of shallow and deep foundations, rehabilitation of earth retaining structures

Learning Resources

1. M.J. Tomlinson, "Foundation Design and Construction", 5th Edition, ELBS, 1996.
2. V.N.S Moorthy, "Advanced Foundation Engineering", CBS Publishers, New Delhi, 2017.
3. Winterkorn and Fang, "Foundation Engineering Handbook", GalgotiaBooksSource, 2010.

Course Contents and Lecture Schedule

Module No.	Topic	No. of Hours	Course Outcome
1.	Importance of Site Investigation		
1.1	Field tests	1	CO1
1.2	Lab tests	1	
2.	Soil vulnerability and Expansive Soils		
2.1	Atterberg's limits - Swell shrink behaviour	1	CO2
2.2	Lateral movement of foundation - Swell shrink of floors	1	
3.	Settlement problems		
3.1	Elastic / immediate settlement	1	CO3
3.2	Consolidation settlement	1	
4.	Ground improvement techniques		
4.1	De-watering techniques	1	CO4
4.2	Methods to improve bearing capacity- Methods to alter swell shrink behaviour - Methods to reduce settlement	1	
4.3	Grouting equipments and applications	1	
5.	Underpinning methods		
5.1	Increase the size of foundation - Additional Foundation with existing foundation	1	CO5
5.2	Injection of chemicals below the existing foundation - Micro piles and their applications	1	
5.3	Case studies on underpinning of shallow and deep foundations - Rehabilitation of earth retaining	1	

		Category	L	T	P	Credit
		PE	1	0	0	1
structures						
		Total Hours			12	

Course Designers:

1. Er. A. Karthikeyan

karthikeyanassociates@gmail.com

18CE1H0	FECAL SLUDGE MANAGEMENT
----------------	--------------------------------

Preamble

This course deals with an introduction about FSM, an overview of the systems level approach for implementation & operation and some of the unique challenges of FSM

Prerequisite

NIL

Course Outcomes

On the successful completion of the course students will be able to

CO Number	Course Outcome Statement	Weightage*** in %
CO1	Ability to understand the impacts of improper sanitation on public health, environment and economy	25
CO2	Gain an understanding of fundamental concepts and principles of urban sanitation and specifically Fecal Sludge Management (FSM) and various elements in the sanitation chain	25
CO3	To develop a basic understanding of different technological options (along the full cycle of sanitation)	25
CO4	Ability to define the conditions under which sanitation solutions need to be implemented for sustainability	25

*** Weightage depends on Bloom's Level, number of contact hours,

CO Mapping with CDIO Curriculum Framework

CO #	TCE Proficiency Scale	Learning Domain Level			CDIO Curricular Components (X.Y.Z)
		Cognitive	Affective	Psychomotor	
CO1	TPS2	Understand	Response	Guided Response	1.1,2.3.1,2.3.2,3.2.1,4.1.6
CO2	TPS2	Understand	Response	Guided Response	1.1,2.3.1,2.3.2,3.2.1,4.1.6
CO3	TPS3	Apply	Value	Mechanisms	1.1.1,2.3.2,2.4.4,2.4.7,3.2.1,4.3.4,4.4.5

CO4	TPS3	Apply	Value	Mechanisms	1.1.1,2.3.2,2.4.4,2.4.7,3.2.1,4.3.4,4.4.5
-----	------	-------	-------	------------	---

Mapping with Programme Outcomes and Programme Specific Outcomes

Cos	PO1	PO2	PO3	PO4	PO5	PO6	PO7	PO8	PO9	PO10	PO11	PO12	PSO1	PSO2
CO 1	M	L	-	-	-	-	M	L	-	S	-	-	M	-
CO 2	M	L	-	-	-	-	-	-	-	S	-	-	M	-
CO 3	S	M	-	-	-	-	M	-	L	S	M	-	S	--
CO 4	S	M	-	-	-	-	-	-	L	S	M	-	S	-

S- Strong; M-Medium; L-Low

Assessment Pattern: Cognitive Domain

Cognitive Levels	Continuous Assessment Tests	Terminal Examination
	1	
Remember	10	10
Understand	50	40
Apply	40	50
Analyze		
Evaluate		
Create		

Assessment Pattern: Psychomotor

Psychomotor Skill	Miniproject/Assignment/Practical Component
Perception	
Set	
Guided Response	
Mechanism	
Complex Overt Responses	
Adaptation	
Origination	

Sample Questions for Course Outcome Assessment**

** (2 to 3 at the cognitive level of course outcome)

Course Outcome1(CO1):

1. Define Faecal Sludge management
2. List the effects of improper sanitation
3. What is the global and national situation of on-site sanitation?

Course Outcome2(CO2):

1. What should be considered when designing a financing scheme for sanitation systems?
2. What are the main characteristics of FS and what parameters are used to describe them?
3. Methods and Means for Collection and Transport of Faecal Sludge

Course Outcome3(CO3):

1. What are the effluent standards for FS treatment plants?
2. What are the main processing steps in FSM?
3. What are the major technologies for solid-liquid separation and FS treatment?

Course Outcome 4 (CO4):

1. Who are the stakeholders in faecal sludge management and what are their roles and challenges?
2. Write the importance of composting as form of sludge management in FSM

3. Draw the functional framework for sustainable solution of FSM

Concept

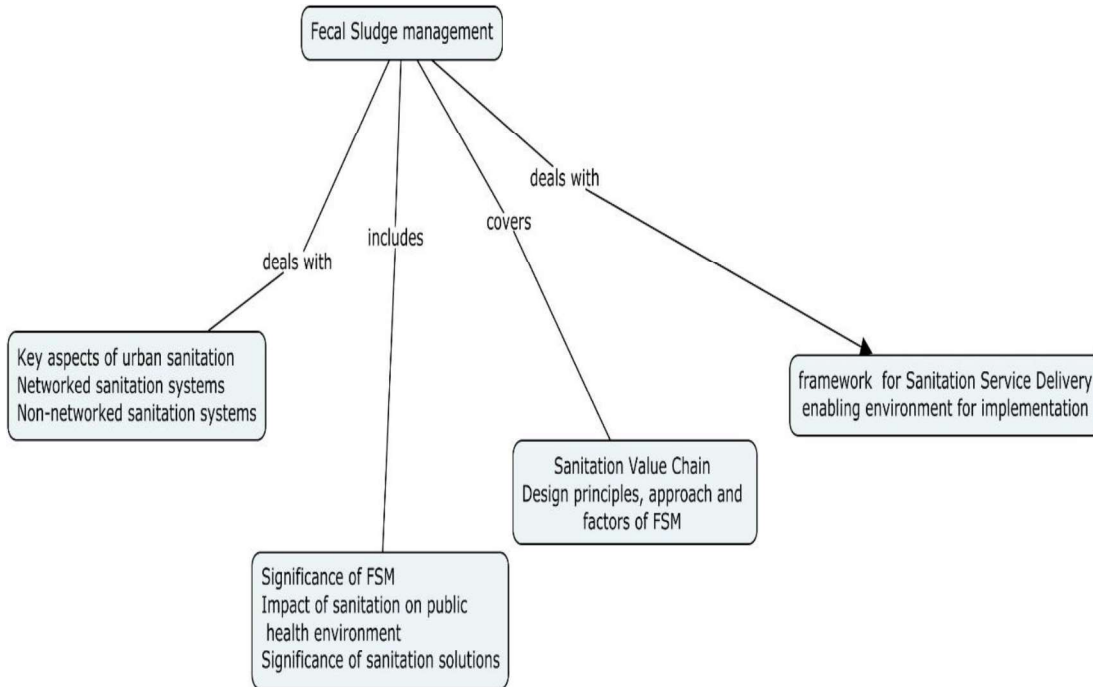

Syllabus

Key aspects of urban sanitation situation in India (current sanitation situation, problems and challenges) – Networked and non-networked sanitation systems; Significance of FSM; Impact of sanitation on public health environment and economy (importance/Significance of sanitation solutions); Understanding the Sanitation Value Chain and Appropriate sanitation solutions and Design principles, approach and factors (what solution would work in different situations and why); Implementation framework for Sanitation Service Delivery and understanding enabling environment for implementation

Learning Resources

1. Mara, D., Lane, J., Scott, B., and Trouba, D. (2010), Sanitation and Health. PLoS Medicine policy forum, Vol 7, Issue 11, Pg 1-7, e1000363. (doi: 10.1371/journal.pmed.1000363).
2. Wankhade, K., Balakrishnan, K., and Vishnu, M. J. (2014), Urban water supply and sanitation in India: sustaining policy momentum (IIHS-RF paper on urban water and sanitation in India), Pg 1-72.
3. Strande, L., Ronteltap, M., and Brdjanovic, D. (2014), Fecal Sludge Management: Systems Approach for Implementation and Operation, IWA Publishing.
4. Kevin Tayler (2018), Fecal Sludge and Septage Treatment: A guide for low- and middle-income countries, Practical action publishing.
5. Wankhade, K (2016), Operationalising SDG 6 in Urban India, IIHS Bangalore, Pg 83-94.

Course Contents and Lecture Schedule

Module No.	Topic	No. of Hours	Course Outcome
1.0	Key aspects of urban sanitation situation in India	1	CO1
1.1	Networked sanitation systems	1	CO1
1.2	Non-networked sanitation systems	1	CO1
2.0	Significance of FSM	1	CO2
2.1	Impact of sanitation on public health environment and	2	CO2

	economy		
2.2	Significance of sanitation solutions	1	CO2
3.1	Understanding the Sanitation Value Chain and Appropriate sanitation solutions	2	CO3
3.2	Design principles, approach and factors of FSM and solutioning in different situations	3	CO3
4.1	Implementation framework for Sanitation Service Delivery	1	CO4
4.2	Understanding enabling environment for implementation	1	CO4
	Total	14 hours	

Course Designers:

- 1.Ms.Molly Grace Indian Institute for Human settlements mollyg@iihs.ac.in
2.Dr. Suneethi Sundar, Indian Institute for Human settlements ssundar@iihs.ac.in

18CEGA0	SUSTAINABLE DEVELOPMENT				
	Category	L	T	P	Credit
	GE	3	0	0	3

Preamble

This coursework exposes the students to the complex relationships between social, economical and environmental processes

Prerequisite

NIL

Course Outcomes

On the successful completion of the course students will be able to

CO Number	Course Outcome Statement	Weightage*** in %
CO1	Understand the basic idea on core competencies in Sustainable Development	15
CO2	Understand the International protocols and commitments towards Sustainability	15
CO3	Build an interdisciplinary perspective on Sustainable Development and learn the challenges, concerns and Responses	20
CO4	Learn and measure the sustainability through performance indicators	10
CO5	Familiarize with current debates on opportunities for Sustainable Development and analyse its relevance in various sectors	20
CO6	Explore and develop the strategies to achieve Sustainable Development in Indian context	20

*** Weightage depends on Bloom's Level, number of contact hours.

CO Mapping with CDIO Curriculum Framework

CO	TCE Proficiency Scale	Learning Domain Level			CDIO Curricular Components (X.Y.Z)
		Cognitive	Affective	Psychomotor	
CO1	TPS2	Understand	Respond	Guided Response	1.1,1.2,2.3.1,2.3.2,2.4.4,&3.2.1
CO2	TPS2	Understand	Respond	Guided Response	1.1,1.2,2.3.1,2.3.2,2.4.4,&3.2.1
CO3	TPS3	Apply	Value	Mechanism	1.1,1.2,2.3.1,2.3.2,2.4.4,3.2.1,4.1,4.4.1&4.4.5
CO4	TPS3	Apply	Value	Mechanism	1.1,1.2,2.3.1,2.3.2,2.4.4,3.2.1,4.1,4.4.1&4.4.5
CO5	TPS3	Apply	Value	Mechanism	1.1,1.2,2.3.1,2.3.2,2.4.4,3.2.1,4.1,4.4.1&4.4.5
CO6	TPS3	Apply	Value	Mechanism	1.1,1.2,2.3.1,2.3.2,2.4.4,3.2.1,4.1,4.4.1&4.4.5

Mapping with Programme Outcomes and Programme Specific Outcomes

Cos	PO1	PO2	PO3	PO4	PO5	PO6	PO7	PO8	PO9	PO10	PO11	PO12	PSO1	PSO2
-----	-----	-----	-----	-----	-----	-----	-----	-----	-----	------	------	------	------	------

CO 1	M	L	-	-	-	M	S	M	M	L	L	-	-	M
CO 2	M	L	-	-	-	L	S	M	M	M	L	M	-	M
CO 3	S	M	L	-	-	L	S	M	L	L	-	-	M	S
CO 4	S	M	L	-	-	L	S	L	L	L	-	-	M	S
CO 5	S	M	L	-	-	M	S	M	L	M	-	-	M	S
CO 6	S	M	L	-	-	M	S	M	M	M	-	M	M	S

S- Strong; M-Medium; L-Low

Assessment Pattern: Cognitive Domain

Cognitive Levels	Continuous Assessment Tests			Assignment			Terminal Examination
	1	2	3	1	2	3	
Remember	12	12	12	-	-	-	12
Understand	48	48	48	-	-	-	48
Apply	40	40	40	10	10	10	40
Analyse	-	-	-	-	-	-	-
Evaluate	-	-	-	-	-	-	-
Create	-	-	-	-	-	-	-

Assessment Pattern: Psychomotor

Psychomotor Skill	Mini project/Assignment/Practical Component
Perception	-
Set	-
Guided Response	50
Mechanism	50
Complex Overt Responses	-
Adaptation	-
Origination	-

Course Level Assessment Questions

Course Outcome 1(CO1)	
1.	Identify the linkages between Environment and Developmental activity.
2.	How will you link social sustainability to environmental and economic sectors?
3.	Trace the evolution of the concept of Sustainable Development.
Course Outcome 2(CO2)	
1.	Give an account of the international milestones in achieving goals of Sustainable Development.
2.	Discuss about the outcome of any two international summit of Sustainable Development.
Course Outcome 3(CO3)	
1.	Discuss the possibilities to achieve sustainability in agricultural sector.

2.	Identify the barriers to achieve sustainability in natural resources management especially in Developing nations.
Course Outcome 4(CO4)	
1.	How Sustainable Development can be assessed?
2.	Discuss about the indicators of a country's development.
3.	Illustrate the history of Commission on Sustainable Development indicators.
Course Outcome 5(CO5)	
1.	Enumerate the business-Industrial sector interaction in Sustainable Development
2.	Discuss in detail about the sustainable movements happened towards water resources management sector
Course Outcome 6(CO6)	
1.	Suggest measures to tackle the inflated temperature (predicted) for May 2019. Construct a strategic plan to prevent 1°C rise by 2100 (this includes plans to reclaim all the effects of climate change to a state of equilibrium).
2.	Considering the current world population, identify its emerging risks in 21 st century (with respect to population, technology and resources) and suggest few sustainable solutions (general framework) in overcoming them.

Concept Map

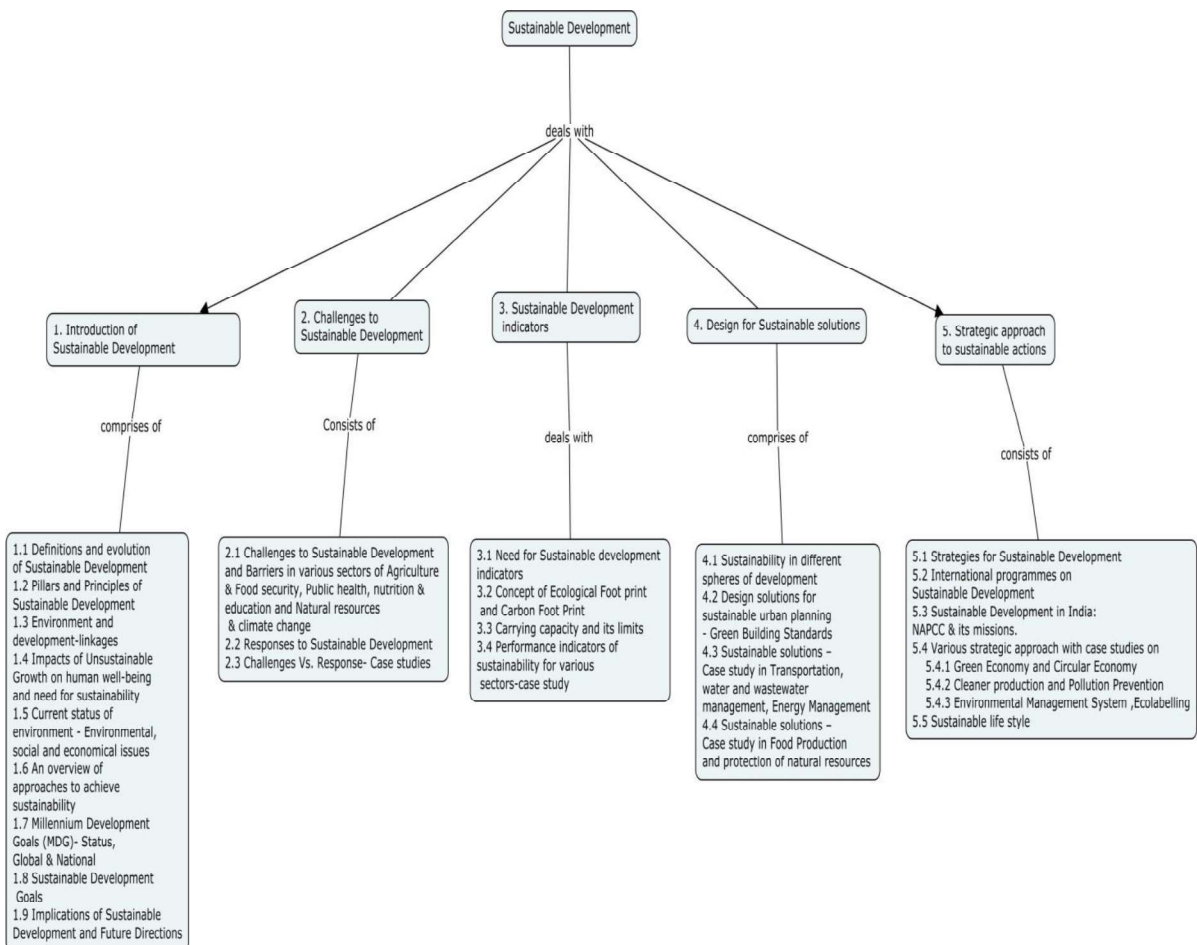

Syllabus

Introduction of Sustainable Development-Definitions, evolution, Pillars and Principles of

Sustainable Development-Environment and development linkages-Impacts of Unsustainable Growth on human wellbeing and need for sustainability-Current status of environment - Environmental, Social and Economic issues-An overview of approaches to achieve sustainability-Millennium Development Goals (MDG)- Sustainable Development Goals(SDG)-status of Implementation at National & Global level -Implications and Future Directions-**Challenges to Sustainable Development**-Challenges and Barriers in various sectors in the context of Climate Change, Responses to Sustainable Development-Challenges Vs. Response-Case studies. **Sustainable Development indicators**-Need for Sustainable Development indicators, Concept of Ecological Foot print and Carbon Foot Print, Carrying Capacity and its limits, Performance indicators of sustainability for various sectors. **Design for sustainable solutions**-Sustainability in different spheres of development, Design solutions for sustainable urban planning, Green Building Standards, Sustainable solutions-Case study in Transportation, Water and Wastewater management, Energy Management, Food Production, Resources and Life style. **Strategic approach to sustainable actions**-strategies for sustainable development, International programmes on Sustainable Development, Sustainable Development in India: NAPCC & its missions, Various strategic approach with case studies on-Green Economy and Circular Economy, Cleaner production and Pollution Prevention-Environmental Management System, Ecolabelling, and Sustainable life style.

Learning Resources

1. Kirkby, J., O'Keefe, P. and Timberlake, Sustainable Development, Earthscan Publication, London, 1993.
2. Low, N. Global ethics and environment. London: Routledge. 1999.
3. Sayer, J. and Campbell, B., The Science of Sustainable Development: Local Livelihoods and the Global Environment (Biological Conservation, Restoration & Sustainability), Cambridge University Press, London, 2003.
4. United Nations Indicators of Sustainable Development: Guidelines and Methodologies. New York: United Nations 2007.
5. UNEP, Towards a Green Economy: Pathways to Sustainable Development and Poverty Eradication, www.unep.org/greeneconomy, ISBN: 978-92-807-3143-9 ,2011.
6. World Bank "Inclusive Green Growth – The pathway to Sustainable Development, World Bank- Washington DC 2012.

Course Contents and Lecture Schedule

Module No.	Topic	No. of Hours	Course Outcome
1. INTRODUCTION OF SUSTAINABLE DEVELOPMENT			
1.1	Definitions and evolution of Sustainable Development	1	CO1
1.2	Pillars and Principles of Sustainable Development	1	CO1
1.3	Environment and development-linkages	1	CO1
1.4	Impacts of Unsustainable Growth on human well-being and need for sustainability	1	CO1
1.5	Current status of environment - Environmental, social and economical issues	1	CO1
1.6	An overview of approaches to achieve sustainability	1	CO1
1.7	Millennium Development Goals (MDG)- Status, Global & National	1	CO2
1.8	Sustainable Development Goals	1	CO2
1.9	Implications of Sustainable Development and Future Directions	1	CO2
2. CHALLENGES TO SUSTAINABLE DEVELOPMENT			

2.1	Challenges to Sustainable Development and Barriers in various sectors of Agriculture & Food security, Public health, nutrition & education and Natural resources & climate change	3	CO3
2.2	Responses to Sustainable Development	1	CO3
2.3	Challenges Vs. Response- Case studies	1	CO3
3.SUSTAINABLE DEVELOPMENT INDICATORS			
3.1	Need for Sustainable Development indicators	1	CO4
3.2	Concept of Ecological Foot print and Carbon Foot Print	2	CO4
3.3	Carrying capacity and its limits	1	CO4
3.4	Performance indicators of sustainability for various sectors-case study	2	CO4
4.DESIGN FOR SUSTAINABLE SOLUTIONS			
4.1	Sustainability in different spheres of development	1	CO5
4.2	Design solutions for sustainable urban planning - Green Building Standards	2	CO5
4.3	Sustainable solutions – Case study in Transportation, water and wastewater management, Energy Management	2	CO5
4.4	Sustainable solutions – Case study in Food Production and protection of natural resources	2	CO5
5.STRATEGIC APPROACH TO SUSTAINABLE ACTIONS			
5.1	Strategies for Sustainable Development	1	CO6
5.2	International programmes on Sustainable Development	2	CO2
5.3	Sustainable Development in India: NAPCC & its missions.	2	CO6
5.4	Various strategic approach with case studies on		
5.4.1	Green Economy and Circular Economy	1	C06
5.4.2	Cleaner Production and Pollution Prevention	1	CO6
5.4.3	Environmental Management System,Ecolabelling	1	CO6
5.5	Sustainable life style.	1	CO6
	Total	36 Hrs	

Course Designers:

1. Dr.S.Chandran schandran@tce.edu
2. Dr.V.Ravisankar environmentengr@tce.edu
3. Ms.K.Keerthy kkciv@tce.edu

18CEGB0	BUILDING SERVICES				
	Category	L	T	P	Credit
	GE	3	0	0	3

Preamble

This course work imparts knowledge required for understanding the general principles of building planning and services with the help of relevant codes, manuals and guidelines.

Prerequisite

NIL

Course Outcomes

On the successful completion of the course students will be able to

CO Number	Course Outcome Statement	Weightage*** in %
CO1	Understand the necessity of various types of services involved in buildings	15
CO2	Incorporate general planning considerations by relevant codes, manuals and hand books for buildings	15
CO3	Apply the principles of electrical and lighting services for different uses in buildings	20
CO4	Plan and design the requirements for HVAC system and firefighting installations	15
CO5	Design the drainage system and basic requirements of water supply and sanitation network within the building	20
CO6	Apply the principles of automation and integrated planning for the better usage of the building	15

*** Weightage depends on Bloom's Level, number of contact hours,

CO Mapping with CDIO Curriculum Framework

CO #	TCE Proficiency Scale	Learning Domain Level			CDIO Curricular Components (X.Y.Z)
		Cognitive	Affective	Psychomotor	
CO1	TPS2	Understand	Respond	Guided Response	1.2,2.3.1,2.5.1,3.2.1,4.3.1,4.3.2, 4.4.5.
CO2	TPS2	Understand	Respond	Guided Response	1.2,2.3.1,2.5.1,3.2.1,4.3.1,4.3.2, 4.4.5.
CO3	TPS3	Apply	Value	Mechanism	1.2,2.3.1,2.5.1,3.2.1,4.3.1,4.3.2, 4.4.5.
CO4	TPS3	Apply	Value	Mechanism	1.2,2.3.1,2.5.1,3.2.1,4.3.1,4.3.2, 4.4.5.
CO5	TPS3	Apply	Value	Mechanism	1.2,2.3.1,2.5.1,3.2.1,4.3.1,4.3.2, 4.4.5.
CO6	TPS3	Apply	Value	Mechanism	1.2,2.3.1,2.5.1,3.2.1,4.3.1,4.3.2, 4.4.5.

Mapping with Programme Outcomes and Programme Specific Outcomes

Cos	PO1	PO2	PO3	PO4	PO5	PO6	PO7	PO8	PO9	PO10	PO11	PO12	PSO1	PSO2
CO	M	L	-	-	-	-	M	M	-	M	L	L	-	-

1															
CO 2	M	L	-	-	-	-	M	M	L	L	-	-	M	L	
CO 3	S	M	L	-	-	-	L	L	-	L	-	-	M	L	
CO 4	S	M	L	-	L	-	L	L	-	L	-	-	M	L	
CO 5	S	M	L	-	L	-	L	L	-	L	-	-	M	L	
CO 6	S	M	L	-	L	-	L	L	-	L	-	-	M	L	

S- Strong; M-Medium; L-Low

Assessment Pattern: Cognitive Domain

Cognitive Levels	Continuous Assessment Tests			Assignment			Terminal Examination
	1	2	3	1	2	3	
Remember	12	12	12	-	-	-	12
Understand	48	48	48	-	-	-	48
Apply	40	40	40	10	10	10	40
Analyse	-	-	-	-	-	-	-
Evaluate	-	-	-	-	-	-	-
Create	-	-	-	-	-	-	-

Assessment Pattern: Psychomotor

Psychomotor Skill	Miniproject/Assignment/Practical Component
Perception	-
Set	-
Guided Response	50
Mechanism	50
Complex Overt Responses	-
Adaptation	-
Origionation	-

Sample Questions for Course Outcome Assessment**

** (2 to 3 at the cognitive level of course outcome)

Course Outcome1(CO1):

1. Discuss the Strategies and practices you will follow to build your own house as Green Building.
2. Discuss the need of rain water harvesting system in a building.

Course Outcome2(CO2):

1. Discuss the planning considerations to be made in buildings based on codal provisions on fire safety
2. Assume an IT building is to be constructed in a metropolitan area of 20,000 sq.m. The width of road in front is 15 m. Plan the building according to F.S.I and height restrictions. Justify your recommendations.

Course Outcome3(CO3):

1. Plan and draw an electrical layout for a residential building considering the essential electrical points in various rooms
2. Specify the minimum levels of illumination for different buildings as per NBC

Course Outcome 4 (CO4):

1. Suggest suitable fire-fighting installations needed for a commercial complex building of 4 floors.
2. Select a suitable wiring system for a building having a connected load of 500kW. Make suitable assumptions. Justify your selection.

Course Outcome 5 (CO5):

1. Explain about the different systems of plumbing installed in buildings.
2. Based on the water Resources available in your area of living, construct the flowchart for the treatment of water to fit for Drinking purpose.

Course Outcome6(CO6):

1. Discuss the necessity of kinetic systems in buildings.
2. Write short notes on human machine interface and intelligence systems.

Concept Map

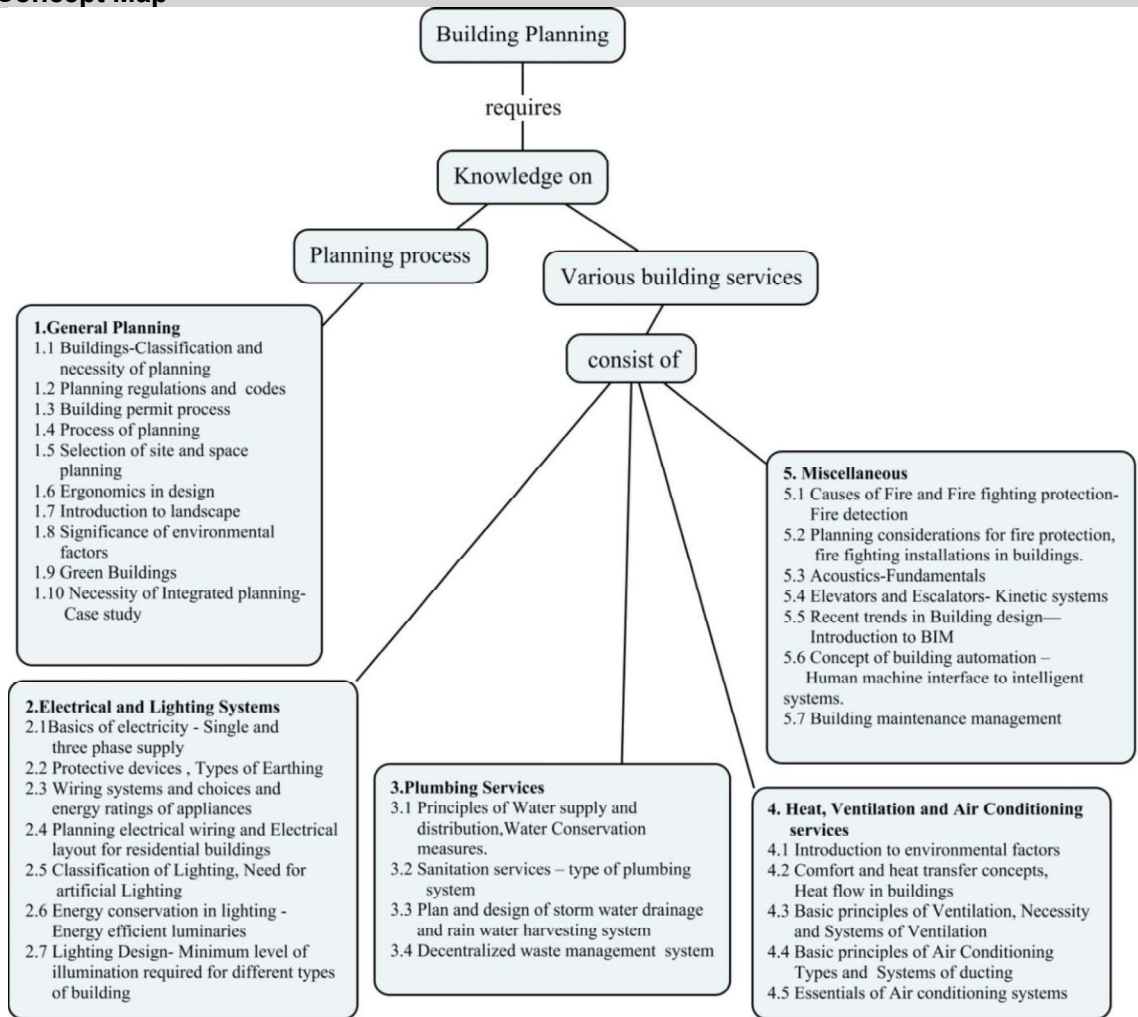

Syllabus

General Planning:—Buildings-Classification and necessity of planning-Planning regulations and relevant codes- Building permit process- Process of planning- Selection of site and space planning - Ergonomics in design- Introduction to landscape- Significance of environmental factors- Green Buildings - Necessity of Integrated planning-Case study. **Electrical and Lighting Systems:**Basics of electricity - Single and three phase supply- Protective devices, Types of Earthing- Wiring systems and choices and energy ratings of appliances- Planning electrical

wiring and Electrical layout for residential buildings - Classification of Lighting, Need for artificial Lighting - Energy conservation in lighting - Energy efficient luminaries - Lighting Design- Minimum level of illumination required for different types of building. **Plumbing Services:** Principles of Water supply and distribution, Water Conservation measures-Sanitation services – type of plumbing system - Plan and design of storm water drainage and rain water harvesting system - Decentralized waste management system –wastewater and solid waste **Heating, Ventilation and Air Conditioning services:** Introduction to environmental factors - Comfort and heat transfer concepts, Heat flow in buildings-Basic principles of Ventilation, Necessity and Systems of Ventilation- Basic principles of Air Conditioning – Types and Systems of ducting, Essentials of Air conditioning systems. **Miscellaneous** - Causes of Fire and Fire fighting protection- Fire detection - Planning considerations for fire protection, fire fighting installations in buildings - Acoustics-Fundamentals - Elevators and Escalators- Kinetic systems, Recent trends in Building design—Introduction to BIM, Concept of building automation – Human machine interface & intelligent systems, Building maintenance management

Learning Resources

1. National Building Code of India -2016
2. Development Control Rules by Chennai Metropolitan Development Agency - 2006
3. Energy Conservation Building Code – 2007
4. CPHEEO Manual on Sewerage and sewage treatment systems – 2013
5. Manual for environmental clearance for large construction projects – by Ministry of environment, forest and climate change.

Course Contents and Lecture Schedule

Module No.	Topic	No. of Lectures	Course outcomes
1.0	General Planning		
1.1	Buildings-Classification and necessity of planning	1	CO1
1.2	Planning regulations and relevant codes	2	CO2
1.3	Building permit process	1	CO2
1.4	Process of planning	1	CO1
1.5	Selection of site and space planning	1	CO2
1.6	Ergonomics in design	1	CO1
1.7	Introduction to landscape	1	CO1
1.8	Significance of environmental factors	1	CO1
1.9	Green Buildings	1	CO2
1.10	Necessity of Integrated planning-Case study	2	CO6
2.0	Electrical and Lighting Systems		
2.1	Basics of electricity - Single and three phase supply	1	CO3
2.2	Protective devices , Types of Earthing	1	CO3
2.3	Wiring systems and choices and energy ratings of appliances	1	CO3
2.4	Planning electrical wiring and Electrical layout for residential buildings	1	CO3
2.5	Classification of Lighting, Need for artificial Lighting	1	CO3
2.6	Energy conservation in lighting - Energy efficient luminaries	1	CO3
2.7	Lighting Design- Minimum level of illumination required for different types of building	1	CO3
3.0	Plumbing Services		

3.1	Principles of Water supply and distribution, Water Conservation measures.	2	CO5
3.2	Sanitation services – type of plumbing system	1	CO5
3.3	Plan and design of storm water drainage and rain water harvesting system	2	CO5
3.4	Decentralized waste managementsystem – wastewater and solid waste.	1	CO5
4.0	Heating, Ventilation and Air Conditioning services		
4.1	Comfort and heat transfer concepts, Heat flow in buildings	1	CO4
4.2	Basic principles of Ventilation, Necessity and Systems of Ventilation	1	CO4
4.3	Basic principles of Air Conditioning – Types and Systems of ducting	1	CO4
4.4	Essentials of Air conditioning systems	1	CO4
5.0	Miscellaneous		
5.1	Causes of Fire and Fire fighting protection- Fire detection	1	CO4
5.2	Planning considerations for fire protection, fire fighting installations in buildings.	1	CO4
5.3	Acoustics-Fundamentals	1	CO1
5.4	Kinetic systems -Elevators and Escalators.	1	CO6
5.5	Recent trends in Building design & Introduction to BIM	1	CO6
5.6	Concept of building automation – Human machine interface and intelligent systems.	1	CO6
5.7	Building maintenance management	1	CO6
	TOTAL	36	

Course Designers:

1. Dr.G.Chitra gcciv@tce.edu
2. Dr.V. Ravisankar environmentengr@tce.edu
3. D. Rajkumar rajkumarcivil@tce.edu

18CEGC0	DISASTER ASSESSMENT AND MITIGATION MEASURES
----------------	--

Category	L	T	P	Credit
GE	3	0	0	3

Preamble

This course deals with the various disasters and their effects against built structures, and Hazard Assessment procedure in India. This course also deals with the methods of mitigating various hazards such that their risk and impact on communities is reduced.

Prerequisite

NIL

Course

Outcomes

On the successful completion of the course students will be able to

CO Number	Course Outcome Statement	Weightage*** in %
CO1	Understand the various types of manmade and natural hazards and disaster	10
CO2	apply the disaster resistant principle to the deficient buildings against natural disaster	30
CO3	apply the risk reduction technique involved in manmade disaster	30
CO4	Apply the vulnerability reduction technique adopted by NDRF, State and local bodies	10
CO5	Apply the hazard assessment procedure to the existing buildings	10
CO6	Apply the alternative communication technique during the disaster	10

*** Weightage depends on Bloom's Level, number of contact hours,

CO Mapping with CDIO Curriculum Framework

CO #	TCE Proficiency Scale	Learning Domain Level			CDIO Curricular Components (X.Y.Z)
		Cognitive	Affective	Psychomotor	
CO1	TPS2	Understand	Respond	Guided Response	1.2,2.1.1
CO2	TPS3	Apply	Value	Mechanism	1.1.1, 1.2, 1.3, 2.1.3, 2.1.4, 2.1.5, 4.4.1, 4.4.2, 4.4.3
CO3	TPS3	Apply	Value	Mechanism	1.1.1, 1.2, 1.3, 2.1.3, 2.1.4, 2.1.5, 4.4.1, 4.4.2, 4.4.3
CO4	TPS3	Apply	Value	Mechanism	1.1.1, 1.2, 1.3, 2.1.3, 2.1.4, 2.1.5, 4.4.1, 4.4.2, 4.4.3
CO5	TPS3	Apply	Value	Mechanism	1.1.1, 1.2, 1.3, 2.1.3, 2.1.4, 2.1.5, 4.4.1, 4.4.2, 4.4.3
CO6	TPS3	Apply	Value	Mechanism	1.1.1, 1.2, 1.3, 2.1.3, 2.1.4, 2.1.5, 4.4.1, 4.4.2, 4.4.3

Mapping with Programme Outcomes and Programme Specific Outcomes

Cos	PO1	PO2	PO3	PO4	PO5	PO6	PO7	PO8	PO9	PO10	PO11	PO12	PSO1	PSO2
CO1	M	L	----	----	----	M	S	M	M	----	M	M	----	----
CO2	S	M	L	----	----	S	S	S	S	----	S	S	----	----
CO3	S	M	L	----	----	S	----	S	S	----	S	S	----	----
CO4	S	M	L	----	----	S	S	S	S	----	S	S	----	----
CO5	S	M	L	----	----	S	S	S	S	----	S	S	----	----
CO6	S	M	L	----	----	S	S	S	S	----	S	S	----	----

S- Strong; M-Medium; L-Low

Assessment Pattern: Cognitive Domain

Cognitive Levels	Continuous Assessment Tests			Assignment			Terminal Examination
	1	2	3	1	2	3	
Remember	10	10	10	-	-	-	10
Understand	10	10	10	-	-	-	10
Apply	80	80	80	100	100	100	80
Analyse				-	-	-	
Evaluate				-	-	-	
Create				-	-	-	

Assessment Pattern: Psychomotor

Psychomotor Skill	Miniproject /Assignment/Practical Component
Perception	-
Set	-
Guided Response	-
Mechanism	Assignment
Complex Overt Responses	-
Adaptation	-
Origination	-

Sample Questions for Course Outcome Assessment**

** (2 to 3 at the cognitive level of course outcome)

Course Level Learning Objectives**Course Outcome (CO1)**

1. What is Richter Magnitude?
2. What is Peak ground Acceleration?
3. What is meant by hazard mitigation?

Course Outcome (CO2)

1. List the different types of droughts and highlight its various causes.
2. Define community Contingency Plan
3. How does the site soil affect the EQ response of structures?

Course Outcome (CO3)

1. Explain the plan, Mass and Geometric irregularities in the RC buildings. How these irregularities adversely affect the performance of the RC buildings during Earthquake
2. Discuss the various types of natural disasters and highlight the specific efforts to mitigate disasters in India

Course Outcome (CO4)

1. Describe various types of hazards and impacts associated with earthquakes and highlight the lessons learnt
2. Briefly explain the components of follow-up activities in psychological rehabilitation of disaster affected people.

Course Outcome (CO5)

1. If you were the relief commissioner of the state of Assam which is affected by floods every year list out five departments that you need to contact.
2. Identify four different task forces and list out two responsibilities of each of the task forces
3. Do you think disaster risk can be reduced through community participation? Discuss

Course Outcome (CO6)

1. Which areas are more prone to heat and cold waves in India? Discuss the preventive and preparedness measures that are mostly adopted for protection from heat and cold waves
2. Explain the role of central Government in responding to disasters
3. Describe suitable mitigation and preparedness measures that the community should take in advance to guard a EQ disaster occurring again.

Concept Map

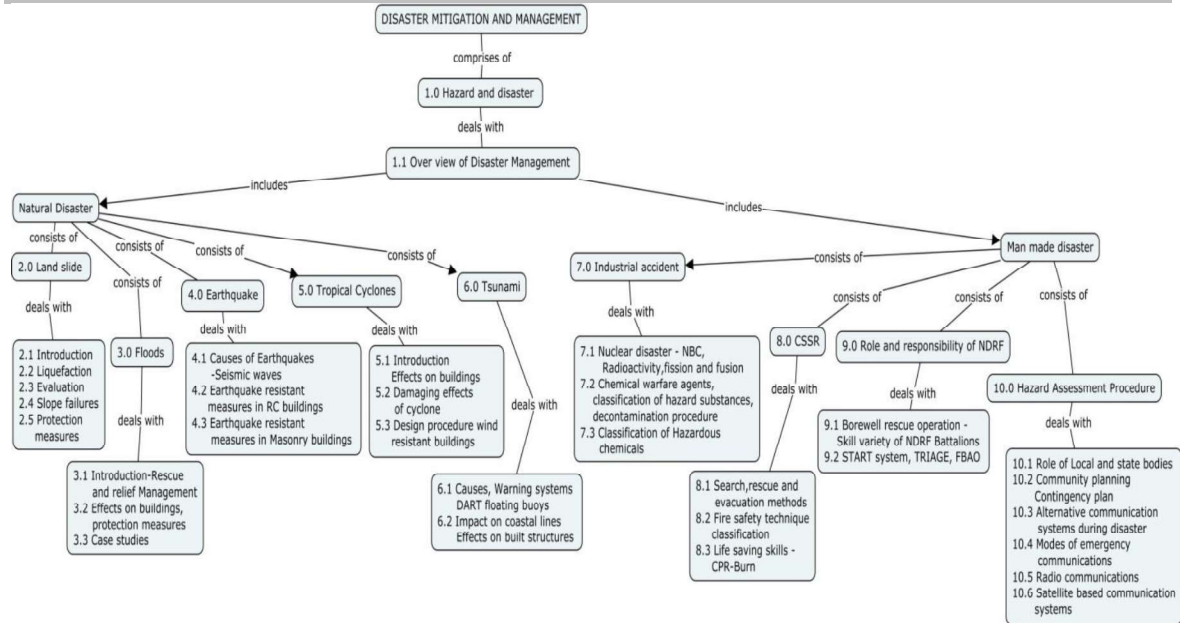

Syllabus

Hazard and disaster -Overview –Types of disasters-Phases of disaster Management - Classification of Hazards - Manmade and Natural disaster **Natural disaster- Earthquake** - Causes -Classification of Earthquakes – Magnitude and intensity - Potential deficiencies of RC and Masonry buildings -EQ resistant measures - **Landslides** -Causes – slopes failure - Preparation of zoning map -Liquefaction potential evaluation -Protection measures **Floods** – Flood zone map - Effects on buildings – protection measures from damage to buildings – Mitigation Strategies **Tropical cyclones** – stages of cyclone warning systems in India - Effects on buildings – protection measures from damage to buildings **Tsunami** - Warning systems

DART floating bouys -Tsunami impact on coastal lines -Effects of Tsunami on built structures – Mitigation Management **Manmade disaster - Nuclear disaster** – NBC, Radioactivity, Alpha ,Beta , Gamma decay, fission and fusion Chemical warfare agents, universal classification of hazard substances and explosives, decontamination procedure - BW agents -Emergency Medical responder, Vital signs (RPSBP) Classification of Hazardous chemicals **chemical and industrial accidents** – case histories Mitigation strategies **CSSR -Collapsed Structure & Rescue operations** - Search and rescue and evacuation methods - Life saving skills - Body mechanics – CPR **Fire safety technique classification -Extinguishers- Burn and its classification Borewell rescue operation Role and responsibility of NDRF** - Skill variety of NDRF Battalions-MFR-FRRM, CBRN disasters - START system, TRIAGE, FBAO (Foreign body airway Obstruction) **Role of local and state bodies** National level, State level, district level -Community contingency plan –Risk Management - Vulnerability mapping. **Hazard Assessment** - Vulnerability Assessment of Buildings procedure - Visual Inspection Detailed In - situ Investigation Planning and Interpretation of Results – Pushover Analysis **Alternative communication systems during disaster-** Modes of emergency communications-Satellite based communication systems -Radio communications

Reference Books:

1. David A. McEntire (2014) Disaster Response and Recovery: Strategies and Tactics for Resilience, Wiley Publishers
2. [R. B. Singh](#) (2006) Natural Hazards and Disaster Management: Vulnerability and Mitigation , Rawat Publications
3. [Pradyumna P. Karan](#) (2010)The Indian Ocean Tsunami: The Global Response to a Natural Disaster,[University Press of Kentucky](#)
4. Matthew R. Stein (2011)When Disaster Strikes: A Comprehensive Guide for Emergency Prepping and Crisis Survival. Chelsea Green Publishing
5. Dowrick. D.J (1987), “Earthquake resistant design for Engineers and Architects”, John Wiley & Sons, Second Edition.
6. G.K. Ghosh(1993) “Disaster Management” A.P.H. Publishing Corporation, New Delhi
7. R.B. Singh (1992)“Disaster Management” Rawat Publications, New Delhi
8. Ayaz Ahmad(1990) Disaster Management: Through the New Millennium By Anmol Publications, New Delhi
9. Goel, S. L.(1991) “Encyclopaedia of Disaster Management” Deep & Deep Publications Pvt Ltd, New Delhi

IS Codes:

1. IS: 4326-1984, “Indian Std Code of practice for Earthquake Resistant Design and Construction of Buildings”.
2. IS: 1893 (Part I)-2002 “Code of practice for Earthquake Resistant Design of Structures

Course Content and Lecture Schedule

Module No.	Topic	No. of Hours	Course Outcome
1	Introduction - Disaster		
1.1	Over view of Disaster Management	1	CO1
2	Land slide		
2.1	Introduction, Causes, types, preparation of hazard zonation map	1	CO2
2.2	Liquefaction	1	CO2
2.3	Evaluation of Liquefaction potential	1	CO2
2.4	Slope failures	1	CO2
2.5	Protection measures	2	CO2

3	Floods		
3.1	Introduction- Causes -Rescue and relief Management	1	CO2
3.2	Effects on buildings, protection measures from damage to buildings	1	CO2
3.3	Case studies	1	CO2
4	Earthquake Disaster		
4.1	Causes of Earthquakes, Earthquake Size Seismic waves	2	CO2
4.2	Earthquake resistant measures in RC buildings	1	CO2
4.3	Earthquake resistant measures in Masonry buildings	1	CO2
5	Tropical cyclones		
5.1	Introduction, Effects on buildings, Warning systems in India	1	CO2
5.2	Damaging effects of cyclone	1	CO2
5.3	Design procedure for wind resistant buildings	1	CO2
6	Tsunami		
6.1	Tsunami causes, Warning systems DART floating buoys	1	CO2
6.2	Tsunami impact on coastal lines Effects of Tsunami on built structures	1	CO2
7	Man made Disaster - Industrial accident case study	1	
7.1	Nuclear disaster - NBC, Radioactivity, Alpha ,Beta , Gamma decay, fission and fusion	1	CO3
7.2	Chemical warfare agents, universal classification of hazard substances and explosives, decontamination procedure - BW agents -Emergency Medical responder, Vital signs (RPSPBP)	2	CO3
7.3	Classification of Hazardous chemicals	1	CO3
8	CSSR -Collapsed Structure & Rescue operations		
8.1	Search and rescue and evacuation methods	1	CO3
8.2	Fire safety technique classification Extinguishers	1	CO3
8.3	Life saving skills - Body mechanics - CPR - Burn and its classification	1	CO3
9	Role and responsibility of NDRF	1	
9.1	Borewell rescue operation - Skill variety of NDRF Battalions-MFR- FRRM, CBRN disasters	1	CO4
9.2	START system, TRIAGE, FBAO (Foreign body airway Obstruction)	1	CO4
10	Hazard Assessment Procedure		
10.1	Role of Local and state bodies, RVS Method Screening	1	CO5
10.2	Community planning Community Contingency plan	1	CO5
10.3	Alternative communication systems during disaster	1	
10.4	Modes of emergency communications	1	CO6
10.5	Radio communications	1	CO6
10.6	Satellite based communication systems	1	CO6
	TOTAL	36	

Course Designers:1. Dr.R.Ponnudurai rpdciv@tce.edu

2. R.Indrajith Krishnan jith@tce.edu

18CEGD0	BASICS OF CLIMATE CHANGE
----------------	---------------------------------

Category	L	T	P	Credit
GE	3	0	0	3

Preamble

The aims of this course is to provide basic understanding about the climate system: its attributes, underlying processes, and the drivers of climate change. The course will also provide knowledge to assess impacts of climate change on natural resources and initiatives to mitigate and adapt it.

Prerequisite

NIL

Course Outcomes

On the successful completion of the course students will be able to

CO Number	Course Outcome Statement	Weightage*** in %
CO1	Understand the earth climate system and basic processes related to climate change.	20
CO2	Know the global and national policies to combat the climate change impacts	15
CO3	Assess the risk and vulnerability on different sectors due to climate change	15
CO4	Choose relevant technological option for mitigating climate change and adaptive techniques to build the climate resilience society	15
CO5	Assess the Climate related Issues in different engineering disciplines.	20
CO6	Gain awareness about the stress on natural based resources and to conserve it from natural calamities	15

*** Weightage depends on Bloom's Level, number of contact hours,

CO Mapping with CDIO Curriculum Framework

CO #	TCE Proficiency Scale	Learning Domain Level			CDIO Curricular Components (X.Y.Z)
		Cognitive	Affective	Psychomotor	
CO1	TPS2	Understand	Respond	Guided Response	1.1,2.3.1,2.3.2
CO2	TPS2	Understand	Respond	Guided Response	1.1,2.3.1,2.3.2
CO3	TPS3	Apply	Value	Mechanism	2.3.1,2.3.2,4.1.1,4.1.2,4.1.6,
CO4	TPS3	Apply	Value	Mechanism	2.3.1,2.3.2,4.1.1,4.1.2,4.1.6,
CO5	TPS3	Apply	Value	Mechanism	2.3.1,2.3.2,4.1.1,4.1.2,4.1.6,
CO6	TPS3	Apply	Value	Mechanism	2.3.1,2.3.2,4.1.1,4.1.2,4.1.6,

Mapping with Programme Outcomes and Programme Specific Outcomes

Cos	PO1	PO2	PO3	PO4	PO5	PO6	PO7	PO8	PO9	PO10	PO11	PO12	PSO1	PSO2
CO1	M	L	-	-	-	-	-	S	-	M	-	-	M	-
CO2	M	L	-	-	-	M	L	-	S	L	L	-	M	-
CO3	S	M	L	-	-	-	M	L	L	L	M	L	M	-
CO4	S	M	L	-	-	S	S	L	L	L	S	L	M	L

CO5	S	M	L	-	-	S	S	L	L	L	S	L	M	L
CO6	S	M	L	-	-	S	S	L	L	L	S	L	M	L

S- Strong; M-Medium; L-Low

Assessment Pattern: Cognitive Domain

Cognitive Levels	Continuous Assessment Tests			Assignment			Terminal Examination
	1	2	3	1	2	3	
Remember	12	12	12	-	-	-	12
Understand	48	48	48	-	-	-	48
Apply	40	40	40	10	10	10	40
Analyse							
Evaluate							
Create							

Assessment Pattern: Psychomotor

Psychomotor Skill	Mini project/Assignment/Practical Component
Perception	-
Set	-
Guided Response	50
Mechanism	50
Complex Overt Responses	-
Adaptation	-
Origination	-

Sample Questions for Course Outcome Assessment**

** (2 to 3 at the cognitive level of course outcome)

Course Outcome1(CO1):

1. Summarize your views on climate change and explore the answers for unanswered questions behind it.
2. Draw the atmospheric profile of temperature
3. List the Green House gases.

CourseOutcome2 (CO2):

1. Critically analyze the roles and responsibilities of various agencies towards fighting Global Warming and Climate change.
2. Write the salient features of Kyoto protocol

CourseOutcome3 (CO3):

1. Explain the current Vulnerabilities in water Resources sector.
2. Analyze the Vulnerability of Forestry sector and explore the different Adaptation and mitigation options with respect to Climate Change.

Course Outcome 4 (CO4):

1. Write funding status of Indian Government on climate change mitigation and adaptation.
2. What is the difference between mitigation and adaptation

Course Outcome 5 (CO5):

1. Discuss the uncertainties in the projected impact of climate change.
2. How climate change affects human health in dry and arid region?

CourseOutcome6 (CO6):

1. The consumption of fuel in India is increasing everyday and cost of it too. Propose a suitable alternate fuel for the future after analyzing the pros and cons of its implementation
2. Discuss the interaction between Climate change and Sustainable Development

Concept Map

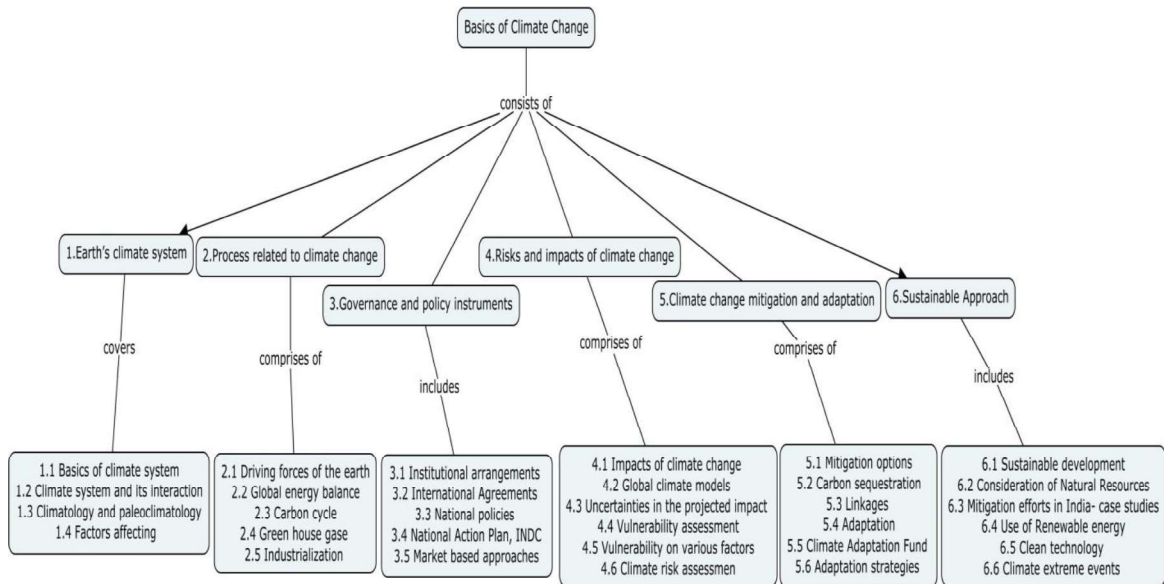

Syllabus

Earth's climate system Basics of climate system and its interaction, paleoclimatology-measurement techniques, Factors affecting global, regional and local climates **Process related to climate change** driving forces of the earth, Global energy balance, Carbon cycle, Green house gases, Industrialization and Urbanization. **Risks and impacts of climate change** Impacts of climate change on various sectors, climate models and scenarios, Vulnerability assessment on various sector, Climate risk assessment. **Climate change mitigation and adaptation** Long term and short term mitigation, Linkages between mitigation and adaptation, Adaptation strategies in various sectors. **Governance and policy instruments** National Action Plan on Climate Change, Market based approaches, International Agreements and protocols. **Sustainable Approach** Climate change and sustainable development, Future use of Renewable energy, clean technology and Alternate energy, climate extreme events and natural based solutions for conservation

Learning Resources

1. IPCC Fifth Assessment Report - Impacts, Adaptation and Vulnerability, Cambridge University Press, 2014.
2. Neelin David J, "Climate Change and Climate Modelling", Cambridge University Press, 2011.
3. Climate Change – The Science, Impacts and Solutions (2nd Edition) – A. Barrie Pittock,CSIRO Publishing, 2009.
4. Fundamentals of weather and climate (2nd Edition) – Robin McIlveen, Oxford University Press, 2009
5. Climate change – Mitigation of Climate, IPCC, 2013.

Course Contents and Lecture Schedule

Module No.	Topic	No. of Hours	Course Outcome
1.	Earth's climate system		
1.1	Basics of climate system- Fundamentals of meteorology and atmospheric profile	1	CO1

1.2	Climate system and its interaction	1	CO1
1.3	Climatology and paleoclimatology-measurement techniques	1	CO1
1.4	Factors affecting global, regional and local climates	1	CO1
2.	Process related to climate change		
2.1	Structure and driving forces of the earth	1	CO1
2.2	Global energy balance- Global ocean circulation and southern oscillation	1	CO1
2.3	Carbon cycle- earth's carbon reservoir	1	CO1
2.4	Green house gases and global warming	1	CO5
2.5	Industrialization and Urbanization-emission status global and national.	1	CO5
3.	Governance and policy instruments		
3.1	Institutional arrangements – Historical events	1	CO2
3.2	International Agreements and protocols	1	CO2
3.3	National policies and Regulatory approaches.	1	CO2
3.4	National Action Plan on Climate Change, INDC	1	CO2
3.5	Market based approaches(CDM,REDD,REDDTT)	1	CO2
4.	Risks and impacts of climate change		
4.1	Impacts of climate change on various sectors agriculture, ecosystem, water resources, human health and forestry	2	CO5
4.2	Global climate models and scenarios-projected impact	1	CO5
4.3	Uncertainties in the projected impact of the climate change for different regions	1	CO3
4.4	Vulnerability assessment-terminology and indicators IPCC	2	CO3
4.5	Vulnerability on water, agriculture, forestry, coastal and health	2	CO3
4.6	Climate risk assessment	1	CO3
5.	Climate change mitigation and adaptation		
5.1	Long term and short term mitigation options	1	CO4
5.2	Carbon capture and carbon sequestration	1	CO4
5.3	Linkages between mitigation and adaptation of Climate Change	1	CO4
5.4	Community and ecological based Adaptation	1	CO4
5.5	Climate Adaptation Fund and Insurance	1	CO4
5.6	Adaptation strategies options in various sectors	1	CO4
6.	Sustainable Approach		
6.1	Climate change and sustainable development	1	CO6
6.2	Need for consideration of Natural Resources	2	CO6
6.3	Mitigation efforts in India- case studies	1	CO5
6.4	Future use of Renewable energy	1	CO6
6.5	clean technology and Alternate energy	1	CO6
6.6	climate extreme events and natural based solutions for conservation	1	CO5
	TOTAL	36	

Course Designers:

1. Dr. V. RaviSankar environmentengr@tce.edu
2. Dr. S. Chandran schandran@tce.edu
3. Mr.R.K.C.Jeykumar rkjey@tce.edu

18CEGE0	ROAD SAFETY				
	Category	L	T	P	Credit
	GE	3	0	0	3

Preamble

The course has an exposure to the basic principles of road safety, traffic rules and regulations. It provides broad ideas and suggestions for safety of vulnerable road users.

Prerequisite

Nil

Course Outcomes

On the successful completion of the course students will be able to

CO Number	Course Outcome Statement	Weightage*** in %
CO1	Explain the objectives of road safety and its components	15
CO2	Enumerate the rules and regulations of road safety	15
CO3	Apply the methods of traffic control aids in road network	20
CO4	Adapt an appropriate road safety management technique for congested traffic pattern	20
CO5	Suggest the suitable road safety programme for accident prone zones	15
CO6	Apply the safety measures for vulnerable road users under different scenarios	15

*** Weightage depends on Bloom's Level, number of contact hours,

CO Mapping with CDIO Curriculum Framework

CO #	TCE Proficiency Scale	Learning Domain Level			CDIO Curricular Components (X.Y.Z)
		Cognitive	Affective	Psychomotor	
CO1	TPS3	Apply	Value	Mechanism	1.1.1, 1.1.2, 2.1.1, 2.1.5, 2.2.1, 2.3.1, 3.3.1, 4.1.1
CO2	TPS2	Understand	Respond	Guided Response	1.1.1, 1.1.2, 2.1.1, 2.2.1, 2.5.3, 3.3.1
CO3	TPS3	Apply	Value	Mechanism	1.1.1, 1.1.2, 2.1.1, 2.1.5, 2.2.4, 2.3.3, 2.4.7, 3.3.1, 4.4.4, 4.5.6, 4.6.6
CO4	TPS3	Apply	Value	Mechanism	1.1.1, 1.1.2, 2.1.1, 2.1.5, 2.2.1, 2.4.4, 2.5.4, 3.3.1, 4.1.1, 4.5.6, 4.6.6
CO5	TPS3	Apply	Value	Mechanism	1.1.1, 1.1.2, 2.1.1, 2.1.5, 2.2.1, 2.4.4, 2.5.4, 3.3.1, 4.1.1, 4.4.4, 4.6.6
CO6	TPS3	Apply	Value	Mechanism	1.1.1, 1.1.2, 2.1.1, 2.2.4, 2.3.3, 2.4.7, 2.5.4, 3.3.1, 4.1.1, 4.4.4, 4.5.6, 4.6.6

Mapping with Programme Outcomes and Programme Specific Outcomes

Cos	PO1	PO2	PO3	PO4	PO5	PO6	PO7	PO8	PO9	PO10	PO11	PO12	PSO1	PSO2
CO	S	M	L	-	-	S	-	L	L	-	-	S	M	L

1														
CO 2	M	L	-	-	-	S	-	M	M	S	M	L	L	M
CO 3	S	M	L	-	-	S	S	M	L	-	S	L	M	M
CO 4	S	M	L	-	-	S	S	M	L	-	S	M	M	M
CO 5	S	M	L	-	-	S	S	S	M	S	S	M	M	S
CO 6	S	M	L	-	-	S	L	S	L	-	M	L	M	M

S- Strong; M-Medium; L-Low

Assessment Pattern: Cognitive Domain

Bloom's Category	Continuous Assessment Tests			Assignment			Terminal Examination
	1	2	3	1	2	3	
Remember	20	20	20	-	-	-	20
Understand	40	20	20	-	-	-	20
Apply	40	60	60	10	10	10	60
Analyse	0	0	0	-	-	-	0
Evaluate	0	0	0	-	-	-	0
Create	0	0	0	-	-	-	0

Assessment Pattern: Psychomotor

Psychomotor Skill	Miniproject /Assignment/Practical Component
Perception	-
Set	-
Guided Response	20
Mechanism	80
Complex Overt Responses	-
Adaptation	-
Origination	-

Sample Questions for Course Outcome Assessment

Course Outcome1(CO1):

1. Recall the Objectives of Road Safety
2. Match Road safety with Sustainable Development Goals
3. Apply the concept of collision and condition diagram for the accident spot

Course Outcome 2(CO2):

1. Prepare a report of government and NGO's role in road safety.
2. Discuss in detail about traffic laws in India.
3. Summarize National road safety policy.

Course Outcome3(CO3):

1. Discuss the road markings required to enhance road safety.
2. Assume a city has congested traffic patterns. Illustrate traffic signs for that city.
3. Review about Traffic signal diagram, types and Signal Coordination

Course Outcome 4 (CO4):

1. Demonstrate the concept of Transportation System Management for commercial area.
2. Explain about Intelligent transport system (ITS) in detail.

3. When the prohibition of left turning is applicable?

Course Outcome 5 (CO5):

1. Adapt road safety audit methodology for a road network to identify black spots.
2. Show the safety rating system for the given road stretch.
3. Compare road safety audit and road safety rating system.

Course Outcome 6(CO6):

1. Illustrate the tips and suggestions for safe driving at urban and rural locations.
2. Why accident rate is high in driving at night times?
3. Mention the precautions to be taken in long journey.

Concept Map

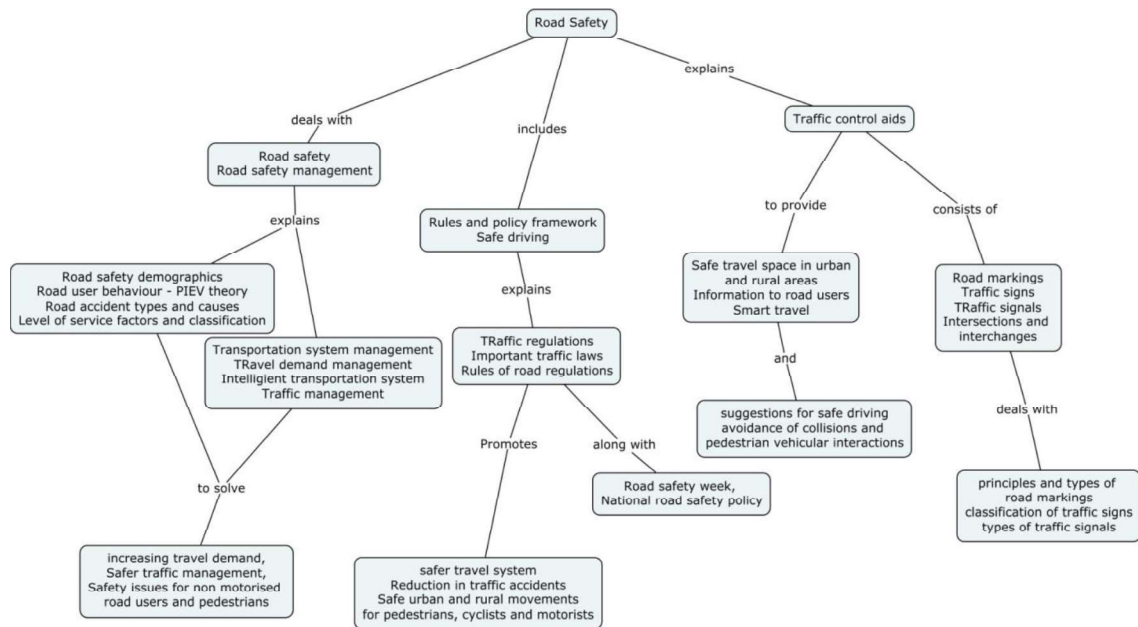

Syllabus

Introduction to Road Safety-Definition, Objectives, Road safety demographics,Road User behaviour-PIEV TheoryRoad Accident-Types, Causes, Data collection, Collision & Condition diagram, Preventative measures, Level of service-factors, Classification. **Rules and policy framework**-Traffic regulations – basic principles, Roles of Government and NGO’s, Important traffic laws and penalties-Motor Vehicle Act – 1988, Pedestrian law, Rules of Road Regulations – 1989, National Road Safety Policy, Parking regulations,Road safety week-Objectives, initiatives, International Best Practices. **Traffic control Aids**-Road markings- Functions, types, general principles,Traffic signs- Objective, classification,Traffic signals-Vehicle & Pedestrian signal, Important terms, types, concept of signal coordination,Intersection & Interchange-Forms, Classification. **Road Safety Management Techniques**-Transportation System Management-Purpose,Travel Demand Management-methods,Traffic Management-methods,Intelligent Transportation system,Case studies.**Road Safety Audit and rating system**-Road Safety Audit-Principles, Procedure, checklists, issues and counter measures,Road safety rating system-concept, process, measures,Case studies.**Tips and suggestions for safe driving**-Safety in urban and rural locations and intersections,safety in long journey, driving in night times, hill roads and tunnels,Regulatory measures for cyclists, motor cycle and scooter riders,Safety measures for pedestrians, Disabled, aged users,Safety at road works in progress

Learning Resources

1. Kadiyali L.R, "Traffic Engineering and Transport Planning", Khanna Publishers, New Delhi, seventh edition, 2011.
2. Elvik Rune, "The Handbook of Road Safety Measures", Emerald Group Publishing Limited, 2nd revised edition 2009
3. Ashwini Bagga and Nisha Bagga, "Essentials of Road Safety", Mayas Publishers, 2012
4. <https://nptel.ac.in/courses/105101087/>
5. <https://morth.nic.in/road-safety>

Course Contents and Lecture Schedule			
Module No.	Topic	No. of Hours	Course Outcome
1	Introduction to Road Safety		
1.1	Definition, Objectives, Road safety demographics	1	CO1
1.2	Road User behaviour-PIEV Theory	1	CO1
1.3	Road Accident-Types, Causes, Data collection, Collision & Condition diagram, Preventative measures	2	CO1
1.4	Level of service-factors, Classification	1	CO1
2	Rules and policy framework		
2.1	Traffic regulations – basic principles, Roles of Government and NGO's,	1	CO2
2.2	Important traffic laws and penalties-Motor Vehicle Act – 1988, Pedestrian law	1	CO2
2.3	Rules of Road Regulations – 1989, National Road Safety Policy, Parking regulations	1	CO2
2.4	Road safety week-Objectives, initiatives	1	CO2
2.5	International Best Practices	1	CO2
3	Traffic control Aids		
3.1	Road markings- Functions, types, general principles	2	CO3
3.2	Traffic signs- Objective, classification	2	CO3
3.3	Traffic signals-Vehicle & Pedestrian signal, Important terms, types, concept of signal coordination	2	CO3
3.4	Intersection & Interchange-Forms, Classification	1	CO3
4	Road Safety Management Techniques		
4.1	Transportation System Management-Purpose	1	CO4
4.2	Travel Demand Management-methods	2	CO4
4.3	Traffic Management-methods	2	CO4
4.4	Intelligent Transportation system	2	CO4
	Case studies		
5	Road Safety Audit and rating system		
5.1	Road Safety Audit-Principles, Procedure, checklists, issues and counter measures	3	CO5
5.2	Road safety rating system-concept, process, measures	3	CO5
	Case studies		
6	Tips and suggestions for safe driving		
6.1	Safety in urban and rural locations and intersections	1	CO6
6.2	safety in long journey, driving in night times, hill roads and tunnels	1	CO6
6.3	Regulatory measures for cyclists, motor cycle and scooter riders	1	CO6
6.4	Safety measures for pedestrians, Disabled, aged users	2	CO6

6.5	Safety at road works in progress	1	CO6
Total Hours		36	

Course Designers:

1. Dr. R. Velkennedy rvkciv@tce.edu
2. Ms.T.Karthigaipriya karthigaipriya@tce.edu

18CHAB0	CONSTITUTION OF INDIA
----------------	------------------------------

Category	L	T	P	Credit
AC	2	0	0	0

Preamble

The Constitution of India is the sovereign law of the land. It promises justice, liberty and equality to the people of India. For this, the Constitution carries the basic notion of rule of law i.e. limited government, and provides the structure, procedures, powers, and duties of government institutions, and sets out fundamental rights, directive principles, and the duties of citizens. The aims of this course is to provide basic understanding about Constitution.

Prerequisite

NIL

Course Outcomes

On the successful completion of the course students will be able to

CO Number	Course Outcome Statement	Weightage*** in %
CO1	Understand the salient features of Indian Constitution.	20
CO2	Explain the Fundamental Rights and duties incorporated in the Indian Constitution.	40
CO3	Discuss the specific provisions mentioned in the Indian constitution to ensure the rule of Law.	40

*** Weightage depends on Bloom's Level, number of contact hours,

Course Outcome1(CO1):

1. Discuss the key features of Indian constitution
2. Explain the Relationship between Directive Principles and Fundamental Rights

Course Outcome2 (CO2):

1. Rewrite the article 21 .
2. List the articles on constitutional remedies.

Course Outcome3 (CO3):

1. Explain the emergency provisions mentioned in the Constitution.
2. Illustrate the Structure of Indian Judiciary system .

Concept Map

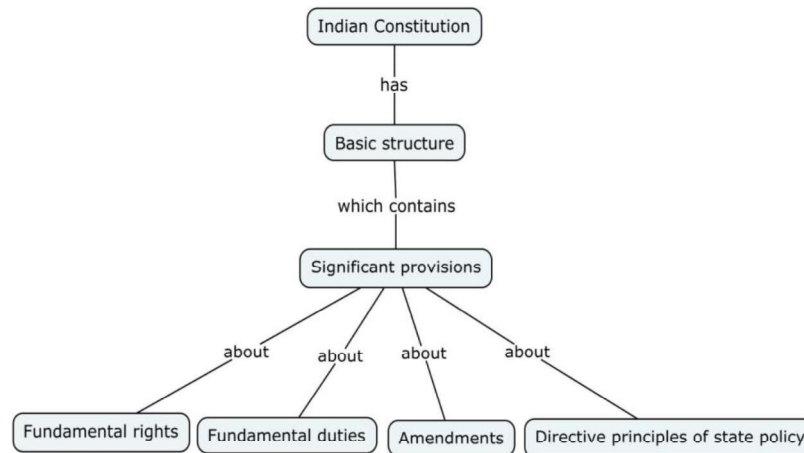

Syllabus

Constitution of India-Historical perspective, Salient features and characteristics, The Directive Principles of State Policy, Fundamental Duties & Fundamental Rights - Rights to Equality, Cultural and educational rights, Right to Life and Personal Liberty, Right to Constitutional remedies, Rights against exploitation, Right to Constitutional remedies, Right to property, Parliament and state legislature-Legislative relations between Union and state, Emergency Provisions, Structure of Indian Judiciary-Indian legal framework, Amendment of the Constitutional Powers, Public interest litigation. Access to Justice and Legal Aid in India. - Case Laws.

Learning Resources

1. <https://www.india.gov.in/my-government/constitution-india>

Course Contents and Lecture Schedule

Module No.	Topic	No. of Hours	Course Outcome
1	Historical perspective of the Constitution of India - Preamble	1	CO1
2	Salient features and characteristics of the Constitution of India	1	CO1
3	fundamental rights and their enforceability.	1	CO1
4	Fundamental Duties and its legal status	1	CO1
5	The Directive Principles of State Policy – Its importance and implementation	1	CO1
6	Relationship between Directive Principles and Fundamental Rights	1	CO1
7	Fundamental Rights to Equality – article-17 and 18	1	CO2
8	Fundamental freedoms and reasonable restrictions – Article 19 -22	1	CO2
9	Cultural and educational rights Article 29 & 30	1	CO2
10	protection against arrest and detention	1	CO2
11	Rights against exploitation Article 23-24	1	CO2
12	Right to Life and Personal Liberty under Article 21	1	CO2
13	Right to Constitutional remedies	1	CO2
14	Right to property	1	CO2
15	Legislative relations between Union and state.	1	CO3
16	Parliament and state legislature	1	CO3
17	Emergency Provisions : National Emergency, President Rule, Financial Emergency	1	CO3
18	Structure of Indian Judiciary under the Constitution	1	CO3
19	Public interest litigation.	1	CO3

20	The Indian legal framework	2	CO3
21	Amendment of the Constitutional Powers and Procedure	1	CO3
22	Access to Justice and Legal Aid in India. - Case Laws	2	CO3
TOTAL		24	

Course Designer

1.Dr.V.Ravisankar environmentengr@tce.edu