

CURRICULUM AND DETAILED SYLLABI

FOR

B.E. DEGREE PROGRAMME

IN

ELECTRONICS AND COMMUNICATION ENGINEERING

FOR THE STUDENTS ADMITTED IN THE

ACADEMIC YEAR 2016-17 ONWARDS

**DEPARTMENT OF ELECTRONICS AND COMMUNICATION
ENGINEERING**

THIAGARAJAR COLLEGE OF ENGINEERING

(A Government Aided ISO 9001:2008 certified Autonomous Institution affiliated to Anna University)

MADURAI – 625 015, TAMILNADU

Phone: 0452 – 2482240, 41

Fax: 0452 2483427

Web: www.tce.edu

Vision and Mission of the Department

Vision:

To empower the Electronics and Communication Engineering students with technological excellence, professional commitment and social responsibility.

Mission:

- ME1. Attaining academic excellence in Electronics and Communication Engineering through dedication to duty, innovation in learning and research, state of the art laboratories and industry driven skill development.
- ME2. Establishing suitable environment for the students to develop professionalism and face life challenges with ethical integrity.
- ME3. Nurturing the students to understand the societal needs and equip them with technical expertise to provide appropriate solutions.
- ME4. Providing breeding ground to obtain entrepreneurial skills and leadership qualities for self and social growth.

Program Educational Objectives (PEOs) :

- PEO1. Graduates will be capable of developing specification and design procedures, prototyping and test methodologies for modern electronics and communication systems and gadgets that perform analog and digital processing functions.
- PEO2. Graduates will be able to work and adapt to changes in allied areas of Electronics and Communication Engineering through personal success and life long learning.
- PEO3. Graduates will be able to identify technological requirements for the society and provide cost effective solutions.
 - These objectives will be evidenced by professional visibility (publications, presentations, inventions, patents and awards), entrepreneurial activities, international activities (participation in international conferences, collaborative research and employment abroad)

Program Outcomes:

Engineering Graduates will be able to:

1. **Engineering knowledge:** Apply the knowledge of mathematics, science, engineering fundamentals, and an engineering specialization to the solution of complex engineering problems.
2. **Problem analysis:** Identify, formulate, review research literature, and analyze complex engineering problems reaching substantiated conclusions using first principles of mathematics, natural sciences, and engineering sciences.
3. **Design/development of solutions:** Design solutions for complex engineering problems and design system components or processes that meet the specified needs with appropriate consideration for the public health and safety, and the cultural, societal, and environmental considerations.
4. **Conduct investigations of complex problems:** Use research-based knowledge and research methods including design of experiments, analysis and interpretation of data, and synthesis of the information to provide valid conclusions.
5. **Modern tool usage:** Create, select, and apply appropriate techniques, resources, and modern engineering and IT tools including prediction and modeling to complex engineering activities with an understanding of the limitations.
6. **The engineer and society:** Apply reasoning informed by the contextual knowledge to assess societal, health, safety, legal and cultural issues and the consequent responsibilities relevant to the professional engineering practice.
7. **Environment and sustainability:** Understand the impact of the professional engineering solutions in societal and environmental contexts, and demonstrate the knowledge of, and need for sustainable development.
8. **Ethics:** Apply ethical principles and commit to professional ethics and responsibilities and norms of the engineering practice.
9. **Individual and team work:** Function effectively as an individual, and as a member or leader in diverse teams, and in multidisciplinary settings.
10. **Communication:** Communicate effectively on complex engineering activities with the engineering community and with society at large, such as, being able to comprehend and write effective reports and design documentation, make effective presentations, and give and receive clear instructions.
11. **Project management and finance:** Demonstrate knowledge and understanding of the engineering and management principles and apply these to one's own work, as a member and leader in a team, to manage projects and in multidisciplinary environments.
12. **Life-long learning:** Recognize the need for, and have the preparation and ability to engage in independent and life-long learning in the broadest context of technological change.

Program Specific Outcomes:

Engineering Graduates will be able to

- PSO1. Design circuits and systems for complex engineering problems in Electronics and Communication and allied areas.
- PSO2. Apply research methodologies to provide solutions for contemporary problems in the areas including RF, Signal Processing, Image Processing, VLSI, Optical Communication, Networks and Embedded Systems for given specifications.
- PSO3. Actively contribute as a member or leader in diverse teams, and communicate effectively on complex engineering activities and involve in life-long learning, by applying reasoning and ethical principles.

THIAGARAJAR COLLEGE OF ENGINEERING, MADURAI- 625 015

(A Govt. Aided, ISO 9001:2008 certified Autonomous Institution affiliated to Anna University)

**CATEGORIZATION OF COURSES
(CHOICE BASED CREDIT SYSTEM)**

Degree: B.E

Programme: ECE

Batch: 2015-16

A. Compulsory Foundation Courses: Total Credits to be earned: (48-63)

a. Humanities and Social Science (12-15)

S.No	Course Code	Name of the Course	Number of Hours / Week			Credit	Prerequisite
			L	T	P		
THEORY							
1.	14EG141	English	3	-	-	3	-
2.	14EC250	Environment Science	3	-	-	3	-
3.	14EC610	Management Theory and Practice	3	-	-	3	-
4.	14EC710	Accounting and Finance	3	-	-	3	-
THEORY CUM PRACTICAL							
1.	14EC670	Professional Communication	1	-	2	2	-

b. Basic Science (15-21)

S.No	Course Code	Name of the Course	Number of Hours / Week			Credit	Prerequisite
			L	T	P		
THEORY							
1.	14MA110	Engineering Mathematics-I	2	2	-	3	-
2.	14PH120	Physics	3	-	-	3	-
3.	14CH130	Chemistry	3	-	-	3	-
4.	14EC210	Engineering Mathematics-II	2	2	-	3	-
5.	14EC310	Partial Differential Equations and Linear Algebra	2	2	-	3	-
6.	14EC410	Numerical Methods and Optimization	2	2	-	3	-
THEORY CUM PRACTICAL							
-	-	-	-	-	-	-	-
PRACTICAL							
1.	14PH180	Physics Laboratory	-	-	2	1	-
2.	14CH190	Chemistry Laboratory	-	-	2	1	-

B. Core courses**Credits to be earned: (63-72)**

S. No	Course Code	Name of the Course	Number of Hours / Week			Credit	Prerequisite
			L	T	P		
THEORY							
1.	14EC220*	Passive Network Analysis and Synthesis	2	2	-	3	-
2.	14EC230*	Semiconductor Devices	3	-	-	3	-
3.	14EC330*	Electronic Circuit Design	3	-	-	3	-
4.	14EC340*	Signals and Systems	2	2	-	3	-
5.	14EC350*	Electromagnetics	2	2	-	3	-
6.	14EC420*	Microcontrollers	3	-	-	3	14EC370
7.	15EC430*	RF Transmission Lines and Passive Circuits	3	-	-	3	14EC350
8.	14EC440*	Signal Processing	2	2	-	3	14EC340
9.	14EC4C1	Capstone Course I	-	-	2	2	-
10.	14EC510*	Data Communication Networks	3	-	-	3	-
11.	14EC520*	Digital CMOS Systems	3	-	-	3	14EC330
12.	15EC530*	RF Active Circuits	3	-	-	3	15EC431
13.	14EC540*	Analog and Digital Communication Systems	2	2	-	3	14EC340
14.	14EC620*	Wireless Communication Systems	2	2	-	3	14EC540
15.	15EC630*	Antennas and Wave Propagation	2	2	-	3	15EC431
16.	14EC720	Optical Communication Networks	3	-	-	3	-
17.	14EC7C0	Capstone Course II	-	-	2	2	-
THEORY CUM PRACTICAL							
1.	14EC270*	Digital Logic Circuit Design	2	-	2	3	-
2.	14EC370*	Microprocessor Architecture and Programming	2	-	2	3	-
3.	14EC470*	Active Circuits Analysis and Synthesis	2	-	2	3	14EC330
4.	14EC570*	Image Processing	2	-	2	3	14EC440
5.	14EC770	ASIC Design	2	-	2	3	14EC520
PRACTICAL							
1.	14EC280*	Circuits and Devices Lab	-	-	2	1	-
2.	14EC390*	Electronic Circuit Design Laboratory	-	-	2	1	-
3.	14EC480*	Microcontroller Laboratory	-	-	2	1	-
4.	14EC490*	Signal Processing Laboratory	-	-	2	1	-
5.	14EC580*	Data Communication Networking Laboratory	-	-	2	1	-
6.	14EC590*	Analog and Digital Communications Laboratory	-	-	2	1	-
7.	14EC680*	Microwave and Antenna Lab	-	-	2	1	15EC431
8.	14EC690*	System Design and Testing Lab	-	-	2	1	15EC431
9.	14EC780*	Elective Lab	-	-	2	1	-

*Mandatory courses

C. Elective Courses:**(27-39)****a. Programme Specific Elective****Credits to be earned: (12-15)**

S.No	Course Code	Name of the Course	Number of Hours / Week			Credit	Prerequisite
			L	T	P		
1.	14ECPB0	Embedded System Design	3	-	-	3	14EC420
2.	14ECPC0	Digital System Design using FPGA	3	-	-	3	-
3.	14ECPD0	Control Systems	2	2	-	3	14EC440
4.	14ECPG0	Statistical Signal Processing	2	2	-	3	14EC440
5.	14ECPJ0	Bio-Medical Instrumentation	3	-	-	3	-
6.	14ECPK0	Network Security	3	-	-	3	-
7.	14ECPN0	VLSI Device Modeling	3	-	-	3	14EC520
8.	14ECPPO	Digital Video Processing	3	-	-	3	14EC570
9.	14ECPQ0	Medical Imaging and Processing	3	-	-	3	14EC570
10.	14ECPR0	Satellite Remote Sensing	3	-	-	3	-
11.	14ECP T0	Radio Frequency Integrated Circuits	3	-	-	3	14EC520
12.	14ECPW0	Mixed Signal Integrated Circuit	3	-	-	3	14EC330
13.	14ECPY0	Electrical and Electronic Measurement	3	-	-	3	14EC330
14.	14ECPZ0	Speech Signal Processing	2	2	-	3	14EC440
15.	14ECRD0	Data Compression	3	-	-	3	14EC440, 14EC570
16.	14ECRG0	Planar Antennas for Wireless Applications	3	-	-	3	14EC530
17.	14ECRH0	Wireless Technologies with Mobile Internet	3	-	-	3	14EC510
THEORY CUM PRACTICAL							
1.	14ECPA0	DSP Architecture and Programming	2	-	2	3	14EC440
2.	14ECPE0	Data Structures and Algorithms	2	-	2	3	14EC320, 14EC380
PRACTICAL							
	-	-	-	-	-	-	-

c. Interdisciplinary Elective***Credits to be earned: (06-12)**

S.No	Course Code	Name of the Course	Number of Hours / Week			Credit	Prerequisite
			L	T	P		
THEORY							
1.	14ECGA0	Consumer Electronics	3	-	-	3	-
2.	14ECGB0	Multimedia Systems	3	-	-	3	-
3.	14ECGC0	Telecom Systems	3	-	-	3	-
4.	14ECGD0	Image Processing and Applications	3	-	-	3	-

*OFFERED BY ECE DEPARTMENT TO OTHER B.E./B.Tech Programmes

d. Skill/Proficiency based Elective**Credits to be earned: 02-04****D. Project**

S.No	Course Code	Name of the Course	Number of Hours / Week			Credit	Prerequisite
			L	T	P		
1.	14EC880	Project	-	-	24	12	-

THIAGARAJAR COLLEGE OF ENGINEERING, MADURAI- 625 015

(A Govt. Aided, ISO 9001:2008 certified Autonomous Institution affiliated to Anna University)

**CATEGORIZATION OF COURSES
(CHOICE BASED CREDIT SYSTEM)**

Degree: B.E

Programme: ECE

Batch: 2016-17

E. Compulsory Foundation Courses: Total Credits to be earned: (48-63)

a. Humanities and Social Science (12-15)

S.No	Course Code	Name of the Course	Number of Hours / Week			Credit	Prerequisite
			L	T	P		
THEORY							
1.	14EG141	English	3	-	-	3	-
2.	14EC250	Environment Science	3	-	-	3	-
3.	14EC610	Management Theory and Practice	3	-	-	3	-
4.	14EC710	Accounting and Finance	3	-	-	3	-
THEORY CUM PRACTICAL							
1.	14EC670	Professional Communication	1	-	2	2	-

b. Basic Science (15-21)

S.No	Course Code	Name of the Course	Number of Hours / Week			Credit	Prerequisite
			L	T	P		
THEORY							
7.	14MA110	Engineering Mathematics-I	2	2	-	3	-
8.	14PH120	Physics	3	-	-	3	-
9.	14CH130	Chemistry	3	-	-	3	-
10.	14EC210	Engineering Mathematics-II	2	2	-	3	-
11.	14EC310	Partial Differential Equations and Linear Algebra	2	2	-	3	-
12.	14EC410	Numerical Methods and Optimization	2	2	-	3	-
THEORY CUM PRACTICAL							
-	-	-	-	-	-	-	-
PRACTICAL							
1.	14PH180	Physics Laboratory	-	-	2	1	-
2.	14CH190	Chemistry Laboratory	-	-	2	1	-

F. Core courses**Credits to be earned: (63-72)**

S. No	Course Code	Name of the Course	Number of Hours / Week			Credit	Prerequisite
			L	T	P		
THEORY							
18.	14EC220*	Passive Network Analysis and Synthesis	2	2	-	3	-
19.	14EC230*	Semiconductor Devices	3	-	-	3	-
20.	14EC330*	Electronic Circuit Design	3	-	-	3	-
21.	14EC340*	Signals and Systems	2	2	-	3	-
22.	14EC350*	Electromagnetics	2	2	-	3	-
23.	14EC420*	Microcontrollers	3	-	-	3	14EC370
24.	15EC431*	RF Transmission Lines and Passive Circuits	3	-	-	3	14EC350
25.	14EC440*	Signal Processing	2	2	-	3	14EC340
26.	14EC4C2	Capstone Course I	-	-	2	2	-
27.	14EC510*	Data Communication Networks	3	-	-	3	-
28.	14EC520*	Digital CMOS Systems	3	-	-	3	14EC330
29.	15EC531*	RF Active Circuits	3	-	-	3	15EC431
30.	14EC540*	Analog and Digital Communication Systems	2	2	-	3	14EC340
31.	14EC620*	Wireless Communication Systems	2	2	-	3	14EC540
32.	15EC630*	Antennas and Wave Propagation	2	2	-	3	15EC431
33.	14EC720	Optical Communication Networks	3	-	-	3	-
34.	14EC7C0	Capstone Course II	-	-	2	2	-
THEORY CUM PRACTICAL							
6.	14EC270*	Digital Logic Circuit Design	2	-	2	3	-
7.	14EC370*	Microprocessor Architecture and Programming	2	-	2	3	-
8.	14EC470*	Active Circuits Analysis and Synthesis	2	-	2	3	14EC330
9.	14EC570*	Image Processing	2	-	2	3	14EC440
10.	14EC770	ASIC Design	2	-	2	3	14EC520
PRACTICAL							
10.	14EC280*	Circuits and Devices Lab	-	-	2	1	-
11.	14EC390*	Electronic Circuit Design Laboratory	-	-	2	1	-
12.	14EC480*	Microcontroller Laboratory	-	-	2	1	-
13.	14EC490*	Signal Processing Laboratory	-	-	2	1	-
14.	14EC580*	Data Communication Networking Laboratory	-	-	2	1	-
15.	14EC590*	Analog and Digital Communications Laboratory	-	-	2	1	-
16.	14EC680*	Microwave and Antenna Lab	-	-	2	1	15EC431
17.	14EC690*	System Design and Testing Lab	-	-	2	1	15EC431
18.	14EC780*	Elective Lab	-	-	2	1	-

*Mandatory courses

G. Elective Courses:**(27-39)****a. Programme Specific Elective****Credits to be earned: (12-15)**

S.No	Course Code	Name of the Course	Number of Hours / Week			Credit	Prerequisite
			L	T	P		
18.	14ECPB0	Embedded System Design	3	-	-	3	14EC420
19.	14ECPC0	Digital System Design using FPGA	3	-	-	3	-
20.	14ECPD0	Control Systems	2	2	-	3	14EC440
21.	14ECPG0	Statistical Signal Processing	2	2	-	3	14EC440
22.	14ECPJ0	Bio-Medical Instrumentation	3	-	-	3	-
23.	14ECPK0	Network Security	3	-	-	3	-
24.	14ECPN0	VLSI Device Modeling	3	-	-	3	14EC520
25.	14ECPPO	Digital Video Processing	3	-	-	3	14EC570
26.	14ECPQ0	Medical Imaging and Processing	3	-	-	3	14EC570
27.	14ECPR0	Satellite Remote Sensing	3	-	-	3	-
28.	14ECP T0	Radio Frequency Integrated Circuits	3	-	-	3	14EC520
29.	14ECPW0	Mixed Signal Integrated Circuit	3	-	-	3	14EC330
30.	14ECPY0	Electrical and Electronic Measurement	3	-	-	3	14EC330
31.	14ECPZ0	Speech Signal Processing	2	2	-	3	14EC440
32.	14ECRD0	Data Compression	3	-	-	3	14EC440, 14EC570
33.	14ECRG0	Planar Antennas for Wireless Applications	3	-	-	3	14EC530
34.	14ECRH0	Wireless Technologies with Mobile Internet	3	-	-	3	14EC510
THEORY CUM PRACTICAL							
3.	14ECPA0	DSP Architecture and Programming	2	-	2	3	14EC440
4.	14ECPE0	Data Structures and Algorithms	2	-	2	3	14EC320, 14EC380
PRACTICAL							
	-	-	-	-	-	-	-

e. Interdisciplinary Elective***Credits to be earned: (06-12)**

S.No	Course Code	Name of the Course	Number of Hours / Week			Credit	Prerequisite
			L	T	P		
THEORY							
1.	14ECGA0	Consumer Electronics	3	-	-	3	-
2.	14ECGB0	Multimedia Systems	3	-	-	3	-
3.	14ECGC0	Telecom Systems	3	-	-	3	-
4.	14ECGD0	Image Processing and Applications	3	-	-	3	-

*OFFERED BY ECE DEPARTMENT TO OTHER B.E./B.Tech Programmes

f. Skill/Proficiency based Elective**Credits to be earned: 02-04****H. Project**

S.No	Course Code	Name of the Course	Number of Hours / Week			Credit	Prerequisite
			L	T	P		
1.	14EC880	Project	-	-	24	12	-

SCHEDULING OF COURSES (B.E. ECE Programme)*

Semester	Theory						Theory cum Practical	Practical		Special Courses	Credits
	1	2	3	4	5	6	7	8	9	10	
I	14MA110 Engineering Mathematics (3)	14PH120 Physics (3)	14CH130 Chemistry (3)	14EG140 English (3)	14ES150 Basics of Civil and Mechanical Engg (2)	14ES160 Basics of Electrical and Electronics Engg (2)	14ME170 Engineering Graphics (3)	14PH180 Physics Laboratory (1)	14CH190 Chemistry Laboratory (1)	-	21
II	14EC210 Engineering Mathematics II (3)	14EC220 Passive Network Analysis and Synthesis(3)	14EC230 Semiconductor Devices (3)	14EC240 Materials Science (3)	14EC250 Environment Science (3)	-	14EC270 Digital Logic Circuit Design (3)	14EC280 Circuit and Devices Lab (1)	14EC290 Workshop (1)	-	20
III	14EC310 Partial Differential Equations and Linear Algebra (3)	14EC320 Problem Solving using Computers (3)	14EC330 Electronic Circuit Design (3)	14EC340 Signals and Systems (3)	14EC350 Electromagnetics (3)	-	14EC370 Microprocessor Architecture and Programming (3)	14EC380 Computer Programming Lab (1)	14EC390 Electronic Circuit Design Lab (1)	-	20
IV	14EC410 Numerical Methods and Optimization (3)	14EC420 Microcontrollers (3)	15EC430 RF Transmission Lines and Passive Circuits (3)	14EC440 Signal Processing (3)	14EC450 Engineering by Design (3)	-	14EC470 Active Circuits Analysis and Synthesis (3)	14EC480 Microcontroller Lab (1)	14EC490 Signal Processing Lab (1)	14EC4C1 Capstone Course-I (2)	22
V	14EC510 Data Communication Networks (3)	14EC520 Digital CMOS Systems (3)	15EC530 RF Active Circuits (3)	14EC540 Analog and Digital Communication Systems (3)	14ECPX0 (3) Prog. Elec.I	-	14EC570 Image Processing (3)	14EC580 Data Communication Networking Lab (1)	14EC590 Analog and Digital Communication Lab (1)	-	20
VI	14EC610 Management Theory and Practice (3)	14EC620 Wireless Communication Systems (3)	15EC630 Antenna and Wave Propagation (3)	14ECPX0 (3) Prog. Elec.II	14ECGX0 (3) Gen.Elec.	-	14EC670 Professional Communication (2)	14EC680 Microwave and Antenna Lab (1)	14EC690 System Design and Testing Lab (1)	-	19
VII	14EC710 Accounting and Finance (3)	14EC720 Optical Communication Networks (3)	14ECPX0 (3) Prog. Elec.III	14ECPX0 (3) Prog. Elec.IV	14ECGX0 (3) Gen.Elec.	-	14EC770 ASIC Design (3)	14EC780 Elective Lab (1)		14EC7C0 Capstone Course-II (2)	21
VIII	14ECPX0 (3) Prog. Elec.V	14ECPX0 (3) Prog. Elec.VI	14ECPX0 (3) Prog. Elec.VII	-	-	-	-	14EC880 Project (12)		-	21

*This schedule shows an optimal way of completing the B.E. Degree programme successfully in 4 Years

Total Credits for Curricular Activities: 164

Programme Electives:

Course Code	Course Name
14ECPA0	DSP Architecture and Programming
14ECPB0	Embedded System Design
14ECPC0	Digital System Design using FPGA
14ECPD0	Control Systems
14ECEPE0	Data Structures and Algorithms
14ECPF0	Real Time System Design
14ECPG0	Statistical Signal Processing
14ECPH0	Radar Systems
14ECPJ0	Bio-Medical Instrumentation
14ECPK0	Network Security
14ECPL0	Software Defined and Cognitive Radio Networks
14ECPM0	Low Power VLSI Systems
14ECPN0	VLSI Device Modeling
14ECPPO	Digital Video Processing
14ECPQ0	Medical Imaging and Processing
14ECPRO	Satellite Remote Sensing
14ECPSS0	Internet of Things
14ECPST0	Radio Frequency Integrated Circuits
14ECPSTU	RF System Design and Measurements
14ECPV0	Physical Layer LTE System
14ECPW0	Mixed Signal Integrated Circuits
14ECPY0	Electrical and Electronic Measurement
14ECPZ0	Speech Signal Processing
14ECRA0	Audio Signal Processing
14ECRB0	Computer Vision and Applications
14ECRC0	Satellite Image Analysis
14ECRD0	Data Compression
14ECRE0	Electromagnetic Interference and Compatibility
14ECRF0	RF MEMS
14ECRG0	Planar Antennas for Wireless Applications
14ECRH0	Wireless Technologies with Mobile Internet
14ECRJ0	Adhoc and Sensor Networks
14ECRK0	Cooperative Communication Systems
14ECRL0	CAD for VLSI
14ECRM0	Image Analysis and Visualization

Industry Supported Courses:

Course Code	Course Name
14EC2A0	Device Characterization
14EC2B0	Semiconductor Modeling
14EC2C0	RF Design and Measurement Tools

THIAGARAJAR COLLEGE OF ENGINEERING: MADURAI – 625 015
B.E Degree (Electronics and Communication Engineering) Program

COURSES OF STUDY

(For the students admitted from the Academic year 2014-15)

SECOND SEMESTER

Course code	Name of the Course	Category	Number of Hours / Week			Credits
			L	T	P	
THEORY						
14EC210	Engineering Mathematics II	BS	2	2	-	3
14EC220	Passive Network Analysis and Synthesis	PC	2	2	-	3
14EC230	Semiconductor Devices	PC	3	-	-	3
14EC240	Materials Science	BS	3	-	-	3
14EC250	Environment Science	HSS	3	-	-	3
THEORY CUM PRACTICAL						
14EC270	Digital Logic Circuit Design	PC	2	-	2	3
PRACTICAL						
14EC280	Circuits and Devices Lab	PC	-	-	2	1
14EC290	Workshop	PC	-	-	2	1
Total			15	4	6	20

THIRD SEMESTER

Course code	Name of the Course	Category	Number of Hours / Week			Credits
			L	T	P	
THEORY						
14EC310	Partial Differential Equations and Linear Algebra	BS	2	2	-	3
14EC320	Problem Solving using Computers	ES	3	-	-	3
14EC330	Electronic Circuit Design	PC	3	-	-	3
14EC340	Signals and Systems	PC	2	2	-	3
14EC350	Electromagnetics	PC	2	2	-	3
THEORY CUM PRACTICAL						
14EC370	Microprocessor Architecture and Programming	PC	2	-	2	3
PRACTICAL						
14EC380	Computer Programming Laboratory	ES	-	-	2	1
14EC390	Electronic Circuit Design Laboratory	PC	-	-	2	1
Total			14	6	6	20

FOURTH SEMESTER

Course code	Name of the Course	Category	Number of Hours / Week			Credits
			L	T	P	
THEORY						
14EC410	Numerical Methods and Optimization	BS	2	2	-	3
14EC420	Microcontrollers	PC	3	-	-	3
15EC430	RF Transmission Lines and Passive Circuits	PC	3	-	-	3
14EC440	Signal Processing	PC	2	2	-	3
14EC450	Engineering Design	PC	1	-	2*	3

THEORY CUM PRACTICAL						
14EC470	Active Circuits Analysis and Synthesis	PC	2	-	2	3
PRACTICAL						
14EC480	Microcontroller Laboratory	PC	-	-	2	1
14EC490	Signal Processing Laboratory	PC	-	-	2	1
SPECIAL						
14EC4C1	Capstone Course I	PC	-	-	2*	2
Total			13	6	6	22

* 2 hours/week is allotted for off-class practical work

FIFTH SEMESTER

Course code	Name of the Course	Category	Number of Hours / Week			Credits
			L	T	P	
THEORY						
14EC510	Data Communication Networks	PC	3	-	-	3
14EC520	Digital CMOS Systems	PC	3	-	-	3
15EC530	RF Active Circuits	PC	3	-	-	3
14EC540	Analog and Digital Communication Systems	PC	2	2	-	3
14ECPX0	Programme Elective I	PC	3	-	-	3
THEORY CUM PRACTICAL						
14EC570	Image Processing	PC	2	-	2	3
PRACTICAL						
14EC580	Data Communication Networking Laboratory	PC	-	-	2	1
14EC590	Analog and Digital Communication Laboratory	PC	-	-	2	1
Total			16	2	6	20

SIXTH SEMESTER

Course code	Name of the Course	Category	Number of Hours / Week			Credits
			L	T	P	
THEORY						
14EC610	Management Theory and Practice	HSS	3	-	-	3
14EC620	Wireless Communication Systems	PC	2	2	-	3
15EC630	Antenna and Wave Propagation	PC	2	2	-	3
14ECPX0	Programme Elective II	PE	3	-	-	3
14ECGX0	General Elective I	PE	3	-	-	3
THEORY CUM PRACTICAL						
14EC670	Professional Communication	PC	1	-	2	2
PRACTICAL						
14EC680	Microwave and Antenna Lab	PC	-	-	2	1
14EC690	System Design and Testing Lab	PC	-	-	2	1
Total			15	2	6	19

SEVENTH SEMESTER

Course code	Name of the Course	Category	Number of Hours / Week			Credits
			L	T	P	
THEORY						
14EC710	Accounting and Finance	HSS	3	-	-	3
14EC720	Optical Communication Networks	PC	3	-	-	3
14ECPX0	Programme Elective III	PE	3	-	-	3
14ECPX0	Programme Elective IV	PE	3	-	-	3
14ECGX0	General Elective II	PE	3	-	-	3
14EC7C0	Capstone Course II	PC	-	-	4	2
THEORY CUM PRACTICAL						
14EC770	ASIC Design	PC	2	-	2	3
PRACTICAL						
14EC780	Elective Lab	PC	-	-	2	1
Total			16	2	4	19

EIGHTH SEMESTER

Course code	Name of the Course	Category	Number of Hours / Week			Credits
			L	T	P	
THEORY						
14ECPX0	Programme Elective V	PE	3	-	-	3
14ECPX0	Programme Elective VI	PE	3	-	-	3
14ECPX0	Programme Elective VII	PE	3	-	-	3
PRACTICAL						
14EC880	Project	PC	-	-	24	12
Total			9	-	24	21

BS : Basic Science
 HSS : Humanities and Social Science
 ES : Engineering Science
 PC : Programme core
 PE : Programme Elective
 L : Lecture
 T : Tutorial
 P : Practical

Note:

1 hour lecture/week is equivalent to 1 Credit
 2 hours Tutorial/week is equivalent to 1 Credit
 2 hours Practical/week is equivalent to 1 Credit

* 2 hours/week is allotted for off-class practical work

THIAGARAJAR COLLEGE OF ENGINEERING: MADURAI – 625 015
B.E Degree (Electronics and Communication Engineering) Program
SCHEME OF EXAMINATIONS
 (For the students admitted from the Academic Year 2014-2015)

SECOND SEMESTER

Course code	Name of the Course	Duration of Terminal Exam\ in Hrs.	Marks			Minimum Marks for Pass	
			Contiuous Assessment *	Terminal Exam **	Max. Marks	Terminal Exam	Total
THEORY							
14EC210	Engineering Mathematics II	3	50	50	100	25	50
14EC220	Passive Network Analysis and Synthesis	3	50	50	100	25	50
14EC230	Semiconductor Devices	3	50	50	100	25	50
14EC240	Materials Science	3	50	50	100	25	50
14EC250	Environment Science	3	50	50	100	25	50
THEORY CUM PRACTICAL							
14EC270	Digital Logic Circuit Design	3	50	50	100	25	50
PRACTICAL							
14EC280	Circuits and Devices Lab	3	50	50	100	25	50
14EC290	Workshop	-	100	-	100	-	50

THIRD SEMESTER

Course code	Name of the Course	Duration of Terminal Exam\ in Hrs.	Marks			Minimum Marks for Pass	
			Cont. uous Assessment *	Terminal Exam **	Max. Marks	Terminal Exam	Total
THEORY							
14EC310	Partial Differential Equations and Linear Algebra	3	50	50	100	25	50
14EC320	Problem Solving using Computers	3	50	50	100	25	50
14EC330	Electronic Circuit Design	3	50	50	100	25	50
14EC340	Signals and Systems	3	50	50	100	25	50
14EC350	Electromagnetics	3	50	50	100	25	50
THEORY CUM PRACTICAL							
14EC370	Microprocessors Architecture and Programming	3	50	50	100	25	50
PRACTICAL							
14EC380	Computer Programming Laboratory	3	50	50	100	25	50
14EC390	Electronic Circuit Design Laboratory	3	50	50	100	25	50

FOURTH SEMESTER

Course code	Name of the Course	Duration of Terminal Exam\ in Hrs.	Marks			Minimum Marks for Pass	
			Continuous Assessment *	Terminal Exam **	Max. Marks	Terminal Exam	Total
THEORY							
14EC410	Numerical Methods and Optimization	3	50	50	100	25	50
14EC420	Microcontrollers	3	50	50	100	25	50
15EC430	RF Transmission Lines and Passive Circuits	3	50	50	100	25	50
14EC440	Signal Processing	3	50	50	100	25	50
14EC450	Engineering Design	-	100	-	100	-	50
THEORY CUM PRACTICAL							
		3	50	50	100	25	50
PRACTICAL							
14EC480	Microcontroller Laboratory	3	50	50	100	25	50
14EC490	Signal Processing Laboratory	3	50	50	100	25	50
SPECIAL							
14EC4C1	Capstone Course I	-	100	-	100	-	50

FIFTH SEMESTER

Course code	Name of the Course	Duration of Terminal Exam\ in Hrs.	Marks			Minimum Marks for Pass	
			Continuous Assessment*	Terminal Exam**	Max. Marks	Terminal Exam	Total
THEORY							
14EC510	Data Communication Networks	3	50	50	100	25	50
14EC520	Digital CMOS Systems	3	50	50	100	25	50
15EC530	RF Active Circuits	3	50	50	100	25	50
14EC540	Analog and Digital Communication Systems	3	50	50	100	25	50
14ECPX0	Programme Elective I	3	50	50	100	25	50
THEORY CUM PRACTICAL							
14EC570	Image Processing	3	50	50	100	25	50
PRACTICAL							
14EC580	Data Communication Networking Laboratory	3	50	50	100	25	50
14EC590	Analog and Digital Communication Laboratory	3	50	50	100	25	50

SIXTH SEMESTER

Course code	Name of the Course	Duration of Terminal Exam\ in Hrs.	Marks			Minimum Marks for Pass	
			Continuous Assessment*	Terminal Exam**	Max. Marks	Terminal Exam	Total
THEORY							
14EC610	Management Theory and Practice	3	50	50	100	25	50
14EC620	Wireless Communication Systems	3	50	50	100	25	50
15EC630	Antenna and Wave Propagation	3	50	50	100	25	50
14ECPX0	Programme Elective II	3	50	50	100	25	50
14ECGX0	General Elective I	3	50	50	100	25	50
THEORY CUM PRACTICAL							
14EC670	Professional Communication	3	50	50	100	25	50
PRACTICAL							
14EC680	Microwave and Antenna Lab	3	50	50	100	25	50
14EC690	System Design and Testing Lab	3	50	50	100	25	50

SEVENTH SEMESTER

Course code	Name of the Course	Duration of Terminal Exam\ in Hrs.	Marks			Minimum Marks for Pass	
			Continuous Assessment*	Terminal Exam**	Max. Marks	Terminal Exam	Total
THEORY							
14EC710	Accounting and Finance	3	50	50	100	25	50
14EC720	Optical Communication Networks	3	50	50	100	25	50
14ECPX0	Programme Elective III	3	50	50	100	25	50
14ECPX0	Programme Elective IV	3	50	50	100	25	50
14ECGX0	General Elective II	3	50	50	100	25	50
14EC7C0	Capstone Course II	-	100	-	100	-	50
THEORY CUM PRACTICAL							
14EC770	ASIC Design	3	50	50	100	25	50
PRACTICAL							
14EC780	Elective Lab	3	50	50	100	25	50

EIGHTH SEMESTER

Course code	Name of the Course	Duration of Terminal Exam\ in Hrs.	Marks			Minimum Marks for Pass	
			Continuous Assessment*	Terminal Exam**	Max. Marks	Terminal Exam	Total
THEORY							
14ECPX0	Programme Elective V	3	50	50	100	25	50
14ECPX0	Programme Elective VI	3	50	50	100	25	50
14ECPX0	Programme Elective VII	3	50	50	100	25	50
PRACTICAL							
14EC880	Project	-	50	50	100	25	50

* Continuous Assessment evaluation pattern will differ from course to course and for different tests. This will have to be declared in advance to students. The department will put a process in place to ensure that the actual test paper follow the declared pattern.

** Terminal Examination will be conducted for maximum marks of 100 and subsequently be reduced to 50 marks for the award of terminal examination marks.

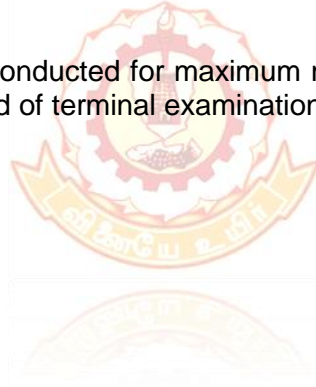

CURRICULUM AND DETAILED SYLLABI

FOR

B.E. / B.Tech. DEGREE PROGRAMME

FIRST SEMESTER

FOR THE STUDENTS ADMITTED IN THE

ACADEMIC YEAR 2014-15 ONWARDS

THIAGARAJAR COLLEGE OF ENGINEERING

(A Government Aided ISO 9001:2008 certified Autonomous Institution affiliated to Anna University)

MADURAI – 625 015, TAMILNADU

Phone: 0452 – 2482240, 41

Fax: 0452 2483427

Web: www.tce.edu

Credit Distribution

S.No.	Category	Credits	Institute Requirement	Department Core
1.	Humanities and Social Sciences	15	15	0
2.	Basic Sciences	26	5-11	15
3.	Engineering sciences	21	11-14	7
4.	Programme Core	63	0	63
5.	Programme Electives	21	0	21
6.	Project	12	0	12
7.	General Electives	6	6	0
Total Credits		164	37-46	118-127

- General electives are courses offered by different departments that do not have any prerequisites and could be of interest to students of any branch
- All students have to undertake co-curricular and extra-curricular activities that include activities related to NCC, NSS, Sports, Professional Societies, participation in identified activities which promote the growth of Departments and the College

BASIC SCIENCE COURSES		20-26
Engineering Mathematics-1 (Common)	3	
Engineering Mathematics-2 (Programme Specific)	3	
Engineering Mathematics-3 (Programme Specific)	3	
Engineering Mathematics-4 (Programme Specific)	3	
Engineering Mathematics-5 (Programme Specific)	3	
(As per the Individual programme Requirement)		
Physics	3	
Physics Laboratory	1	
Chemistry	3	
Chemistry Laboratory	1	
Department selected course (Programme Specific)	3	
(As per the individual programme Requirement)		
HUMANITIES AND SOCIAL SCIENCES COURSES		15
English Communication	3	
Professional Communication (Theory cum practical)	3	
Project Management	3	
Accounting and Finance	3	
Environment Science	3	
ENGINEERING SCIENCE COURSES		18-21
Basics of Civil and Mechanical Engineering	2	
Basics of Electrical & Electronics Engineering	2	
Engineering Graphics	3	
Engineering by Design	3	
Problem Solving using Computers	3	
Workshop	1	
Capstone Course –I	2	
Capstone Course-II	2	
Data Structures (CSE, IT, ECE)	3	
PROGRAMME CORE		63-72
(Foundation, System, Application)		
PROGRAMME ELECTIVES		21
GENERAL ELECTIVES		06
PROJECT		12
Total		164

THIAGARAJAR COLLEGE OF ENGINEERING: MADURAI – 625 015
B.E. / B.Tech. Degree Programme

COURSES OF STUDY
 (For the candidates admitted from 2014-15 onwards)

FIRST SEMESTER

Course Code	Name of the Course	Category	No. of Hours / Week			credits
			L	T	P	
THEORY						
14MA110	Engineering Mathematics I	BS	2	1	-	3
14PH120	Physics	BS	3	-	-	3
14CH130	Chemistry	BS	3	-	-	3
14EG140	English Communication	HSS	3	-	-	3
14ES150	Basics of Civil and Mechanical Engineering	ES	2	-	-	2
14ES160	Basics of Electrical and Electronics Engineering	ES	2	-	-	2
THEORY CUM PRACTICAL						
14ME170	Engineering Graphics	ES	2	-	2	3
PRACTICAL						
14PH180	Physics Laboratory	BS	-	-	2	1
14CH190	Chemistry Laboratory	BS	-	-	2	1
Total			17	1	6	21

BS : Basic Science
 HSS : Humanities and Social Science
 ES : Engineering Science

L : Lecture
 T : Tutorial
 P : Practical

Note:

1 Hour Lecture/Tutorial is equivalent to 1 credit

2 Hours Practical is equivalent to 1 credit

THIAGARAJAR COLLEGE OF ENGINEERING: MADURAI – 625 015**B.E. / B.Tech. Degree Programme****SCHEME OF EXAMINATIONS**

(For the candidates admitted from 2014-15 onwards)

FIRST SEMESTER

S.No.	Course Code	Name of the Course	Duration of Terminal Exam. in Hrs.	Marks			Minimum Marks for Pass	
				Continuous Assessment *	Terminal Exam **	Max. Marks	Terminal Exam	Total
THEORY								
1	14MA110	Engineering Mathematics I	3	50	50	100	25	50
2	14PH120	Physics	3	50	50	100	25	50
3	14CH130	Chemistry	3	50	50	100	25	50
4	14EG140	English Communication	3	50	50	100	25	50
5	14ES150	Basics of Civil and Mechanical Engineering	3	50	50	100	25	50
6	14ES160	Basics of Electrical and Electronics Engineering	3	50	50	100	25	50
THEORY CUM PRACTICAL								
7	14ME170	Engineering Graphics	3	50	50	100	25	50
PRACTICAL								
8	14PH180	Physics Laboratory	3	50	50	100	25	50
9	14CH190	Chemistry Laboratory	3	50	50	100	25	50

* CA evaluation pattern will differ from course to course and for different tests. This will have to be declared in advance to students. The department will put a process in place to ensure that the actual test paper follow the declared pattern.

** Terminal Examination will be conducted for maximum marks of 100 and subsequently be reduced to 50 marks for the award of terminal examination marks

	Category	L	T	P	Credit
14MA110 ENGINEERING MATHEMATICS - I	BS	2	1	0	3

Preamble

The driving force in engineering mathematics is the rapid growth of technology and the sciences. Matrices have been found to be of great utility in many branches of engineering applications such as theory of electric circuits, aerodynamics, mechanics and so on. Many physical laws and relations can be expressed mathematically in the form of differential equations. Based on this we provide a course in matrices, calculus and differential equations.

Prerequisite

Nil

Course Outcomes

On the successful completion of the course, students will be able to	
CO1: Find the inverse and the positive powers of a square matrix	Understand
CO2: Apply the concept of orthogonal reduction to diagonalise the given matrix	Apply
CO3: Find the radius of curvature, circle of curvature and centre of curvature for a given curve.	Understand
CO4: Determine the evolute and envelope for a given family of curves	Apply
CO5: Classify the maxima and minima for a given function with several variables, through by finding stationary points	Analyse
CO6: Apply Lagrangian multiplier method for finding maxima and minima of an unconstrained problem	Apply
CO7: Predict the suitable method to solve second and higher order differential equations	Apply

Assessment Pattern

Bloom's Category	Continuous Assessment Tests			Terminal Examination
	1	2	3	
Remember	10	10	10	20
Understand	30	30	30	20
Apply	40	40	40	50
Analyse	20	20	20	10
Evaluate	0	0	0	0
Create	0	0	0	0

Course Level Assessment Questions

Course Outcome 1 (CO1):

- Suppose an $n \times n$ matrices A and B have the same eigen values $\lambda_1, \lambda_2, \dots, \lambda_n$ with the same Independent eigen vectors X_1, X_2, \dots, X_n . Show that A = B.

- Find the 2x2 matrix having eigen values $\lambda_1=2$ and $\lambda_2=5$ with corresponding eigen vectors $X_1 = \begin{pmatrix} 1 \\ 0 \end{pmatrix}$, $X_2 = \begin{pmatrix} 1 \\ 1 \end{pmatrix}$.
- Find A^{-1} and A^4 for a given square matrix $A = \begin{pmatrix} 7 & 2 & -2 \\ -6 & -1 & 2 \\ 6 & 2 & -1 \end{pmatrix}$, using Cayley Hamilton theorem.
- Compute the eigenvalues and eigenvectors of $A = \begin{pmatrix} 7 & 2 & - \\ 1 & 1 & -2 \\ -1 & -2 & 1 \end{pmatrix}$

Course Outcome 2 (CO2):

- Transfer the given quadratic form $6x_1^2 + 3x_2^2 + 14x_3^2 + 4x_1x_2 + 4x_2x_3 + 18x_3x_1$ to canonical by an orthogonal transformation.
- Diagonalise the matrix $A = \begin{pmatrix} 8 & -6 & 2 \\ -6 & 7 & -4 \\ 2 & -4 & 3 \end{pmatrix}$
- Discuss when a quadratic form is singular. What is the rank then?

Course Outcome 3 (CO3)

- Predict the radius of curvature of the curve $x^3 + xy^2 - 6y^2 = 0$ at (3,3).
- Identify the centre of curvature of the curve $y = x^3 - 6x^2 + 3x + 1$ at (1,-1).
- Find the equation of the circle of curvature of the curve $y^3 + x^3 = 3axy$ at the point $\left(\frac{3a}{2}, \frac{3a}{2}\right)$.

Course Outcome 4 (CO4)

- Predict the evolute of the parabola $x^2 = 4ay$.
- Predict the envelope of the straight line $\frac{x}{a} + \frac{y}{b} = 1$, where a and b are parameters that are connected by the relation $a+b=c$.
- Is it possible to find the curvature of a straight line? Justify your answer.

Course Outcome 5 (CO5)

- Examine the extrema of $f(x, y) = x^2 + xy + y^2 + \frac{1}{x} + \frac{1}{y}$.
- Identify the saddle point and the extremum points of $f(x, y) = x^4 - y^4 - 2x^2 + 2y^2$.
- Analyse the extrema of the function $f(x, y) = x^2 - 2xy + y^2 + x^3 - y^3 + x^4$ at the origin

Course Outcome 6 (CO6)

- Apply Lagrangian multiplier method to find the shortest and the longest distances from the point (1,2,-1) to the sphere $x^2 + y^2 + z^2 = 24$.
- Exhibit the point on the curve of intersection of the surfaces $z=xy+5$ and $x+y+z=1$ which is nearest to the origin.
- The temperature at any point (x,y, z) in a space is given by $T = kxyz^2$, where k is a constant. Find the highest temperature on the surface of the sphere $x^2 + y^2 + z^2 = a^2$.

Course Outcome 7 (CO7)

1. Solve the equation $y'' + a^2y = \tan ax$ by the method of variation of parameters.
2. Compute the solution of the given equation $(x^2D^2 - 2xD - 4)y = 32(\log x)^2$.
3. Predict the solution of $((2x+3)^2D^2 - 2(2x+3)D - 12)y = 6$.
4. Solve the simultaneous equations $x'+2x - 3y = 5t$, $y'-3x + 2y = 2e^{2t}$.

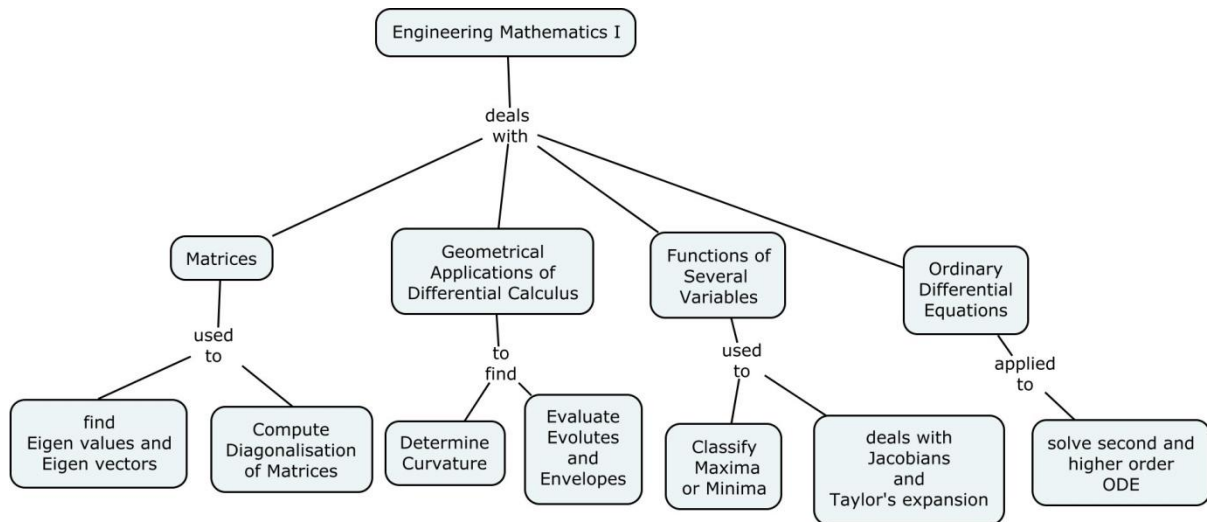
Concept Map**Syllabus**

MATRICES: Characteristic equation – Eigen values and Eigen vectors of a real matrix – Properties of Eigen values –Cayley Hamilton theorem- Orthogonal reduction of a symmetric matrix to diagonal form –Orthogonal matrices –Reduction of quadratic form by orthogonal transformation, Applications.

GEOMETRICAL APPLICATIONS OF DIFFERENTIAL CALCULUS: Curvature – Cartesian and Polar coordinates – Centre of curvature, Circle of curvature – Evolutes and Envelopes, Applications.

FUNCTIONS OF SEVERAL VARIABLES: Function of two variables – Partial derivatives – Total derivative – Change of Variables - Jacobians - Taylor's expansion – Maxima and Minima – Constrained Maxima and Minima by Lagrangian Multiplier method, Applications.

ORDINARY DIFFERENTIAL EQUATIONS: Linear differential equations of second and higher order with constant coefficients - Method of variation of parameters – Equations reducible to linear equations with constant coefficients: Cauchy's homogeneous linear equation and Legendre's linear equation - Simultaneous linear equations with constant coefficients. Applications.

Text Book

1. Kreyszig.E, "Advanced Engineering Mathematics", John Wiley & Sons. Singapore, 10th edition, 2012.
2. Grewal.B.S, Higher Engineering Mathematics, Khanna Publications, 42nd Edition, 2012.

Reference Books

1. Veerarajan.T, "Engineering Mathematics I", Tata McGraw Hill Publishing Co, New Delhi, 5th edition, 2006.
2. Kandasamy .P et.al. "Engineering Mathematics", Vol.I (4th revised edition), S.Chand &Co, New Delhi, 2000.

Course Contents and Lecture Schedule

Module No.	Topic	No.of Lectures
1	MATRICES	
1.1	Characteristic equation – Eigen values and Eigen vectors of a real matrix	2
1.2	Properties of Eigen values	1
	Cayley Hamilton theorem	2
	Tutorial	1
1.3	Orthogonal reduction of a symmetric matrix to diagonal form	2
1.4	Orthogonal matrices –Reduction of quadratic form by orthogonal transformation.	1
1.5	Applications	1
	Tutorial	1
2	GEOMETRICAL APPLICATIONS OF DIFFERENTIAL CALCULUS	
2.1	Curvature – Cartesian and Polar co-ordinates	2
2.2	Centre of curvature, Circle of curvature	2
	Tutorial	1
2.3	Evolutes	2
2.4	Envelopes.	2
2.5	Applications	1
	Tutorial	1
3	FUNCTIONS OF SEVERAL VARIABLES	
3.1	Function of two variables – Partial derivatives	1
3.2	Total derivative	1
	Tutorial	1
3.3	Change of Variables ,Jacobians	2
3.4	Taylor's expansion	1
3.5	Maxima and Minima	2
3.6	Constrained Maxima and Minima by Lagrangian Multiplier method	2
3.7	Applications	1
	Tutorial	1
4	ORDINARY DIFFERENTIAL EQUATIONS	
4.1	Linear differential equations of second and higher order with constant coefficients.	2
	Tutorial	1
4.2	Cauchy's homogeneous linear equation	1
4.3	Legendre's linear equation	1
4.4	Method of variation of parameters	1
4.5	Simultaneous linear equations with constant coefficients.	2
4.6	Applications	1
	Tutorial	1
	Total	44

Course Designers:

- | | | |
|----|-------------------------|--------------------|
| 1. | P. Subramanian | psmat@tce.edu |
| 2. | V. Gnanraj | vgmat@tce.edu |
| 3. | S. Jeya Bharathi | sjbmat@tce.edu |
| 4. | G Jothilakshmi | gjimat@tce.edu |
| 5. | A.P.Pushpalatha | appmat@tce.edu |
| 6. | M.Sivanandha Saraswathy | sivanandha@tce.edu |

14PH120 PHYSICS

Category	L	T	P	Credit
BS	3	0	0	3

Preamble

The course work aims in imparting fundamental knowledge of thermodynamics, quantum physics and optics which are essential in understanding and explaining engineering devices and measuring instruments. The objective of the course is to help students acquire a basic knowledge for thermal applications, electron microscopy techniques and fibre optic communication systems.

Prerequisite

Basic course (No prerequisite)

Course Outcomes

On the successful completion of the course, students will be able to

Assessment Pattern

CO1: Compute the theoretical efficiency of a Carnot's engine	Apply
CO2: Calculate the change in entropy in a thermal cycle	Apply
CO3: Explain the basic concept of quantum theory	Understand
CO4: Describe the working principle of SEM and TEM	Understand
CO5: Compare and contrast the properties and applications of laser and ordinary incandescent light	Analyse
CO6: Illustrate the principle of light transmission in a fibre and compare its advantages as a wave guide over the conventional co-axial cable	Analyse
CO7: Explain the basic principle, construction and working of optical fibre sensor	Understand

Bloom's Category	Continuous Assessment Tests			Terminal Examination
	1	2	3	
Remember	10	10	10	10
Understand	30	30	30	30
Apply	40	40	40	40
Analyse	20	20	20	20
Evaluate	0	0	0	0
Create	0	0	0	0

Course Level Assessment Questions**Course Outcome 1 (CO1):**

1. Show that the efficiency of an ideal heat engine depends only on the temperature of the source and sink.
2. Compute the efficiency of a Carnot's engine working between the steam point and the ice point.
3. A Carnot's engine is operated between two reservoirs at temperature of 450K and 350K. If the engine receives 1000 calories of heat from the source in each cycle. Calculate the amount of heat rejected to the sink and work done by the engine in each cycle.

Course Outcome 2 (CO2):

1. Compute the change in entropy when 5 kg of water at 100°C is converted into steam at the same temperature. (Latent heat of vaporisation=540cal/g)
2. Show that the area of the temperature-entropy diagram of a Carnot's cycle is the useful work done per cycle.
3. One mole of a gas expands isothermally to four times its volume. Calculate the change in entropy in terms of gas constant.

Course Outcome 3 (CO3):

1. Describe Planck's law of black body radiation.
2. Summarize the physical significance of wave function.
3. Explain Compton Effect and derive an expression for the wavelength of the scattered photon.

Course Outcome 4 (CO4):

1. Explain the construction and working of TEM.
2. Explain the wave-particle duality of matter and obtain an expression for de Broglie wavelength.
3. Describe the construction and working of SEM.

Course Outcome 5 (CO5):

1. Find the ratio of population of two energy states in a Laser, the transition between which is responsible for the emission of photons of wavelength 6893A at a temperature of 300K. Comment on the type of emission based on the ratio of population.
2. Analyse the role of mixture of gases for a CO₂ laser and predict the working of the laser without Helium gas in the mixture.
3. Differentiate between CO₂ laser and NdYAG Laser with respect to their construction and energy level diagram.

Course Outcome 6 (CO6):

1. Compare and contrast the material properties of core and cladding
2. Identify the major advantages of optical fibre communication system over conventional communication systems
3. Draw the refractive index profile of step index and graded index fibres and comment on the advantages of graded index fibre based on refractive index profile.

Course Outcome 7 (CO7)

1. Define a sensor with an example.
2. Explain the classification of fibre optic sensors based on their working principle.
3. Explain the principle and working of temperature sensor

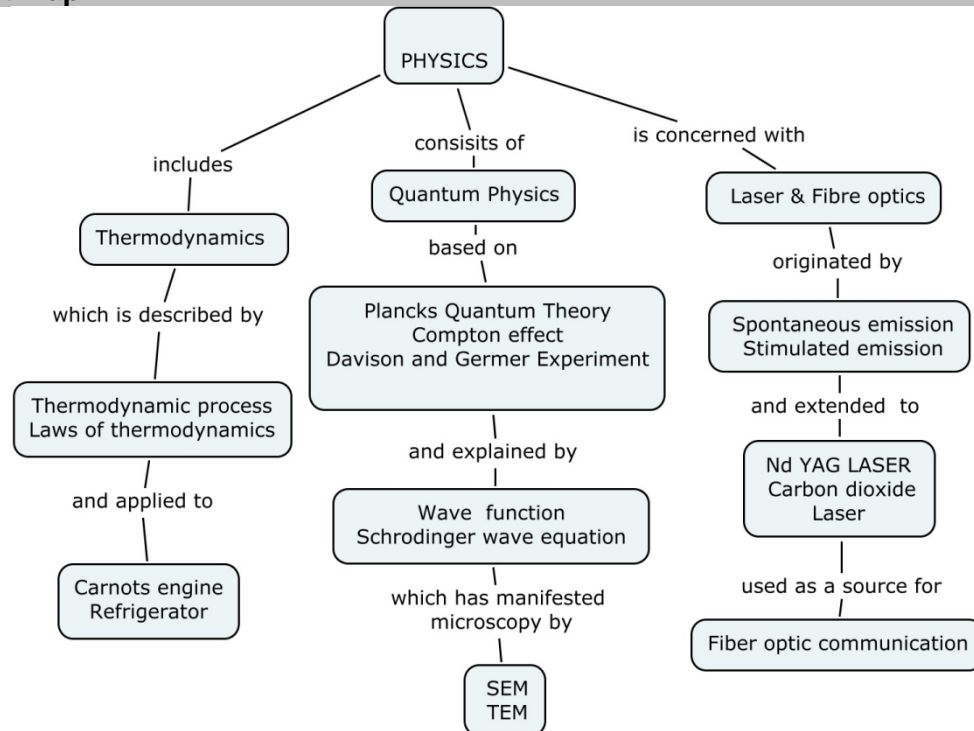
Concept Map**Syllabus****Thermodynamics**

Introduction to thermodynamics-Thermodynamic process-Work done in isothermal and adiabatic process- First and second law of thermodynamics- Carnot's engine-Refrigerator, Temperature-Entropy diagram-Change in entropy in reversible and irreversible process-Entropy of a perfect gas. Application: Otto cycle- Internal Combustion engine.

Quantum Physics

Planck's quantum theory of blackbody radiation-Compton effect-De-Broglie Hypothesis-Davison & Germer experiment-wave function and its properties-Uncertainty principle-Schrodinger wave equation-Time dependent and time independent equations-particle in a box.

Application: Scanning Electron Microscope-Transmission Electron Microscope

Laser and Fibre Optics

Fundamentals of laser-Spontaneous and Stimulated emission-Laser action-characteristics of laser beam-Einstein coefficients-Nd-YAG laser, CO₂ laser-applications of laser- Holography Fibre Optics-Principle and propagation of light in Optical fibre-Numerical aperture-Acceptance angle-Classification of Optical fibre based on material, refractive index and mode-Fibre Optic communication system.

Application: Fibre Optic sensors- temperature, and displacement sensors.

Text Book

1. Paul G Hewitt, "Conceptual Physics", 12th Edition Pearson Higher Education Pvt. Ltd., 2014.
2. Gour R.K. and Gupta S.L., "Engineering Physics", 8th Edition Dhanpat Rai Publications, 2006

Reference Books

1. Arthur Beiser, " Concepts of Modern Physics", McGraw Hill Education(India) Pvt Limited ,6th Edition, 2003
2. Stephen Blundell, "Concepts in Thermal Physics", Oxford University Press, 2nd Edition 2010.
3. Gerd keiser, " Optical fiber communications", Tata Mc Graw Hill Pvt Ltd, 4th Edition 2008.

Course Contents and Lecture Schedule

Module No.	Topic	No. of Lectures
1.	Thermodynamics	
1.1	Introduction to thermodynamics-Thermodynamic processes	2
1.2	Work done in isothermal and adiabatic process	2
1.3	First and second law of thermodynamics	2
1.4	Carnot's engine- theoretical efficiency expression-Refrigerator	2
1.5	Temperature-Entropy diagram	1
1.6	Change in entropy in reversible and irreversible process	2
1.7	Entropy of a perfect gas	2
1.8	Application: Otto cycle- Internal Combustion engine.	2
2.	Quantum Physics	
2.1	Planck's quantum theory of blackbody radiation	2
2.2	Compton effect- derivation	3
2.3	Davisson & Germer experiment	2
2.4	Wave function and its properties-Uncertainty principle	2
2.5	Schrodinger wave equation-Time dependent and time independent equations	2
2.6	Particle in a box - Problems	2
2.7	Application: Scanning Electron Microscope-Transmission Electron Microscope	2
3.	Laser and Fibre Optics	
3.1	Fundamentals of laser, Spontaneous and Stimulated emission	1
3.2	Laser action-characteristics of laser beam	2
3.3	Einstein coefficients	1
3.4	Nd-YAG laser	1
3.5	CO ₂ laser	1
3.6	Applications of laser- Holography	1
3.7	Principle and propagation of light in Optical fibre	1
3.8	Numerical aperture-Acceptance angle	2
3.9	Classification of Optical fibre based on material, refractive index and mode	2
3.10	Fibre Optic communication system	1
3.11	Application: Fibre Optic sensors- temperature, and displacement sensor	2

Total **42**

Course Designers:

- | | |
|-------------------------|----------------|
| 1. Dr.R.Vasuki | rvphy@tce.edu |
| 2. Mr. A.L.Subramaniyan | alsphy@tce.edu |
| 3. Mr. D.Ravindran | drphy@tce.edu |

14CH130 CHEMISTRY

Category	L	T	P	Credit
BS	3	0	0	3

Preamble

The objective of this course is to bestow better understanding of basic concepts of chemistry and its applications on diverse engineering domains. It also imparts knowledge on properties of water and its treatment methods, Engineering materials and its protection from corrosion, Energy storage technologies, properties of fuels and combustion. This course also highlights criteria behind selecting materials for various engineering applications and their characterization.

Prerequisite

Basic Course (no prerequisite)

Course Outcomes

On the successful completion of the course, students will be able to

CO 1. Estimate the hardness of water	Apply
CO 2. Identify suitable water treatment methods	Analyze
CO 3. Describe the components and working of energy storage devices	Understand
CO 4. Illustrate control methods for various forms of corrosion	Apply
CO 5. Enumerate the quality of fuels from its properties	Remember
CO 6. Outline the important features of fuels	Analyze
CO 7. Select appropriate materials for specific applications	Apply

Assessment Pattern

Bloom's Category	Continuous Assessment Tests			Terminal Examination
	1	2	3	
Remember	20	20	20	20
Understand	40	30	30	30
Apply	40	40	40	40
Analyze	0	10	10	10
Evaluate	0	0	0	0
Create	0	0	0	0

Course Level Assessment Questions**Course Outcome 1 (CO1):**

- Differentiate temporary and permanent hard water.
- 50 ml of given water sample consumed 18 ml of EDTA during titration using EBT indicator. 25 ml of same EDTA consumed by 50 ml of standard hard water containing 1 mg of pure CaCO_3 per ml. Calculate the hardness of given water samples in ppm.
- Describe the essential characteristics of drinking water.

Course Outcome 2 (CO2):

- Compare the mechanisms involved in ion exchange and zeolite methods of water treatment.
- Appraise the treatment steps followed in municipal water supply.
- Criticize the internal treatment methods of water.

Course Outcome 3 (CO3):

1. Describe the working of lithium ion battery with the help of electrode reactions.
2. Demonstrate the advantages of fuel cell over conventional batteries.
3. Explain the types of battery.

Course Outcome 4 (CO4)

1. Illustrate the different forms of corrosion
2. Collect and explain the factors which influence the corrosion.
3. Exhibit the various forms of corrosion control methods

Course Outcome 5 (CO5)

1. Define the calorific value of the fuel
2. Describe the cetane and octane numbers of the fuel.
3. List the characteristics of good fuel

Course Outcome 6 (CO6)

1. Assess the quality of coal by performing proximate and ultimate analysis
2. Calculate the minimum volume of air required for the complete combustion of 1 m³ of gaseous fuel containing the following composition by volume. CO: 23%; H₂:12%; CH₄: 3%; CO₂: 5%; N₂: 55%; and O₂: 2%.
3. Compare: Liquefied petroleum gas and bio gas.

Course Outcome 7 (CO7)

1. Explicate the characteristics of good refractory material.
2. Demonstrate the preparation of nano materials by sol-gel method.
3. Exhibit the applications of polymer composites.

Concept Map

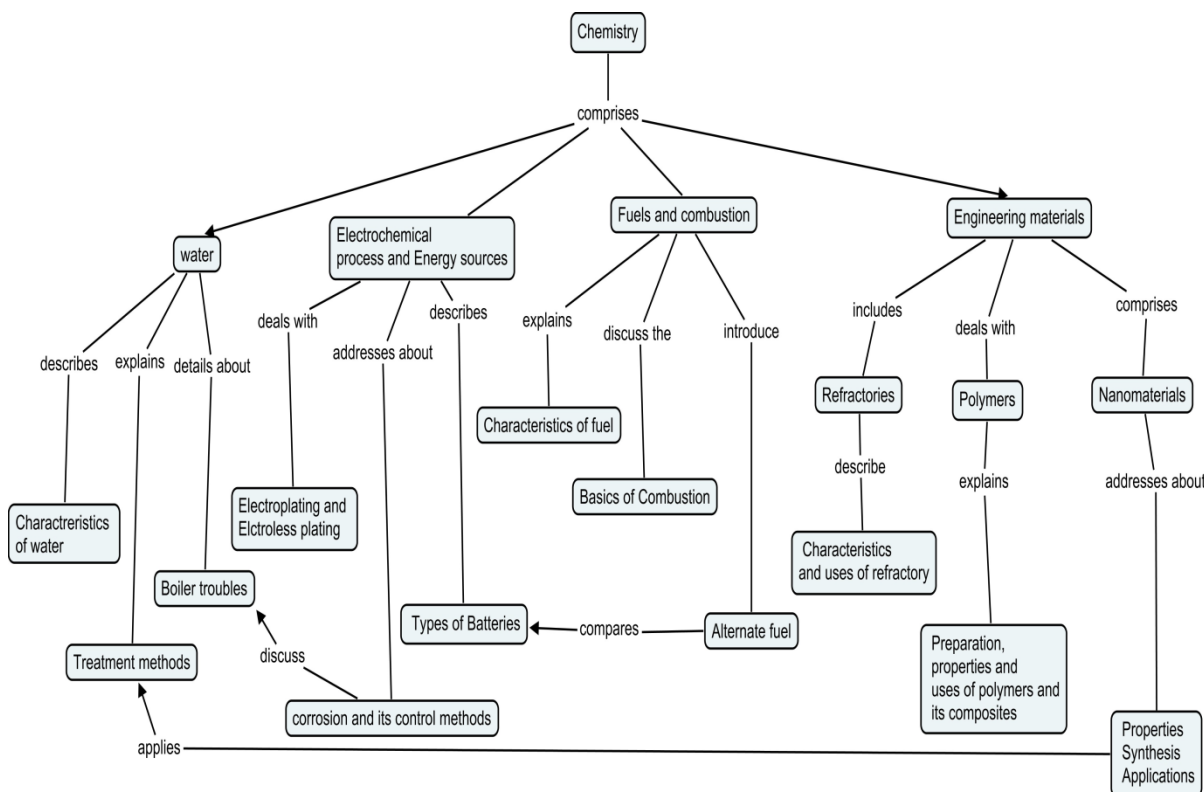

Syllabus

WATER: Standards for drinking water, Hardness. Softening of water: External and Internal treatments of water, Boiler troubles, Methods of treatment of municipal water .

ELECTROCHEMICAL PROCESSES AND ENERGY SOURCES: Introduction - Electroplating – Principle- Significant parameters and applications-PCB manufacturing-Electroless plating. **Batteries** –Primary and secondary batteries – Characteristics-Examples. Fuel cells - Classification and working principles. **Corrosion:** Principle-types-forms and control methods.

FUELS AND COMBUSTION: Fuels-Introduction- classification of fuels- calorific values - analysis of coal. **Combustion** –principle- calculation of fuel and air ratio- knocking characteristics - flue gas analysis –gaseous fuels - alternate fuels.

ENGINEERING MATERIALS: Refractories: Definition, characteristics, classification, properties-requisites of good refractory and their uses – **Polymers:** classification-Industrially important polymers – PE, PET, PVC – PU – nylon – epoxy resins – Bakelite-preparation properties and uses-conducting polymer-bio-polymer-polymer composites- **Nanomaterials:** Size-dependent properties – synthesis by physical and chemical methods –applications-future perspectives.

Text Book

1. Jain & Jain, “ Engineering Chemistry”, Dhanpat Rai publishing Company (P) Ltd, NewDelhi, 15th Edition, 2008.

Reference Books

1. S.S. Dara and S.S.Umare, “A Textbook of Engineering Chemistry”, S.Chand & Company, 12th Edition, Reprint, 2013.
2. V R Gowariker, N V Viswanathan and Jayadev Sreedhar, “Polymer Science” New age International Publisher, 2012.
3. Charles P.Poolejr and Frank J.Owens, “Introduction to Nanotechnology”, Wieli-India, 2008.

Course Contents and Lecture Schedule

Module No.	Topic	No. of Lectures
1.0	Water	
1.1	Introduction: importance of water, standards for drinking water, physical, chemical & biological parameters. (WHO, BIS & ICMR standards)	1
1.2	Alkalinity (principle only) ,Hardness of water – types, units,	1
1.3	Determination of hardness by EDTA method and problems	2
1.4	Softening of water: External treatment methods: Lime-soda process (concept only), zeolite process,	1
1.5	ion exchange process, reverse osmosis, electro dialysis	2
1.6	Solar and multistage flash distillation , nanofiltration	1
1.7	Boiler trouble: scale and sludge formation, boiler corrosion, priming and foaming, caustic embrittlement,	2
1.8	Internal treatment methods: Carbonate, Phosphate, Colloidal, Calgon conditioning,	1
1.9	municipal water treatment	1
2.0	Electrochemical process and Energy sources	
2.1	Electrochemistry- introduction-Electroplating- Definition, Principles- Significant parameters	2
2.2	Nickel and Chromium electroplating	1
2.3	Electroless plating –PCB manufacturing	1
2.4	Corrosion- definition, mechanism, forms of corrosion	2

Module No.	Topic	No. of Lectures
2.5	Factors influencing corrosion and corrosion control methods	2
2.6	Batteries- Definition, types-dry cell, lead acid and lithium batteries	2
2.7	Fuel cells- principle, types and applications. (H ₂ O ₂ fuel cell)	1
3.0	Fuels and combustion	
3.1	Introduction- Classification of fuels	1
3.2	Calorific Values- Theoretical calculation using Dulong's formula	1
3.3	Coal – classification- Analysis of coal- Proximate and Ultimate analysis	2
3.4	Refining of petroleum- Knocking characteristics-Octane and Cetane numbers	1
3.5	Natural gas- Liquefied petroleum gas- producer gas-bio gas- alternate fuels- power alcohol- bio diesel	2
3.6	Combustion- calorific intensity- SIT- Calculation of minimum quantity of air required for combustion	2
3.7	Flue gas analysis	1
3.8	Gaseous fuels	1
3.9	Alternate fuels	1
4.0	Engineering materials	
4.1	Refractories: Definition-physical and chemical characteristics- classification, properties-requisites of good refractory and their uses	2
4.2	Polymers: classification-Industrial important polymers – PE, PET, PVC – PU– nylon – epoxy resins- Bakelite- preparation properties and uses	2
4.3	conducting polymer mechanism -bio-polymer-polymer composites	1
4.4	Nanomaterials: Size-dependent properties – synthesis by physical (laser ablation, PVD) and	2
4.5	chemical methods (solgel, hydro thermal) - applications-future perspectives	2
Total number of Lectures		44

Course Designers:

- | | | |
|----|---------------------|-----------------------------|
| 1. | Dr.K.Radha | hodchem@tce.edu |
| 2. | Dr. M.Kottaisamy | mmksami@tce.edu |
| 3. | Mrs.J.Shanmugapriya | shanmugapriya@tce.edu |
| 4. | Mr.S.Rajkumar | rajkumarsubramaniam@tce.edu |

14EG140	ENGLISH COMMUNICATION	Category	L	T	P	Credit
		HSS	2	1	0	3

Preamble

English (14EN140) is a life skill course necessary for all students of Engineering and Technology. The course work aims at developing communication skills in English essential for understanding and expressing the ideas in different social, academic and professional contexts. The outcome of the course is to help the students acquire the language skills of listening, speaking, reading and writing competency in English language thereby making them competent and employable in the globalised scenario.

Prerequisite

No prerequisite

Course Outcomes

On the successful completion of the course, students will be able to

CO1. listen, understand and respond to others in different situations Apply

CO2. speak correctly and fluently in different situations using appropriate communication strategies. Create

CO3. read and comprehend a variety of texts adopting different reading skills Analyze

CO4. write with clarity in simple, apt and flawless language with coherence and cohesion Create

CO5. use their communicative competency with precision and clarity in the context of science and technology Create

CO6. be interpersonal and proactive in using language confidently and effectively for personal and profession growth Create

Assessment Pattern

Bloom's Category	Continuous Assessment Tests			Terminal Examination
	1	2	3	
Remember	10	10	10	10
Understand	15	15	15	15
Apply	40	40	40	40
Analyse	15	15	15	15
Evaluate	-	-	-	-
Create	20	20	20	20

Course Level Assessment Questions**Course Outcome 1 (CO1):**

4. Tested by way of assignments like – listening to short speeches of contexts - general and technical
5. Answering questions – objective and descriptive
6. Note taking

Course Outcome 2 (CO2):

1. Tested by way of assignments like role play, mini presentation, self-introduction, situational conversation and one-to-one debate
2. Write down an imaginary dialogue between a father and a son about his/her fresh college experience. (in five exchanges, not more than 150 words)

3. Choose the right option that at best fits in the blanks (Mention A or B or C or D only)

They are to ____ a question paper to identify the moral ____ of the young candidates.

A. /prɪvɪnt/-/kærɪktə/ B. /sɛt/-/kɒndɪkt/ C. /prɪpɛə/-/kɒndɪkt/ D. /prezəns/-/kəʊd/

3. Read the following phonemic sentence and answer the question below:

/ðeə/ ɪz nəʊ kɒk ɪn ðə klɑ:sru:m/

What is unavailable in the learning place?

Course Outcome 3 (CO3):

1. Read the following passage and answer the following questions.

A passage from the context of science and technology/current issues will be given followed by different types of questions/exercises like:

- Descriptive questions for eliciting short answers
- True or False
- Sentence Completion
- Objective type
- Synonyms /meaning of the words in the text

2. Read the passage given under Q.No. 1a and 'make notes' (Not exceeding 100 words).

3. Read the passage given under Q.No.1a and write a summary (Not exceeding 100 words).

Course Outcome 4 (CO4):

1. Rewrite the following sentence using the appropriate modal auxiliary

The variation in reading is to be noted down every minute compulsorily for the first five minutes.

2. Expand the nominal compounds: 1. Credit Card 2. Newspaper Glasses

3. Complete the following: The function of a mini drafter -----

4. What is meant by a topic sentence?

5. Write a set of recommendations to save electric power.

Course Outcome 5 (CO5):

1. Analyse and interpret the following graphic data in about 100 words:

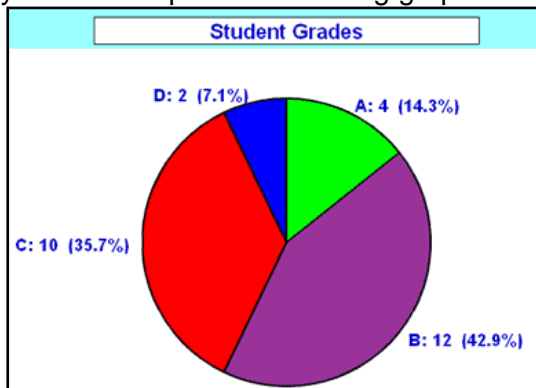

2. Write a basic definition of an MP3 player.

3. Establish cause and effect relationship for the following:

The trade imbalance is likely to rise again in 2015. A new set of policy actions will be required soon.

Course Outcome 6 (CO6):

1. Write a letter to the HR Manager, TCS, Chennai, requesting him to grant permission for your In-plant Training during your summer vacation.

2. Write a paragraph in about 100 words on "The Impact of Technology on Nature"

3. Prepare a set of 10 instructions on how to draw money from an ATM.

Concept Map

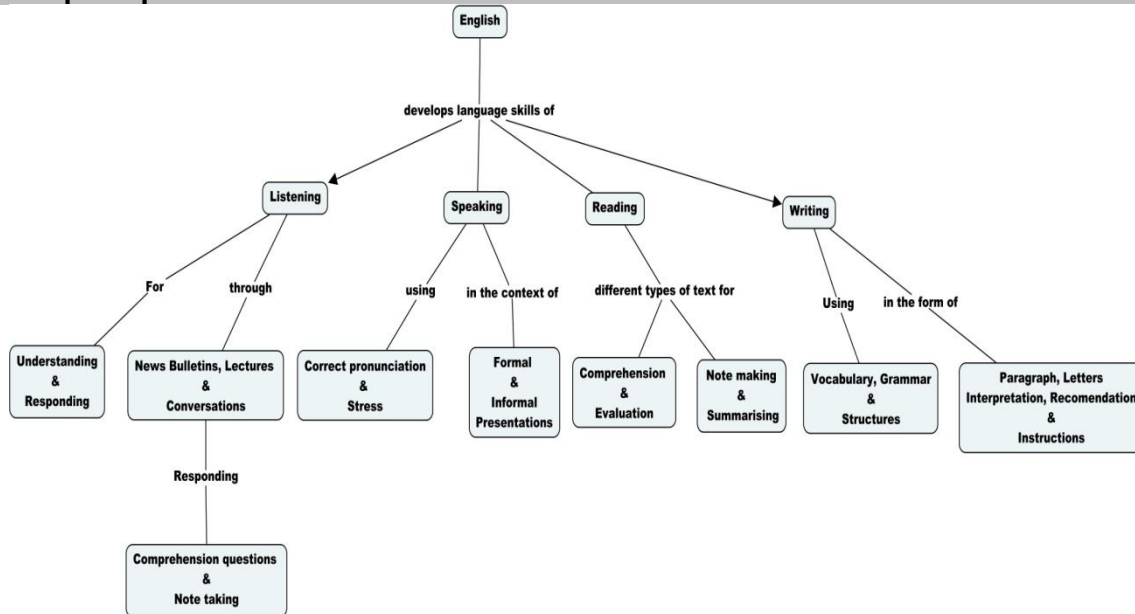

Syllabus

Listening

Listening to news bulletins, lectures and conversations; answering comprehension questions; active listening; note-taking

Speaking

Pronunciation, Syllable and Stress; Contracted forms, Courtesy words; Situational conversation, One-to one debate and Mini presentation on extensive reading and Dailies.

Reading

Skipping, Scanning and Skimming; Reading for information and pleasure; Study skills – Comprehension, Note-making and Summarising

Writing

Vocabulary : Word analysis, Parts of Speech (Nouns, Verbs, Adjectives, Adverbs Articles, Prepositions, Conjunctions); Sentences Types (Affirmative, Negative, Interrogative, Imperative, Exclamatory) ; Sentence Structure (Subject Verb Agreement, Tenses, Voices, Modals, Conditionals, Relative clauses, Reported Speech); Dialogue Writing, Notions (Nominal Compounds, Definition, Classification, Cause and Effect, Purpose and Function) Paragraph Writing: Compare and Contrast, Descriptive; Formal Letters; Interpretation of Graphics; Instructions and Recommendations.

Text Book

Study Material prepared by the Department of English

Reference Books

1. Department of English, Anna University, Mindscapes: English for Technologists and Engineers, Orient Blackswan, Chennai, 2012
2. Dhanavel, S.P. English and Communication Skills for Students of Science and Engineering, Orient Blackswan, Chennai, 2011
3. Murphy, Raymond English Grammar in Use with Answers: Reference and Practice for Intermediate Students, Cambridge : CUP, 2004
4. Jones, Daniel. An English Pronouncing Dictionary, Cambridge: CUP, 2006
5. Prasad, Hari Mohan , Sinha, Uma Rani , Objective English for Competitive Examinations, Tata McGraw-Hill: Noida, 2010
6. Thomson, A.J. and Martinet, A.V. A Practical English Grammar, OUP, New Delhi:1986
7. Lewis, Norman, Word Power Made Easy, Goyal Publishers, New Delhi: 2004

Extensive Reading

1. A compilation of select texts (extracts) from different disciplines.(for speaking activities)

Course Contents and Lecture Schedule

Module No.	Topic	No. of Lectures
1.	Introduction	1
2.	Listening to News, Lectures, Conversations - Practice	1
3.	Comprehension Exercises	1
4.	Active Listening and Note-taking	1
5.	Introduction to Phonemes	1
6.	Syllables and Stress	1
7.	Contracted Forms, Courtesy Words	1
8.	Situational Conversation, Telephonic Conversation	1
9.	Reading - Skimming, Skipping and Scanning	1
10.	Note Making and Summarizing	1
11.	Dialogue Writing	1
12.	Vocabulary - Word Analysis, Parts of Speech	1
13.	Types of Sentences	1
14.	Tutorial	1
15.	Presentation Skills (Activity)	2
16.	Reading Comprehension	2
17.	Subject Verb Agreement	1
18.	Tenses	2
19.	Voices	1
20.	Modals	1
21.	Conditions	1
22.	Relative Clause	1
23.	Reported Speech	1
24.	Formal Letter Writing	1
25.	Instruction Writing	1
26.	Tutorial	1
27.	Nominal Compounds	1
28.	Definition and Classification	1
29.	Cause and Effect	1
30.	Purpose and Function	1
31.	Paragraph Writing	2
32.	Recommendation Writing	1
33.	Interpretation of Graphics	2
34.	Spoken Assignment	3
35.	Tutorial	1
36.	Revision	2
37.	Feedback	1
	Total	45

Course Designers:

1	Dr.T.Sadasivan	sadasivan@tce.edu
2	Dr.S.Rajaram	sreng@tce.edu
3	Dr.A.Tamilselvi	tamilselvi@tce.edu
4	Mr.Vinoth.R	vino@tce.edu
5	Ms.R.K.Jai Shree Karthiga	jai@tce.edu

14ES150

**BASICS OF CIVIL AND
MECHANICAL ENGINEERING**

Category	L	T	P	Credit
ES	2	0	0	2

A. BASICS OF CIVIL ENGINEERING**Preamble**

This course will create awareness on fundamental knowledge on various domains of Civil Engineering

Prerequisite

- No prerequisite courses

Course Outcomes

On the successful completion of the course, students will be able to:

CO1:	Identify the branches of Civil Engineering and roles of a Civil Engineer	Understand
CO2:	Explain the properties and uses of building materials, Concept of green building	Understand
CO3:	Identify and explain the functions of various components of a residential building and building safety devices	Understand
CO4:	Explain the properties and classifications of soils and appropriate foundation for different soil conditions	Understand
CO5:	Identify the various sources of water and need for rain water harvesting	Understand
CO6:	Explain the various stages of works involved in water supply and sewerage projects.	Understand
CO7:	Classify roads and explain the importance of signalling	Understand

Assessment Pattern

Bloom's Category	Continuous Assessment Tests			Terminal Examination
	1	2	3	
Remember	20	20	--	20
Understand	30	30	--	30
Apply	---	---	---	---
Analyse	---	---	---	---
Evaluate	---	---	---	---
Create	---	---	---	---

CAT 3 – ASSIGNMENT (GROUP PRESENTATION)**Course Level Assessment Questions****Course Outcome 1 (CO1):**

- List the various branches of Civil Engineering
- Compare the roles of Structural and Environmental Engineers
- Discuss the various functions of a Civil Engineer

Course Outcome 2 (CO2):

- Discuss the properties of a building stone
- Mention the types of cement
- Compare PCC and RCC and mention the applicability of each

Course Outcome 3 (CO3)

1. Draw the cross section through a wall and explain the functions of various components
2. Compare arches and lintels
3. Write the purpose of DPC in buildings

Course Outcome 4 (CO4)

1. Define foundation and mention its various types
2. Enumerate the various engineering properties of soil
3. Explain the situations requiring deep foundations.

Course Outcome 5 (CO5)

1. Explain the various sources of water
2. Draw and explain the hydrological cycle
3. Write the need for preserving water, mentioning its methods

Course Outcome 6 (CO6)

1. Define per capita demand
2. Explain the necessity for treatment of water
3. Explain the need for sewerage

Course Outcome 7 (CO7)

1. Discuss the classification of roads
2. List the various modes of transportation
3. Write the need and importance for signalling in roads.

Concept Map

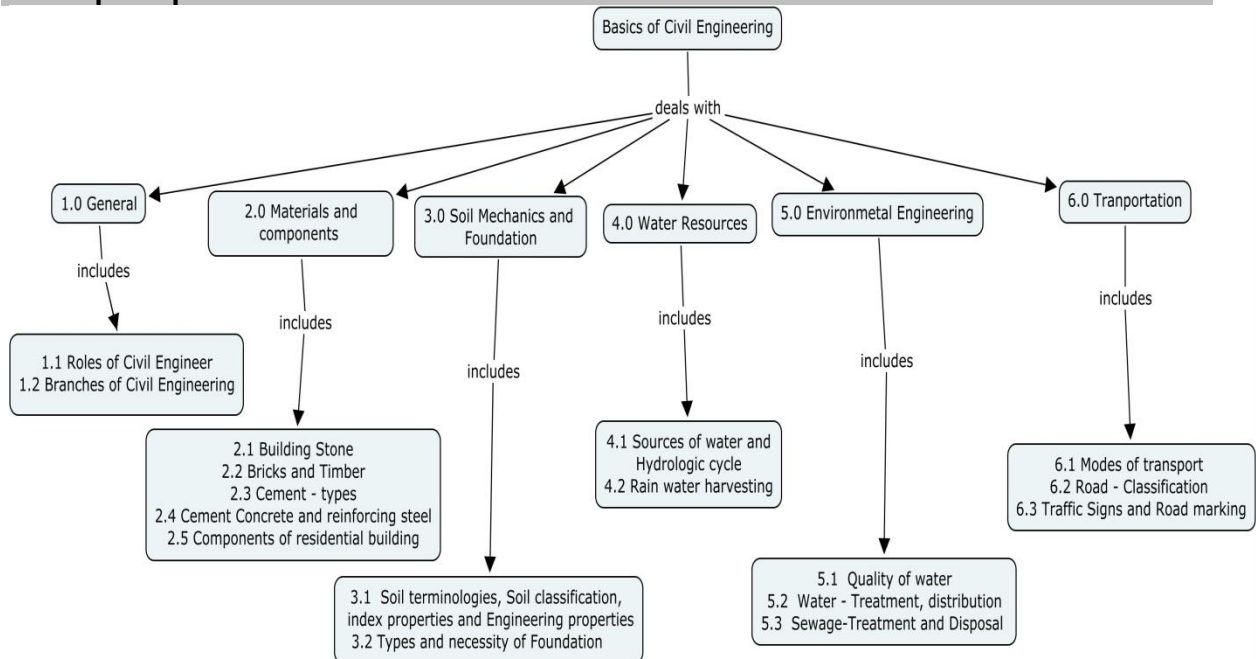

Syllabus

General: Introduction – Functions and role of Civil Engineer- Branches of Civil Engineering.

Materials and Components: Materials – Properties, classification and characteristics of building stones, bricks, timber, cement and cement concrete, reinforcing steel- Components of residential building. Green building concepts and building safety devices. **Soil Mechanics and Foundation:** Geological cycle – Soil classification –Engineering properties. Foundation – Types and necessity. **Water Resources:** Sources of water – Hydrologic cycle – Rain water harvesting – importance – methods of rain water harvesting. **Environmental Engineering-** Water demand estimation – Sources of water – Quality of water – Treatment of water- Water distribution. Sewerage – need and importance – collection, treatment and disposal of sewage – Septic tanks. **Transportation:** Modes of transport – types. Roads – Classification of rural and urban roads. Traffic signs and road marking – Traffic signals.

Text Book:

1. Lecture Notes prepared by TCE Civil Engineering Faculty

Reference Books

1. G.Shanmugam and M.S.Palanichamy, "Basics of Civil and Mechanical Engineering", Tata McGraw Hill Publishers, New Delhi, 2014
2. T. Jha and S.K. Sinha, "Construction and Foundation Engineering" , Khanna publishers, Delhi, 2003
3. Ahuja and Birdi, , "Fundamentals of Building Construction" Dhanpat Rai and sons Delhi, 2000
4. Rangwala and S.B.Patel, "Engineering materials", Charotar publishing house, Anand, 2002
5. S.K. Garg, "Water Supply Engineering", Khanna publishers, Delhi, 2005
6. S.K. Garg, "Sewage Disposal and Air Pollution Engineering", Khanna publishers, Delhi, 2005
7. Khanna and Justo, "Highway Engineering", New Chand and Bros, Roorkee, 2000

Course Contents and Lecture Schedule

Module No.	Topic	No. of Lectures
1.0	General	
1.1	Roles of Civil Engineer	1
1.2	Branches of Civil Engineering	
2.0	Materials and Components	
2.1	Building stone – properties, types, characteristics and uses	1
2.2	Bricks and timber - properties, types, characteristics and uses	1
2.3	Cement- properties, types, characteristics and uses	1
2.4	Cement concrete and reinforcing steel - properties and uses	
2.5	Components of residential buildings – purpose	2
3.0	Soil Mechanics and Foundation	
3.1	Geological Cycle- Soil classification, engineering properties	1
3.2	Types and necessities of foundation	1
4.0	Water Resources	
4.1	Sources of water and hydrologic cycle	1
4.2	Rain water harvesting- importance and methods	1
5.0	Environmental Engineering	
5.1	Water demand estimation, quality and treatment of water	1
5.2	Methods of water distribution	1
5.3	Sewerage- need and importance, collection, treatment and disposal-Septic tank	1
6.0	Transportation	
6.1	Modes of transport	1
6.2	Road classification	
6.3	Traffic signs and road marking	2
Total periods		16

Course Designers:

- | | | |
|----|-------------------|----------------|
| 1. | Dr. T. Vel Rajan | tciv@tce.edu |
| 2. | Dr. S. Nagan | snciv@tce.edu |
| 3. | Dr. R. Velkennedy | rvkciv@tce.edu |
| 4. | Dr. G. Chitra | gcciv@tce.edu |
| 5. | Dr. T. Baskaran | tbciv@tce.edu |
| 6. | Dr. R. Ponnudurai | rpciv@tce.edu |

B. BASICS OF MECHANICAL ENGINEERING

Preamble

Basic Mechanical Engineering gives the fundamental ideas in the areas of engineering design, manufacturing and thermal engineering. An engineer needs to understand the design procedures, manufacturing techniques and working principle of an engineering component.

Prerequisite

NIL

Course Outcomes

On successful completion of the course, students will be able to

CO1: Describe the steps involved in component design and transmission systems	Understand
CO2: Explain the manufacturing processes such as casting, forming, joining, and machining	Understand
CO3: Describe the Functions of Prime movers, working of IC engines and refrigerator	Understand
CO4: Explain the various safety practices in industries and personal protective elements	Understand

Assessment Pattern

Bloom's Category	Continuous Assessment Tests			Terminal Examination
	1	2	3	
Remember	40	40	Assignment evaluation	40
Understand	60	60		60
Apply				
Analyse				
Evaluate				
Create				

Course Level Assessment Questions

Course Outcome 1 (CO 1):

1. Describe the evolution of mechanical engineering
2. State the need for design
3. Define stress

Course Outcome 2 (CO 2):

1. What is rolling?
2. What is the need of metal joining
3. State the applications of casting.

Course Outcome 3 (CO 3):

1. State the function of prime mover.
2. Explain the vapour compression refrigeration system
3. Compare the two stroke and four stroke engine

Course Outcome 4 (CO 4):

1. State the various precautions are to taken by the welder
2. Explain the various personal safety practices in industries with reference to OSHA

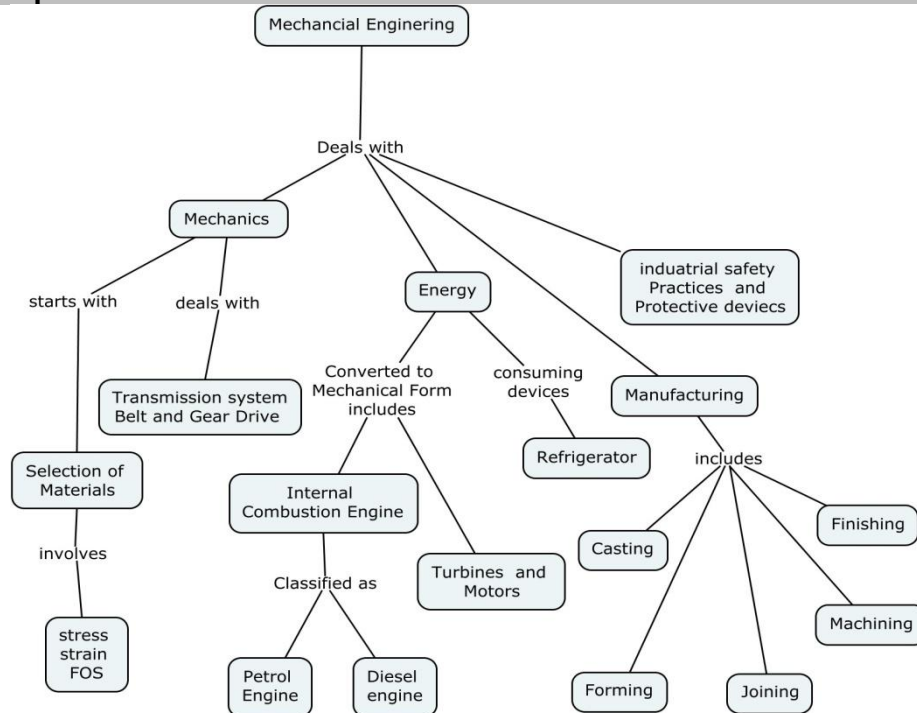
Concept Map**Syllabus**

History and evolution of Mechanical Engineering

Steps of design procedure –Materials for engineering components, stress, strain, Factor of safety. Transmission systems- Belt and gear drives

Manufacturing processes – Types of manufacturing industries and manufacturing systems, foundry - green sand mould casting. Metal forming - forging, rolling, extrusion, drawing, Metal joining – Resistance Arc welding and Gas welding. Metal machining (construction and operation only) - lathe, metal finishing- Surface grinding

Energy resources - Renewable, Non renewable energy. Prime movers- Types and applications. Internal Combustion Engine- working of petrol, diesel engines, Domestic refrigerator – Vapour compression Refrigeration.

Industrial Safety practice & Protective Devices-General requirements- Eye and face protection.- Respiratory Protection - Head protection - Foot protection- Hand Protection.

Note: All the topics are to be taught / illustrated with product / component examples from domestic appliances (mixer, grinder, refrigerator, table, chair, cook wares, fan, bath tub, soap box, water tap, pin, clip), transports (bicycle, car, train, ship, aeroplane), Industrial components (gas stove burner, bolt, nut, window frame, gate, motor, pump, compressor, exhaust fan, nail, keys, table weight), etc

Assignments with power point presentation in other related topics like (not included for terminal examinations)

Different modes of heat transfer, Boilers, Pumps, Thermal, Wind, tidal, geothermal nuclear, Gas turbine power plants, Energy conservation, Alternate fuels, cryogenics, drilling operations, milling operations and surface finishing operations, Additive manufacturing.

Text Book

1. Basic Mechanical Engineering – Lecture notes by Dept. of Mechanical Engg., TCE,.
2. Shanmugam G and Palanichamy M S, “Basic Civil and Mechanical Engineering”, Tata McGraw Hill Publishing Co., New Delhi, 1996.
3. Prabhu.T.J, Jai Ganesh. V and Jebaraj.S, “Basic Mechanical Engineering”, Scitech Publications, Chennai, 2000.

Reference Books

1. Bhandari V B, "Design of Machine Elements", Tata McGraw hill Publications, Second edition, 2009.
2. Hajra Choudhury. S.K, Hajra Choudhury. A.K, Nirjhar Roy, “Elements of Workshop Technology”, Vol. 1, Media Promoters, 2009.
3. Venugopal K. and Prahua Raja V., “Basic Mechanical Engineering”, Anuradha Publishers, Kumbakonam, 2000.
4. Shantha Kumar S R J., “Basic Mechanical Engineering”, Hi-tech Publications, Mayiladuthurai, 2000.

Course Contents and Lecture Schedule

Module No.	Topic	No. of Lectures
1.0	History and evolution of Mechanical Engineering	1
2.0	Steps of design procedure – Materials for engineering components, stress, strain, Factor of safety	2
2.1	Transmission systems- Belt and gear drives	1
3.0	Manufacturing processes	
3.1	Types of manufacturing industries and manufacturing systems, foundry - green sand mould casting	1
3.2	Metal forming - forging, rolling, extrusion, drawing,	2
3.3	Metal joining – Resistance Arc and Gas welding	1
3.4	Metal machining (construction and operation only) - lathe	2
3.5	Metal finishing- Surface grinding	1
4.0	Energy resources - renewable, non renewable	1
4.1	Prime movers- Types and applications.	1
4.2	Internal Combustion Engine- Working of petrol, diesel engines	2
4.3	Domestic refrigerator – Vapour compression Refrigeration	1
5.0	Industrial Safety Practice & Protective Devices	1
6	Assignments with power point presentation	5
	Total no. of periods	22

Course Designers:

- | | | |
|----|-----------------------|----------------------|
| 1. | Dr. M. Kathiresan | umkathir@tce.edu |
| 2. | Mr. M. S. Govardhanan | govardhanans@tce.edu |

14ES160	BASICS OF ELECTRICAL AND ELECTRONICS ENGINEERING	Category	L	T	P	Credits
		ES	2	0	0	2

A. BASICS OF ELECTRICAL ENGINEERING**Preamble**

It is an introductory course which emphasize the fundamental concepts and overview of Electrical Engineering. The concepts discussed herein are intended to provide clarification on basic electrical engineering for beginners of all engineering graduates.

Prerequisite

NIL

Course Outcomes

On the successful completion of the course, the students will be able to:

CO1	Explain the evolution of electricity and list the inventors.	Remember
CO2	Explain the basic electrical quantities and laws.	Understand
CO3	Explain the types of electrical equipment, machines and its applications.	Understand
CO4	Show the tariff for a given load and energy consumption.	Understand
CO5	Explain the electrical safety issues and protective devices.	Understand
CO6	Explain the roles of authorities governing Indian Electricity.	Understand
CO7	Explain the concept of renewable and non renewable resources of power generation systems.	Understand

Assessment Pattern

Bloom's Category	Continuous Assessment Tests			Terminal Examination
	1	2	3	
Remember	10	10	Through Assignment and Seminar	10
Understand	40	40		40
Apply	0	0		0
Analyse	0	0		0
Evaluate	0	0		0
Create	0	0		0

Course Level Assessment Questions**Course Outcome 1:**

1. Name the invention of Benjamin Franklin in 1747.
2. List the names of inventors of electrical quantities.
3. Write the year of installation of first hydro electric power plant.

Course Outcome 2:

1. State Ohm's Law.
2. Define Power & Energy.
3. Differentiate DC and AC supply.

Course Outcome 3 :

1. List the types of electric machines.
2. Name the types of analog meters for measuring current & voltage.
3. List the applications of induction motor.

Course Outcome 4 :

1. Show the energy consumed per year by a load of 60 W operated for 5 hours a day.
2. Write the expression relating power and energy.
3. State the need of star rating for equipment.

Course Outcome 5:

1. Distinguish between circuit breaker and lightning arrester.
2. List the various types of electrical hazards.
3. List the few electrical safety devices.

Course Outcome 6 :

1. List the various authorities governing Indian electricity.
2. List the activities of TEDA.
3. State the role of Central Electricity Regulatory Commission.

Course Outcome 7 :

1. State the significances of renewable power generation.
2. List the sources of renewable power.
3. State the limitation of non renewable power generation.

Concept Map

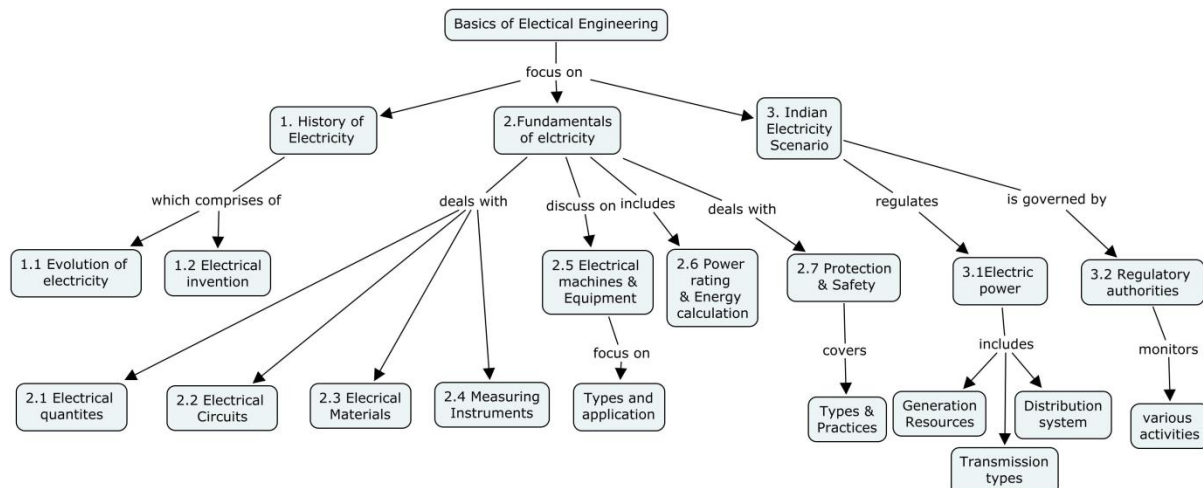

Syllabus

History of Electricity

Evolution of Electricity and Electrical inventions.

Fundamentals of Electricity

Electrical quantities- Charge, Electric potential, voltage, current, power, energy, DC, AC, time period, frequency, phase, flux, flux density, RMS, Average, Peak, phasor & vector diagram.

Electric Circuits - Passive components (RLC), Ohm's law, KCL, KVL, Faraday's law, Lenz's law.

Electrical materials – Conducting and insulating materials.

Measuring Instruments – Analog and Digital meters – Types and usage.

Electrical Machines & Equipment- Types, Specifications and applications.

Power rating and Energy calculation – for a sample load (domestic loads). Energy Efficient equipment – star ratings.

Protection & Safety - Hazards of electricity - shock, burns, arc-blast, Thermal Radiation, explosions, fires, effects of electricity on the human body. Electrical safety practices, Protection devices.

Indian Electricity Scenario

Electric Power- Generation resources, Transmission types & Distribution system (levels of voltage, power ratings and statistics)

Regulatory Authorities governing Indian Electricity - Roles of : MNRE,NTPC, NPCIL PGCIL, APTEL, [CERC](#), SERC, CTU, STU, NLDC, RLDC,SLDC, RFO,BEE,TNEB, IREDA,TEDA.

Text Book

1. Basics of Electrical Engineering – Lecture Notes, Dept. of EEE, TCE, Madurai.

Course Contents and Lecture Schedule

Module No.	Topic	No. of Lectures
1.	History of Electricity	
1.1	Evolution of Electricity and Electrical inventions.	2
2.	Fundamentals of electricity	
2.1	Electrical quantities- Charge, Electric potential, voltage, current, power, energy, DC,AC, time period, frequency, phase, flux, flux density, RMS, Average, Peak, phasor & vector diagram.	2
2.2	Electrical circuits - Passive components (RLC), Ohm's law, KCL, KVL, Faraday's law, Lenz's law.	1
2.3	Electrical materials – Conducting and insulating materials.	1
2.4	Measuring Instruments- Analog and Digital meters – Types and usage	1
2.5	Electrical Machines & Equipment - Types, Specifications and applications.	2
2.6	Power rating and Energy calculation – for a sample load (domestic loads). Energy Efficient equipment – star ratings.	1
2.7	Protection & Safety - Hazards of electricity - shock, burns, arc-blast, Thermal Radiation, explosions, fires, effects of electricity on the human body. Electrical safety practices, Protection devices.	2
3.	Indian Electricity Scenario	
3.1	Electric Power- Generation resources, Transmission types & Distribution system (levels of voltage, power ratings and statistics).	2
3.2	Regulatory Authorities governing Indian electricity - Roles of : MNRE,NTPC, NPCIL PGCIL, APTEL, CERC, SERC, CTU, STU, NLDC, RLDC,SLDC, RFO,BEE,TNEB, IREDA,TEDA.	2
4	Assignments/Seminars: Evolution of Electrical Engineering, Electrical Equipment, Machines and its applications, Energy tariff calculation, Power generation, Protection devices, Indian Electricity Governance.	6
Total		22

Course Designers:

- | | | |
|----|-------------------|--|
| 1. | Mr.B.Ashok Kumar | ashokudt@tce.edu |
| 2. | Dr.S.Charles Raja | charlesrajas@tce.edu |
| 3. | Mr.G.Sivasankar | qsiva@tce.edu |
| 4. | Mr.V.Seetharaman | yseetharaman@tce.edu |

B.BASICS OF ELECTRONICS ENGINEERING

Preamble

Basic Electronics is a primary course for all engineering students. The course work aims in imparting fundamental knowledge on electronic components and communication engineering concepts. The objective of this course is to help students acquire knowledge in real life applications.

Prerequisite

Basic course (No prerequisite)

Course Outcomes

On the successful completion of the course, students will be able to

CO1: Understand the basic electronic components	Understand
CO2: Identify Frequency Spectrum and Applications	Apply
CO3: Explain the operation of Communication blocks	Understand
CO4: Understand the applications of Electronics and Communication devices	Understand

Assessment Pattern

Bloom's Category	Continuous Assessment Tests			Terminal Examination
	1	2	3	
Remember	30	20	Assignment and Seminar	15
Understand	20	30		25
Apply	0	0		10
Analyse	0	0		0
Evaluate	0	0		0
Create	0	0		0

Course Level Assessment Questions

Course Outcome 1 (CO1):

1. Differentiate Electrical and Electronics.
2. Explain the operation of Diodes and Transistors.

Course Outcome 2 (CO2):

1. Explain different configurations of Transistors
2. Identify the frequency spectrum for mobile communications.

Course Outcome 3 (CO3):

1. Describe the operation of communication transceivers
2. Specify the types of communication systems.

Course Outcome 4 (CO4):

1. List different Real time Electronics Products.
2. Explain the concept behind satellite communication

Concept Map

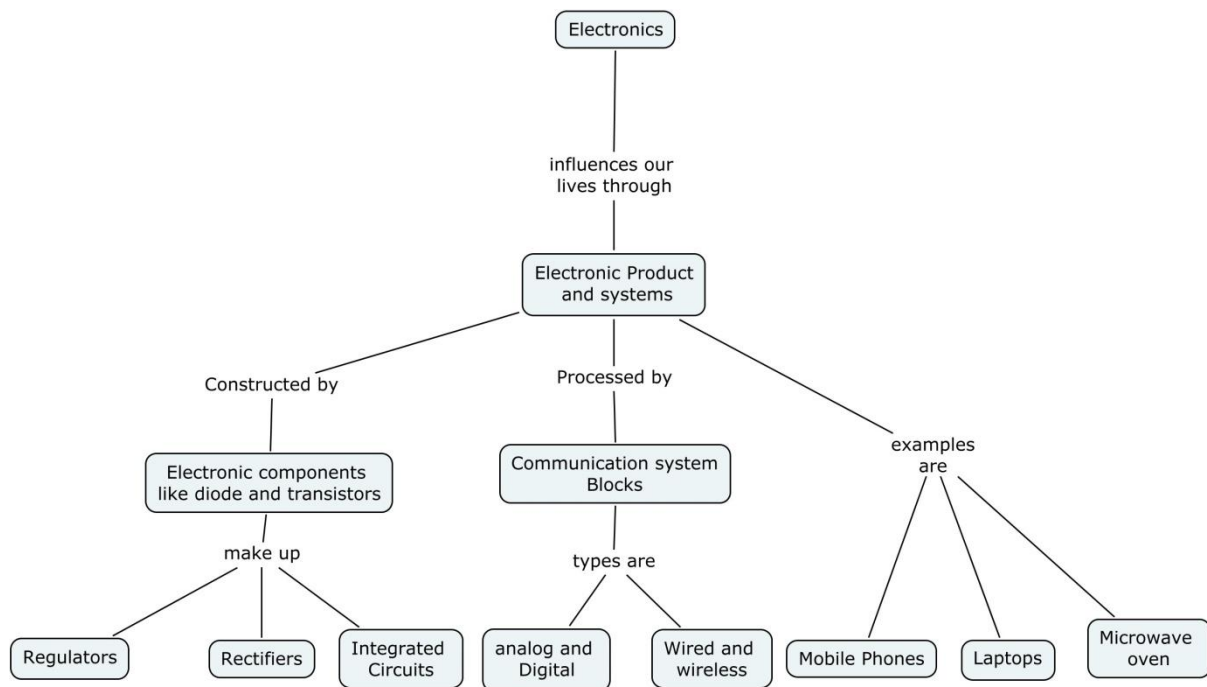

Syllabus

Electronics

Electrical Vs Electronics, Electronic products and systems, Electronic Devices (Diode – Forward bias, reverse bias, Transistor (CE, CB, CC)), Electronic components, Electronic Circuit (Rectifier, Regulator & IC), Amplifiers and Oscillators

Communication

Frequency spectrum and applications, Types of Communication systems (analog Vs digital, wire –optical, wireless, satellite), Communication system Block diagram (Transmitter and Receiver)

Applications

Mobile Phones, Laptop, Satellite, Microwave Oven – Qualitative Approach.

Text Book

1. Basic Electronics and Communication Engineering – Lecture Notes, Dept. of ECE, TCE, Madurai.

Reference Books

1. Albert Paul Malvino, "Electronic Principles", Tata Mcgraw Hill, 2002
2. Simon Haykin, "Communication Systems", Wiley Eastern, Third Edition, 1996
3. Faculty of Network Institutions, "Analog electronics", Project Network Engineering Series, 2004
4. Simon Haykin, Barry Van Veen, "Signals and Systems", Wiley, 2nd Edition, 2002

Course Contents and Lecture Schedule

Module No.	Topic	No. of Lectures
1.	Electronics	
1.1	Electrical and Electronics Principles	1
1.2	Electronic products and systems	1
1.3	Electronic Devices – Diodes and Transistors	1
1.4	Transistor Configuration CE, CB and CC	1
1.5	Electronic Circuits – Rectifier, Regulator & IC	1
1.6	Amplifiers and Oscillators	2
2.	Communication	
2.1	Frequency spectrum and applications	1
2.2	Types of Communication systems	1
2.3	Communication system Block diagram	1
2.4	Transmitter	1
2.5	Receiver	1
3.	Applications -Qualitative Approach.	
3.1	Mobile Phones	1
3.2	Laptops	1
3.3	Satellite	1
3.4	Microwave Oven	1
Total		16

Course Designers:

- | | |
|-----------------------------|--------------------|
| 1. Dr.S.Raju | hodece@tce.edu |
| 2. Dr.RSukanesh | drsukanesh@tce.edu |
| 3. Dr.M.Suganthi | msuganthi@tce.edu |
| 4. Dr.M.S.K.Manikandan | manimsk@tce.edu |
| 5. Dr.D.Gracia Nirmala Rani | gracia@tce.edu |

14ME170 ENGINEERING GRAPHICS

Category L T P Credit
ES 2 0 2 3

Preamble

Engineering Graphics is referred as language of engineers. An engineer needs to understand the physical geometry of any object through its orthographic or pictorial projections. The knowledge on engineering graphics is essential in proposing new product through drawings and interpreting data from existing drawings. This course deals with orthographic and pictorial projections, sectional views and development of surfaces.

Prerequisite

NIL

Course Outcomes

On successful completion of the course, students will be able to

- CO1: Draw the orthographic projections of points, straight lines, plane surfaces and solids. Apply
- CO2: Draw the orthographic projections of sectioned solids and true shape of the sections. Apply
- CO3: Develop lateral surfaces of the uncut and cut solids. Apply
- CO4: Draw the pictorial projections (isometric and perspective) of simple solids. Apply
- CO5: Sketch by free hand the orthographic views from the given pictorial view. Apply

Assessment Pattern

Bloom's Category	Continuous Assessment Tests			Terminal Examination
	1	2	3	
Remember				
Understand				
Apply	100	100	100	100
Analyse				
Evaluate				
Create				

Course Level Assessment Questions

Course Outcome 1: Students will be able to draw the orthographic projections of points, straight lines, plane surfaces and solids.

1. Draw the projection of points on a common reference line. Take 20 mm distance between the projectors.
 1. Point K is 10 mm above H.P. and 25 mm in front of V.P
 2. Point L is 10 mm above H.P. and on the V.P
 3. Point M is 25 mm below H.P. and 20 mm behind V.P
 4. Point N is 20 mm below H.P. and 20 mm in front of V.P
 5. Point O is on the reference line.
 6. Point P is on both H.P. and V.P

2. A line RS, 80 mm long has its end R, 20 mm above HP and 30 mm in front of VP. The top and front views of the line have the lengths of 50 mm and 65 mm respectively. Draw the projections of the line and find its true inclinations with HP and VP.
3. A thin rectangular plate of sides 60 mm x 30 mm has its shorter side in the V.P and inclined at 30° to the H.P. Project the top view of plate, if its front view is a square of 30 mm side.
4. Draw the projections of a pentagonal prism of base side 30 mm and axis length 60 mm when it lies on the ground on one of its rectangular faces with its axis inclined at 35° to V.P and parallel to H.P.

Course Outcome 2: Students will be able to draw the orthographic projections of sectioned solids and true shape of the sections.

1. A square pyramid of base 40 mm side and axis 65 mm long has its base on the ground and all the base edges equally inclined to V.P. It is cut by a section plane, perpendicular to V.P, inclined at 45° to H.P and bisecting the axis. Draw the elevation, sectional plan and true shape of the section.
2. A cube of 35 mm side is resting on ground on one of its faces with a vertical face inclined at 30° to VP. It is cut by a cutting plane perpendicular to HP and inclined at 60° to VP so that a face which makes 60° angle with VP is cut into two equal halves. Draw the sectional elevation, plan and true shape of the section.
3. A cone of 60 mm base circle diameter and axis height 70 mm is resting on HP with a point on its circumference such that the generator containing that point is perpendicular to HP. The cone is cut by a plane parallel to HP and perpendicular to VP bisecting the axis. Draw the elevation and sectional plan.

Course Outcome 3: Students will be able to develop lateral surfaces of the uncut and cut solids.

1. A pentagonal pyramid of base 50 mm side and axis 75 mm long has its base on the ground. It is cut by a section plane, perpendicular to V.P, inclined at 30° to H.P intersecting the axis at 40 mm from apex. Draw the development of the lateral surface of its lower portion.
2. A hexagonal prism of 45 mm side and axis height 70 mm is resting on ground with its base. It is cut by i) a horizontal cutting plane at 25 mm from base and ii) a cutting plane inclined to HP at 35° passing through a point on the axis at 20 mm from its top. Draw the development of the lateral surface of its middle portion.
3. A cylinder of 70 mm base diameter and axis height 90 mm is resting on HP with its base. It contains a circular through hole of 30 mm diameter on its periphery, with the axis of hole parallel to HP and perpendicular to VP, bisecting the cylinder axis. Draw the development of the cylindrical surface.

Course Outcome 4: Students will be able to draw the pictorial projections (isometric and perspective) of simple solids.

1. Draw the isometric view of a pentagonal pyramid of base side 32 mm and height 75 mm when its base is parallel to HP with one of its base edges parallel to VP. The vertex is below the base.
2. Draw the isometric projection of a hexagonal prism of base side 30 mm and height 70 mm when it lies on the ground with one of its face edges and axis parallel to HP and VP.
3. A regular hexagonal pyramid of base edge 30 mm and height 50 mm rests on its base on the ground plane with one of its base edges touching the picture plane. The station point is 40 mm above the ground plane and 50 mm in front of PP. The central plane is

4. 35 mm to the right of the axis. Draw the perspective projection of the pyramid. A cylinder of diameter 40 mm and height 50 mm rests on GP on one of its ends with its axis 40 mm behind the picture plane. The station point is 50 mm to the right of the axis. The station point is 70 mm above the GP and 45 mm in front of PP. Draw the perspective view of the cylinder.

Course Outcome 5: Students will be able to sketch by free hand the orthographic views from the given pictorial view.

1. Draw the front view, top view and left side views of the given block from its pictorial view.

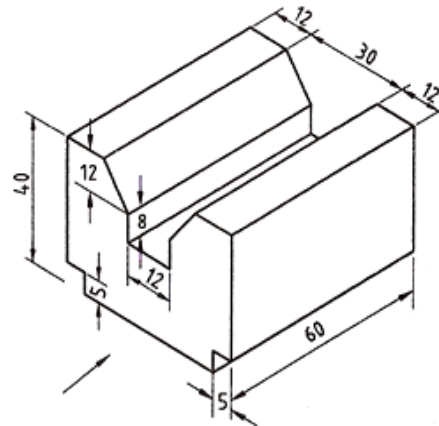

2. Draw the orthographic projections for the given object.

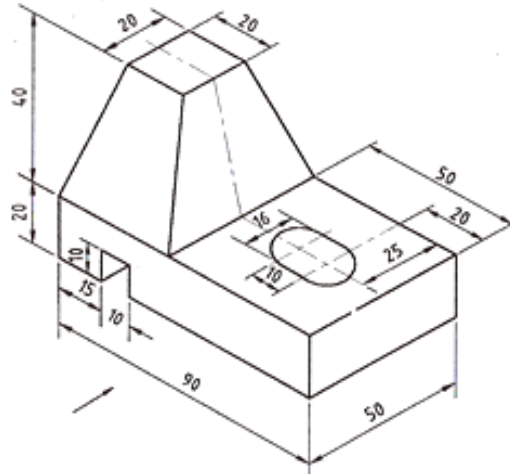

3. Draw the Elevation, Plan and Right side view for the given shaft bracket.

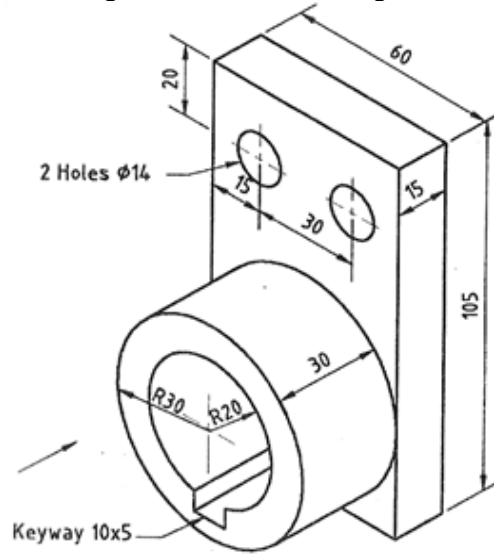

Concept Map

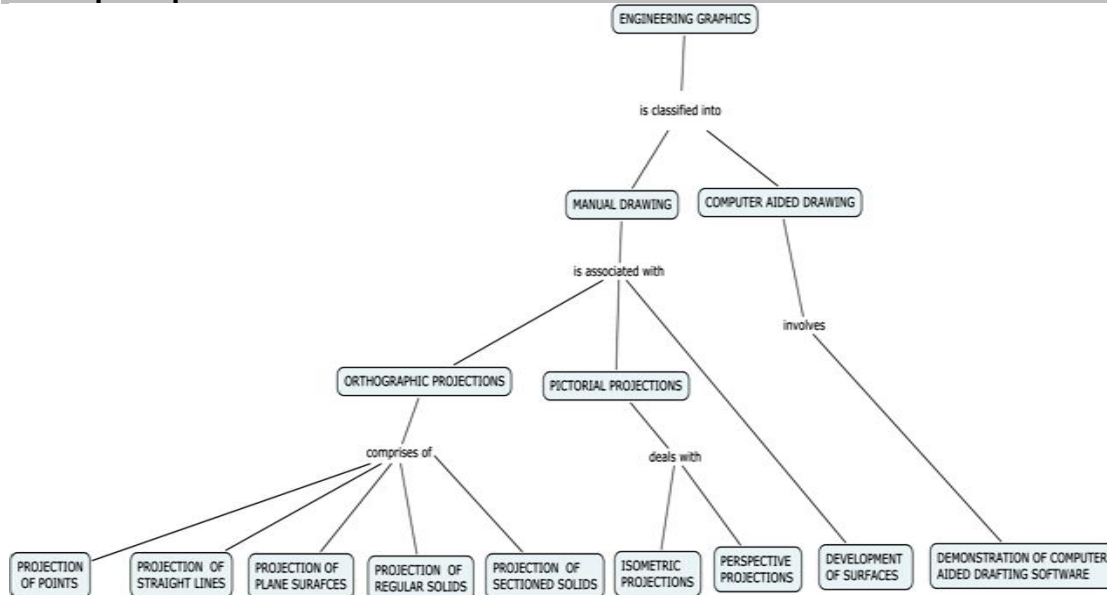

Syllabus

Introduction- Importance of graphics in engineering applications – Use of drafting instruments -Size, layout and folding of drawing sheets - BIS Standards – Lettering and dimensioning, construction of polygons.

Orthographic projections - Introduction - Principles -Principal planes-First angle projection.

Projection of points located in all quadrants. **Projection of straight lines** inclined to both the principal planes - Determination of true lengths and true inclinations by rotating line method, traces. **Projection of planes** (regular polygonal and circular surfaces) inclined to both the principal planes by rotating object method. **Projection of regular solids*** by rotating object method when the axis is inclined to one of the principal planes. **Projection of sectioned solids** and true shape of the sections (Axis of the solid perpendicular to HP).

Development of lateral surfaces of regular* and sectioned solids.

Pictorial Projections – Introduction - **Isometric projection** – Principle, isometric scale, Isometric projections of regular solids* when the axis is i) perpendicular to HP ii) perpendicular to VP (iii) parallel to both HP and VP. **Perspective projection** - Principle, perspective projection of regular solids* when the axis is perpendicular to i) Ground Plane ii) Picture plane by visual ray method.

Free hand sketching of multiple orthographic views from single pictorial view of objects.
Introduction to drafting packages and demonstration. (Not for examination).
 (*prisms, pyramids, cylinder and cone).

Text Book

1. Bhatt N.D. and Panchal V.M., "Engineering Drawing", Charotar Publishing House, 50th Edition, 2010.

Reference Books

1. Natarajan K.V., "A text book of Engineering Graphics", Dhanalakshmi Publishers, Chennai, 2009.
2. Basant Agarwal and Agarwal C.M., "Engineering Drawing", Tata McGraw Hill Publishing Company Limited, New Delhi, 2008
3. Venugopal K. and Prabhu Raja V., "Engineering Graphics", New Age International (P) Limited, 2008.
4. Gopalakrishna K.R., "Engineering Drawing" (Vol. I&II combined), Subhas Stores, Bangalore, 2007.

Course Contents and Lecture Schedule

Sl.No	Topic	Lecture Hrs (Periods)	Practical Hrs (Periods)
1	Introduction- Importance of graphics in engineering applications – Use of drafting instruments -Size, layout and folding of drawing sheets – BIS Standards - Lettering and dimensioning, construction of polygons.	2	3
2	Orthographic projection - Introduction - Principles -Principal planes-First angle projection, Projection of points located in all quadrants.	2	3
3	Projection of straight lines inclined to both the principal planes - Determination of true lengths and true inclinations by rotating line method, traces.	4	6
4	Projection of planes (regular polygonal and circular surfaces) inclined to both the principal planes by rotating object method.	4	6
5	Projection of regular solids (prisms, pyramids, cylinder and cone) when the axis is inclined to one of the principal planes by rotating object method.	4	6
6	Projection of sectioned solids and true shape of the sections (Axis of the solid perpendicular to HP)	2	3
7	Development of lateral surface of regular and truncated solids.	2	3
8	Isometric projection – Principle, isometric scale, Isometric projections of regular solids when the axis is i) perpendicular to HP ii) perpendicular to VP (iii) parallel to both HP and VP.	2	3
9	Perspective projection - Principle, perspective projection of regular solids when the axis is perpendicular to i)Ground Plane ii) Picture plane by visual ray method.	2	3
10	Free hand sketching of multiple orthographic views from pictorial view of objects.	2	3
11	Introduction to drafting packages and demonstration.	2	-
	Test		3
	TOTAL	28	42

Question Pattern for Terminal Examination			
Question Number	Description	Type	Marks
1	Projection of Points (OR) Free hand sketching of orthographic views from pictorial views	Either or	10
2	Projection of lines	Either or	15
3	Projection of planes	Either or	15
4	Projection of solids	Either or	15
5	Section of solids	Either or	15
6	Development of surfaces	Either or	15
7	Isometric Projection (OR) Perspective projection	Either or	15
Total			100

- Note:**
- Plates (Drawing sheets) submitted by students will be considered for internal assignment marks (30).
 - One test will be conducted locally by respective faculty-in-charge during regular class hours for internal test marks (20).
 - Terminal examination will be conducted centrally by the office of controller of examinations.

Course Designers:

- | | | |
|----|------------------|--------------------|
| 1. | Mr.A.Samuel Raja | samuel1973@tce.edu |
| 2. | Mr.M.Kannan | mknmech@tce.edu |

14PH180	PHYSICS LABAROTARY	Category	L	T	P	Credit
		BS	0	0	2	1

Preamble

The course aims in imparting fundamental knowledge of experimental Physics. The error analysis is essential for understanding and analyzing the results of any experiment. Basic experiments in thermal applications and optics are introduced. Characteristics and uses of Laser & fiber optics have been included. The outcome of the course is to help students determine physical constants, Viscosity, Band gap, wavelength of a Laser and Acceptance angle of a fiber.

LIST OF EXPERIMENTS

1. Error analysis
2. Compound pendulum- acceleration due to gravity
3. Poiseulle's flow method-viscosity determination
4. Solar cell characteristics
5. Plank's constant determination
6. Energy band gap of junction diode
7. Spectrometer – dispersive power of the prism
8. Microscope- thickness of wire by air wedge
9. Laser- particle size and wavelength determination
10. Fiber optics –numerial aperture & acceptance angle determination

Course Designers:

- | | |
|---------------------|----------------|
| 1. Dr.R.Vasuki | rvphy@tce.edu |
| 2. A.L.Subramaniyan | alsphy@tce.edu |
| 3. D.Ravindran | drphy@tce.edu |

		Category	L	T	P	Credit
14CH190	CHEMISTRY LABORATORY	BS	0	0	2	1

Preamble

The objective of this course is to develop the intellectual and psychomotor skills of the students by imparting knowledge in material, quantitative and electrochemical analysis.

Course Outcomes

On the successful completion of the course, students will be able to

- | | |
|--|---------|
| • Analyse the material qualitatively | Analyse |
| • Estimate the chemical parameters of water | Apply |
| • Calculate the strength of acids, oxidizing and reducing agents | Analyse |

List of Experiments

1. Material analysis

- i) Analysis of Boiler scale
- ii) Analysis of Cement
- iii) Analysis of alloy sample

2. Quantitative analysis

- i) Estimation of Total Hardness of water sample
- ii) Estimation of Ca^{2+} and Mg^{2+} individual hardness of water sample
- iii) Estimation of Alkalinity of water sample
- iv) Estimation of Chloride in a water sample
- v) Estimation of COD

3. Electrochemical analysis

- i) Conductometry Titration (Strong acid Vs Strong base, Mixture of acids Vs Strong base)
- ii) Potentiometric redox Titration ($\text{K}_2\text{Cr}_2\text{O}_7$ Vs FAS, KMnO_4 Vs FAS)

Course Designers:

- | | | |
|----|-----------------|--------------------|
| 1. | Dr.Mrs.k.Radha | hodchem@tce.edu |
| 2. | Dr.S.Balaji | sbalaji@tce.edu |
| 3. | Dr.V.Velkannan | velkannan@tce.edu |
| 4. | Dr.S.Sivailango | drssilango@tce.edu |

CURRICULUM AND DETAILED SYLLABI
FOR
SECOND SEMESTER
B.E. DEGREE PROGRAMME
IN
ELECTRONICS AND COMMUNICATION ENGINEERING

FOR THE STUDENTS ADMITTED IN THE
ACADEMIC YEAR 2014-15 ONWARDS

DEPARTMENT OF ELECTRONICS AND COMMUNICATION ENGINEERING
THIAGARAJAR COLLEGE OF ENGINEERING
(A Government Aided ISO 9001:2008 certified Autonomous Institution affiliated to Anna
University)
MADURAI – 625 015, TAMILNADU

Phone: 0452 – 2482240, 41

Fax: 0452 2483427

Web: www.tce.edu

14EC210	ENGINEERING MATHEMATICS II	Category	L	T	P	Credit
		BS	2	1	0	3

Preamble

Vector calculus is a form of mathematics that is focused on the integration of vector fields. An Engineer should know the Transformations of the Integrals, as Transformation of Line Integral to surface and then to volume integrals. The Laplace transform method is a powerful method for solving linear ODEs and corresponding initial value problems as well as systems of ODEs arising in Engineering. The knowledge of transformations is to create a new domain in which it is easier to handle the problem that is being investigated. Complex Integration approach is very useful to evaluate many improper integrals of a real variable.

Prerequisite

Nil

Course Outcomes

On the successful completion of the course, students will be able to

CO1	Formulate and solve problems of engineering dynamics using different differential operators.	Apply
CO2	Formulate the problem of computing areas and volumes through vector integration, and determine them by applying Green, Stokes and Divergence theorems	Apply
CO3	Determine maxima and minima of functions of several variables using analytical and Lagrangian multipliers methods	Apply
CO4	Determine the values of multiple integrals directly or by changing the order of integration or by making transformation with Jacobians.	Apply
CO5	Determine areas and volumes of geometrical figures using multiple integrals, beta and gamma functions.	Apply
CO6	Analyze functions of complex variable in terms of continuity, differentiability and analyticity.	Apply
CO7	Apply Cauchy-Riemann equations and harmonic functions to problems of fluid mechanics, thermodynamics and electro-magnetic fields.	Apply
CO8	Find singularities of complex functions and determine the values of integrals using residues.	Apply
CO9	Geometrically interpret conformal and bilinear transformations	Apply

Mapping with Programme Outcomes

COs	PO 1	PO 2	PO 3	PO 4	PO 5	PO 6	PO 7	PO 8	PO 9	PO 10	PO 11	PO 12	PSO 1	PSO 2	PSO 3
CO1	S	S	M	L	-	-	-	L	L	-	-	M	S	L	L
CO2	S	S	M	L	-	-	-	L	L	-	-	M	S	L	L
CO3	S	S	M	L	-	-	-	L	L	-	-	M	L	L	L
CO4	S	S	M	L	-	-	-	L	L	-	-	M	S	L	L
CO5	S	S	M	L	-	-	-	L	L	-	-	M	S	L	L
CO6	S	S	M	M	-	-	-	L	L	-	-	M	S	L	L
CO7	S	S	M	M	-	-	-	L	L	-	-	M	S	L	L
CO8	S	S	M	L	-	-	-	L	L	-	-	M	S	L	L
CO9	S	S	M	L	-	-	-	L	L	-	-	M	S	L	L

Assessment Pattern

Bloom's Category	Continuous Assessment Tests			Terminal Examination
	1	2	3	
Remember	10	10	10	10
Understand	30	30	30	20
Apply	60	60	60	70
Analyse	0	0	0	0
Evaluate	0	0	0	0
Create	0	0	0	0

Course Level Assessment Questions**Course Outcome 1 (CO1):**

1. Compute $L^{-1}\left(\frac{p+8}{p^2+4p+5}\right)$
2. Show that $\int_0^t e^{-4t} t \sin 3t dt = \frac{6}{(s^2+8s+25)^2}$
3. Using convolution theorem in Laplace Transform, evaluate $\int_0^t \sin u \cos(t-u) du$
4. Solve the Equation $y''+9y = \cos 2t$, $y(0)=1$ & $y\left(\frac{\pi}{2}\right) = -1$ using Laplace Transform.

Course Outcome 2 (CO2)

1. Compute an analytic function $f(z)=u+iv$, where $u = e^x(x \cos y - y \sin y)$.
2. Using convolution theorem, compute $L^{-1}\left(\frac{s^2}{(s^2+a^2)(s^2+b^2)}\right)$
3. Show that the map $w = 1/z$ maps the circles and straight lines as circles or straight lines.
4. Demonstrate the Milne Thompson method to construct an analytic function $f(z)=u+iv$, given either $u(x,y)$ or $v(x,y)$.

Course Outcome 3(CO3):

1. Distinguish between the statement of Cauchy's Fundamental theorem & Cauchy's Fundamental formula.
2. Identify the residue of $\frac{z+1}{z^2-2z}$ at its poles.
3. Examine the Laurent's series expansion of $f(z) = \frac{z+4}{(z+3)(z-1)^2}$,
in (i) $0 < |z-1| < 4$ (ii) $|z-1| > 4$
4. Distinguish between isolated singularity and removable singularity.

Course Outcome 4 (CO4):

1. Define the term residue of $f(z)$ at $z = a$.
2. Give an example of meromorphic function.
3. Identify the singular points of $\frac{1}{(2 \sin z - 1)^2}$

Course Outcome 5 (CO5):

$$\int_0^1 \int_0^2 \int_0^1 dx dy dz$$

1. Evaluate $\int_0^1 \int_0^2 \int_0^1 dx dy dz$
2. Distinguish between triple integral and volume integral.
3. Estimate the area enclosed by the curves $y = x^2$ and $x + y = 2$
4. Predict the limits of $\int_0^a \int_0^x f(x, y) dy dx$ by changing the order of integration.

Course Outcome 6 (CO6):

1. Using Taylor's theorem, show that

$$\log z = (z-1) - \frac{(z-1)^2}{2} + \frac{(z-1)^3}{3} - \dots, \text{ where } |z-1| < 1$$

2. Using Green's theorem for $\vec{f} = (x^2 + y^2)\vec{i} - 2xy\vec{j}$ taken around the rectangle bounded by the lines $x=0, x=a, y=0$ and $y=b$.
3. If $f(z) = u(r, \theta) + iv(r, \theta)$ is differentiable at $z = re^{i\theta}$, then show that

$$u_r = \frac{v_\theta}{r}, u_\theta = -r v_r$$

Concept Map

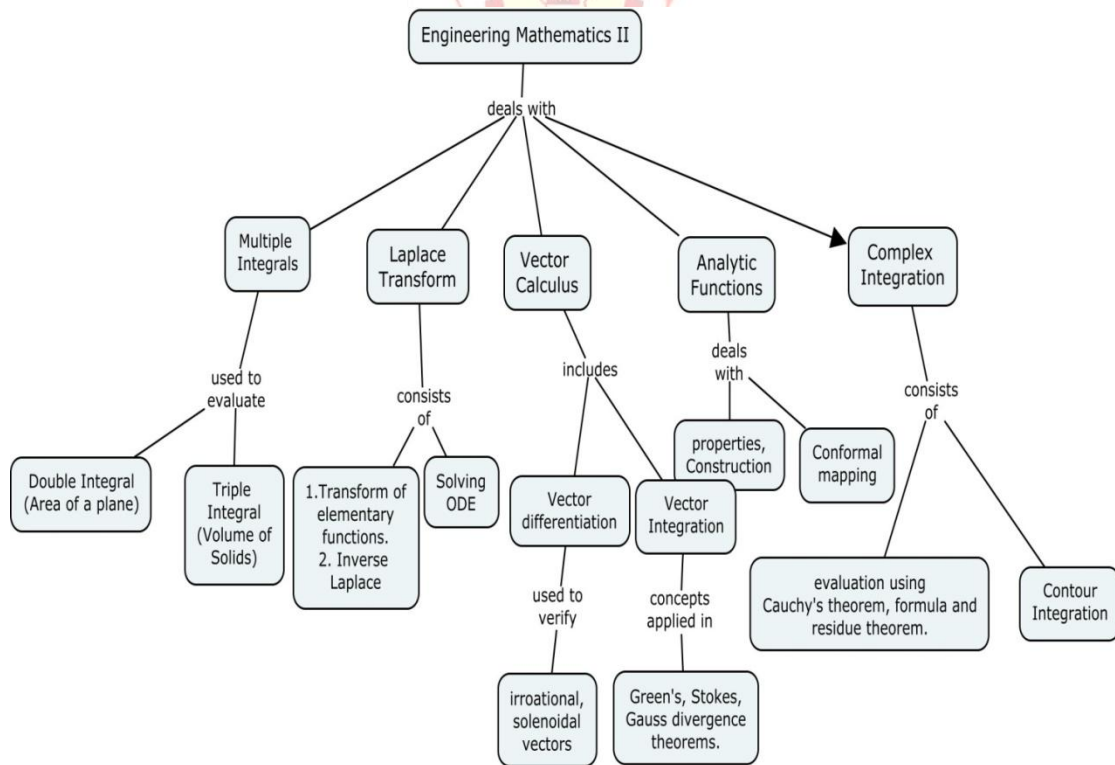

Syllabus

LAPLACE TRANSFORM : Laplace transform –Sufficient condition for existence –Transform of elementary functions –Basic properties –Transforms of derivatives and integrals of functions -Derivatives and integrals of transforms -Transforms of unit step function and impulse functions –Transform of periodic functions. Inverse Laplace transform -Statement of Convolution theorem –Initial and final value theorems–Solution of linear ODE of second order with constant coefficients using Laplace transformation techniques.

ANALYTIC FUNCTIONS : Functions of a complex variable –Analytic functions: Necessary conditions –Cauchy -Riemann equations and sufficient conditions (excluding proofs) – Harmonic and orthogonal properties of analytic function –Harmonic conjugate –Construction of analytic functions –Conformal mapping: $w = z^2$, $\sin z$, e^z and bilinear transformation.

COMPLEX INTEGRATION :Complex integration –Statement and applications of Cauchy's integral theorem and Cauchy's integral formula –Taylor's and Laurent's series expansions – Singular points –Residues –Cauchy's residue theorem –Evaluation of real definite integrals as contour integrals around unit circle and semi-circle (excluding poles on the real axis).

MULTIPLE INTEGRALS: Double integrals –Change of order of integration –Double integrals in polar coordinates –Area enclosed by plane curves –Triple integrals –Volume of Solids –Change of variables in double and triple integrals.

VECTOR CALCULUS: Gradient, divergence and curl –Directional derivative –Irrotational and solenoidal vector fields –Simple problems on Vector differentiation–Vector integration –Green's theorem in a plane, Gauss divergence theorem and Stokes' theorem(excluding proofs)–Simple applications.

Text Book

1. Grewal. B.S, "Higher Engineering Mathematics", 41stEdition, Khanna Publications, Delhi, 2011.
2. Erwin Kreyszig, 'Advanced Engineering Mathematics, 8th Edition, John Wiley & Sons, 2009.

Reference Books

1. T.Veerarajan, Engineering Mathematics, 3rd Edition, Tata McGraw Hill, New Delhi, 2004.
2. Thomas Phinny, Calculus, 13th Edition, Pearson Education, New Delhi, 2005.
3. B.V.Ramana, Higher Engineering Mathematics, Tata McGraw Hill, New Delhi,2011

Course Contents and Lecture Schedule

Module No.	Topic	No.of Lectures
1	Laplace Transformation	
1.1	Laplace transformation-properties, inverse Laplace transforms	3
	Tutorial	1
1.2	Periodic functions, convolution theorem, initial value theorem and final value theorem	3
1.3	Solution of differential equations and integral equations	2
	Tutorial	1
2	Analytic Functions	
2.1	Analytic functions, C-R equations and properties	2
2.2	Harmonic functions and Milne Thomson's method	2
	Tutorial	1
2.3	Conformal maps and bilinear transformations	3
	Tutorial	1
3	Complex Integration	
3.1	Cauchy's theorem and consequences	1

3.2	Evaluating integrals using Cauchy's integral formula	2
3.3	Taylor's and Laurent's expansions	2
	Tutorial	1
3.4	Singularities and Cauchy's residue theorem	1
3.5	Contour integration using unit circle and semicircular contours	3
	Tutorial	1
4	Multiple Integrals	
4.1	Double integrals and areas	2
4.2	Triple integrals and volumes	2
	Tutorial	1
4.3	Change of order of integration	1
4.4	Change of variables between Cartesian and polar with applications	2
	Tutorial	1
5	Vector Calculus	
5.1	Operators Grad, div and curl with properties	2
5.2	Solenoidal and irrotational vectors	2
	Tutorial	1
5.3	Vector integration(three famous theorems)	3
	Tutorial	1
	Total	48

Course Designers:

1. Dr.S.Jeyabharathi
2. Dr.G. Jothilakshmi
3. Dr.A.P.Pushpalatha

sjmat@tce.edu
gjmat@tce.edu
appmat@tce.edu

14EC220	PASSIVE NETWORK ANALYSIS AND SYNTHESIS	Category	L	T	P	Credit
		PC	2	1	0	3

Preamble

A network refers to any interconnected set of objects. An 'electrical network' is an interconnection of electrical elements (Active and Passive) such as resistors, inductors, capacitors, transformers, diodes, sources, controlled sources and switches. Passive networks have interconnection of elements which cannot generate energy but can dissipate or stored energy. All electrical and electronic devices can be represented by electric circuits. So formulation of equivalent circuit and the study of behavior of the devices such as filters and attenuators or networks is formulated by analyzing the equivalent circuit with network laws, theorem and graph theory. The behavior of electrical and mechanical devices can also be predicted by analyzing with equivalent circuits. Similarly the realization of network or device is also possible with synthesis techniques. One of the main competencies that an electronic engineer has to acquire is to analyse and synthesize passive networks that improve the final realization of passive networks and devices for a given applications.

Prerequisite

Nil

Course Outcomes

On the successful completion of the course, students will be able to

CO1 . Explain the nature of time domain and frequency domain behaviour of ideal one-port and two-port networks	Understand
CO2 .Apply and determine the time-domain behaviour of one port and two port networks	Apply
CO3 .Apply and determine frequency-domain behaviour of one port and two port networks	Analyze
CO4 .Analyze circuits using ideal passive elements and controlled sources	Create
CO5 .Synthesize one port and two port networks and devices	Analyze

Mapping with Programme Outcomes

COs	PO 1	PO 2	PO 3	PO 4	PO 5	PO 6	PO 7	PO 8	PO 9	PO 10	PO 11	PO 12	PSO 1	PSO 2	PSO 3
CO1	M	L	-	-	-	-	-	-	L	-	-	L	L	-	L
CO2	S	M	L	-	M	L	-	L	M	-	-	-	S	L	L
CO3	S	M	L	-	M	L	-	L	M	-	-	-	S	L	L
CO4	S	S	M	L	L	L	-	L	M	L	-	L	S	M	L
CO5	S	S	M	L	L	L	-	L	M	L	-	L	S	L	L

S- Strong; M-Medium; L-Low

Assessment Pattern

Bloom's Category	Continuous Assessment Tests			Terminal Examination
	1	2	3	
Remember	20	10	10	10
Understand	20	10	10	10
Apply	40	40	40	40
Analyse	20	20	20	20
Evaluate	0	10	10	10
Create	0	10	10	10

Course Level Assessment Questions

Course Outcome 1 (CO1):

1. What do we mean by Network synthesis? How is it different from network analysis?
2. Are network theorems applicable to a.c. networks also or their applications restricted to d.c. networks only.
3. Distinguish between steady state and transient response.
4. List the short comings of constant K filter section.
An R-L series circuit of $R = 10\Omega$ and $L = 1H$ is connected across a d.c voltage of 100V. What is amplitude of current flowing in the circuit?
5. How will you identify a LC network from its pole-zero diagram?
6. What is the need of positive real functions?

Course Outcome 2 (CO2):

CO1. By the superposition theorem, calculate the current through the $(2+j3)\Omega$ impedance branch of the circuit in the following Fig.

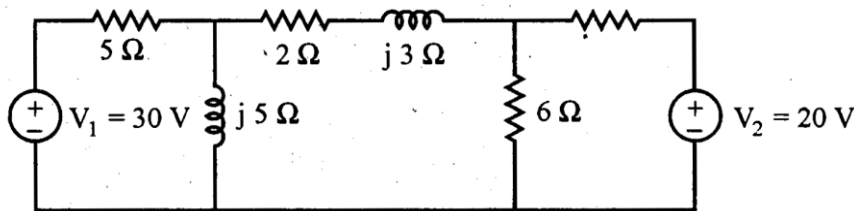

CO2. Find the current in R_L using Norton's Theorem.

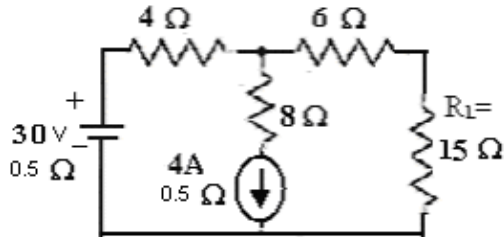

CO3. Find the resistance across A B for maximum power.

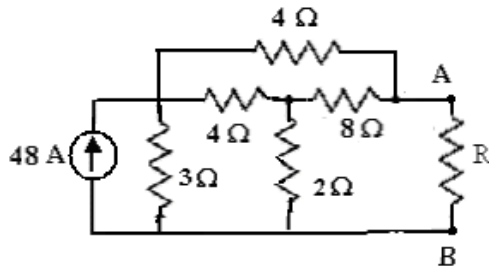

CO4. Find the driving point admittance $Y(s)$ for the following network.

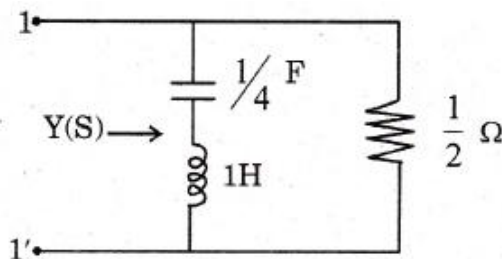

CO5. Obtain the Y- parameters of the following network.

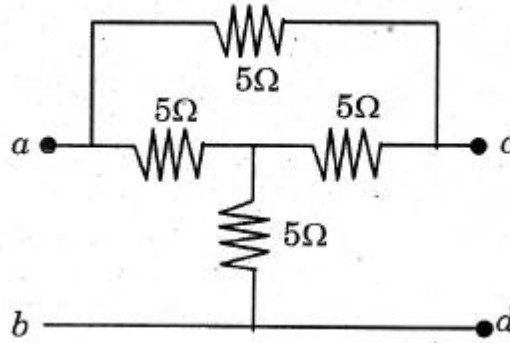

Course Outcome 3 (CO3):

1. Check whether the following two terminal network is symmetrical or reciprocal.

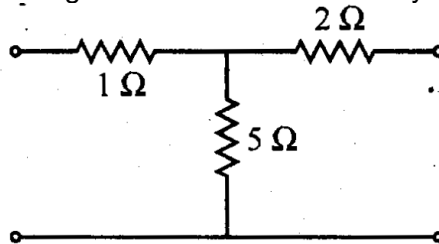

2. In the circuit of the figure shown below, find the expression for the transient current and the initial rate of growth of the transient current.

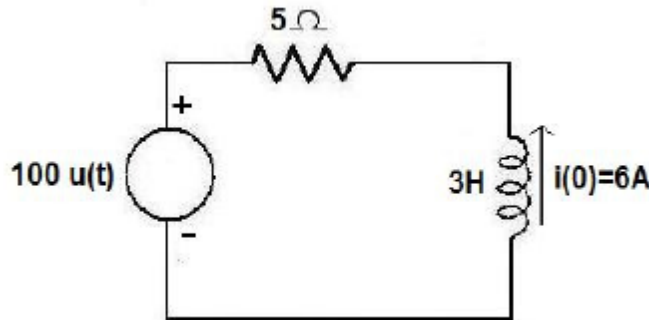

3. The voltage applied to the series RLC circuit is 5 V. The q factor of the coil is 25 and the value of the capacitor is 200PF. The resonant frequency of the circuit is 200KHz. Find the value of inductance, the circuit current and the voltage across the capacitor.
4. For the given denominator polynomial of a network function, verify the stability of the network using Routh criteria.

$$Q(s) = s^5 + 3s^4 + 4s^3 + 5s^2 + 6s + 1$$
5. For the given network function, draw the pole zero diagram and hence obtain the time domain response. Verify the result analytically.

$$V(s) = \frac{5(s+5)}{(s+2)(s+7)}$$

Course Outcome 4 (CO4):

1. Realize the network in Foster and Cauer form whose driving point impedance function $Z(s)$ is given by,

$$Z(s) = \frac{4(s^2 + 1)(s^2 + 9)}{s(s^2 + 4)}$$

2. Realize the driving point impedance as Foster's first and second forms from

$$Z(s) = \frac{(S^2 + 1)(S^2 + 4)}{S(S^2 + 2)}$$

- Design a constant k - type band pass filter section to be terminated in 600 Ω resistances having cut off frequencies of 2kHz and 5kHz.
- Synthesize the LC driving point impedance function to get Cauer first and second forms and draw the network.

$$Z(s) = \frac{(10S + 1)}{4S^2 + S + 4}$$

Concept Map

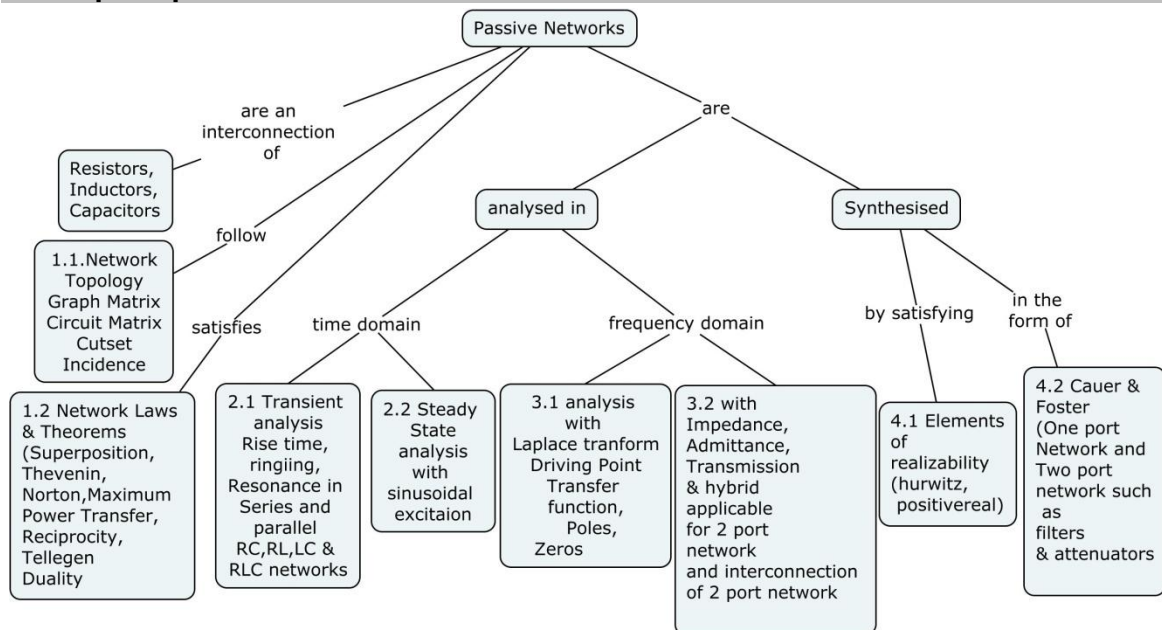

Syllabus

Introduction: Networks, passive networks, Importance of Network Analysis and Synthesis

Network Topology: Network topology, matrices associated with graphs; incidence, fundamental cut set and fundamental circuit matrices. **Networks Laws and Theorems:** Kirchoff's Laws- Loop and Nodal analysis, Superposition, Thevenin's and Norton's, Maximum power transfer, Reciprocity theorems, Tellegen's theorem, Source and Wye-Delta transformation, Duality.

Time domain analysis: Transient analysis: Series RL, RC, LC networks, significance of time constant, natural frequency, Resonance, Q factor. Steady state sinusoidal analysis of reactive networks.

Frequency domain analysis: The concept of complex frequency, Solution of network equations using Laplace transforms. Network functions: driving point and transfer functions, Poles and Zeros, their locations and effects on the time and frequency domain responses, Restriction of poles and zeros in the driving point and transfer function, Time domain behaviour from the pole-zero plot. Analysis of two port network: Network parameters- Impedance, admittance, transmission and hybrid, Conversion formulae. Equivalent circuits of T, Π ,

Ladder, bridged T and Lattice networks, Analysis of interconnected two port networks - parallel, series, and cascade connections, zeros of transmission.

Synthesis of Networks: Elements of Realizability Theory: Stability-Hurwitz Polynomials-Positive Real Functions- Elementary Synthesis Procedures – Cauer and Foster forms. Synthesis of One Port and two port Networks: Properties and synthesis of R-L, R-C , L-C Impedance and Admittance Functions. Filters and attenuators.

Text Book

1. Van Valkenberg, *Network Analysis*, Prentice-Hall of India, Third Edition, 2007.
2. Franklin F. Kuo, *Network Analysis and Synthesis*, Wiley India, Second Edition, 2006
3. Sudhakar .A and Shyammoan S Pall, “Circuits and Networks” Tata McGraw Hill, 4th edition, 2010

Reference Books

1. Umesh Sinha, “Network Analysis and Synthesis” Satyaprakashan Publishers, 2013.
2. Mahmood Nahvi and Joseph Edminister: *Electric Circuits* 4th Ed, Schaum’s Outlines, Tata McGraw-Hill, 2003
3. William H Hayt & Jack E Kemmerly, *Engineering Circuit Analysis*, Tata McGraw Hill, 7th edition, 2010
4. John D Ryder, “Networks, Lines and Fields”, Second Edition, PHI, 2007

Course Contents and Lecture Schedule

No.	Topic	No. of Lectures
	Introduction:	
1	Networks, Passive networks, Importance of Network Analysis and Synthesis	1
1.1	Network Topology: matrices associated with graphs, Incidence, fundamental cut set and fundamental circuit matrices	1
	Problem solving	1
1.2	Networks Laws and Theorems: Kirchoff’s Laws- Loop and Nodal analysis,.	2
	Problem solving	2
1.3	Superposition, Thevenin’s and Norton’s, Maximum power transfer Reciprocity theorems	2
1.4	Tellegen’s theorem, Source and Wye-Delta transformation, Duality	1
	Problem solving	4
2	Time Domain Analysis:	
2.1	Transient analysis: Series RL, RC, LC networks, significance of time constant, natural frequency, Resonance.	2
2.2	Steady state sinusoidal analysis of reactive networks	2
	Problem solving	4
3.	Frequency Domain Analysis	
3.1.1	The concept of complex frequency, Network functions of one port, Two Port networks- driving point and transfer functions	1
3.1.2	Poles and Zeros of network functions-their locations and effects on the time and frequency domain responses- Restriction of poles and zeros in the driving point and transfer function, Time domain behaviour from the pole-zero plot.	2
	Problem solving	3

3.2.1	Analysis of two port network: Network parameters- Impedance, admittance, transmission and hybrid, Conversion formulae.	1
3.2.2	Equivalents of T, Π , Ladder, bridged T and Lattice networks, Analysis of interconnected two port networks -parallel, series, and cascade connections, zeros of transmission	2
	Problem solving	3
4.	Synthesis of Networks:	
4.1	Elements of Realizability Theory: Stability-Hurwitz Polynomials-Positive Real Functions	2
4.2.	Elementary Synthesis Procedures – Cauer and Foster forms.	2
	Problem solving	4
4.2.1	Synthesis of One Port and two port Networks: Properties and synthesis of R-L, R-C, L-C Impedance and Admittance Functions.	2
4.2.2	Filters and attenuators	1
	Problem solving	3
	Total Hours	48

Course Designers:

1. Dr.B.Manimegalai
2. Dr.B.Sathyabama

naveenmegaa@tce.edu
sbece@tce.edu



14EC230	SEMICONDUCTOR DEVICES
----------------	------------------------------

Category	L	T	P	Credit
PC	3	0	0	3

Preamble

This is an introduction course to semiconductor devices. The course begins with a discussion on how electron energy bands are formed in semiconductors; followed by discussions on equilibrium statistics of electrons and holes, drift, diffusion currents, and generation and recombination processes. It then examines the principles and operations of essential semiconductor devices used in today's electronics: diodes, light detectors and emitters, bipolar junction transistors and MOSFETs. It includes analysis of small signal model and large signal model of the devices which is the prerequisite for next level courses. The goal is to develop a solid understanding of the device concepts that will be needed in a broad range of areas from semiconductor to circuit (analog, digital and VLSI) design and engineering.

Prerequisite

Nil

Course Outcomes

On the successful completion of the course, students will be able to

CO1 - Apply the fundamental principle of Quantum Mechanics and Solid State Physics to study the parameters of semiconductor materials.	Apply
CO2 - Describe the relationship between electron transport properties and operation of semi conductor devices like Diode, Bipolar Junction Transistors and Field Effect transistors.	Understand
CO3 - Investigate the different configuration and obtain the device small signal model of BJTs and FETs.	Analysis
CO4 - Gain knowledge in the advanced development of low dimensional semiconductor hetero structures and their operation.	Understand
CO5 - Apply the concepts of transistor biasing to study the small signal behaviour of BJT and MOSFET for Amplification application.	Apply

Mapping with Programme Outcomes

COs	PO 1	PO 2	PO 3	PO 4	PO 5	PO 6	PO 7	PO 8	PO 9	PO 10	PO 11	PO 12	PSO 1	PSO 2	PSO 3
CO1	S	M	L	-	-	-	-	-	-	-	-	-	S	-	-
CO2	M	L	-	-	M	-	-	-	-	-	-	-	M	-	-
CO3	S	S	M	L	M	-	-	-	-	-	-	-	S	L	-
CO4	M	L	-	-	-	-	-	-	L	-	-	L	M	-	-
CO5	S	M	L	-	M	-	-	-	-	-	-	-	S	-	-

S- Strong; M-Medium; L-Low

Assessment Pattern

Bloom's Category	Continuous Assessment Tests			Terminal Examination
	1	2	3	
Remember	40	30	20	20
Understand	30	30	30	30
Apply	30	20	30	30
Analyse	0	20	20	20
Evaluate	0	0	0	0
Create	0	0	0	0

Course Level Assessment Questions**Course Outcome 1 (CO1):**

1. Define drift and diffusion.
2. List the various types of semiconductors.
3. Define electron generation and recombination?
4. Determine the total number of energy states in silicon between E_v and $E_v + kT$ at $T = 300$ K.
5. Determine the thermal equilibrium electron and hole concentration in GaAs at $T = 300$ K for the case when the Fermi energy level is 0.30 eV above the valence band energy E_v .
6. Silicon at $T = 300$ K is doped with impurity concentrations of $N_d = 5 \times 10^{16} \text{ cm}^{-3}$ and $N_a = 2 \times 10^{16}$ (a) What are the electron and hole mobilities?
7. The electron concentration in silicon at $T = 300$ K is $n_0 = 5 \times 10^{16} \text{ cm}^{-3}$.
(a) Determine P_{d0} . Is this n- or p-type material?
(b) Determine the position of the Fermi level with respect to the intrinsic Fermi level.

Course Outcome 2 (CO2):

1. Distinguish the features of CE, CB and CC amplifiers.
2. Discuss the effect of temperature and breakdown mechanisms.
3. Distinguish between Small signal and large signal analysis of FETs
4. Describe flat band voltage
5. Distinguish depletion and enhancement MOSFETs

Course Outcome 3 (CO3)

1. Examine the method to obtain the h-parameter for the Common emitter configuration.
2. Derive the expression for input impedance of Common emitter configuration of BJT.
3. Deduce the expression for current gain, voltage gain, input impedance and output impedance for common source MOSFET configuration.
4. Compare the common emitter configuration with common source configuration.
5. Draw the CE, CB and CC BJT configuration.

Course Outcome 4(CO4)

1. What is emitter current crowding?
2. Define subthreshold swing.
3. What do you mean by tunneling?
4. What is meant by high injection?
5. Recall and Compare different gate structures for MOSFETs.

Concept Map

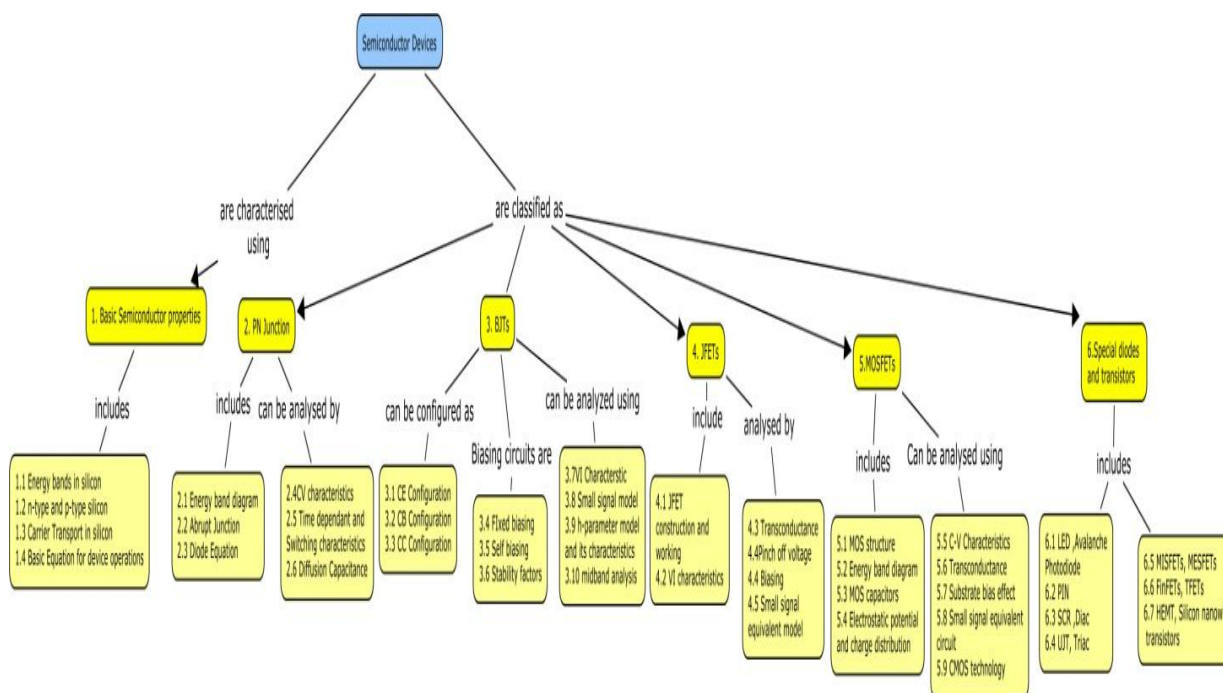

Syllabus

Electrons and Holes in Silicon: Energy bands in Silicon, n-Type and p-Type silicon, Carrier Transport in Silicon, Basic Equation for Device Operation

p-n Junctions: Energy –band Diagrams for a p-n diode, Abrupt Junction, The Diode Equation, Current-Voltage Characteristics, Time dependent and Switching Characteristics, Diffusion Capacitance

Fundamentals of BJT: Transistor Biasing, Fixed Bias Circuit, Stability Factors, Different types of Biasing Circuits, CE, CB, CC Amplifiers, Small Signal –Low Frequency h-Parameter Model, Determination of h-Parameters from Characteristics, Midband Analysis of a BJT single stage amplifiers, Method of Analysis of a Transistor Circuit, Analysis using Simplified Hybrid Model.

JFET: Basic Concepts, Device Characteristics: Transconductance, Pinch off Voltage, Biasing, Small signal Equivalent Circuits

Fundamentals of MOSFETs : Two terminal MOS structure, Energy Band Diagrams, Depletion layer Thickness, Work function Differences, Flat Band voltage, Threshold Voltage, Charge distribution, Surface Potential: Accumulation, Depletion, and Inversion, Electrostatic Potential and charge Distribution in Silicon, Capacitance in MOS Structure. Capacitance - Voltage Characteristics, Basic MOSFET Operation, Current- voltage relationship, Transconductance, Substrate Bias effect, Small Signal Equivalent Circuit, Frequency limitation Factors, cut off frequency and CMOS Technology.

Special diodes and transistors LED, Avalanche Photodiode, PIN, LASERS, MISFETs, MESFETs, TFETs, HEMTs, Silicon Nanowire transistors.

Text Book

1. Donald Neamen, "Semiconductor Physics and Devices", McGraw Hill Pvt Ltd, Fourth Edition, 2011.
2. Lecture Notes Prepared by Dr. N.B.Balamurugan and Dr. S.Rajaram, Dept of ECE, Thiagarajar College of Engineering, 2014.

Reference Books

1. Nandhitha Das Gupta and Amitava Das Gupta "Semiconductor Devices: Modeling and Technology" Prentice Hall of India Pvt Ltd, Fourth Edition, 2004.
2. Adel S. Sedra and Kenneth C.Smith, "Microelectronic Circuits", Oxford University Press, Sixth Edition, 2009.
3. Simon M.Sze and Kwok K.Ng, "Physics of Semiconductor Devices", John wiley & sons, 3rd edition, 2006.
4. Yuan Taur and Tak H.Ning, "Fundamentals of Modern VLSI Devices", Second Edition, Cambridge university Press, 2009.

Course Contents and Lecture Schedule

No.	Topic	No. of Lectures
1.	Electrons and Holes in Silicon	
1.1	Energy bands in Silicon	1
1.2	n-Type and p-Type Silicon, Carrier Transport in Silicon	2
1.3	Basic Equation for Device Operation	2
2.	p-n Junctions:	
2.1	Energy Band Diagrams, Abrupt Junction, The diode Equation	2
2.2	Current-Voltage Characteristics, Time dependent and Switching Characteristics	2
2.3	Diffusion Capacitance	1
3.	Fundamentals of BJTs:	1
3.1	Transistor Biasing, Fixed Bias Circuit, Stability Factors,	1
3.2	Different types of Biasing Circuits	2
3.3	CE, CB, CC Amplifiers, Small Signal –Low Frequency h-Parameter Model, Determination of h-Parameters from Characteristics	3
3.4	Analysis of a BJT single stage amplifiers	2
3.5	Method of Analysis of a Transistor Circuit	1
3.6	Analysis using Simplified Hybrid Model	1
4.	JFETs	
4.1	Basic Concepts, Device Characteristics: Transconductance, Pinch off Voltage	2
4.2	Biasing, Small signal Equivalent Circuits	2
5	Fundamentals of MOSFETs	1
5.1	Two terminal MOS structure: Energy Band Diagrams, Depletion layer Thickness, Work function Differences, Flat Band voltage, Threshold Voltage, Charge distribution	2
5.2	Surface Potential: Accumulation, Depletion, and Inversion, Electrostatic Potential and charge Distribution in Silicon, Capacitance in MOS Structure.	2
5.3	Capacitance -Voltage Characteristics	1
5.4	Basic MOSFET Operation, Current- voltage relationship, Transconductance, Substrate Bias effect	2
5.5	Small Signal Equivalent Circuit, Frequency limitation Factors, cut off frequency	2
5.6	CMOS Technology	1

No.	Topic	No. of Lectures
6	Special diodes and Transistors	
6.1	LED ,Avalanche Photodiode, PIN Diode	1
6.2	LASERs	1
6.3	UJT, Triac	2
6.4	MISFETs, MESFETs	2
6.5	TFETs	1
6.6	HEMT, Silicon nanowire transistors	2

Course Designers:

- | | | |
|----|--------------------------|-----------------------|
| 1. | Dr.N. B. Balamurugan | nbbalamurugan@tce.edu |
| 2. | Mr.V. Vinoth Thyagarajan | vvkece@tce.edu |



14EC240	MATERIALS SCIENCE	Category	L	T	P	Credit
		ES	3	0	0	3

Preamble

The course work aims in imparting fundamental understanding of how the various properties of materials originated from different length scales of electronic and molecular structures that can be used in designing several electronic devices, for example mobile phones, sensors, actuators, antennas and interconnectors. The objective of this course is to emphasis, the real-time physical models in order to understand the various properties of materials by demonstrating the electronic gadgets used day-by-day.

Prerequisite

Nil

Course Outcomes

On the successful completion of the course, the students will be able to

CO1. Explain the physics of thermal expansion, electrical conductivity, ferromagnetic behavior, mechanical hardness, fatigue, creep, and wear at bulk and nano particle level.	Apply
CO2. Explain the chemistry of corrosion and its impact on materials	Apply
CO3. Choose appropriate material for windings of motors and transformers, wiring harnesses for electrical and electronic equipment, signal interconnects on wiring boards, and on-board and off-board connectors.	Apply
CO4. Choose a conductive coating material for a given specified performance requirement in printed wiring boards and EMI shielding.	Understand
CO5. Identify appropriate laminate for making a printed wiring board for given performance requirement and specified technology.	Understand
CO6. Identify appropriate laminate for making a printed wiring board for given performance requirement and specified technology.	Understand
CO7. Select with justification suitable magnetic materials for transformers, motors, linear motors, pulse transformers, electromagnets, relays, magnetostrictive sensors and actuators, and smart antennae.	Apply

Mapping with Programme Outcomes

COs	PO 1	PO 2	PO 3	PO 4	PO 5	PO 6	PO 7	PO 8	PO 9	PO 10	PO 11	PO 12	PSO 1	PSO 2	PSO 3
CO1	S	M	M	L	-	-	-	L	L	-	-	M	M	L	L
CO2	S	S	M	L	-	-	L	L	L	-	-	M	S	L	L
CO3	S	S	M	L	-	-	L	L	L	-	-	M	S	L	L
CO4	S	S	M	L	-	-	L	L	L	-	-	M	S	L	L
CO5	S	S	M	L	-	-	L	L	L	-	-	M	S	L	L
CO6	S	S	M	M	-	-	L	L	L	-	-	M	S	L	L

S- Strong; M-Medium; L-Low

Assessment Pattern

Bloom's Category	Continuous Assessment Tests			Terminal Examination
	1	2	3	
Remember	20	20	20	20
Understand	30	50	80	50
Apply	50	30	0	30
Analyse	0	0	0	0
Evaluate	0	0	0	0
Create	0	0	0	0

Course Level Assessment Questions**Course Outcome 1 (CO1):**

1. Calculate the electrical resistivity of sodium at 0° C. It has 2.533×10^{28} electrons per unit volume and has a mean free time of 3.1×10^{-14} .
2. Calculate the drift velocity of the free electrons with a mobility of $0.0035 \text{ m}^2 \text{ V}^{-1} \text{ S}^{-1}$ in copper for an electric field strength of 0.5 V m^{-1}
3. The intrinsic carrier density at room temperature in Ge is $2.37 \times 10^{19} / \text{m}^3$. If the electron and hole mobilities are 0.38 and $0.18 \text{ m}^2 \text{ V}^{-1} \text{ s}^{-1}$ respectively, calculate the resistivity.
4. Calculate the electron density if the drift velocity of electrons in a metal wire of diameter 5mm is $6 \times 10^{-4} \text{ m/s}$ and the current is 10A.

Course Outcome 2 (CO2):

1. Calculate the maximum or saturation, magnetization that we expect in Iron. The lattice parameter of BCC iron is 2.866 \AA . Compare this value with 2.1 tesla.
2. The Curie temperature of iron is 1043 K. Assume that iron atoms, when in metallic form, have moments of two Bohr magneton per atom. Iron is body-centered cubic with lattice parameter 0.286 nm . Calculate the i) the Curie constant, ii) the saturation magnetization, iii) the Weiss field constant and iv) magnitude of the internal field.
3. A para magnetic material has a magnetic field intensity of 10^4 A/m . If the susceptibility of the material at room temperature is 3.7×10^{-3} calculate the magnetization and flux density in the material

Course Outcome 3 (CO3):

1. The polarizability of NH_3 molecule is found experimentally by the measurement of dielectric constant as $2.5 \times 10^{-39} \text{ coul}^2\text{-m/nt}$ at 300 K and $2.0 \times 10^{-39} \text{ coul}^2\text{-m/nt}$ at 400 K. Calculate for each temperature the polarizability due to permanent dipole moment and due to deformation of molecules.
2. Determine the percentage of ionic polarizability in the sodium chloride crystal, which has the optical index of refraction and the static dielectric constant as 1.5 and 1.6 respectively.
3. A parallel plate capacitor is charged by connecting it to a 90V Battery. The battery is then disconnected and an insulating liquid is poured between the plates to fill the air gap .The potential difference is now 30 V. Calculate the dielectric constant of the liquid.

Course Outcome 4 (CO4):

1. Describe formation of laminar composites.
2. Distinguish between polymer matrix composites and metal matrix composites.
3. Outline the applications of composites pertaining to Electronics Engineering.

Course Outcome 5 (CO5):

1. Illustrate, with suitable examples, the generation of smart materials.
2. Interpret the engineering issues of the conventional shape memory alloys and advanced magnetic shape memory alloys.

3. Underline the applications of Magnetostrictive materials.

Course Outcome 6 (CO6):

1. Identify the properties of Glassy electrolyte used in display devices
2. Memorize the conduction mechanisms of crystalline electrode.
3. Predict the uses of the electrolyte materials in electronic devices

Concept Map

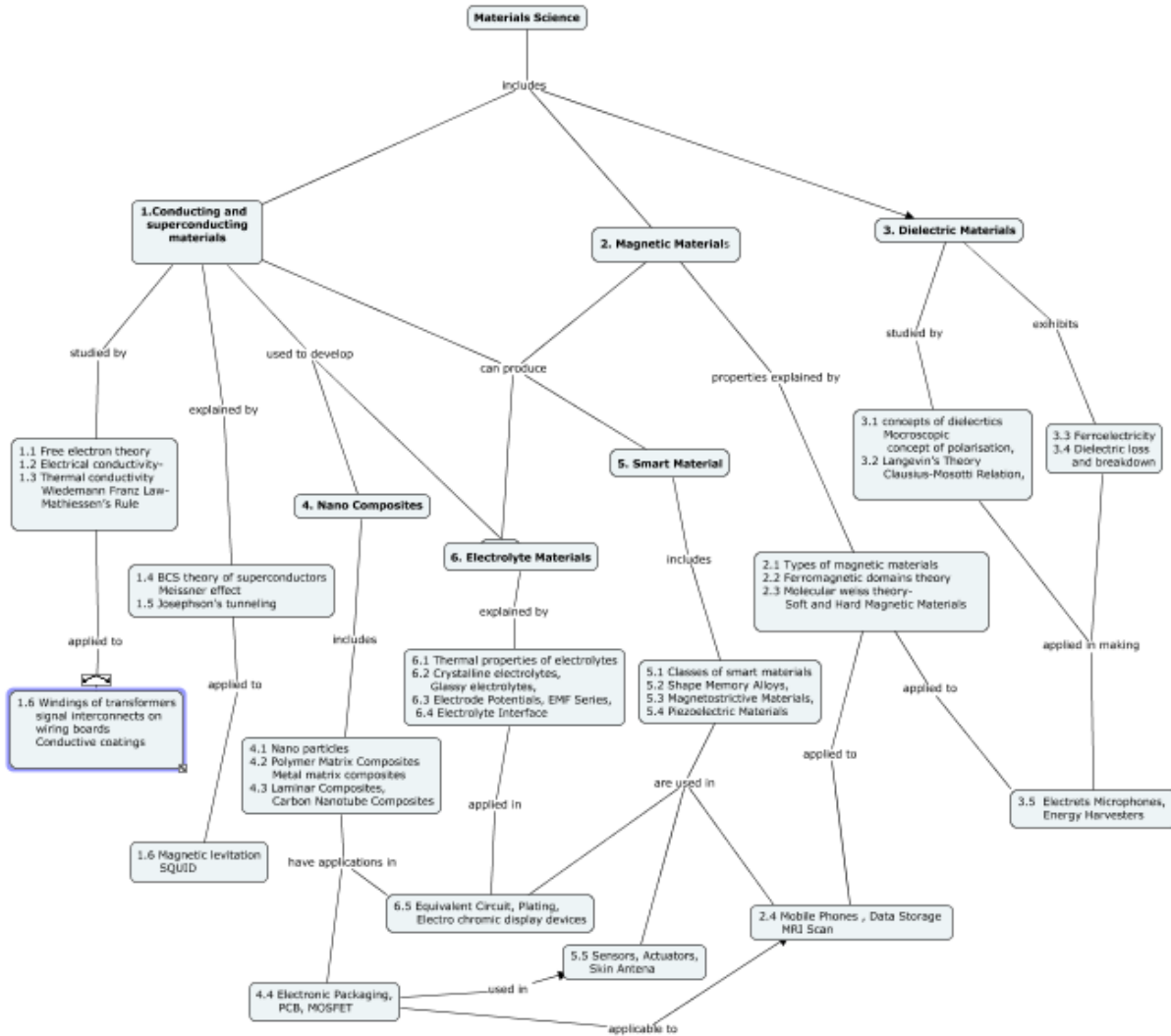

Syllabus

Conducting and Superconducting Materials

Classical Free Electron Theory – Drift Velocity -Electrical conductivity - Thermal conductivity -Wiedemann Franz Law- Mathiessen's Rule- BCS theory of superconductors-Meissner effect Josephson's tunnelling - Applications: Windings of transformers-signal interconnects on wiring boards-Conductive coatings, SQUID-magnetic levitation

Magnetic Materials

Basic Concepts - Classification of Magnetic Materials – Ferromagnetic Domain Theory – Hysteresis-Weiss Molecular Field Theory –Soft and Hard Magnetic Materials - Applications: Mobile Phones -Data Storage - MRI Scan

Dielectric Materials

Basic Concepts of Dielectrics - Microscopic Concept of Polarization – Langevin's Theory - Clausius-Mosotti Relation - Theory of Ferroelectricity - Dielectric loss and breakdown. Applications: Electrets Microphones, Energy Harvesters

Nano Composites

An Overview of Nanoparticles – Polymer Matrix Composites – Metal Matrix Composites - Laminar Composites - Carbon Nanotube Composites - Applications: Electronic Packaging – PCB - MOSFET

Smart Materials

Classes of Smart Materials- Shape Memory Alloys - Magnetostrictive Materials – Piezoelectric Materials- Applications: Sensors- Actuators- Skin Antenna

Electrolyte Materials

Thermal Properties of Electrolytes - Crystalline electrolytes - Glassy electrolytes- Electrode Potentials- EMF Series - Electrolyte Interface - Applications: Equivalent Circuit – Plating- Electro chromic display devices.

Text Books:

1. Materials Science and Engineering- An Introduction, William D. Callister, 6th Edition, John Wiley, USA, 2004.
2. Lecture Notes Prepared by Dr. M. Mahendran and Dr. M. Senthamizhselvi, Dept of Physics, Thiagarajar College of Engineering, 2014.

Reference Books

1. The Science and Engineering of Materials, Donald R. Asklund and Pradeep P. Phule, 5th Edition, Cengage Learning Publisher, USA, 2006
2. Physics of Semiconductor Devices, S.M. Sze and Kwok K. Ng, 3rd Edition, John Wiley, India, 2007.
3. Solid State Physics, S.O.Pillai, 6th Edition, New Age International Publisher, India, 2009
4. Solid State Electrochemistry, Peter. G. Bruce, Cambridge University Press, UK, 2009

Course Contents and Lecture Schedule

Module No.	Topic	No. of Lectures
1	Conducting and Semiconducting Materials	
	Free Electron Theory – Drift Velocity	2
	Mathiessen's Rule -Wiedemann Franz Law	2
	Band structure of Semiconductors	2
	Statics of Electrons and Holes in Intrinsic and Extrinsic semiconductors- Continuity Equation	3
	Hall Effect	1
	Applications: varactor diode - breakdown diode - tunnel diode	2
2	Magnetic and Superconducting Materials	
	Basic Concepts - Classification of Magnetic Materials	2
	Ferromagnetic Domain Theory – Weiss Molecular Field Theory	3
	Soft and Hard Magnetic Materials	1
	Meissner Effect –Josephson's Tunneling-	2
	Applications: Mobile Phones -Data Storage - SQUID-MRI Scan	2
3	Dielectric Materials	
	Basic Concepts of Dielectrics- Microscopic Concept of Polarization	2
	Langevin's Theory- Clausius-Mosotti Relation	2
	Theory of Ferroelectricity	1
	Dielectric loss and breakdown	2
	Applications: Electrets Microphones, Energy Harvesters	1
4	Nano Composites	
	An Overview of Nanoparticles	1
	Polymer Matrix Composites- Metal Matrix Composites	2
	Laminar Composites- Carbon Nanotube Composites	2
	Applications: Electronic Packaging – PCB - MOSFET	1
5	Smart Materials	
	Classes of Smart Materials	1
	Shape Memory Alloys	2
	Magnetostrictive Materials- Piezoelectric Materials	2
	Applications: Sensors- Actuators- Skin Antenna	1
6	Electrolyte Materials	
	Thermal Properties of Electrolytes	1
	Crystalline electrolytes - Glassy electrolytes	1
	Electrode Potentials- EMF Series	2
	Electrolyte Interface	1
	Applications: Equivalent Circuit – Plating- Electro chromic display devices	1

Course Designers:

1. Dr. M. Mahendran
2. Dr. M. Senthamizhselvi

manickam-mahendran@tce.edu
mssphy@tce.edu

14EC250	ENVIRONMENT SCIENCE	Category	L	T	P	Credit
		HSS	3	0	0	3

Preamble

To impart knowledge on various Natural resources, Ecosystems, Bio diversity and to enable the students to understand the impact of pollution by Human activities.

Prerequisite

Nil

Course Outcomes

On the successful completion of the course, students will be able to

CO1	Explain why an ecosystem is an open system	Understand
CO2	Explain how an ecosystem is characterized by trophic structure, zonation, diversity, production and decomposition, information networks, footprint, interaction between natural and techno eco subsystems.	Understand
CO3	Analyze specific ecosystems like a pond, watershed and agro-ecosystem.	Analyze
CO4	Trace the energy flows through an ecosystem by way of solar radiation, productivity, food chains and food webs, metabolism and size of individuals, carrying capacity, complexity, sustainability, net energy, energy futures and money.	Understand
CO5	Trace how an ecosystem is governed by different biogeochemical cycles, including nitrogen, phosphorous, sulfur, carbon, hydrologic, non-essential elements and nutrient cycles, and watershed	Understand
CO6	Analyze the biogeochemical cycles in terms of turnover and residence times and recycling pathways.	Analyze
CO7	Explain how global climatic changes occur.	Apply
CO8	Analyze the fresh water ecosystem	Analyze

Mapping with Programme Outcomes

COs	PO 1	PO 2	PO 3	PO 4	PO 5	PO 6	PO 7	PO 8	PO 9	PO 10	PO 11	PO 12	PSO 1	PSO 2	PSO 3
CO1	S	M	L	L	-	-	-	L	L	-	-	M	M	L	L
CO2	S	M	M	L	-	-	-	L	L	-	-	M	M	L	L
CO3	S	S	M	L	-	-	-	L	L	-	-	M	S	L	L
CO4	S	M	M	L	-	-	-	L	L	-	-	M	M	L	L
CO5	S	S	M	L	-	-	-	L	L	-	-	M	S	L	L
CO6	S	S	M	M	-	-	-	L	L	-	-	M	S	L	L
CO7	S	S	M	M	-	-	-	L	L	-	-	M	S	L	L
CO8	S	S	M	L	-	-	-	L	L	-	-	M	S	L	L

S- Strong; M-Medium; L-Low

Assessment Pattern

Bloom's Category	Continuous Assessment Tests			Terminal Examination
	1	2	3	
Remember	20	20	20	20
Understand	40	40	40	40
Apply	40	40	40	40
Analyse	-	-	-	-

Evaluate	-	-	-	-
Create	-	-	-	-

Course Level Assessment Questions

Course Outcome 1 (CO1):

1. What are biotic and non-biotic components of an eco system?
2. Define grazing and detritus food chain?
3. Explain a simple food chain in a small lake?
4. With a help of examples, explain the different types of ecological pyramids?

Course Outcome 2 (CO2):

1. What is ecological imbalance?
2. List few major human activities leading to environmental imbalance.
3. How do increased agricultural practices bring environmental imbalance
4. What is the need for industrialization and how industrialization lead to environmental imbalances?

Course Outcome 3 (CO3)

1. What are the practices one could follow to conserve water in home?
2. How could you adopt 3R for efficient water management in an industry?
3. How would you bring down water losses and waste in a water supply system to a building?
4. How will you achieve energy conservation using renewable energy resources?

Course Outcome 4 (CO4)

1. Elaborate consumptive and productive uses of Biodiversity with examples.
2. Discuss various factors influencing loss of bio diversity in detail.
3. Express your ideas on the significance of bio diversity?
4. Explicate the ways of existing bio diversity conservation practices.

Course Outcome 5 (CO5)

1. Explain the sources, causes of air pollution and derive its consequences in both plant and animals.
2. Give a brief account on Water pollution and its ill effects.
3. Describe ozone layer depletion and list few of its implication in the environment?
4. Discuss how modern agriculture bring fertilizer and pesticide problems?

Course Outcome 6 (CO6)

1. How will you combat global warming and acid rain?
2. Suggest few practices for waste land reclamation.
3. As an environmental consultant, suggest various ways for the control of noise pollution.
4. Suggest few immobilization and disposal methods for low active solid and concentrated liquid waste from nuclear reactors.

Course Outcome 7 (CO7)

1. Why do you think MINAS and RoHS standards are necessary for production industry?
2. As an engineer, what do you expect an environmental audit report should encompass?
3. Of many central laws on the protection of environment and chemical safety, which law, do you think deals with abatement of pollution of rivers and streams?
4. Justify how industrial zoning can prevent air pollution?

Concept Map

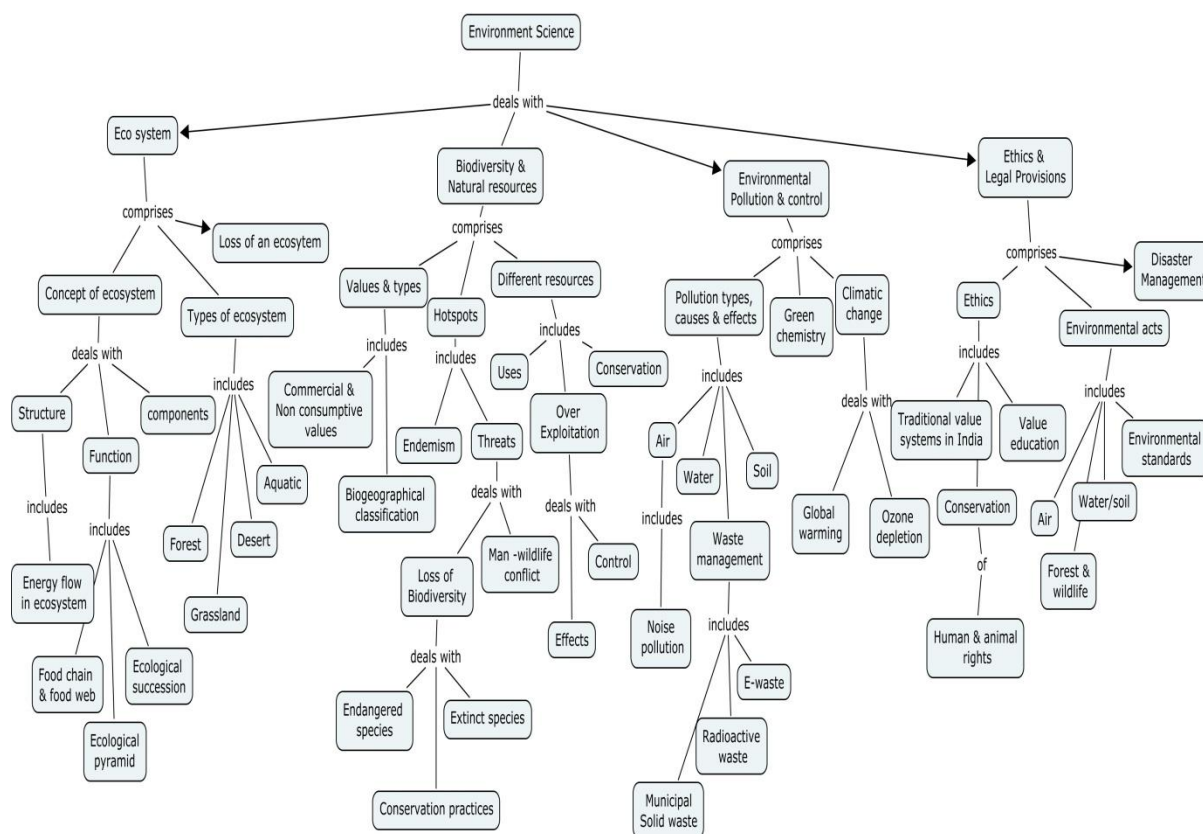

Syllabus

Multidisciplinary nature of environment- need for public awareness-Eco-system-Concept, structure, function, components, laws of Ecology, Energy flow in eco system - Food chains, food webs-Ecological pyramids-Ecological succession. Types of eco system- Forest, Grass Land, Desert, Aquatic ecosystem, Loss of ecosystem and its estimation.

Biodiversity and its conservation-biodiversity types, bio-geographical classification, Values of biodiversity – Hot spots of biodiversity-threats to biodiversity-Biodiversity Indices-Endangered and endemic species- conservation of bio-diversity, Natural resources-Forest-Water-Food-Energy-soil-uses, over exploitation, effects and control. Role of individual in the conservation of natural resources.

Environmental pollution- air, water, soil and noise pollution-causes, types, effects and control measures – Nuclear Pollution- Radioactive waste Management- Solid waste management-causes, effects and control measures. Recycling of municipal solid wastes and e-wastes - Micro-organism and degradation of pollutants, Water conservation-Rainwater harvesting-global warming-climate change and its effect on Environment – acid rain - ozone layer depletion-Green Chemistry - Hydrogen vs Carbon economy-

Social Issues and the environment-RoHS compliance and WEEE directives in different countries -Environmental Ethics - sustainable development - Future aspects - Human and Animal rights-conservation of ethics and traditional value systems of

India - Legal provisions-Environmental acts – Air, water, soil and forest and wildlife - Population explosion and environment- family welfare programme - Value education - Disaster management- floods, earthquake, tsunami and landslides

Text Books

1. Santhosh Kumar Garg, Rajeswari Garg and Ranjani Garg, 'Environmental Science and Ecological Studies', Khanna Publishers, Second Edition, New Delhi, 2007
2. Suresh. K. Dhameja, Environmental Science and Engineering, S. K. Kataria & Sons, 2009
3. Kaushik, Anubha & Kaushik, C.P. Environmental Science and Engineering, New Age International (P) Ltd. Publisher, New Delhi, 2006
4. Bharucha Erach (ed) Text Book of Environmental Studies., University Press (India) Pvt. Ltd., 2007

Reference Books

1. Clair N Sawyer, Perry L. McCarty & Gene. F.Parkin, Chemistry for Environmental Engineering, Tata McGraw Hill, Fourth edition, 2000

Course Contents and Lecture Schedule

Module No.	Topic	No. of Lectures
1.0	Multidisciplinary nature of environment and need for public awareness	1
1.1	Eco-system Concept, structure, function and components	1
1.2	Laws of Ecology and Energy flow in eco system	1
1.3	Food chains, food webs	1
1.4	Ecological pyramids	1
1.5	Ecological succession	1
1.6	Types of eco system	1
1.7	forest, grass land, desert, aquatic ecosystem, Loss of ecosystem and its estimation	2
2.1	Biodiversity and its conservation	2
2.2	biodiversity types, bio-geographical classification, Values of biodiversity	2
2.3	Hot spots of biodiversity, threats to biodiversity	1
2.4	Biodiversity Indices-Endangered and endemic species	1
2.5	Conservation of biodiversity	1
2.6	Natural resources, Forest, Water, Food, Energy, soil, - Uses, over exploitation, effects and control.	2
2.7	Role of individual in the conservation of natural resources	1
3.1	Environmental pollution- air, water, soil and noise pollution-causes, types, effects and control measures -	3
3.2	Nuclear pollution and radioactive waste Management	1
3.3	Solid waste management-causes, effects and control measures	2
3.3	Recycling of municipal solid wastes and e-wastes	1
3.4	Micro-organism and degradation of pollutants, Water conservation	1
3.5	Global warming-climate change and its effect on Environment – acid rain - ozone layer depletion	2
3.6	Green Chemistry and Hydrogen vs Carbon economy	2
4.1	Social Issues and the environment-Environmental Ethics - sustainable development - Future aspects	2
4.2	Human and Animal rights-conservation of ethics and traditional value systems of India	1

Module No.	Topic	No. of Lectures
4.3	Legal provisions-Environmental acts	2
4.4	Population explosion and environment- family welfare programme	1
4.5	Value education	1
4.6	Disaster management- floods, earthquake, tsunami and landslides	2

Course Designers:

1.	Dr.S.Balaji	sbalaji@tce.edu
----	-------------	--



14EC270	DIGITAL LOGIC CIRCUIT DESIGN	Category	L	T	P	Credit
		PC	2	0	1	3

Preamble

14EC270 is a study of basic digital logic circuit design and implementation. The course aims at Circuit schematic development, Computer modelling, Simulation of digital system and verifies their functionality using the Hardware description Language (Verilog). Experiments explore designs with combinational and sequential logic. Students work through design activities, which include testing, troubleshooting and documentation.

Prerequisite

Nil

Course Outcomes

On the successful completion of the course, students will be able to

CO1	Know what digital systems are, how they differ from analog systems and why it is advantageous to use digital systems in many applications	Understand
CO2	To apply the principles of Boolean algebra to manipulate and minimize logic expressions	Apply
CO3	Design and debug basic combinatorial and sequential logic circuits	Apply
CO4	Use state machine diagrams to design finite state machines using sequential circuits	Apply
CO5	<i>Design, debug and verify simple digital circuits and systems with the aid of computer software including Verilog, schematic capture tools and simulation tools</i>	Evaluate

Mapping with Programme Outcomes

COs	PO 1	PO 2	PO 3	PO 4	PO 5	PO 6	PO 7	PO 8	PO 9	PO 10	PO 11	PO 12	PSO 1	PSO 2	PSO 3
CO1	M	-	-	-	-	-	-	-	-	-	-	L	L	L	L
CO2	S	M	-	-	-	-	-	-	-	-	-	-	L	-	-
CO3	S	S	M	-	S	-	-	-	M	L	-	L	M	L	-
CO4	S	S	S	L	S	L	L	-	S	M	-	M	M	M	L
CO5	S	S	S	-	S	M	L	-	S	S	-	M	M	M	L

S- Strong; M-Medium; L-Low

Assessment Pattern

Bloom's Category	Continuous Assessment Tests			Terminal Examination
	1	2	3	
Remember	20	0	Practical	10
Understand	30	20		10
Apply	50	40		40
Analyse	0	40		40
Evaluate	0	0		0
Create	0	0		0

Course Level Assessment Questions**Course Outcome 1 (CO1):**

1. Differentiate between analog and digital processing.
2. Describe the format of numbers of different radices?
3. Convert $(7AD)_h$ to octal.
4. Define : Moore's Law
5. Convert $(111010110)_2$ to Decimal.
6. List out the applications of digital information processing.

Course Outcome 2 (CO2):

1. Use DeMorgan's Theorems to simplify the expressions: $\overline{(a + c)}$ $\overline{(b + c)}$
2. For each of the following Boolean expressions, give: the truth Table
 - a. $(a + (b + c)) (c + (a + b + d) (a + b + d))$
 - b. $(c + a b) (c + (a + d) (b + d)) (c + (a + b) (b + d))$
 - c. $w y + w x y + w x z$
3. For each of the above Boolean expressions, give the Karnaugh map.
4. For each of the above Boolean expressions, give the MSP expression (Show groupings)
5. For each of the above Boolean expressions, give the MPS expression (Show groupings)

Course Outcome 3 (CO3)

1. Implement the function $f(w_1, w_2, w_3) = \sum m(1, 2)$ using 4 to 1 multiplexer.
2. Design a full adder circuit using decoder and multiplexer.
3. Design a logic diagram of a addition/subtraction. Use a control variable w and a circuit that functions as a full adder when $w = 0$, as a full subtractor when $w = 1$.
4. Show how the function $f = w_2 w_3 + w_1 w_2$ can be implemented using 2:1 mux?
5. Construct the decomposed full adder circuit using half adder circuit.

Course Outcome 4 (CO4)

1. Design a 3-bit counter that can count either up or down on the rising edge of the clock. There are three input signals: a clock signal, a reset signal, and a signal to indicate whether the counter should count up or count down. If the up/down signal is high, the counter will count up, if the input signal is low, the counter will count down. On reset, the count will return to zero.
 - (a) Give the state transition table for this FSM.
 - (b) Use K-maps to find the MSP expressions to be used as inputs to 4 to the D flip-flops.
 - (c) Draw the logic diagram for this counter.
2. Design a FSM for a single input and single output Moore type FSM that produces an output of 1 if an input sequence it detects either 110 or 101 pattern. Overlapping sequences should be detected.

3. Design a control mechanism for the finite state machine that swaps the contents of registers R1 and R2 can be realized using a shift register.
4. Design a synchronous counter that counts pulses on line w and displays count in sequence like 0, 4, 9, 6, 2, 0, 4..... Use JK flip-flop in circuit.
5. Design a serial adder Mealy type FSM.

Course Outcome 5 (CO5)

1. Design and simulate an asynchronous circuit that meets the following specifications .The circuit has an input w and an output z, such that when pulses are applied to w, the output z is equal to 0 if the number of previously applied pulses is even and z is equal to 1 if the number of pulses is odd.
2. Design and simulate a Arithmetic and Logic Unit using Verilog HDL.
3. Create a Verilog entity named *4to1mux* that represents a 4 to 1 Multiplexer using if-then-else statement. Create a second entity named *16to1mux* that represents 16to1 Multiplexer using two instances of the 4to1mux.Write VHDL code for 16 to 1 MUX.
4. Design and simulate a simple microprocessor unit.

Concept Map

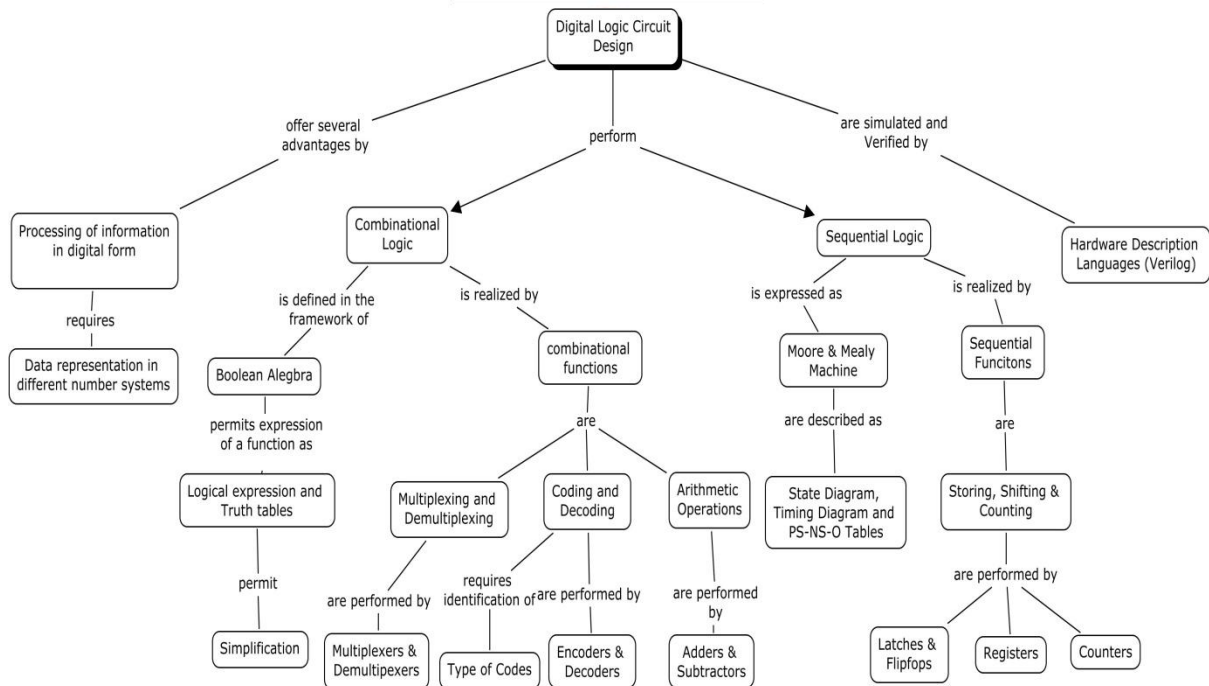

Syllabus

Theory:

Digital Information Processing: About Digital Design, Analog versus Digital, Advantages of processing information in digital form, Digital Devices, Electronic Aspects of Digital Design. Software Aspects of Digital Design. Number systems: Positional Number Systems. Octal and Hexadecimal Numbers. General Positional-Number-System Conversions.

Combination Logic: Boolean algebra, Logic Expressions and Truth Tables, Logic Minimization using karnaugh Map and Quine Mc-Cluskey Method.

Combinational Functions: Multiplexing and De-multiplexing, Types of Codes: Binary Codes for Decimal Numbers, Gray Code, Encoding and Decoding: Arithmetic Operations: Adders: Look Ahead Adder, Subtractors and Multipliers: Booth Multiplier

Sequential Logic: Clocked Synchronous state machine analysis, Moore and Mealy Machines, Designing State Machines Using State Diagrams.

Sequential Functions: Bistable elements, Latches, Flip-Flops, Registers: SISO, SIPO, PISO and PIPO, and up/down Counters.

Practical:

Software Experiments using HDL

1. Design and Simulation of Full adder circuit using Gate level modeling.
2. Design and Simulation of 2X2 multiplier circuit using structural level modeling.
3. Design and Simulation of 8 to 1 Multiplexer circuit using behavioural level modeling.
4. Design and Simulation of up-down counter using behavioural level modeling.

Hardware Experiments

1. Implementation of Full Adder using
 - (a) Decoder
 - (b) Multiplexer
2. Implementation of various types of code converters like binary to gray code converter and seven segment display code converter.
3. Implementation of SR, D, T, and JK flipflops and basic counters.
4. Implementation of odd and even parity generators.

Text Book

1. John F. Wakerly, "Digital Design Principles & Practices", 4th edition, Prentice-Hall, 2005

Reference Books

1. M. Morris Mano and Michael D. Ciletti, "Digital Design: With an Introduction to the Verilog HDL", 5th Edition, Prentice Hall 2012.
2. Stephen D. Brown, and Zvonko Vranesic, "Fundamentals of Digital Logic with Verilog Design, 2nd Edition," McGraw Hill, June, 2007
3. J.Baskar, "A Verilog HDL Primer", Third Edition, 2005, Star Galaxy publishing
4. William Kleitz, "Digital Electronics: A Practical Approach with VHDL", Ninth Edition, Pearson, 2002.
5. Gideon Angholz, Abraham Kandel, Joe L. Mott Digital logic design, 1988.
6. Charles H.Roth and Larry.N.Hanny, "Fundamentals of Logic Design", Sixth edition, Cengage Learning, 2010.

Course Contents and Lecture Schedule

Module No.	Topic	No. of Lectures
1.	Digital Information Processing	
1.1	About Digital Design, Analog versus Digital, Advantages of processing information in digital form	1
1.2	Digital Devices, Electronic Aspects of Digital Design. Software Aspects of Digital Design	1
1.3	Number systems: Positional Number Systems. Octal and Hexadecimal Numbers. General Positional-Number-System	1

Module No.	Topic	No. of Lectures
	Conversions	
2.	Combinational Logic	
2.1	Boolean Algebra	1
2.2	Logic Expressions and Truth Tables	2
2.3	Logic Minimization using Karnaugh Map and Quine Mc-Cluskey Method	3
3.	Combinational Functions	
3.1	Multiplexing and Demultiplexing	
3.1.1	Multiplexers	1
3.1.2	Demultiplexers	1
3.2	Encoding and Decoding	
3.2.1	Types of Codes: Binary Codes for Decimal Numbers, Gray Code	1
3.2.2	Encoders	1
3.2.3	Decoders	1
3.3	Arithmetic Operations	
3.3.1	Adders and Subtractors	1
4.	Synchronous Sequential Logic	
4.1	Clocked Synchronous state machine analysis	1
4.2	Moore and Mealy Machines	2
4.3	Designing State Machines Using State Diagrams	2
5.	Sequential Function	
5.1	Bi-stable elements, Latches and Flip-flops	1
5.2	Registers: SISO, SIPO, PISO and PIPO	2
5.3	Up/Down Counters	2
6.	<i>Design and simulation of combinatorial and sequential logic circuits using HDL.</i>	24
Total		48

Course Designers:

1. Dr.S.Rajaram rajaram_siva@tce.edu
2. Dr. D.Gracia Nirmala Rani gracia@tce.edu

14EC280	CIRCUITS AND DEVICES LAB	Category	L	T	P	Credit
		PC	0	0	1	1

Preamble

The goals are to supplement the theory courses 14EC230 Semiconductor Devices and 14EC220 Passive Network Analysis and Synthesis to assist the students in obtaining a better understanding of the operation of electronic circuits and to provide experience in an analysing and test of electronic circuits using simulation software as well as lab instruments.

Prerequisite

Nil

Course Outcomes

On the successful completion of the course, students will be able to

CO1	Construct the microelectronic circuits.	Analyze
CO2	Design the diode circuits and single stage BJT and MOSFET amplifier circuits for given specifications.	Apply
CO3	Simulate the microelectronic circuits using P-Spice software.	Apply
CO4	Measure and record the experimental data, analyze the results, and prepare a formal laboratory report.	Apply
CO5	Analyze the microelectronic circuits.	Analyze

Mapping with Programme Outcomes

COs	PO 1	PO 2	PO 3	PO 4	PO 5	PO 6	PO 7	PO 8	PO 9	PO 10	PO 11	PO 12	PSO 1	PSO 2	PSO 3
CO1	S	M	L	-	M	-	-	M	S	-	-	-	S	-	S
CO2	S	M	L	-	M	-	-	-	S	M	-	-	S	-	-
CO3	S	M	L	-	S	-	-	M	S	L	-	-	S	L	L
CO4	S	M	L	-	S	-	-	M	S	S	-	-	S	L	S
CO5	S	S	M	-	S	-	-	-	S	S	-	-	S	L	L

S- Strong; M-Medium; L-Low

List of Experiments

1. Construct and Analysis of T, II and impedance Matching Networks using Network Theorems.
2. Analysis of Wheatstone-Bridge Circuit.
3. Design and analysis of First Order RC and LC Circuits as LPF & HPF.
4. Determination of Q factor of a given LC circuit.
5. Analyze the Device Behaviour of Semiconductor Diodes and FETs.
6. Analyze the Device Behaviour of Bipolar Junction Transistor
7. Analyze the Device Behaviour of FETs.
8. Design and Analysis of Voltage Regulators.
9. Design and analysis of Rectifiers and Filters.
10. Analyze the characteristics of LED, LDR, Photo Diode and PIN.

Course Designers:

1. Dr.N.B.Balamurugan nbbalamurugan@tce.edu
2. Mr.V.Vinoth Thyagarajan vvkece@tce.edu

14EC290	WORKSHOP	Category	L	T	P	Credit
		ES	0	0	1	1

Preamble

This is the foundation practical course for the students of circuit branches (EEE, ECE, CSE and IT). The aim of this course is to impart fundamental hands-on skill in carrying out experiments at higher semester practical courses.

Prerequisite

Nil

Course Outcomes

On the successful completion of the course, students will be able to:

CO1	Identify various basic electronic components	Understand
CO2	Understand specifications of basic electronic components.	Understand
CO3	Understand PCB terms and definitions	Understand
CO4	Develop PCB layout for the given circuit schematic	Apply
CO5	Fabricate PCB for the given circuit	Apply
CO6	Solder and desolder the respective components on PCB	Apply

Mapping with Programme Outcomes

COs	PO 1	PO 2	PO 3	PO 4	PO 5	PO 6	PO 7	PO 8	PO 9	PO 10	PO 11	PO 12	PSO 1	PSO 2	PSO 3
CO1	M	L	-	-	-	-	-	L	L	L	-	-	M	-	-
CO2	M	L	-	-	-	-	-	L	L	L	-	-	M	-	-
CO3	M	L	-	-	-	-	-	L	L	L	-	-	M	-	-
CO4	S	M	L	-	M	-	-	M	M	M	-	L	S	-	M
CO5	S	M	L	-	L	-	-	M	M	M	-	L	S	-	M
CO6	S	M	L	-	L	-	-	M	M	M	-	L	S	-	M

S- Strong; M-Medium; L-Low

List of Experiments**Electrical and Electronics Engineering:**

1. Realization and Discrimination of fuses and Circuit breakers
2. Earthing practices and its significances
3. Wiring practices and testing
4. Functionalities of RPS/AFO/CRO
5. Functionalities and Selection of Analog and Digital meters

Electronics and Communication Engineering:

1. Identifying electronic components and understanding PCB glossary
1. Conversion of schematic into PCB layout and PCB fabrication
2. Practicing of soldering and desoldering

Computer Science and Engineering:

1. Practice on different DOS and Unix commands. Basic configuration management of Windows operating system.
2. Practice on designing and preparing reports using word, Power-point and Excel applications.

Information Technology:

1. PC Assembling and troubleshooting

- Assembling a SMPS in a cabinet, fixing a processor in a mother board, assembling RAM in a motherboard, pinning a cooling fan in a mother board
- Assembling a hard disc drive in a cabinet, assembling a CD/DVD ROM in a cabinet, fixing motherboard in a cabinet.
- Connecting the cables from the SMPS to motherboard, hard disk, drives & etc, establishing data connection for to motherboard, hard disk, drives. Fixing wires for power restart switches, fixing wires for power & HDD LED's, fixing wires for external USB and Audio connections.
- Installation and Configuration of CMOS Setup, HDD, CDROM, Keyboard, Mouse, Printers, Monitor, and SMPS.
- Hardware trouble shooting.

2. Software Installation and Internet configuration

- Operating System and Software Installation.
- Configuration of Internet.

Course Designers:

- | | |
|----------------------|------------------------------|
| 1. Dr.V.Saravanan | vseee@tce.edu |
| 2. Dr.V.Prakash | vpeee@tce.edu |
| 3. Dr.P.S.Manoharan | psmeee@tce.edu |
| 4. Dr.K.Hariharan | khh@tce.edu |
| 5. Mr. M.Sivakumar | mस्कse@tce.edu |
| 6. Mr.C.Senthilkumar | स्कse@tce.edu |
| 7. Mr. M.Thangavel | thangavelmuruganme@gmail.com |

CURRICULUM AND DETAILED SYLLABI

FOR

THIRD SEMESTER

B.E. DEGREE PROGRAMME

IN

ELECTRONICS AND COMMUNICATION ENGINEERING



FOR THE STUDENTS ADMITTED IN THE

ACADEMIC YEAR 2014-15 ONWARDS

DEPARTMENT OF ELECTRONICS AND COMMUNICATION ENGINEERING

THIAGARAJAR COLLEGE OF ENGINEERING

(A Government Aided ISO 9001:2008 certified Autonomous Institution affiliated to Anna University)

MADURAI – 625 015, TAMILNADU

Phone: 0452 – 2482240, 41

Fax: 0452 2483427

Web: www.tce.edu

14EC310	PARTIAL DIFFERENTIAL EQUATIONS AND LINEAR ALGEBRA	Category	L	T	P	Credit
		BS	2	1	0	3

Preamble

Partial differential equation (PDE) is a differential equation that contains unknown multivariable functions and their partial derivatives. Its generally arise from the mathematical formulation of physical problems. Subject to certain given conditions, called boundary conditions, solving such an equation is known as solving a boundary value problem. It is applied in many Engineering field like Electromagnetic field, Electronics circuit and fiber optics. The PDE can be solved using various mathematical techniques.

The operations of addition and scalar multiplication are used in many diverse contexts in mathematics. These operations follow the same set of arithmetic rules. The general theory of mathematical systems involving addition and scalar multiplication has the applications to many areas of communication systems. Mathematical systems of this form are called Vector spaces or linear spaces. Linear Algebra is used in analog and digital communication system.

Prerequisite

Nil

Course Outcomes

On the successful completion of the course, students will be able to

CO1 : Predict PDE by eliminating arbitrary constants or functions	Understand
CO2: Use suitable method to solve first order and higher order PDE	Apply
CO3: Solve the hyperbolic and elliptic equations using Fourier series.	Apply
CO4: Compute the dimension of row space and column space for the given vector space.	Apply
CO5: Construct the least square fit and orthonormal basis	Apply
CO6: Identify whether the given mapping is linear transformation or not	Understand

Mapping with Programme Outcomes

COs	PO 1	PO 2	PO 3	PO 4	PO 5	PO 6	PO 7	PO 8	PO 9	PO 10	PO 11	PO 12	PSO 1	PSO 2	PSO 3
CO1	M	-	-	-	-	-	-	-	-	-	-	-	M	-	-
CO2	S	-	-	-	-	-	-	-	-	-	-	-	M	-	-
CO3	S	-	-	-	-	-	-	-	-	S	-	S	M	-	M
CO4	S	-	-	-	-	-	-	-	-	-	-	-	M	-	-
CO5	S	-	-	-	-	-	-	-	-	S	-	S	M	-	M
CO6	M	-	-	-	-	-	-	-	-	-	-	-	M	-	-

S- Strong; M-Medium; L-Low

Assessment Pattern

Bloom's Category	Continuous Assessment Tests			Terminal Examination
	1	2	3	
Remember	10	10	10	0
Understand	30	30	30	30
Apply	60	60	60	70
Analyse	0	0	0	0
Evaluate	0	0	0	0
Create	0	0	0	0

Course Level Assessment Questions**Course Outcome 1(CO1):**

1. Predict PDE by eliminating arbitrary constant a and b from $z = (x^2 + a)(y^2 + b)$
2. Predict PDE by eliminating arbitrary function from $z = f(x^2 + y^2)$
3. Predict PDE by eliminating arbitrary function from $z = f(x) + e^y g(x)$

Course Outcome 2 (CO2):

1. Solve $z = px + qy + \sqrt{p^2 + q^2}$
2. Solve $(D^2 + 3DD' - 4D'^2)z = (e^{2x} - e^{-y})^3$
3. Solve $(x^2 - yz)p + (y^2 - xz)q = (z^2 - xy)$

Course Outcome 3 (CO3):

1. A tightly stretched string with fixed end points $x=0$ and $x=l$ is initially at rest in its equilibrium position, If the string is set vibrating by giving each point a velocity $kx(l-x)$. Find the displacement of the string at any time.
2. The points of trisection of a string are pulled aside through the same distance on opposite side of the position of equilibrium and the string is released from rest. Derive an expression for the displacement of the string at subsequent time and show that the midpoint of the string always remains at rest.
3. Calculate the steady state temperature distribution in a rectangular plate of sides a and b insulated at the lateral surfaces and satisfying the boundary conditions: $u(0, y) = 0$, $u(a, y) = 0$, for $0 < y < b$; $u(x, b) = 0$ and $u(x, 0) = x(a - x)$, for $0 < x < a$.
4. An infinite long plate is bounded by two parallel edges and an end at right angles to them. The breadth is π . This end is maintained at a constant temperature u_0 at all points and the other edges are at zero temperature. Find the steady state temperature at any point (x, y) of the plane.

Course Outcome 4 (CO4):

1. Show that P_n is a vector space .
2. Show that null space of matrix is a subspace
3. Compute the basis of row space of matrix A and basis of $N(A)$ where

$$A = \begin{bmatrix} 1 & 2 & -1 & 1 \\ 2 & 4 & -3 & 0 \\ 1 & 2 & 1 & 5 \end{bmatrix}$$

Course Outcome 5 (CO5):

1. Calculate an orthonormal basis for P_3 if its inner product on P_3 is defined by

$$\langle p, q \rangle = \sum_{i=1}^3 p(x_i)q(x_i) \quad \text{where } x_1 = -1, x_2 = 0, x_3 = 1.$$

2. Solve the system of equation by method of least square be defined by
 $-x_1 + x_2 = 10; 2x_1 + x_2 = 5; x_1 - 2x_2 = 20.$

3. Apply Gram-schmidt algorithm to set be defined by $\{1, t, t^2\}$ to obtain the orthonormal basis provided V be the vector space with inner product be defined by

$$\langle f, g \rangle = \int_{-1}^1 f(x)g(x)dx.$$

Course Outcome 6 (CO6):

1. Identify whether or not $L: R^3 \rightarrow R^3$ be defined by $L(x_1, x_2) = (x_1, x_1 + x_2, x_1 + x_2 + x_3)$ is linear transformation
2. Discuss about the linear transformation $L: R^2 \rightarrow R$ defined by $L(x_1, x_2) = \sqrt{x_1^2 + x_2^2}$
3. Predict the matrix of linear transformation $L: R^2 \rightarrow R^2$ defined by $L(x_1, x_2) = (x_2, x_1 + x_2)$

Concept Map

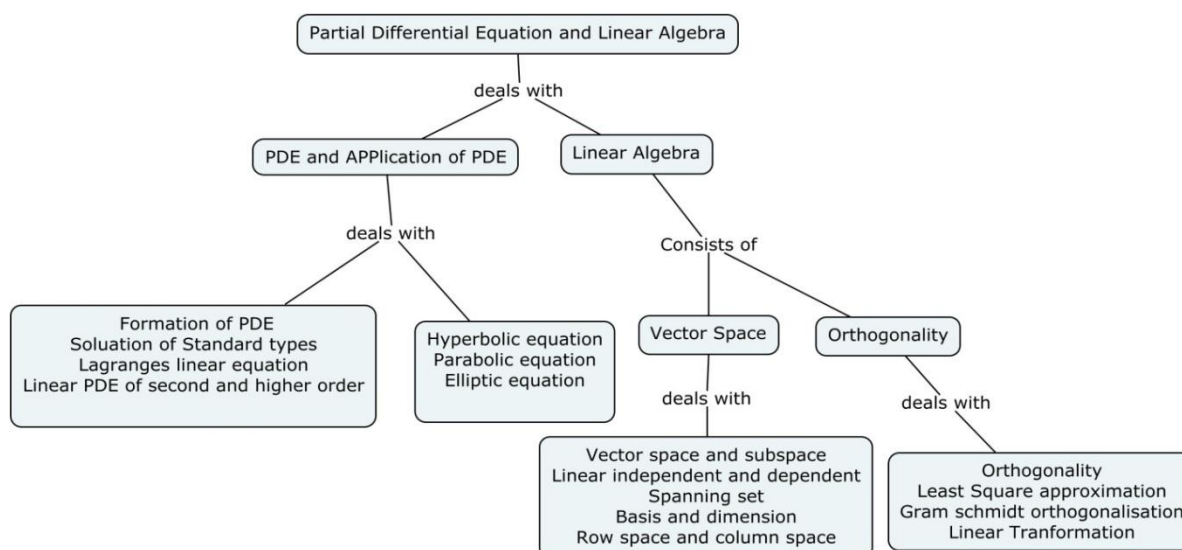

Syllabus

Partial Differential Equations: Formation, Solution of standard types of first order equations, Lagrange's linear equation, Linear partial differential equations of second and higher order with constant coefficient.

Boundary Value Problems: Classification of Second Order linear partial differential equations, Separation of variable method, Hyperbolic equation- Wave equation, Solution by Fourier Series, Parabolic equation-Introduction to one dimensional heat equation, Elliptic equation-Laplace equation in two dimensional heat equation in Cartesian Co-ordinates and Polar Co-ordinates, Solution by Fourier Series, Poisson equation.

Vector Space and Subspace: Introduction to vector space and subspace, Linear independent and dependent, spanning set, Basis and dimension, Row space and column space.

Orthogonality and Linear Transformation: Introduction to orthogonality Least square approximation, Orthogonal basis and Gram Schmidt orthogonalisation, Linear transformation and its matrix representation.

Text Books

1. Grewal.B.S, Higher Engineering Mathematics, Khanna Publications, 42nd Edition, 2012.
2. Steven .J.Leon-"Linear Algebra with Application", Prentice Hall of India Pvt.Ltd, New Delhi, 8th edition, 2010.

Reference Books:

1. Veerarajan .T, "Engineering Mathematics", 3rd Edition. , Tata McGraw Hill, New Delhi, 2004
2. Kreyszig,E., "Advanced Engineering Mathematics", John Wiley and Sons,(Asia)Pte Ltd., Singapore.2006.
3. Gilbert Strang, "Introduction to Linear Algebra", 4th edition Wellesley- Cambridge Press, 2009.

Course Contents and Lecture Schedule

Module No.	Topic	No.of Lectures
1	Partial Differential Equations	
1.1	Formation	1
	Tutorial	1
1.2	Solution of standard types of first order equations	2
1.3	Tutorial	1
1.3	Lagrange's linear equation	1
	Tutorial	1
1.4	Linear PDE of second and higher order with constant coefficient	2
	Tutorial	2
2	Boundary Value Problems	
2.1	Classification of Second Order linear partial differential equations	1
2.2	Separation of variable method	1
	Tutorial	1
2.3	Hyperbolic equation- Wave equation, Solution by Fourier Series	2
2.4	Tutorial	2
2.5	Parabolic equation-Introduction to one dimensional heat equation	1
2.6	Elliptic equation-Laplace equation in two dimensional heat equation in Cartesian Co-ordinates and Polar Co-ordinates, Solution by Fourier Series	3
2.7	Tutorial	2
2.8	Introduction to Poisson equation	1
2.9	Tutorial	2
3	Vector Space and Subspaces	
3.1	Introduction to Vector space and subspace	2
3.2	Tutorial	1
3.3	Linear Independent and dependent	1
	Tutorial	1
3.4	Spanning set	1
3.5	Tutorial	1
3.6	Basis and dimension	1
	Tutorial	1
3.7	Row space and column space	1
	Tutorial	1
4	Orthogonality and Linear Transformation	
4.1	Introduction to orthogonality	1
4.2	Least Square approximation	2
4.3	Tutorial	2
4.4	Orthogonal basis and Gram Schmith orthogonalization	2
	Tutorial	1
4.5	Linear transformation and its matrix Representation	1
4.6	Tutorial	1
	Total	48



Course Designers:

1	Dr.M.Mutharasan	mmmat@tce.edu
2	Mrs.K.Angaleeswari	kangaleeswari@tce.edu
3	Dr.S.P.Suriya Prabha	suriyaprabha@tce.edu



14EC320	PROBLEM SOLVING USING COMPUTERS	Category	L	T	P	Credit
		ES	3	0	0	3

Preamble

This course is designed to introduce basic problem solving and program design skills that are used to create computer programs. It gives engineering students an introduction to programming and developing analytical skills to use in their subsequent course work and professional development. This course focuses on problem solving, algorithm development, top-down design, modular programming, debugging and testing using the programming constructs like flow-control, looping, iteration and recursion. It presents several techniques using computers to solve problems, including the use of program design strategies and tools, common algorithms used in computer program and elementary programming techniques.

Prerequisite

NIL

Course Outcomes

On the successful completion of the course, students will be able to

CO1	Comprehend the role of computing and use of programming concepts in developing engineering solutions.	Understand
CO2	Develop algorithms to solve fundamental mathematical problems, merging, sorting and searching.	Apply
CO3	Develop algorithms for text processing and pattern searching	Apply
CO4	Analyze a problem, identify the data in the problem, divide a problem into parts, solve individual parts using proper control structures and compose into an overall solution	Analyze
CO5	Design algorithmic solutions to problems drawn from engineering contexts and implement using any structured programming language	Apply

Mapping with Programme Outcomes

COs	PO 1	PO 2	PO 3	PO 4	PO 5	PO 6	PO 7	PO 8	PO 9	PO 10	PO 11	PO 12	PSO 1	PSO 2	PSO 3
CO1	M	-	-	-	-	-	-	-	L	M	-	L	L	-	-
CO2	S	M	L	-	S	-	-	M	S	M	-	M	M	L	M
CO3	S	M	L	-	S	-	-	M	S	M	-	M	M	L	M
CO4	S	S	M	-	S	-	-	M	S	M	-	M	S	L	L
CO5	S	M	L	-	S	-	-	M	S	M	-	M	M	L	M

S- Strong; M-Medium; L-Low

Assessment Pattern

	Bloom's category	Continuous Assessment Tests			End Semester Examinations
		1	2	3	
1	Remember	20	20	0	0
2	Understand	20	20	20	20
3	Apply	60	60	60	60
4	Analyze	0	0	20	20
5	Evaluate	0	0	0	0
6	Create	0	0	0	0

Course Level Assessment Questions**Course Outcome 1 (CO1):**

1. List the steps involved in problem solving.
2. State a reason why each of the six problem-solving steps is important in developing best solution for a problem.
3. What is an algorithmic solution to a problem?
4. What is a heuristic solution to a problem?

Course Outcome 2 (CO2):

1. Develop an algorithm and draw the flowchart for finding the factorial of a number.
2. Develop an algorithm that reads a list of numbers and makes a count of positive and negative numbers and count of zeros.
3. Design an algorithm to compute sum of the squares of the list of numbers.
4. Design an algorithm that arranges the given list of numbers using selection sorting.

Course Outcome 3 (CO3):

1. Design an algorithm that removes multiples blank spaces in a line of text.
2. Design an algorithm that left justifies a given paragraph.
3. Design and implement an algorithm to print all words in a given lines of text that starts with a search prefix.
4. Design and implement an algorithm that removes a particular pattern from a given text.

Course Outcome 4 (CO4):

1. Describe the problem inputs and outputs and write the algorithm for a program that computes an employee's gross salary given the hours worked and the hourly rate.
2. Write a recursive function to find the factorial of a number.
3. Write a function for finding the power of a number using recursion and without using recursion. Analyze its performance
4. An instructor calculates the grade percentage based on the highest score on a test. Given the highest score and one student's score, write a solution to calculate and print that student's test percentage.

Course Outcome 5 (CO5):

1. Write a program that takes the length and width of a rectangular yard and the length and width of a rectangular house situated in the yard. Your program should compute the time required to cut the grass at the rate of two square feet a second.
2. The Pythagorean theorem states that the sum of the squares of the sides of a right triangle is equal to the square of the hypotenuse. Given two positive integers, m and n , where $m > n$, display the values of the Pythagorean triple generated. a Pythagorean triple can be generated by the following formulas: $side_1 = m^2 - n^2$, $side_2 = 2mn$, $hypotenuse = m^2 + n^2$
3. Write a program to take a depth (in kilometers) inside the earth as input data; compute and display the temperature at this depth in degrees Celsius and degrees Fahrenheit. The relevant formulas are $Celsius = 10 (depth) + 20$ (Celsius temperature at depth in km) $Fahrenheit = 1.8 (Celsius) + 32$. Include two functions in your program. Function $celsius_at_depth()$ should compute and return the Celsius temperature at a depth measured in kilometers. Function $Fahrenheit()$ should convert a Celsius temperature to Fahrenheit.
4. A manufacturer would like to have a device for a car that will turn on a light when the temperature is between 34 and 40 degrees Fahrenheit (F) and sound a warning signal when the outside temperature is 34 degrees F or below. The light and the sound are never going simultaneously. Write a solution to this problem.

Concept Map

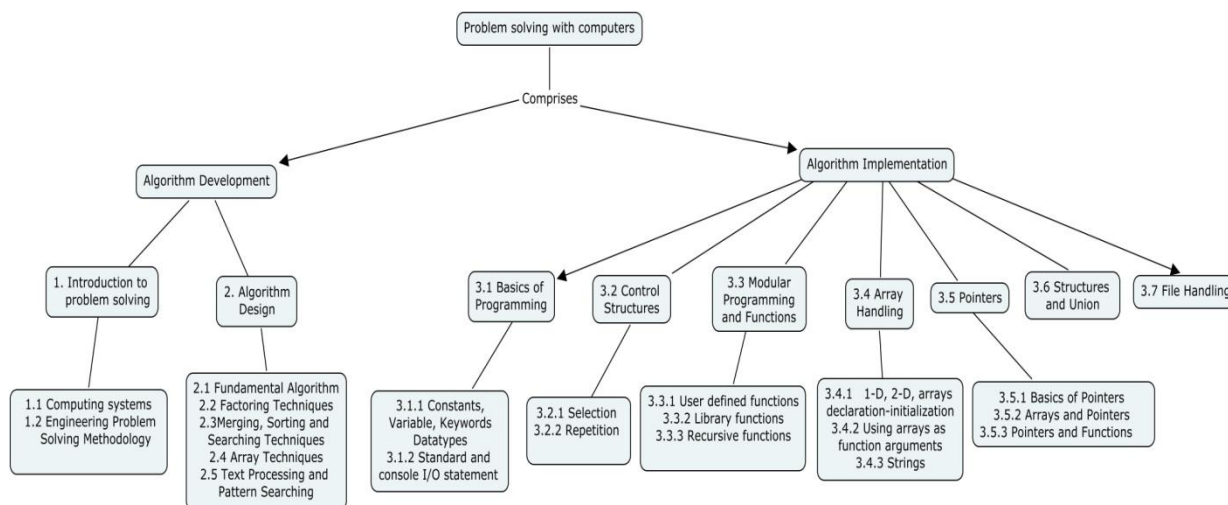

Syllabus

Introduction to problem solving with computers - Computing Systems: Hardware and Software – **Engineering Problem Solving Methodology:** problem specification and analysis, algorithm design, flowchart, implementation, program testing and verification

Algorithm Design: Fundamental algorithms: Swapping of two variables – counting – summation of set of numbers – factorial – Fibonacci sequence – base conversion **Factoring Techniques:** smallest divisor of an integer – greatest common divisor – generating prime number – generating prime factor **Merging, Sorting and searching Techniques:** Two way merge – sorting by selection sort – sorting by exchange – sorting by insertion – linear search – binary search **Array techniques:** Array order reversal – Statistical measurement - array counting - array Partitioning **Text Processing and Pattern Searching:** Key word search – text line editing –linear pattern search

Programming Concepts : **Basics of programming** -Constant, variable, keywords, data types - Operators, operator precedence, expressions - **Control Structures:** Selection structure- Repetition Structure **Modular Programming and Functions:** User defined functions- Recursive functions **Array Handling:** 1-D, 2-D: declaration – initialization, Using arrays as function arguments- Strings **Pointers:** Basics of Pointers - Arrays and Pointers - Pointers and Functions - **Structures and Union - File Handling.**

Text Book:

1. R G Dromey, "How To Solve It By Computer", Pearson Education India, 2008.

Reference Books:

1. Maureen Sprankle, Jim Hubbard, "Problem Solving & Programming Concepts", Prentice Hall, 2012
2. Jeri R. Hanly - Elliot B. Koffman, "Problem Solving and Program Design in C", 7th Edition, Pearson, 2013
3. Delores M. Etter, "Engineering Problem Solving with C", Pearson, 4th Edition, 2013.
4. Donald E. Knuth, "Art of Computer Programming", Pearson Education, 2012.
5. Yashavant Kanetkar, "Let us C", 8th Edition, BPB Publications, 2007

Course Contents and Lecture Schedule

Module No	Topics	No. of Lectures
1	Introduction to problem solving with computers	
1.1	Computing Systems: Hardware and Software	1
1.2	Engineering Problem Solving Methodology: problem specification and analysis, algorithm design, flowchart, implementation, program testing and verification	2
2	Algorithm Design	
2.1	Fundamental algorithms: Swapping of two variables – counting – summation of set of numbers – factorial – Fibonacci sequence – base conversion	2
2.2	Factoring Techniques: smallest divisor of an integer – greatest common divisor – generating prime number – generating prime factor	3
2.3	Merging, Sorting and searching Techniques: Two way merge – sorting by selection sort – sorting by exchange – sorting by insertion – linear search – binary search	3
2.4	Array techniques: Array order reversal – Statistical measurement - array counting - array Partitioning	3
2.5	Text Processing and Pattern Searching: Key word search – text line editing –linear pattern search	3
3	Programming Concepts :	
3.1	Basics of programming	
3.1.1	Constant, variable, keywords, data types	1
3.1.2	Standard and console I/O statement	1
3.1.3	Operators, operator precedence, expressions	1
3.2	Control Structures	
3.2.1	Selection structure	2
3.2.2	Repetition Structure	1
3.3	Modular Programming and Functions	
3.3.1	User defined functions	1
3.3.2	Library functions	1
3.3.3	Recursive functions	1
3.4	Array Handling	
3.4.1	1-D, 2-D arrays: declaration – initialization	1
3.4.2	Using arrays as function arguments	1
3.4.3	Strings	1
3.5	Pointers	
3.5.1	Basics of Pointers	1
3.5.2	Arrays and Pointers	1
3.5.3	Pointers and Functions	1

3.6	Structures and Union	2
3.7	File Handling	2
	Total	36

Course Designers:

1. Dr. R. A. Alaguraja alaguraja@tce.edu
2. Dr. S. Ponmalar spmece@tce.edu



14EC330	ELECTRONIC CIRCUIT DESIGN	Category	L	T	P	Credit
		PC	3	0	0	3

Preamble

Having attained the basic knowledge about the principle of operation of semiconductor electronic devices like diodes, transistors and elementary circuits in the second semester, this course will enable the students to learn about the use of transistors in analog circuits like single and multi stage amplifier, feedback amplifier, Differential amplifier, power amplifier and oscillators. It also gives information about the current mirror circuits used for biasing in Integrated Circuits and their applications in the field of electronics industry.

Prerequisite

Nil

Course Outcomes

On the successful completion of the course, students will be able to

CO1. Determine Input resistance, Output resistance, Voltage gain, and Current gain of the Single stage amplifiers and Multistage Amplifiers	Create
CO2. Derive the expression for Q point, CMRR of differential amplifier.	Analyze
CO3. Derive the expressions for voltage gain, input impedance of voltage series, voltage shunt, current series and current shunt negative feedback amplifiers.	Understand
CO4. Derive the frequency of oscillation and condition of Oscillation of RC and LC Oscillators.	Apply
CO5. Derive the equation for power output and conversion efficiency of Class A, Class B and Class C of large signal amplifiers	Understand
CO6. Deduce the equation for 3 dB bandwidth of single tuned and double tuned amplifier.	Apply

Assessment Pattern

Bloom's Category	Continuous Assessment Tests			Terminal Examination
	1	2	3	
Remember	20	10	20	10
Understand	30	30	40	30
Apply	30	30	20	20
Analyse	20	20	10	20
Evaluate	0	0	0	0
Create	0	10	10	20

Mapping with Programme Outcomes

COs	PO 1	PO 2	PO 3	PO 4	PO 5	PO 6	PO 7	PO 8	PO 9	PO 10	PO 11	PO 12	PSO 1	PSO 2	PSO 3
CO1	S	M	L	-	M	-	-	M	M	-	-	L	S	-	L
CO2	S	S	M	L	M	-	-	M	M	-	-	L	S	-	L
CO3	S	S	M	L	M	-	-	M	M	-	-	L	S	-	L
CO4	S	M	L	-	M	-	-	M	M	-	-	L	S	-	L
CO5	S	S	M	L	M	-	-	M	M	-	-	L	S	-	L
CO6	S	S	M	L	M	-	-	M	M	-	-	L	S	-	L

S- Strong; M-Medium; L-Low

Course Level Assessment Questions

Course Outcome 1 (CO1):

- Using two transistors Q1 and Q2 having equal lengths but widths related by $W_2/W_1 = 5$. Design a MOSFET current source to obtain $I_D = 0.5\text{mA}$. Let $V_{DD} = -V_{SS} = 5\text{V}$, $K_n'(W/L) = 0.8\text{mA/V}^2$, $V_t = 1\text{V}$.
- Design a common emitter amplifier with emitter degenerative resistance to operate between a $10\text{K}\ \Omega$ source and a $2\text{K}\ \Omega$ load with a gain of $-8\ \text{V/V}$. the power supply available is 9V . Use an emitter current of $2\ \text{mA}$ and a current of about one-tenth of that in the voltage divider that feeds the base, with the dc voltage at the base about one-third of the supply. The transistor $\beta = 100$.
- Design an audio amplifier (common emitter circuit) with an voltage gain of 10. The circuit uses a $12\ \text{V}$ power supply. The input impedance of the amplifier should be about 15K , the same as the potentiometer from which the audio was taken. The impedance of the stereo amplifier's auxiliary input is about 50K .

Course Outcome 2 (CO2):

- Consider 2-stage RC coupled amplifier shown in fig.2. What is the biasing potential for the second stage? If the coupling capacitor C_C is replaced by a wire, what would happen to the circuit?

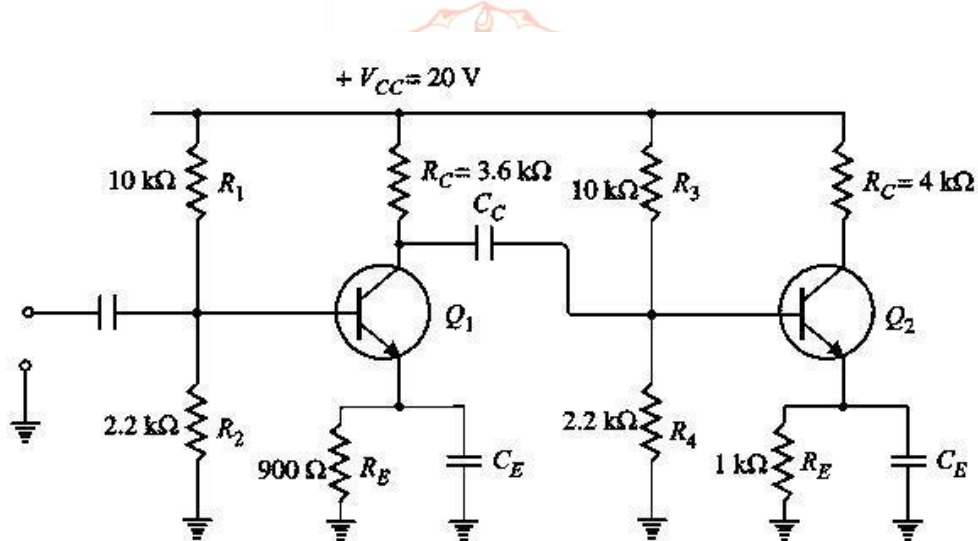
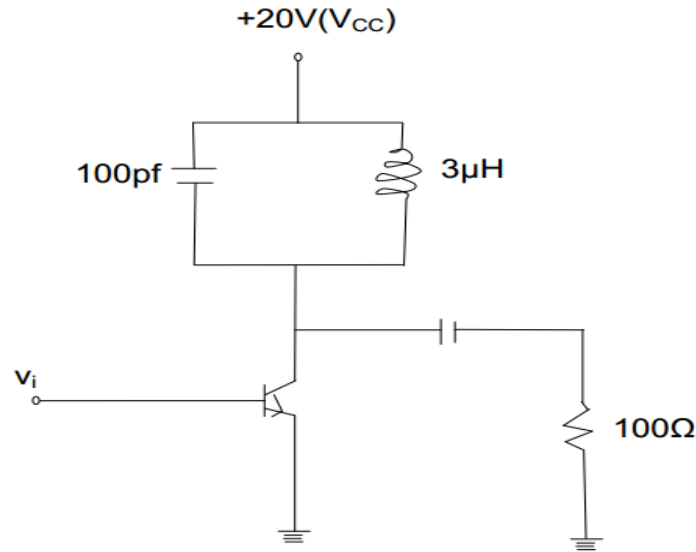

Fig 1

- Consider the circuit below with $\mu_n C_{ox} = 90\ \mu\text{A/V}^2$, $\mu_p C_{ox} = 30\ \mu\text{A/V}^2$, $V_{tn} = -V_{pn} = 0.7\text{V}$ and $V_{An} = -V_{Ap} = 20\ \text{V}$. The circuit is to operate such that all transistors operate at $V_{OV} = 0.5\ \text{V}$, $I_{D1} = I_{D2} = I_{D3} = I_{D4} = I_{ref} = 0.2\ \text{mA}$, and $\left(\frac{W}{L}\right)_5 = \left(\frac{W}{L}\right)_6$
 - Design the circuit (i.e., find (W/L) of all transistors).
 - Find the differential gain.
 - Find the common mode response at V_{o1} (i.e., V_{o1}/V_{CM}).
 - Find the input common-mode range
 - Find the allowable range of the output voltage.
 Ignore channel-length modulation in biasing calculations.

3. In fig. a basic Class C-amplifier is shown. It uses supply voltage of + 20V and load resistance of 100Ω. The operating frequency is 3MHz and $V_{CE(sat)} = 0.3$ V. Calculate the efficiency. If peak current is 500mA, find the conduction angle also.



4. Obtain the value of L in the circuit of single tuned amplifier shown in below. The circuit resonates at 10 MHz. Obtain the bandwidth and the current gain of the amplifier for $f_r = 500$ MHz.

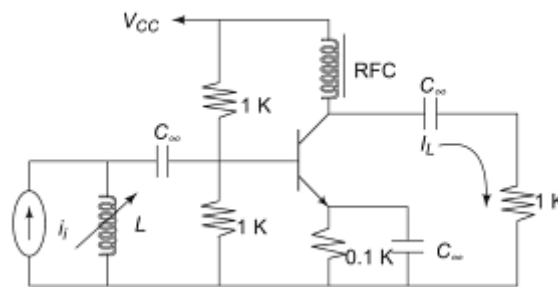

Course Outcome 5 (CO5):

1. Explain Class B push-pull Amplifier with Circuit diagram?
2. With the help of neat diagram, explain the characteristics of class-A amplifier?
3. Discuss about the output stages used in class AB amplifier and the advantage of using Darlington configuration.
4. Define cross over distortion.
5. Classify the output stages of power amplifiers with respect to the transistor conduction angle.

Concept Map

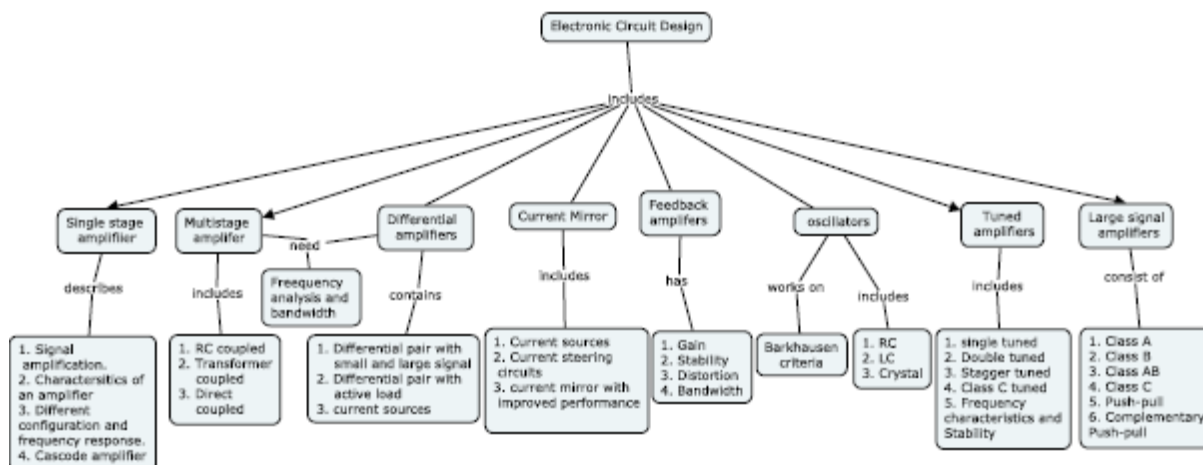

Syllabus

SINGLE STAGE AND MULTISTAGE AMPLIFIERS – Transistor amplification action – characteristics of amplifiers – Different configurations and their frequency response – Cascode amplifiers - Need for multistage amplifier - Gain of multistage amplifier - Different types of multistage amplifier - RC coupled, transformer coupled, direct coupled, and their frequency response and bandwidth.

CURRENT MIRRORS AND DIFFERENTIAL AMPLIFIERS - Current sources for biasing – Current steering circuits – Current mirror with improved performance (Cascode mirror, Wilson, Widlar). Large and small signal operation of Differential pair circuit – Differential pair with active load - Frequency response of the Differential amplifier.

FEEDBACK AMPLIFIERS AND OSCILLATORS - Basic principles and types of feedback - Gain of an amplifier employing feedback - Effect of feedback (negative) on gain, stability, distortion and bandwidth of an amplifier. Use of positive feedback - Barkhausen criterion for oscillations - Different oscillator circuits - tuned collector, Hartley Colpitts, phase shift, Wien's bridge, and crystal oscillator.

TUNED AMPLIFIERS - Series and parallel resonant circuits and bandwidth of resonant circuits - Single and double tuned voltage amplifiers and their frequency response Characteristics - Stagger tuned amplifiers – large signal tuned amplifiers – Class C tuned amplifier – Efficiency and applications of Class C tuned amplifier – Stability of tuned amplifiers

LARGE SIGNAL AMPLIFIER - Difference between voltage and power amplifiers - Importance of impedance matching in amplifiers - Class A, Class B, Class AB, and Class C amplifiers - Single ended power amplifiers, push-pull amplifier, and complementary symmetry push-pull amplifier

Text Book

1. Adel S. Sedra and Kenneth C. Smith, "Microelectronic Circuits", Oxford University Press, Sixth Edition, 2009.

Reference Books

1. Behzad Razavi, "Fundamentals of Microelectronics ", 1st edition, wiley publication, 2008.
2. Millman & Halkias, "Integrated Electronics", 48th reprint, Tata McGraw Hill, 2008.

Course Contents and Lecture Schedule

Module No.	Topic	No.of Lectures
1	SINGLE STAGE AND MULTISTAGE AMPLIFIERS	
1.1	Transistor amplification action and Characteristics of amplifiers	1
1.2	Different configurations and their frequency response	2
1.3	Cascode amplifiers	1
1.4	Need for multistage amplifier and Gain of multistage amplifier	1
1.5	Different types of multistage amplifier - RC coupled, transformer coupled, direct coupled.	2
1.6	Frequency response and bandwidth	1
2	CURRENT MIRRORS AND DIFFERENTIAL AMPLIFIERS	
2.1	Current sources for biasing and Current steering circuits	1
2.2	Current mirror with improved performance (Cascode mirror, Wilson, Widlar).	2
2.3	Large and small signal operation of Differential pair circuit	1
2.4	Differential pair with active load	1
2.5	Frequency response of the Differential amplifier.	1
3	FEEDBACK AMPLIFIERS AND OSCILLATORS	
3.1	Basic principles and types of feedback	1
3.2	Gain of an amplifier employing feedback	1
3.3	Effect of feedback (negative) on gain, stability, distortion and bandwidth of an amplifier	1
3.4	Use of positive feedback - Barkhausen criterion for oscillations	1
3.5	Different oscillator circuits - tuned collector, Hartley Colpitts, phase shift, Wien's bridge, and crystal oscillator	2
4	TUNED AMPLIFIERS	
4.1	Series and parallel resonant circuits and bandwidth of resonant circuits	1
4.2	Single and double tuned voltage amplifiers and their frequency response Characteristics	2
4.3	Stagger tuned amplifiers	1
4.4	large signal tuned amplifiers	1
4.5	Class C tuned amplifier – Efficiency and applications	2
4.6	Stability of tuned amplifiers	1
5	LARGE SIGNAL AMPLIFIER	
5.1	Difference between voltage and power amplifiers	1
5.2	Importance of impedance matching in amplifiers	1
5.3	Class A, Class B, Class AB, and Class C amplifiers	2
5.4	Single ended power amplifiers, push-pull amplifier,	2
5.5	Complementary symmetry push-pull amplifier	2
	Total	36

Course Designers:

1. Dr. S. Rajaram rajaram_siva@tce.edu
2. Mr. V. Vinoth Thyagarajan vvkece@tce.edu

14EC340	SIGNALS AND SYSTEMS	Category	L	T	P	Credit
		PC	2	1	0	3

Preamble

Signals and Systems arise in a wide variety of fields, and the ideas and techniques associated with these concepts play an important role in areas of science and technology as communications, aeronautics and astronautics, acoustics, seismology, biomedical engineering and speech processing. Signals are functions of one or more independent variables, contain information about the behaviour or nature of some phenomenon. Signals vary continuously in time or it is described only at discrete points in time. Systems respond to particular signals by producing other signals or some desired behaviour. Systems that respond to or process these signals leads naturally to two parallel frameworks for signal and system analysis, one for phenomena and processes that are described in continuous in time and one for those that are described in discrete in time. It introduces the students to analyze signals and systems and to design systems to enhance or restore signals that have been degraded in some way.

Prerequisite

Nil

Course Outcomes

On the successful completion of the course, students will be able to

CO1. Represent basic continuous time and discrete time signals and systems.	Understand
CO2. Explain signal properties such as periodicity, even or odd, energy or power and system properties such as causality, linearity and time-invariance	Understand
CO3. Find the response of an LTI System for a given continuous time or discrete time input signal	Apply
CO4. Determine the frequency response of periodic and aperiodic continuous time signals and discrete time signals	Apply
CO5. Convert a continuous time signal into discrete time signal and reconstruct the continuous time signal.	Apply
CO6. Analyze and characterize LTI system using z-Transforms	Analyze

Mapping with Programme Outcomes

COs	PO 1	PO 2	PO 3	PO 4	PO 5	PO 6	PO 7	PO 8	PO 9	PO 10	PO 11	PO 12	PSO 1	PSO 2	PSO 3
CO1	M	L	-	-	-	-	-	-	L	L	-	-	M	L	L
CO2	M	L	-	-	-	-	-	-	L	L	-	-	M	L	L
CO3	S	M	L	-	S	-	-	-	L	L	-	L	S	S	L
CO4	S	M	L	-	-	-	-	-	L	L	-	L	S	S	L
CO5	M	L	-	-	-	-	-	-	L	L	-	L	M	L	L
CO6	S	S	M	L	-	-	-	-	L	L	-	L	S	S	L

S- Strong; M-Medium; L-Low

Assessment Pattern

Bloom's Category	Continuous Assessment Tests			Terminal Examination
	1	2	3	
Remember	20	0	0	0
Understand	20	20	20	20
Apply	60	60	60	60
Analyse	0	20	20	20
Evaluate	0	0	0	0
Create	0	0	0	

Course Level Assessment Questions

Course Outcome 1 (CO1):

1. Show that any signal can be decomposed in to an even and odd component. Is the decomposition unique? Illustrate your arguments using the signal $x[n] = e^{j\omega n}$
2. Show that $\delta(n) = u(n) - u(n-1)$
3. A discrete time signal $x(n)$ is shown in figure. Sketch and label carefully each of the following signals.

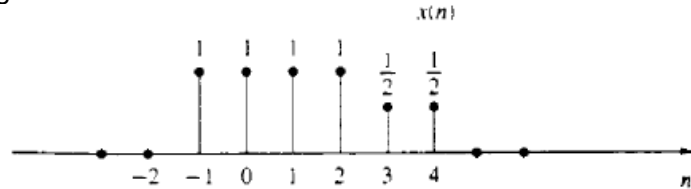

- a. $x(2-n)$
 - b. $x(n)u(2-n)$
 - c. $x(n^2)$
 - d. even part of $x(n)$
 - e. $x(n-1)\delta(n-3)$
4. Sketch the signal $e^{-10t}u(t)$ and calculate the energy.

Course Outcome 2 (CO2):

1. For the each of the following systems, determine whether or not the system is 1. Linear and 2. Time invariant
 - a. $y(n) = x(n)\cos(0.2\pi n)$
 - b. $y(n) = Ax(n) + B$, where A and B are constants.
2. Determine whether or not each of the following continuous time signals is periodic. If the signal is periodic, determine its fundamental period.
 - a. $x(t) = 3\cos\left(4t + \frac{\pi}{3}\right)$
 - b. $x(t) = e^{j(\pi t - 1)}$
3. For each of the following input-output relationships, determine whether the corresponding system is linear, time invariant or both.
 - a. $y(t) = t^2x(t-1)$
 - b. $y(n) = x(n+1) - x(n-1)$

Course Outcome 3 (CO3):

1. Consider the interconnection of LTI systems as shown in figure

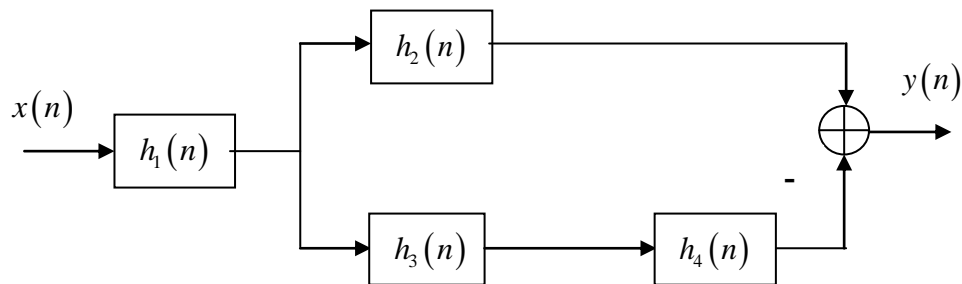

- a. Express the overall impulse response in terms of $h_1(n)$, $h_2(n)$, $h_3(n)$ and $h_4(n)$.

- b. Determine $h(n)$ when $h_1(n) = \{1/2, 1/4, 1/2\}$,
 $h_2(n) = h_3(n) = \delta(n) + 2\delta(n-2) + \delta(n-4)$ and $h_4(n) = \delta(n-2)$. Determine
the response of the system in part (b) if $x(n) = \delta(n) + 3\delta(n-3) - 4\delta(n-5)$

2. Let $x(t) = u(t-3) - u(t-5)$ and $h(t) = e^{-3t}u(t)$.

a. Compute $y(t) = x(t) * h(t)$

b. Compute $g(t) = \left(\frac{dx(t)}{dt}\right) * h(t)$

c. How is $g(t)$ is related to $y(t)$?

3. Let $x(n) = \delta(n) + 2\delta(n-1) - \delta(n-3)$ and $h(n) = 2\delta(n+1) + 2\delta(n-1)$. Compute and plot each of the following convolutions:

a. $y_1(n) = x(n) * h(n)$

b. $y_2(n) = x(n+2) * h(n)$

c. $y_3(n) = x(n) * h(n+2)$

Course Outcome 4 (CO4):

1. A periodic signal $x(t)$ is given by $x(t) = 1 + 2\cos\left(300\pi t + \frac{\pi}{4}\right) + \sin(500\pi t)$

a. What is the period of $x(t)$?

b. Find the Fourier series coefficient of $x(t)$ for $-6 \leq k \leq 6$.

2. Consider the square wave with 50 % duty cycle. Compute the exponential Fourier series and draw the spectrum for the square wave for 50 % duty cycle, having frequency of 25 Hz; then Synthesize the square wave from the Fourier coefficients for different harmonics and Describe Gibbs phenomenon

3. A periodic signal is represented by the Fourier Synthesis formula: $x(t) = \sum_{k=-\infty}^{\infty} a_k e^{j30\pi kt}$

$$\text{where } a_k = \begin{cases} \frac{1}{4 + j2k} & k = -3, -2, -1, 0, 1, 2, 3 \\ 0 & |k| > 3 \end{cases}$$

a. Sketch the two sided spectrum of the signal. Label all complex amplitudes in polar form.

b. Determine the fundamental frequency and fundamental period of the signal.

4. Consider a causal LTI system with frequency response $H(j\omega) = \frac{1}{j\omega + 2}$. For a particular input $x(t)$, this system is observed to produce the output $y(t) = e^{-2t}u(t) - e^{-3t}u(t)$. Determine $x(t)$

Course Outcome 5 (CO5):

1. Consider the analog signal $x_a(t) = 3\cos(2000\pi t) + 5\sin(6000\pi t) + 10\cos(12000\pi t)$
 - a. What is the Nyquist rate for this signal?
 - b. Assume now that we sample this signal using a sampling rate $F_s = 5000$ samples/sec. What is the discrete time signal obtained after sampling?
 - c. What is the analog signal $y_a(t)$ we can reconstruct from the samples if we use ideal interpolation?
2. The frequency which, under the sampling theorem, must be exceeded by the sampling frequency is called the Nyquist rate. Determine the Nyquist rate corresponding to each of the following signals:
 - a. $x(t) = 1 + \cos(2000\pi t) + \sin(4000\pi t)$
 - b. $x(t) = \frac{\sin(4000\pi t)}{\pi t}$
 - c. $x(t) = \left(\frac{\sin(4000\pi t)}{\pi t}\right)^2$
3. Show that $7\cos(8.4\pi n - 0.2\pi)$ is an alias of $7\cos(0.4\pi n - 0.2\pi)$

Course Outcome 6 (CO6):

1. An LTI system is described by the difference equation $y[n] = \frac{1}{4}[x[n] + x[n-1] + x[n-2] + x[n-3]]$.
 - a) What is $h[n]$, the impulse response of this system?
 - b) Determine the system function $H(z)$ for this system.
 - c) Plot the poles and zeros of $H(z)$ in the complex z -plane.
 - d) From $H(z)$, obtain an expression for the frequency response $H(e^{j\omega})$ of this system
2. Compute the convolution $x[n]$ of the signals

$$x_1[n] = \{1, -2, 1\}$$

$$x_2[n] = \begin{cases} 1, & 0 \leq n \leq 5 \\ 0, & \text{otherwise} \end{cases}$$
 using the property of z-transform.
3. Find the region of convergence of z-transform of the sequence $\left(\frac{5}{6}\right)^n u(n) - \left(\frac{6}{5}\right)^n u(-n-1)$?
4. The z-transform of a system is $H(z) = \frac{z}{z-0.2}$. If the ROC is $|z| < 0.2$, then the impulse response of the system is?

Concept Map

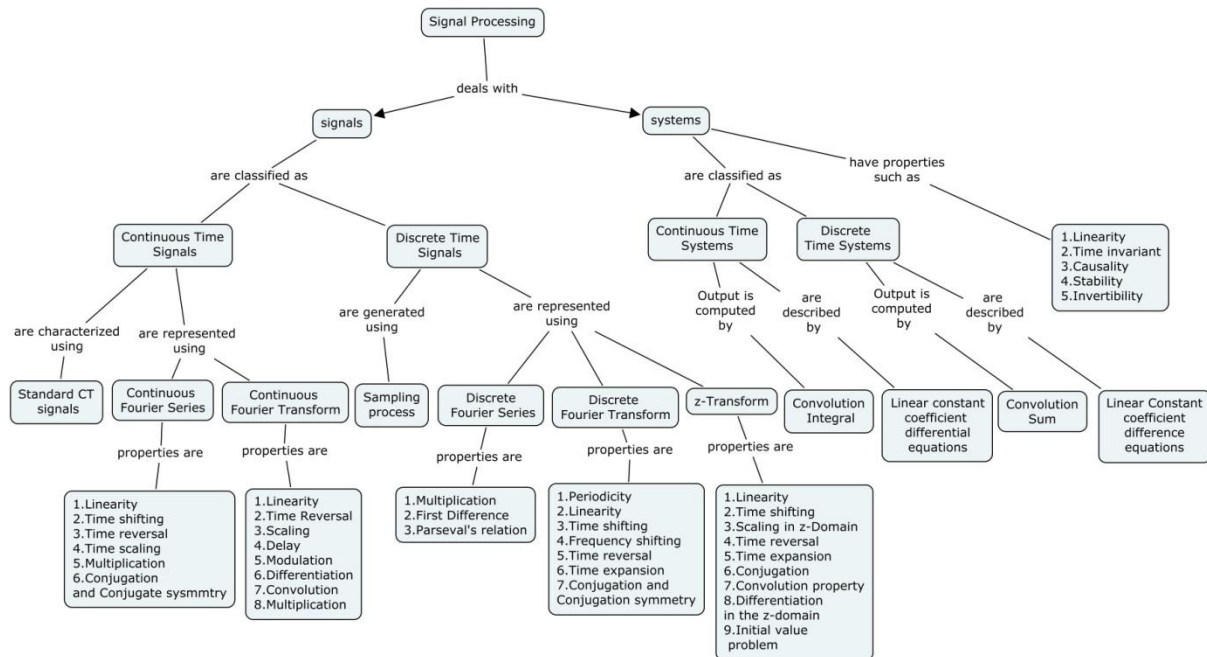

Syllabus

Introduction: Standard Signals: Unit impulse, unit step, unit ramp, exponential, and sinusoidal signals, Sampling Process, Mathematical Representation of Continuous and discrete time signals, Types of signals: power, energy, periodic, even and odd, **Basic System Properties: Linearity, Time Invariant, causality, stability and invertibility.**

Time Domain Characterisation of Continuous Time LTI system: Convolution Integral, Properties of continuous time LTI system, Causal continuous time LTI system described by differential equations.

Frequency Domain Representation in Continuous Time Signals: Fourier series representation of continuous time periodic signals, properties of continuous time Fourier series, Fourier transform of continuous time aperiodic signals and periodic signals, properties of continuous time Fourier transform.

Time Domain Characterisation of Discrete Time LTI system: Convolution sum, properties of discrete time LTI system, Causal discrete time LTI system described by difference equations.

Frequency Domain Representation in Discrete Time Signals: Fourier series representation of discrete time periodic signals, properties of discrete time Fourier series, Discrete time Fourier transform, properties.

z-Transform: z-Transform and linear systems, properties of z-Transform, Analysis and characterization of LTI system using z-Transform

Text Book

1. Alan V.Oppenheim, Alan S.Willsky and S.Hamid Nawab, "Signals & Systems", Prentice-Hall of India, Second Edition, 2011.

Reference Books

1. James H.McClellen, Ronald W.Schafer, Mark A.Yoder, "Signal Processing First", Pearson Education, 2003
2. Rodger E.Ziemer, William H.Tranter and D.Ronald Fannain "Signals & Systems Continuous and Discrete", Pearson Education, 2002.
3. Simon Haykin, Barry Van Veen, "Signals and Systems", Wiley, 2nd Edition, 2002.
4. Sophocles J.Orfanidis "Introduction to Signal Processing", Prentice Hall, 1996.

5. Ashok Ambardar, " Digital Signal Processing: A Modern Introduction", Nelson Engineering, 2007

Course Contents and Lecture Schedule

No.	Topic	No. of Lectures
1	Introduction	
1.1	Standard signals: Unit impulse, Unit step, Unit ramp, exponential and sinusoidal signals	1
1.2	Sampling process	2
1.3	Mathematical representation of continuous and discrete time signals	1
1.4	Types of signals: Power energy, periodic, even and odd	2
1.5	System properties: Linearity, time invariant, causality, stability and invertibility	2
1.6	Tutorial	2
2	Time Domain Characterisation of Continuous time LTI system	
2.1	Convolution Integral	1
2.2	Properties of continuous time LTI system	2
2.3	Causal continuous time LTI system described by differential equations	2
2.4	Tutorial	1
3	Frequency Domain representation in continuous time signal	
3.1	Fourier series representation of continuous time periodic signals	2
3.1	properties of continuous time Fourier series	2
3.2	Fourier transform of continuous time aperiodic signals	2
3.3	Fourier transform of continuous time periodic signals	2
3.4	properties of continuous time Fourier transform	2
3.5	Tutorial	1
4	Time Domain Characterisation of Discrete time LTI system	
4.1	Convolution sum	2
4.2	properties of discrete time LTI system	2
4.3	Casual discrete time LTI system described by difference equations	2
4.4	Tutorial r	1
5	Frequency Domain representation in discrete time signals	
5.1	Fourier series representation of discrete time periodic signals	2
5.2	properties of discrete time Fourier series	1
5.3	Discrete time Fourier transform	2
5.4	Properties	2
5.5	Tutorial	1
6	z-Transform	
6.1	z-Transform and linear systems	1
6.2	properties of z-Transform	2
6.3	Analysis and characterization of LTI system using z-Transform	2
6.4	Tutorial	1
	Total	48

Course Designers:

1	Dr.S.J.Thiruvengadam	sitece@tce.edu
2.	Mr.P.G.S.Velmurugan	pgsvels@tce.edu

14EC350	ELECTROMAGNETICS	Category	L	T	P	Credit
		PC	2	1	0	3

Preamble

The purpose of this course is to provide a conceptual understanding of fundamentals of electrostatics, magnetostatics, and electromagnetics, with an emphasis on wave propagation. This course also emphasizes the physical understanding and practical applications of electromagnetics in electronics and bio medical systems.

Prerequisite

Nil

Course Outcomes

On the successful completion of the course, students will be able to

CO1. Apply the concepts of electric and magnetic fields to practical engineering problems	Apply
CO2. Apply elementary solution techniques for electrostatics and magnetostatics equations.	Apply
CO3. Interpret Maxwell's equations for time dependent electromagnetic fields.	Understand
CO4. Determine parameters such as frequency, phase constant, velocity, skin depth and associated intrinsic impedance for different media.	Apply
CO5. Distinguish among linear polarization, circular polarization, and elliptical polarization, with right-hand/left-hand orientation.	Analyze
CO6. Calculate reflection and transmission coefficients and fields for uniform plane waves normally- incident and obliquely- incident on planar interfaces.	Analyze

Mapping with Programme Outcomes

COs	PO 1	PO 2	PO 3	PO 4	PO 5	PO 6	PO 7	PO 8	PO 9	PO 10	PO 11	PO 12	PSO 1	PSO 2	PSO 3
CO1	S	M	L	-	-	-	-	-	L	-	-	-	S	-	-
CO2	S	M	L	-	-	-	-	-	-	-	-	-	S	-	-
CO3	M	L	-	-	-	-	-	-	-	-	-	-	L	-	-
CO4	S	M	L	-	-	-	-	-	L	-	-	-	S	-	-
CO5	S	S	M	-	-	-	-	-	L	-	-	-	S	-	-
CO6	S	S	M	-	-	-	-	-	-	-	-	-	S	-	-

S- Strong; M-Medium; L-Low

Assessment Pattern

Bloom's Category	Continuous Assessment Tests			Terminal Examination
	1	2	3	
Remember	20	20	20	0
Understand	20	20	20	20
Apply	40	40	40	60
Analyze	20	20	20	20
Evaluate	0	0	0	0
Create	0	0	0	0

Course Level Assessment Questions

Course Outcome 1 (CO1):

1. Point charges 1mC and -2mC are located at (3,2,-1) and (-1,-1,4), respectively. Calculate the electric force on a 10 nC charge located at (0,3,1) and the electric field intensity at that point.
2. Florida phosphate ore consisting of small particles of quartz and phosphate rock. They can be separated into its components by applying a uniform electric field. Assuming initial velocity and displacement, determine the separation between the particles after falling 80cm. take $E = 500 \text{ KV/m}$ and $Q/m = 9 \mu\text{C/Kg}$ for both positively and negatively charged particles.
3. Let us select a 50 cm length of coaxial cable having an inner radius of 1 mm and an outer radius of 4mm. the space between conductors is assumed to be filled with air. The total charge on the inner conductor is 30nC. Find the charge density on each conductor, and the E and D fields.

Course Outcome 2 (CO2):

1. A volume charge is distributed throughout the sphere of radius a m, and centered at the origin, with uniform density $\rho_0 \text{ C/m}^3$. Find the energy stored in the electric field of this charge distribution.
2. Find an approximate value for the total charge enclosed in an incremental volume of 10^{-9}m^3 located at the origin, if $D = e^{-x} \sin ya_x - e^{-x} \cos ya_y + 2za_z \text{ C/m}^2$.
3. Assuming that the circular ring is coated with charge such that the charge density is given by $\rho_L = \rho_{L0} \cos\phi \text{ C/m}$, find the electric field intensity at a point on the z- axis by setting up the integral expression and evaluating it.

Course Outcome 3 (CO3):

1. Find the divergence of the following vector fields: (a) $3xa_x + (y-3)a_y + (2-z)a_z$
(b) $r^2 \sin\theta a_\theta$ in spherical co-ordinates
2. Show that the vector field given by $F = \cos\theta \sin\phi a_r - \sin\theta \sin\phi a_\theta + \cot\theta \cos\phi a_\phi$ is a conservative field. Then find the value of $\int F \cdot dl$ from the point $(1, \frac{\pi}{6}, \frac{\pi}{3})$ to the point $(4, \frac{\pi}{3}, \frac{\pi}{6})$
3. Let us consider charge distributed uniformly with density $\rho_{L0} \text{ C/m}$ along the z-axis and find the electric field due to the infinitely long line charge.

Course Outcome 4 (CO4):

1. A plane wave in a nonmagnetic medium has $E = 50 \sin(10^8 t + 2z) a_y \text{ V/m}$. Find (a) the direction of wave propagation, (b) λ , f, and ϵ_r (c) H
2. A uniform plane wave propagating in a medium has $E = 2e^{-\alpha z} \sin(10^8 t - \beta z) a_y \text{ V/m}$. If the medium is characterized by $\epsilon_r = 1$, $\mu_r = 20$ and $\sigma = 3 \text{ mhos/m}$, find α , β and H .
3. Let us consider the electric field of a uniform plane wave propagating in seawater ($\sigma = 4 \text{ S/m}$, $\epsilon = 80\epsilon_0$, and $\mu = \mu_0$) in the positive z- direction and having the electric field $E = 1 \cos 5 \times 10^4 \pi t a_x \text{ V/m}$ at $z = 0$. Find the instantaneous power flow per unit area

normal to the z-direction as a function of z and the time average power flow per unit area normal to the z-direction as a function of z.

Course Outcome 5 (CO5):

- Given $f(z, t) = 10\cos(3\pi \times 10^7 t + 0.1\pi z)$, draw sketches of f versus z for $t = 0, 10^{-7}/6$ s, and $10^{-7}/3$ s, on the same graph. Discuss the nature of the function.
- Two sinusoidally time-varying vector fields are given by $F_1 = F_0 \cos(2\pi \times 10^8 t - 2\pi z)\mathbf{a}_x$, $F_2 = \cos(2\pi \times 10^8 t - 3\pi z)\mathbf{a}_y$ find the polarization of F_1+F_2 at each of the following points (a) (3,4,0); (b)(3,-2,0.5); (c)(-2,1,1); and (d) (-1,-3,0.2).

Course Outcome 6 (CO6):

- In free space, $\mathbf{E}(z,t) = 10^3\sin(\omega t - \beta z)\mathbf{a}_y$ V/m. obtain $\mathbf{H}(z,t)$.
- A normally incident \mathbf{E} field has amplitude $E_o^i = 1.0$ V/m in free space just outside of seawater in which $\epsilon_r = 80$, $\mu_r = 1$, and $\sigma = 2.5$ S/m. For a frequency of 30MHz, at what depth will the amplitude of \mathbf{E} be 1.0 mV/m?
- Examine the field $\mathbf{E}(z,t) = 10\sin(\omega t + \beta z)\mathbf{a}_x + 10 \cos(\omega t + \beta z)\mathbf{a}_y$ V/m in the $z = 0$ plane, for $\omega t = 0, \pi/4, \pi/2, 3\pi/4$ and π .

Concept Map

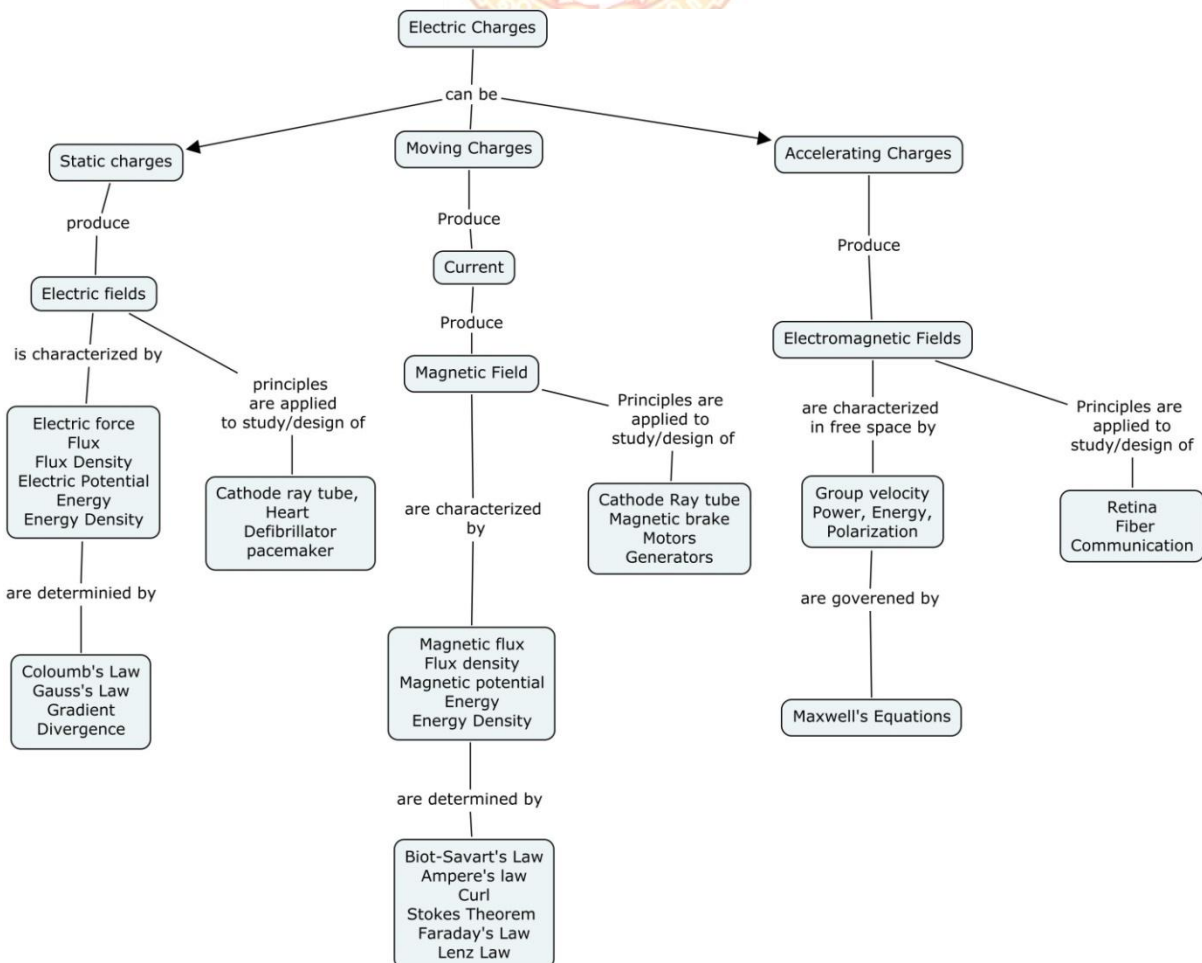

Syllabus

Introduction: Review of vector calculus, Coordinate systems.

Electrostatics: Electric charge, Coulomb's law, Electric field, Electric potential, Gradient, Charge densities – Line, Surface, Volume charge densities, Electric flux, Electric flux density, Gauss's law, Divergence, Laplace and Poisson's equations, Boundary conditions, Capacitance, Electric energy and energy density, Electric current, Current density, Point form of Ohm's law, Dielectric, Conductor, and Semiconductor- An overview, **Applications**- CRT-electric deflection, Heart dipole field, Defibrillators, Pacemakers, Cross talk.

Magnetostatics: Magnetic field, Biot-Savart's law, Ampere's law, magnetic flux, Magnetic flux density, Gauss's law, Magnetic vector potential, Lorentz force equation, Boundary conditions, Inductance and Inductors, Magnetic energy and energy density, **Applications** – CRT – magnetic deflection, Magnetic brake, Linear motor.

Time Varying Field: Induction, Faraday's law, Lenz's law, Curl, Displacement current, Limitations of Ampere's law, Maxwell's equations, **Applications** – Generator, Rotary motor.

Uniform Plane Wave: Circuit theory Vs Field theory, Wave, Wave equation, Wave propagation in space, Travelling waves and standing waves, Conducting media and Dielectric loss, Plane waves at interfaces, Normal incidence, Phase velocity, Group velocity, Index of refraction, Power and energy relations, Polarizations - Linear, Elliptic and Circular, Oblique incidence - reflection, and refraction for parallel and perpendicular cases, diffraction, **Applications** – Retinal optic fibres, Electromagnetic hazards and the environment.

Course Contents and Lecture Schedule

Module No.	Topic	No.of Lectures
1	Introduction:	1
1.1	Review of vector calculus, Coordinate systems,	2
	Tutorial	2
2	Electrostatics:	
2.1	Electric charge , Force , electric field	1
2.2	Electric Potential, Gradient, Charge densities- line, surface and volume	2
2.3	Electric Flux, flux density, Gauss's law	1
2.4	Divergence, Laplace and Poisson equations, boundary conditions	2
2.5	Capacitance and energy density	1
2.6	Electric current, current density, Ohm's law at a point	1
2.7	Dielectrics, semiconductors and conductors	1
2.8	Applications – CRT-Electric deflection, heart dipole field, Defibrillator, Pacemaker, cross talk	1
	Tutorial	3
3	Magnetostatics:	
3.1	Magnetic field, Biot-Savart's law, magnetic flux, magnetic flux density, Ampere's law,	2
3.2	Gauss's law, Magnetic vector potential, Lorentz force	2
3.3	Boundary conditions, Inductance, magnetic energy, energy density	2
3.4	Applications – CRT- magnetic deflection, magnetic brake, linear motor	1
	Tutorial	2
4	Time Varying Field:	
4.1	Induction, Faraday's law, Lenz law, curl	2
4.2	Displacement current, Limitations of Ampere's law, Maxwell's equations. Application – Generator.	3
	Tutorial	2

5	Uniform Plane Wave:	
5.1	Circuit theory Vs Field theory, Wave, Wave equation, Wave propagation in space, Travelling waves and standing waves	3
5.2	Conducting medias, Dielectric loss, plane waves at interfaces, Normal Incidence	3
5.3	Phase velocity, group velocity, index of refraction, Poynting theorem.	1
5.4	Polarization, Oblique incidence, reflection, refraction, diffraction	3
5.5	Applications- Retinal optic fibres, Electromagnetic hazards and the environment.	1
	Tutorial	3
	Total	48

Text Books:

1. John D Kraus and Daniel A Fleisch," Electromagnetics with applications", Fifth Edition, McGraw-Hill, 1999.

Reference Books:

1. Martin.K.Plonus, " Applied Electromagnetics", McGraw Hill, 1978
2. William H. Hayt, John A. Buck, "Engineering Electromagnetics", Sixth Edition, McGraw-Hill, 2001.
3. Matthew N.O. Sadiku, Principles of Electromagnetics, Fourth Edition, Oxford University Press, 2009.
4. N.N Rao, Elements of Engineering Electromagnetics, Prentice- Hall, 2004.
5. J. Edminister, Schaum's Outline of Electromagnetics, Second Edition, McGraw-Hill, 1993.

Course Designers:

1	Dr.V.Abhaikumar	principal@tce.edu
2.	Dr.A.Thenmozhi	thenmozhi@tce.edu

14EC370	MICROPROCESSOR ARCHITECTURE AND PROGRAMMING	Category	L	T	P	Credit
		PC	2	0	1	3

Preamble

The microprocessor has move out of giant air-conditioned rooms into closets, then onto desktops, and now into our laps and pockets. The rapid improvement in microprocessor architecture has come to both advances in the technology used to build computers and from innovation in computer design. The Engineering professionals should be familiar with the concepts of benchmarking in microprocessor and be able to interpret and present the results of benchmarking systems. People who perform design and research involving microprocessor hardware systems, networks, or algorithms find benchmarking techniques is crucial to their day-to-day work. The study of microprocessor architecture, on the other hand, focuses on the structure and behavior of the computer system and refers to the logical aspects of system implementation as seen by the engineer. The course on microprocessor includes elements such as instruction sets and formats, operation codes, data types, the number and types of registers, addressing modes, main memory access methods, and various I/O mechanisms of microprocessor. The architecture of a processor directly affects the logical execution in system. Studying this course helps us to answer the question: How do I design a computer?

Prerequisite

Nil

Course Outcomes

On the successful completion of the course, students will be able to

CO1. Distinguish between the functionalities of finite state machine and Microprocessor	Remember
CO2. Describe the functionality of each registers in a microprocessor	Understand
CO3. Illustrate the instructions set present in a processor for logical and arithmetic operations	Understand
CO4. Explain the x86 architecture and memory organization of the processor	Understand
CO5. Demonstrate programming proficiency using the various addressing modes and data transfer instructions of the target microprocessor	Apply
CO6. Illustrate the interrupts, stack in a microprocessor and demonstrate peripherals by writing appropriate program	Apply

Mapping with Programme Outcomes

COs	PO 1	PO 2	PO 3	PO 4	PO 5	PO 6	PO 7	PO 8	PO 9	PO 10	PO 11	PO 12	PSO 1	PSO 2	PSO 3
CO1	M	L	-	-	-	-	-	L	L	L	-	-	M	-	-
CO2	M	L	-	-	-	-	-	L	L	L	-	-	M	-	-
CO3	S	M	L	-	-	-	-	M	M	M	-	L	S	-	M
CO4	M	L	-	-	-	-	-	L	L	L	-	-	M	-	-
CO5	S	M	L	-	M	-	-	M	M	M	-	L	S	-	M
CO6	S	M	L	-	L	-	-	M	M	M	-	L	S	-	M

S- Strong; M-Medium; L-Low

Assessment Pattern

Bloom's Category	Continuous Assessment Tests			Terminal Examination
	1	2	3	
Remember	20	20	Practical	10
Understand	40	40		20
Apply	40	40		70
Analyse	0	0		0
Evaluate	0	0		0
Create	0	0		0

Course Level Assessment Questions**Course Outcome 1 (CO1):**

1. State the functionality of a finite state machine and the microprocessor.
2. List the microprocessors launched by various company.
3. Define the functionality of a microprocessor.
4. Distinguish between 8 bit and 16 bit microprocessors.

Course Outcome 2 (CO2)

1. State the functionality of Program counter in a microprocessor.
2. List the registers present in x86 microprocessors.
3. Define the functionality of a stack and stack pointer.
4. Show the operation of microprocessor when it access the stack.

Course Outcome 3(CO3):

1. Demonstrate the segment override instructions in x86.
2. Give example for accessing content in the data segment.
3. Describe the functionality of the branch instructions.
4. Distinguish between jump and call instructions.

Course Outcome 4 (CO4):

1. Demonstrate the memory segmentation for x86 architecture.
2. Give example for generating physical address for accessing data segment.
3. Describe the functionality of the pipeline mechanism in X86.
4. Distinguish between jump and call instructions.

Course Outcome 5 (CO5):

1. Illustrate the accessing of data segment by various addressing mode.
2. Show the program for accessing a stack segment in x86.
3. Demonstrate the operation of stack and stack pointer through push and pop Instructions.
4. Construct the program for interchanging a memory space from one segment to another segment.

Course Outcome 6 (CO6):

1. Illustrate that how to handle interrupts in x86 architecture.
2. Show the program for accessing a maskable interrupt in x86.
3. Demonstrate the operation of PPI -8252 with proper mapping diagram.
4. Construct the program for interfacing timer with x86 architecture.

Concept Map

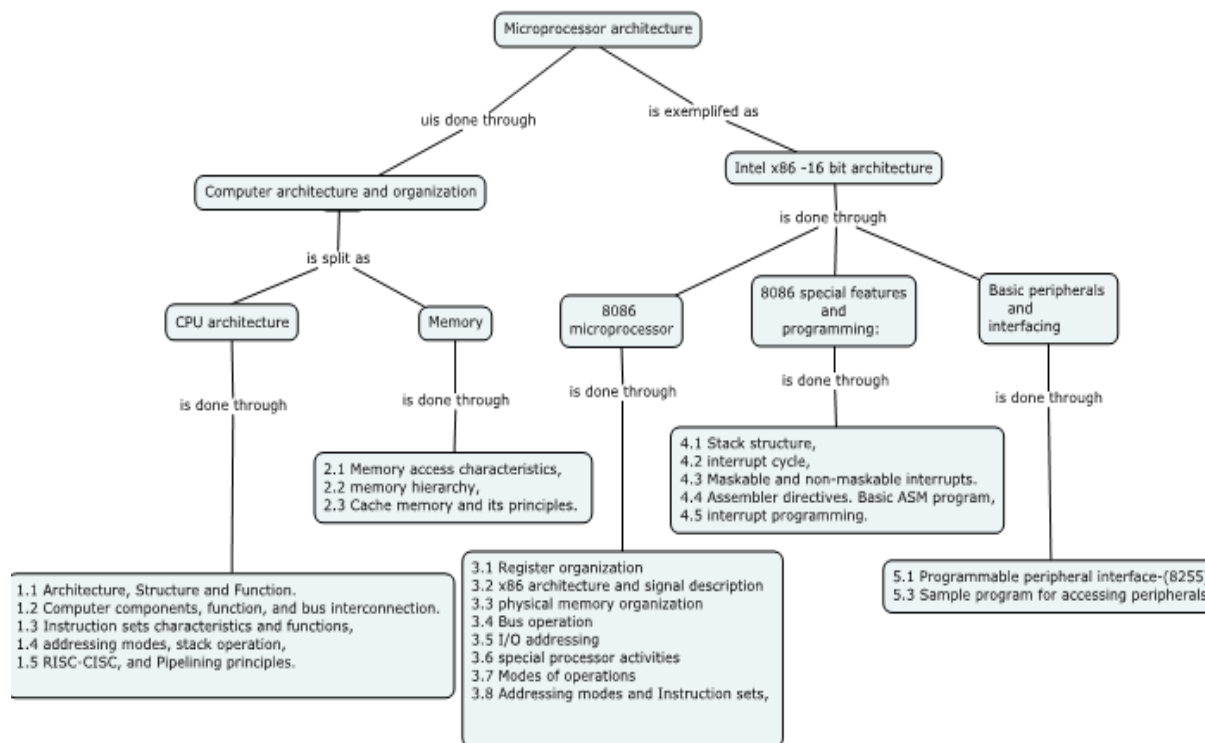

Syllabus

Theory:

Computer organization and architecture: Architecture, Structure and Function. Computer components, function, and bus interconnection. Instruction sets characteristics and functions, addressing modes, stack operation, RISC-CISC, and Pipelining principles.

Computer memory systems: Memory access characteristics, memory hierarchy, Cache memory and its principles.

8086 microprocessor: Register organization, x86 architecture and signal description, physical memory organization, Bus operation, I/O addressing, special processor activities, Modes of operations. Addressing modes, Instruction sets,

8086 special features and programming: Stack structure, interrupt cycle, Maskable and non-maskable interrupts. Assembler directives. Basic ASM program, interrupt programming.

Basic peripherals and interfacing: Programmable peripheral interface-(8255) and Programmable interval timer (8253). Sample program for accessing peripherals

Practical:

- **Development of ASM program and Implementation using either Intel 8085/ EMU8086 with MASM Tools or Coldfire Microprocessor**
 1. Arithmetic operation of single precision data
 2. Arithmetic operation of double and multi precision data
 3. Copying a string of data from one segment to other segment
 4. Sorting of 8 bit data, 16 bit data, and 32 bit data in an array
 5. Implementing quadratic equation in asm coding
 6. Interrupt handling
 7. Accessing peripherals
- Mini Project on ASM coding for simulation of an application like Game, System control or Monitoring a real time data using Intel 8085 kit with peripheral interface, EMU 8086, Coldfire microprocessor, MASM tool or any other custom made tool.

Text Books

1. William Stallings "Computer Organization and architecture designing for Performance", 8th Edition, Prentice Hall, 2013
2. K. Ray, K. M. Bhurchandi, "Advanced Microprocessors and Peripherals – Architecture, Programming and Interface", Tata McGraw Hill, 2013

Reference Books

1. David A. Patterson, John. L. Hennessey: Computer organization and design-the hardware/software Interface, Elsevier-Morgan Kaufmann Publishers-2014.
2. Gaonkar R. S.: Microprocessor Architecture: Programming and Applications with the 8085/8086A, New Age International (P) Ltd., 2010
3. Munir Bannoura, Rudan Bettelheim and Richard Soja, "ColdFire Microprocessors & Microcontrollers" –, AMT Publishing, 2005.

Course Contents and Lecture Schedule

Module No.	Topic	No. of Lectures
1	Computer Organization and Architecture	
1.1	Architecture, Structure and Function.	2
1.2	Computer. components, function	1
1.3	Bus interconnection	1
1.4	Instruction sets characteristics and functions, addressing modes	2
1.5	Stack operation, RISC-CISC, and Pipelining principles.	1
2	Computer Memory Systems	
2.1	Memory access characteristics, memory hierarchy	1
2.2	Cache memory and its principles	1
3	8086 microprocessor	
3.1	Register organization	1
3.2	x86 architecture and signal description,	1
3.3	Physical memory organization	1
3.4	Bus operation	1
3.5	I/O addressing	1
3.6	Special processor activities, Modes of operations.	1
3.7	Addressing modes, Instruction sets	1
4	8086 special features and programming:	
4.1	Stack structure	1
4.2	Interrupt cycle, Maskable non-maskable interrupts	1
4.3	Assembler directives and Basic ASM program	1
4.4	interrupt programming	1
5	Basic peripherals and interfacing	
5.1	Programmable peripheral interface-(8255)	2
5.2	Programmable interval timer (8253)	1
5.3	Sample program for accessing peripherals	1

Course Designers:

1	Dr.K.Hariharan	khh@tce.edu
2	Dr. L.R.Karl Marx	lrk@tce.edu

14EC380	COMPUTER PROGRAMMING LABORATORY	Category	L	T	P	Credit
		PC	0	0	1	1

Preamble

This course is designed to complement the course 14EC320 *Problem Solving using Computer*. The purpose of this course is to give hands on training to the students in understanding and practicing the programming concepts and algorithms. This will improve the problem solving capability of the students.

Prerequisite

Nil

Course Outcomes

On the successful completion of the course, students will be able to

CO1	Write, compile, debug, link and execute C program for the given specification/application	Apply
CO2	Design and implement algorithms involving decision structures, loops, arrays and pointers.	Apply
CO3	Use different data structures for solving the given problem using computer	Apply
CO4	Create/update data files.	Apply
CO5	Analyze the implementation complexity of algorithm by modularizing the problem into small modules for the given problem	Analyze

Mapping with Programme Outcomes

COs	PO 1	PO 2	PO 3	PO 4	PO 5	PO 6	PO 7	PO 8	PO 9	PO 10	PO 11	PO 12	PSO 1	PSO 2	PSO 3
CO1	S	-	-	-	S	-	-	M	M	-	-	L	L	L	L
CO2	S	M	L	-	S	-	-	M	S	L	-	M	M	L	M
CO3	S	M	L	-	S	-	-	M	S	L	-	M	M	L	M
CO4	S	M	L	-	S	-	-	M	S	-	-	M	M	L	M
CO5	S	S	M	-	S	-	-	M	S	L	-	M	S	L	M

S- Strong; M-Medium; L-Low

Syllabus

1. Basic programs to understand different types of data, operators and expressions.
2. Programs using control structures
 - a. Factorial of a number
 - b. Fibonacci series
 - c. Generating prime numbers
 - d. Generating Armstrong numbers
 - e. Greatest common divisor
3. Programs using arrays
 - a. Merging of arrays
 - b. Array order reversal
 - c. Selection sort
 - d. Bubble sort
 - e. Insertion sort
4. Programs using strings
 - a. Palindrome checking

- b. String sorting
 - c. Linear pattern search
 - d. Text line editing
 - e. Finding frequency of vowels, consonants, numbers and blank spaces
5. Programs using functions
 - a. Base conversion
 - b. Linear search
 - c. Binary search
 - d. Matrix manipulation
 6. Programs using pointers
 - a. Statistical measures of an array
 - b. Matrix multiplication
 - c. Key word search
 7. Programs using structures
 - a. Employee database
 - b. Library management
 - c. Hospital management
 8. Programs using file structure
 - a. Creating, reading and copying a text file
 - b. Creating a data file
 - c. Searching a data file
 9. Team Project in ECE Domain

Course Designers:

1. Dr. R. A. Alaguraja alaguraja@tce.edu
2. Dr. S. Ponmalar spmece@tce.edu

14EC390	ELECTRONIC CIRCUIT DESIGN LABORATORY	Category	L	T	P	Credit
		PC	0	0	1	1

Preamble

The goal of this lab is to supplement the theory course 14EC330 Electronic Circuit Design. Students will gain experience in electronic circuits design for given specification. They will analyze and test electronic circuits using simulation software and laboratory instruments.

Prerequisite

Nil

Course Outcomes

On the successful completion of the course, students will be able to

CO1	Apply the fundamental principle of Quantum Mechanics and Solid State Physics to study the parameters of semiconductor materials.	Apply
CO2	Describe the relationship between electron transport properties and operation of semi conductor devices like Diode, Bipolar Junction Transistors and Field Effect transistors.	Apply
CO3	Investigate the different configuration and obtain the device small signal model of BJTs and FETs.	Analyze
CO4	Gain knowledge in the advanced development of low dimensional semiconductor hetero structures and their operation.	Analyze
CO5	Apply the concepts of transistor biasing to study the small signal behaviour of BJT and MOSFET for Amplification application.	Apply

Mapping with Programme Outcomes

COs	PO 1	PO 2	PO 3	PO 4	PO 5	PO 6	PO 7	PO 8	PO 9	PO 10	PO 11	PO 12	PSO 1	PSO 2	PSO 3
CO1	S	M	L	-	-	-	-	-	-	-	-	-	S	-	-
CO2	M	L	-	-	M	-	-	-	-	-	-	-	M	-	-
CO3	S	S	M	L	M	-	-	-	-	-	-	-	S	L	-
CO4	M	L	-	-	-	-	-	-	L	-	-	L	M	-	-
CO5	S	M	L	-	M	-	-	-	-	-	-	-	S	-	-

S- Strong; M-Medium; L-Low

List of Experiments

- Design, simulation and hardware realization of Single Stage common emitter amplifier for given specification
- Simulation of different types of current mirror circuits
- Design and simulation of Differential pair circuit with active load and current references and its frequency analysis.
- Design and hardware realization of Multistage Amplifier for given specification.
- Simulation of different types of feedback amplifiers and its frequency analysis.
- Design, Simulation and Hardware realisation of sinusoidal waveform generators.
 - RC Oscillators
 - LC Oscillators
- Frequency Response characterisation of Tuned amplifier circuit.
- Design and simulation of Power amplifiers.
- Miniproject

Course Designers:

- Dr. S. Rajaram rajaram_siva@tce.edu
- Mr. V. Vinoth Thyagarajan vvkece@tce.edu

CURRICULUM AND DETAILED SYLLABI

FOR

FOURTH SEMESTER

B.E. DEGREE PROGRAMME

IN
ELECTRONICS AND COMMUNICATION ENGINEERING



FOR THE STUDENTS ADMITTED IN THE
ACADEMIC YEAR 2014-15 ONWARDS

DEPARTMENT OF ELECTRONICS AND COMMUNICATION ENGINEERING
THIAGARAJAR COLLEGE OF ENGINEERING

(A Government Aided ISO 9001:2008 certified Autonomous Institution affiliated to Anna University)

MADURAI – 625 015, TAMILNADU

Phone: 0452 – 2482240, 41

Fax: 0452 2483427

Web: www.tce.edu

14EC410	NUMERICAL METHODS AND OPTIMIZATION	Category	L	T	P	Credit
		BS	2	2	0	3

Preamble

An engineering student needs to know some basic numerical tools and techniques. This course aims at providing all the necessary tools needed to solve the problems numerically that arise in their field.

Prerequisite

Nil

Course Outcomes

On the successful completion of the course, students will be able to

CO1: Solve the system of linear algebraic equations and nonlinear equations arising in the field of communication engineering	Analyze
CO2: Interpolate discrete data by means of continuous function.	Apply
CO3: Evaluate the integration of one and two variable functions using numerical tools and calculate derivatives using interpolation polynomial .	Apply
CO4: Find the solution for the IVPs in ODE using single step and multistep methods.	Analyze
CO5: Find the solution of BVPs in PDE using finite difference methods	Analyze
CO6: Optimize the given function using simplex methods	Apply
CO7: Optimize the given function using decent methods	Apply

Mapping with Programme Outcomes

COs	PO 1	PO 2	PO 3	PO 4	PO 5	PO 6	PO 7	PO 8	PO 9	PO 10	PO 11	PO 12	PSO 1	PSO 2	PSO 3
CO1	M	-	-	-	-	-	-	-	-	-	-	-	M	-	-
CO2	S	-	-	-	-	-	-	-	--	-	-	-	M	-	-
CO3	S	-	-	-	-	-	-	-	-	S	-	S	M	-	M
CO4	S	-	--	-	-	-	-	-	-	-	-	-	M	-	-
CO5	S	-	-	-	-	-	-	-	-	S	-	S	M	-	M
CO6	M	-	-	-	-	-	-	-	-	-	-	-	M	-	-
CO7	M	-	-	-	-	-	-	-	-	-	-	-	M		

S- Strong; M-Medium; L-Low

Assessment Pattern

Bloom's Category	Continuous Assessment Tests			Terminal Examination
	1	2	3	
Remember	10	10	10	0
Understand	30	30	30	30
Apply	60	60	60	70
Analyse	0	0	0	0
Evaluate	0	0	0	0
Create	0	0	0	0

Course Level Assessment Questions**Course Outcome 1(CO1):**

1. Give the physical significance of Newton's method.
2. Solve the following system of equations using Gauss-Seidel method : $10x-5y-2z = 3$;
 $4x-10y+3z = -3$; $x+6y+10z = -3$.
3. Solve the system of equations by Gauss Jordan method $x+ 2y+z=3$; $2x+3y+3z=10$;
 $3x-y+2z=13$.

Course Outcome 2 (CO2):

1. Find the values of y at $x=21$ and $x=28$ from the following data:

x	20	23	26	29
y	0.342	0.3907	0.4384	0.4848

2. Using Lagrange's interpolation formula, find $y(10)$ from the following table :

x	5	6	9	11
y	12	13	14	16

Course Outcome 3 (CO3)

1. Given the following data, find $y'(6)$ and the maximum value of y :

x	0	2	3	4	7	9
y	4	26	58	112	466	922

2. Evaluate $\int_0^1 e^x dx$ by Simpson's one-third rule correct to five decimal places, by proper choice of h.

3. Evaluate $\int_0^6 \frac{dx}{1+x^2}$ by Trapezoidal rule.

Course Outcome 4 (CO4):

1. Find $y(0.1)$, $y(0.2)$, $y(0.3)$ from $\frac{dy}{dx} = xy + y^2$, $y(0)=1$ by using Runge-Kutta fourth order method.
2. Using Milne's predictor corrector method find $y(4.4)$ given $5xy' + y^2 - 2 = 0$ given $y(4) = 1$, $y(4.1) = 1.0049$, $y(4.2) = 1.0097$ and $y(4.3) = 1.0143$.
3. Using finite difference method, solve $\frac{d^2y}{dx^2} = y$ in $(0,2)$ given $y(0) = 0$, $y(2) = 3.63$.

Course Outcome 5 (CO5):

1. Solve $\frac{\partial^2 u}{\partial x^2} - 2 \frac{\partial u}{\partial t} = 0$ given $u(0,t) = 0$, $u(4,t) = 0$, $u(x,0) = x(4-x)$. Assume $h = 1$. Find the values of u upto $t = 5$.
2. Solve numerically, $4 \frac{\partial^2 u}{\partial x^2} = \frac{\partial^2 u}{\partial t^2}$, with the boundary conditions $u(0,t) = 0$ and $u(4,t) = 0$, and the initial conditions $u_t(x,0) = 0$ and $u(x,0) = x(4-x)$, taking $h = 1$. (for 4 time steps).
3. Solve $u_{xx} + u_{yy} = 0$ over the square mesh of side 4 units, satisfying the following boundary conditions:
 - (i) $u(0,y) = 0$ for $0 \leq y \leq 4$
 - (ii) $u(4,y) = 12 + y$, for $0 \leq y \leq 4$
 - (iii) $u(x,0) = 3x$ for $0 \leq x \leq 4$
 - (iv) $u(x,4) = x^2$ for $0 \leq x \leq 4$.

Course Outcome 6 (CO6):

1. Using graphical method, solve the following L.P.P. : Maximize $Z = 2x_1 - 3x_2$ subject to $x_1 - x_2 \leq 2$, $x_1 + x_2 \geq 4$, $x_1, x_2 \geq 0$.
2. Using simplex method, Maximize $Z = 5x_1 + 3x_2$ subject to $x_1 + x_2 \leq 2$, $5x_1 + 2x_2 \leq 10$, $3x_1 + 8x_2 \leq 12$, $x_1, x_2 \geq 0$.

Course Outcome 7 (CO7):

1. Minimize $f(x_1, x_2) = x_1 - x_2 + 2x_1^2 + 2x_1x_2 + x_2^2$ using steepest decent method by taking the starting point as $X_1 = \begin{Bmatrix} 0 \\ 0 \end{Bmatrix}$.
2. Minimize $f(x_1, x_2) = x_1 - x_2 + 2x_1^2 + 2x_1x_2 + x_2^2$ using Newton's method by taking the starting point as $X_1 = \begin{Bmatrix} 0 \\ 0 \end{Bmatrix}$.
3. Show that the Newton's method finds the minimum of a quadratic function.

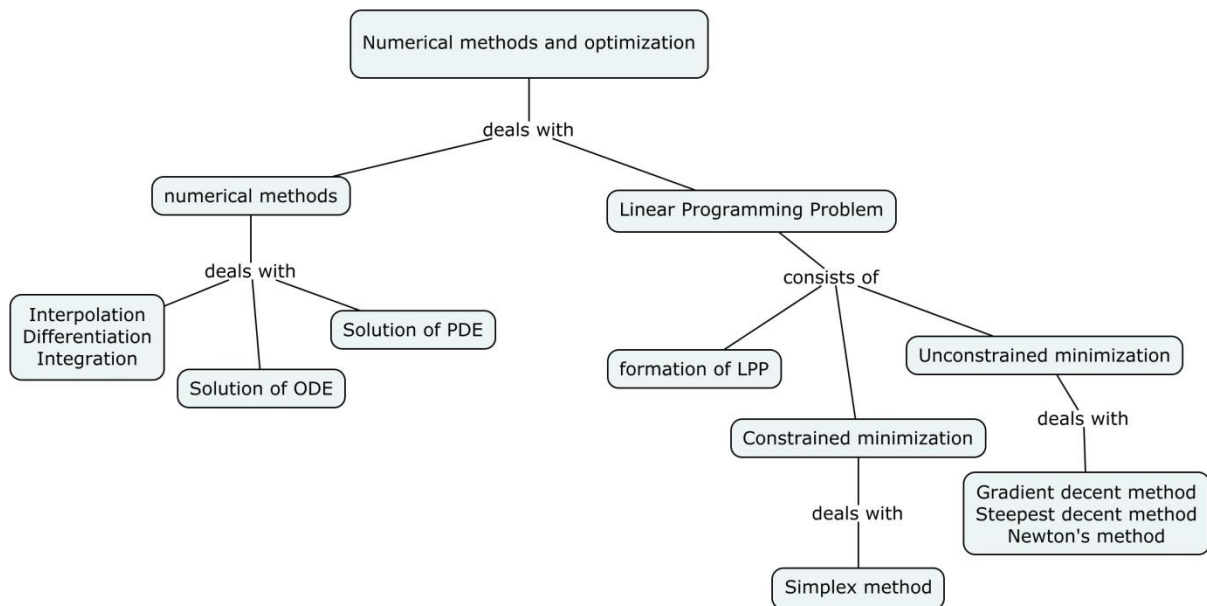
Concept Map**Syllabus**

Solution of System of Equations Interpolation, Differentiation and Integration: Newton-Raphson method, Gauss elimination and Gauss Jordan methods - Gauss Jacobi and Gauss Siedal methods - Inversion by Gauss Jordan method - Gauss's and Lagrange's interpolation formulae - Newton's forward formulae for derivatives - Trapezoidal, Simpson's 1/3 & 3/8 rules. Cubic Spline, Convergence of Solutions

Ordinary Differential Equations: Initial value problems - Runge – Kutta methods - Predictor corrector methods - Finite difference methods - Hermitian method.

Partial Differential Equations: Classification of PDEs – Solution of parabolic equations – Bender Schmidt, Crank Nicholson methods – Solution of hyperbolic equations by explicit scheme.

Optimization: LPP – Concave & convex steps, Global and Local optimization, Formation of LPP – Standard form of LPP, Graphical solution of LPP – Simplex method – Unconstrained minimization – Gradient Decent method – Steepest Decent method – Newton's method.

Text Books

1. Steven C. Chapra, Raymond P. Canale, " Numerical Methods for Engineers", Mc Graw Hill Higher Education, 2016.
2. S.R.K.Iyengar, R.K.Jain, Mahinder Kumar Jain, "Numerical methods for Scientific and Engineering Computations", New Age International publishers, 6th Edition 2012.
3. Sharma.J.K., " Operations Research: Theory and Applications", Macmillan India Ltd., Fourth Edition, 2009.
4. Hamdy A. Taha, " Operations Research – An Introduction", Macmillan Co., Seventh Edition, 2009

Reference Books:

1. S.K. Gupta, Numerical Methods for Engineers, New Age International, 2015.
2. Joe D. Hoffman, Steven Frankel, Numerical Methods for Engineers and Scientists, Third Edition, 2015.

Course Contents and Lecture Schedule

Module No.	Topic	No. of Lectures
1	SOLUTION OF SYSTEM OF EQUATIONS INTERPOLATION, DIFFERENTIATION AND INTEGRATION	
1.1	Newton-Raphson method, Gauss elimination and Gauss Jordan methods	2
	Tutorial	1
1.2	Gauss Jacobi and Gauss Seidel methods.	1
1.3	Inversion by Gauss Jordan method	1
	Tutorial	1
1.4	Gauss's and Lagrange's interpolation formulae	2
1.5	Newton's forward formulae for derivatives	2
	Tutorial	1
1.6	Trapezoidal, Simpson's 1/3 & 3/8 rules	1
1.7	Cubic Spline	1
1.8	Convergence of Solutions	1
	Tutorial	1
2	ORDINARY DIFFERENTIAL EQUATIONS	
2.1	Introduction – Initial value problems	1
2.2	Runge – Kutta methods	2
	Tutorials	1
2.3	Predictor corrector methods	2
2.4	Finite difference methods	2
2.5	Hermitian method	1
	Tutorials	1
3	PARTIAL DIFFERENTIAL EQUATIONS	
3.1	Introduction, Classification of PDEs	1
3.2	Solution of parabolic equations – Bender Schmidt, Crank Nicholson methods	3
	Tutorial	1
3.3	Solution of hyperbolic equations by explicit scheme	2
	Tutorial	1
4	OPTIMIZATION	
4.1	Introduction to LPP	1
4.2	Concave & convex steps, Formation of LPP	1
	Tutorial	1
4.3	Standard form of LPP, Graphical solution of LPP	2
	Tutorial	1
4.4	Simplex method	2
	Tutorial	1
4.5	Unconstrained minimization – Gradient Decent method - Steepest Decent method	2
	Tutorial	1
4.6	Newton's method	2
	Tutorial	1
	Total	48

Course Designers:

1	Dr.M.Mutharasan	mmmat@tce.edu
2	Dr..K.Angaleeswari	kangaleeswari@tce.edu
3	Dr.S.P.Suriya Prabha	suriyaprabha@tce.edu



14EC420	MICROCONTROLLERS	Category	L	T	P	Credit
		PC	3	0	0	3

Preamble

Microcontrollers based embedded systems are involved in almost every facet of modern life. Consumer gadgets, entertainments gadgets, medical devices and automobiles all contain embedded Microcontroller. The tremendous number of applications for embedded computing has given rise to high demand for engineers with experience in designing and implementing embedded systems with microcontroller. This course is designed to provide an introduction to microcontroller architecture, internal and external peripherals, assembly language programming and embedded c programming. Students will be taught the basic use of a programming environment and how to develop the basic C programming for embedded application. This course highlights the general interfacing techniques and concepts through peripheral's data representation from input/output, and memory usage in the microcontroller in embedded C.

Prerequisite

14EC370 Microprocessor Architecture and Programming

Course Outcomes

On the successful completion of the course, students will be able to

CO1	Distinguish between the feature of the microprocessor and microcontroller in various of its types	Understand
CO2	List and describe the peripherals in a microcontroller	Understand
CO3	Illustrate the external peripherals interfacing with an ASM and C programming	Understand
CO4	Explain the use of peripherals with its various modes of operation	Understand
CO5	Illustrate the interrupts handling and demonstrate peripherals applications in C for the target 8051 board	Apply
CO6	Demonstrate an application by accessing the peripherals in C programming of the target Galileo board	Apply

Mapping with Programme Outcomes

COs	PO 1	PO 2	PO 3	PO 4	PO 5	PO 6	PO 7	PO 8	PO 9	PO 10	PO 11	PO 12	PSO 1	PSO 2	PSO 3
CO1	M	L	-	-	-	-	-	L	M	L	-	-	L	-	-
CO2	M	L	-	-	-	-	-	L	M	L	-	-	L	-	-
CO3	S	M	L	-	-	-	-	L	M	L	-	L	M	-	L
CO4	S	M	L	-	-	-	-	L	M	L	-	L	M	-	L
CO5	S	M	L	-	-	-	-	M	L	L	-	L	M	-	L
CO6	S	M	L	-	-	-	-	L	M	L	-	L	M	-	L

S- Strong; M-Medium; L-Low

Assessment Pattern

Bloom's category	Continuous Assessment Tests			End Semester Examinations
	1	2	3	
Remember	20	20	20	10
Understand	40	40	40	40
Apply	40	40	40	50
Analyze	0	0	0	0
Evaluate	0	0	0	0
Create	0	0	0	0

Course Level Assessment Questions

Course Outcome 1 (CO1):

1. Distinguish between 8085 microprocessor and 8051 microcontroller
2. List the microcontrollers in intel
3. Define the functionality of CPU in microprocessor and microcontroller
4. Distinguish between 8 bit and 16 bit microcontroller

Course Outcome 2 (CO2)

1. Define the functionality of timer peripherals in a microcontroller
2. List the internal peripherals present in 8051
3. Define the functionality of a serial peripheral in 8051
4. Show that how do you access the peripherals in 8051

Course Outcome 3(CO3):

1. Demonstrate the timer peripheral in mode 1 operation
2. Give an example for accessing serial peripheral in polling driven
3. Describe the use of serial peripheral in asm programming
4. Develop a C program for a described value of time delay

Course Outcome 4 (CO4):

1. Demonstrate the timer peripherals with mode 1 and mode 2
2. Give an example for accessing timer in asm and C program
3. Describe the functionality of the GPIO hardware for accessing IO device
4. Distinguish between timer and counter in its modes of operation

Course Outcome 5 (CO5):

1. Illustrate the serials peripherals for transmitting the data in defined baud rate
2. Show the program for accessing a ADC and show it in LED display
3. Demonstrate the operation of keyboard interfacing with 8051 board
4. Construct the program for interfacing LCD module with 8051 board

Course Outcome 6 (CO6):

1. Illustrate the arduino sketch program that how to handle interrupts in Intel Galileo board
2. Show the sketch program for accessing a analog sensor and send the data to serial port in Intel
3. Demonstrate the operation of arduino program for interfacing analog sensor with WIFI shield and make the system to IOT.
4. Construct the sketch program for accessing blue tooth for IOT application

Concept Map

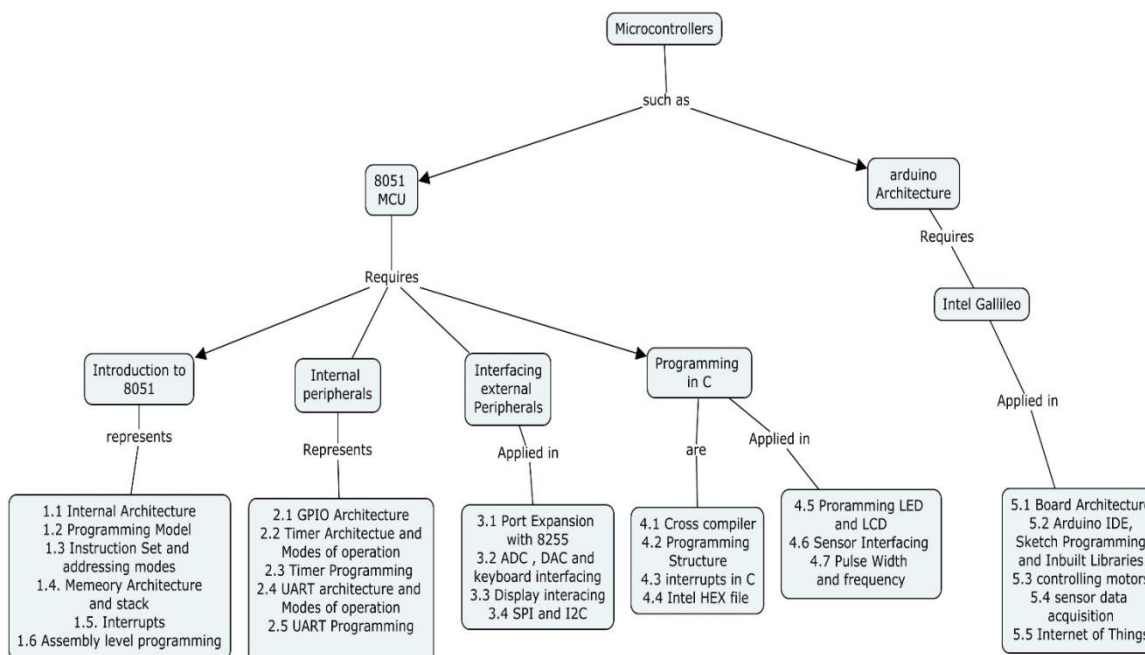

Syllabus

Microcontrollers: 8051 Microcontroller architecture, programming model, instructions sets and addressing modes. Memory organization, stack structure and Interrupts. Assembly level program for arithmetic operations.

Internal-peripherals: GPIO architecture, Timer architecture and modes of operation, Timer peripheral programming, UART and modes of operation. UART programming by polling and interrupt driven.

External peripherals interfacing: Port expansion with 8255. ADC, DAC, Keyboard interfacing. Display interfacing LED 7 segment and LCD module. SPI and I2C architecture.

Programming in C: Cross compiler C -programming structure, Data types, memory models, infinite loops and handling interrupts in C. Intel Hex file format. C-Programming for LED, LCD display, temperature sensor with ADC, Measuring pulse width and frequency.

Intel Galileo - Arduino programming: Galileo Board overview - Arduino IDE, Sketch programming and In-built libraries. Controlling DC motor, stepper motor and servo motor Acquisition of temperature data and send it to serial port. WIFI and Blue tooth shield. Application in Internet of Things (IoT).

Text Books:

1. Kenneth J. Ayala, "The 8051 Microcontroller. Architecture, Programming and Applications", West publishing company 2014
2. Muhammad Ali Mazidi, Janice Gillespie Mazidi, Rolin D.Mckinlay , "The 8051 Microcontroller and Embedded systems Using Assembly and C", Second Edition, Pearson Education,2013
3. Matt Richardson, "Getting started with Intel Galileo", 2014

Reference Books:

1. Myke Predko, "Programming and Customizing the 8051 Microcontroller", 1st Edition, 2012.
2. Chris Braith, "8051 Microcontroller Application based Introduction", Elsevier 2004.

Course Contents and Lecture Schedule		
No	Topic	No. of Lectures
1	8051 microcontrollers	
1.1	8051 Micro-controller architecture	2
1.2	Programming model	1
1.3	Instructions sets and addressing modes	3
1.4	Memory organization, stack structure	1
1.5	Interrupts	1
1.6	Assembly level program for arithmetic operations	2
2	Internal peripherals	
2.1	GPIO architecture	1
2.2	Timer architecture and modes of operation	1
2.3	Timer peripheral programming	1
2.4	UART and modes of operation	1
2.5	UART programming by polling and interrupt driven	1
3	External peripherals interfacing	
3.1	Port expansion with 8255	1
3.2	ADC, DAC, Keyboard interfacing	3
3.3	Display interfacing- LED, 7 segment and LCD module	2
3.4	SPI and I2C architecture	2
4	Programming in C	
4.1	Cross compiler	1
4.2	Programming structure, Data types	1
4.3	Infinite loops and handling interrupts in C	1
4.4	Intel Hex file format	1
4.5	C-Programming for LED, LCD display	1
4.6	Temperature sensor with ADC	1
4.7	Measuring pulse width and frequency	2
5	Intel Galileo - Arduino programming	
5.1	Galileo Board overview	1
5.2	Arduino IDE, Sketch programming and In-built libraries	1
5.3	Controlling DC motor, stepper motor and servo motor	2
5.4	Acquisition of temperature data and send it to serial port	2
5.5	WIFI and Blue tooth shield	2
5.6	Application in Internet of Things (IOT).	2
	Total	41

Course Designers:

1. Dr.K.Hariharan khh@tce.edu
2. Dr.L.R.Karlmarx lrkarlmarx@tce.edu
3. Mr.S.Parthasarathi parthasarathi_s@tce.edu

15EC431	RF TRANSMISSION LINES AND PASSIVE CIRCUITS	Category	L	T	P	Credit
		PC	3	0	0	3

Preamble

This course aims to provide students with the technological skills needed in understanding the behaviour of two wire line, planar transmission lines and the design of RF passive circuits.

Prerequisite

14EC350 Electromagnetics

Course Outcomes

On the successful completion of the course, students will be able to

CO1. Analyse different transmission line characteristics.	Analyse
CO2. Compute losses in a transmission line and find various parameters of the line	Apply
CO3. Understand the behaviour of passive components at higher frequencies	Understand
CO4. Design RF Passive components - filters, couplers and power dividers	Apply
CO5. Design duplexers for cellular applications.	Apply

Mapping with Programme Outcomes

COs	PO 1	PO 2	PO 3	PO 4	PO 5	PO 6	PO 7	PO 8	PO 9	PO 10	PO 11	PO 12	PSO 1	PSO 2	PSO 3
CO1	S	S	M	-	M	-	-	-	L	-	-	-	L	-	L
CO2	S	M	L	-	M	-	-	-	L	-	-	-	-	-	-
CO3	M	L	-	-	M	-	-	-	-	-	-	-	-	-	-
CO4	S	M	L	-	-	-	-	-	-	-	-	L	L	-	L
CO5	S	M	L	-	-	-	-	-	L	-	-	L	L	-	L

S- Strong; M-Medium; L-Low

Assessment Pattern

Bloom's Category	Continuous Assessment Tests			Terminal Examination
	1	2	3	
Remember	0	0	0	0
Understand	20	20	20	20
Apply	80	80	80	80
Analyse	0	0	0	0
Evaluate	0	0	0	0
Create	0	0	0	0

Course Level Assessment Questions**Course Outcome 1 (CO1):**

- To appreciate the importance of fractional wavelength, consider an $l = 1.27 \text{ cm} = 0.5$ in long conductor laid out on a PCB board, with $\epsilon_{\text{eff}} = 2.25$. How should this conductor be treated at 10 MHz, 100 MHz and 1GHz ?
- Why microstrip lines cannot support pure TEM mode of propagation ?
- Classify planar transmission lines along with their mode of propagation and field variations..

Course Outcome 2 (CO2):

- A lossless transmission line of electrical length $l = 0.3\lambda$ is terminated with a complex load impedance as shown below. Find the reflection coefficient at the load, the SWR

on the line, the reflection coefficient at the input of the line and the input impedance to the line.

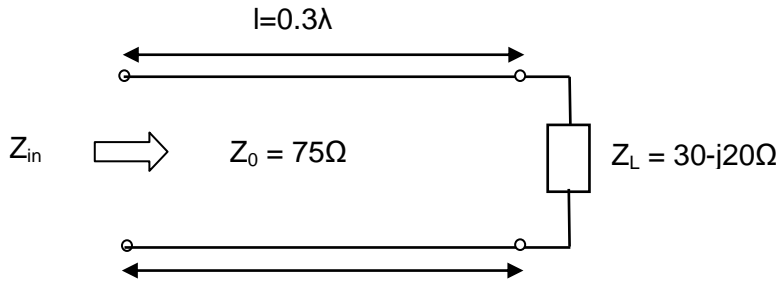

2. A lossless transmission line is terminated with a 100Ω load. If the SWR on the line is 1.5, find the two possible values for the characteristic impedance of the line.
3. A radio transmitter is connected to an antenna having an impedance of $80 + j40\Omega$ with a 50Ω coaxial cable. If the 50Ω transmitter can deliver 30W when connected to a 50Ω load, how much power delivered to the antenna?
4. A 75Ω coaxial transmission line has a length of 2 cm and is terminated with a load impedance of $37.5 + j75\Omega$. If the dielectric constant of the line is 2.56 and the frequency is 3.0 GHz, find the input impedance to the line, reflection coefficient at the load, the reflection coefficient at the input and the SWR on the line.

Course Outcome 3 (CO3):

1. Design a stripline transmission line for 100 ohms characteristic impedance. The ground plane separation is 0.316 cm and the dielectric constant of the filling material is 9.8. If the dielectric loss tangent is 0.001 and the operating frequency is 5 GHz. Calculate the attenuation in dB/λ. Assume a conductor thickness of $t = 0.01$ mm.
2. Calculate the width and length of the microstrip line for 75 ohms characteristic impedance and a 90 degree phase shift at 3.5 GHz. The substrate thickness is $d = 0.127$ cm, with $\epsilon_r = 2.20$.

Course Outcome 4 (CO4):

1. Find the S parameters of the 3 dB attenuator circuit shown in figure

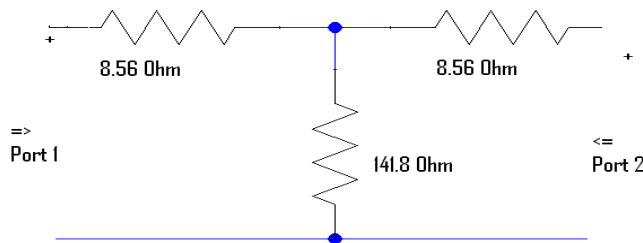

2. Determine the scattering matrix for each of the lossless transmission lines shown below, relative to a system impedance of Z_0 . Verify that each matrix is unitary.



- Find the S parameters for the series and shunt loads shown below. Show that $S_{12}=1-S_{11}$ for the series case and that $S_{12}=1+S_{11}$ for the shunt case. Assume characteristic impedance Z_0 .

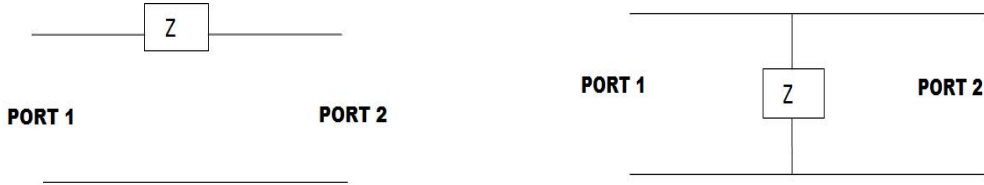

- Verify that [S] matrix for a reciprocal network is symmetric and [S] matrix for a loss less network is unitary.

Course Outcome 5 (CO5):

- A lossless T junction power divider has a source impedance of 50 ohms. Find the output characteristic impedances so that the input power is divided in a 2:1 ratio. Compute the reflection coefficients seen looking into the output ports.
- Design a maximally flat low pass filter with a cut-off frequency of 2 GHz, impedance 50Ω , and at least 15 dB insertion loss at 3 GHz.
- Design a stepped impedance low pass filter having a maximally flat response and a cut off frequency of 2.5 GHz. It is necessary to have more than 20 dB insertion loss at 4 GHz, the filter impedance is 50Ω , the highest impedance is 150Ω and the lowest is 10Ω .

Course Outcome 6 (CO6):

- Design a bandpass filter having 0.5 dB equal ripple response with $N=3$. The Center frequency is 1GHz, the fractional bandwidth 10% and the impedance is 50Ω .
- Design a band pass filter with a single resonant circuit for a center frequency of 500 MHz and a desired 3 dB bandwidth of 50 MHz. Use a 50Ω source and 50Ω load terminations. Also show the changes caused by finite component Q's of 80 at 500 MHz. Plot the response and show the changes from 450 MHz to 550 MHz.

Concept Map

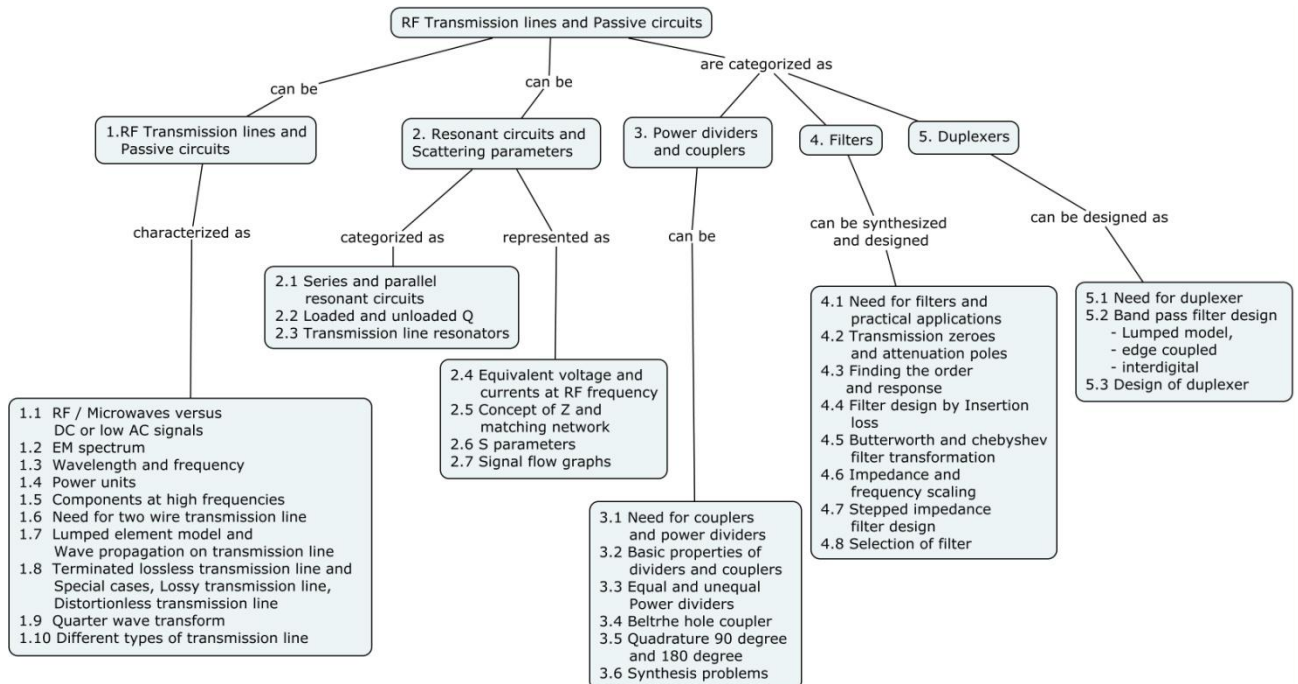

Syllabus

RF Transmission Lines and Passive Circuits: RF/Microwaves versus DC or Low AC signals, EM Spectrum, Wavelength and Frequency, Power units, Components at high frequencies – Wire, Resistor, Capacitor, Inductor, Transmission Lines, Need for two wire Transmission Line, Lumped element circuit model for a transmission line- Wave propagation on a transmission line, Terminated lossless transmission line, Special cases of lossless transmission line, Lossy transmission line, Distortionless transmission line, Terminated lossy line & Quarter wave transformer, Different types of transmission line – coaxial, waveguide, planar transmission line –Design of microstrip lines. **Resonant circuits:** Series and parallel resonant circuits, Loaded and unloaded Q, Transmission line resonators, Equivalent voltage and current at RF frequency, Concept of Z and matching network, S parameters, Signal flow graphs. **Power dividers and couplers:** Need for couplers and Power dividers, Basic properties of dividers and couplers, Equal and unequal power dividers, Quadrature 90°, Rat race 180°, Synthesis problems – Sum and Difference problems. **Filters:** Need for filters and practical applications, Transmission zeros and attenuation poles, Finding the order of filter and response, Filter design by insertion loss method, Butterworth and Chebyshev filter transformations, Impedance and frequency scaling, Stepped impedance filter design, Selection of filter based on data sheet. **Duplexers :** Need for duplexers, Band pass filter design, Design a duplexer for GSM (or) Cellular applications (Mini project).

Text Book

1. Matthew M. Radmanesh, "Radio frequency and Microwave Electronics Illustrated", Pearson Education Asia, 2001
2. David M. Pozar, "Microwave Engineering," John Wiley & Sons, Fourth Edition, 2015.

Reference Books

1. David M Pozar: Microwave and RF design of wireless systems, John Wiley & Sons, 2001.
2. Les Besser and Rowan Gilmore, "Practical RF circuit Design for Modern Wireless Systems- Passive circuits and Systems", Vol.1, Artech House Publishers, Boston, London 2008.

Course Contents and Lecture Schedule

Sl. No:	Topic	No. of Lectures
1	RF TRANSMISSION LINES & PASSIVE CIRCUITS	
1.1	RF/Microwaves versus DC or Low AC signals	1
1.2	EM Spectrum	1
1.3	Wavelength and Frequency	1
1.4	Power units	1
1.5	Components at high frequencies – Wire, Resistor, Capacitor, Inductor	1
1.6	Transmission Lines - Need for two wire Transmission Line	1
1.7	Lumped element circuit model for a transmission line, Wave propagation on a transmission line	2
1.8	Terminated lossless transmission line, Special cases of lossless transmission line, Lossy transmission line, Distortionless transmission line	2
1.9	Terminated lossy line & Quarter wave transformer	1
1.10	Different types of transmission line – coaxial, waveguide, planar transmission lines	1
1.11	Design of Microstrip lines	1

2	Resonant circuits and Scattering parameters	
2.1	Series and parallel resonant circuits	1
2.2	Loaded and unloaded Q	1
2.3	Transmission line resonators	1
2.4	Equivalent voltage and current at RF frequency	1
2.5	Concept of Z and matching network	1
2.6	S parameters	1
2.7	Signal flow graphs	1
3	Power dividers and couplers	
3.1	Need for couplers and Power dividers	1
3.2	Basic properties of dividers and couplers	1
3.3	Equal and unequal power dividers	1
3.4	Quadrature 90°, Rat race 180°	1
3.5	Synthesis problems – Sum and Difference problems	1
4	Filters	
4.1	Need for filters and practical applications	1
4.2	Transmission zeros and attenuation poles	1
4.3	Finding the order of filter and response	1
4.4	Filter design by insertion loss method	1
4.5	Butterworth and Chebyshev filter transformations	1
4.6	Impedance and frequency scaling, Stepped impedance filter design, Selection of a filter based on data sheet	1
5	Duplexers	
5.1	Need for duplexers	1
5.2	Band pass filter design- Lumped model	1
5.3	Design a duplexer for GSM (or) Cellular applications (Mini project)	3
	Total	36

Course Designers:

1.	Dr.V.Abhai kumar	principal@tce.edu
2.	Dr.S.Kanthamani	skmece@tce.edu

14EC440	SIGNAL PROCESSING	Category	L	T	P	Credit
		PC	2	1	0	3

Preamble

Signal processing is concerned with the representation, transformation and manipulation of signals and the information they contain. It is an area of science and engineering that has developed rapidly over the past few decades. The novel algorithms by Cooley and Tukey (1965) for efficient computation of Fourier transform provided a new point of view towards a discrete time signal processing. This course aims at the analysis and design of signal processing systems and computational techniques.

Prerequisite

14EC340 Signals and Systems

Course Outcomes

On the successful completion of the course, students will be able to

CO1. Compute DFT and IDFT coefficients of a given discrete time sequence using Fast Fourier Transform algorithms	Apply
CO2. Design IIR digital filters from analog filters namely Butterworth, Chebyshev and elliptic for a given specification	Apply
CO3. Design Linear phase FIR digital filters using windowing and frequency sampling methods	Apply
CO4. Draw the implementation structure of IIR and FIR discrete time systems using block diagram and signal flow graph representation.	Apply
CO5. Compute statistical parameters like mean, correlation and power spectral density of a given random variable or random processes at the output of a LTI system	Apply
CO6. Analyze the spectral characteristics of time dependent and random signals	Analyze
CO7. Design LTI systems for noise reduction & signal enhancement, linear prediction and analyzing the effects of finite precision representation of system coefficients and truncation/rounding of intermediate computation.	Analyze

Mapping with Programme Outcomes

COs	PO	PO	PO	PO	PO	PO	PO	PO	PO	PO	PO	PO	PSO	PSO	PSO
	1	2	3	4	5	6	7	8	9	10	11	12	1	2	3
CO1	S	M	L	-	-	-	-	-	L	L	-	-	S	L	L
CO2	S	M	L	-	-	-	-	-	L	L	-	-	S	L	L
CO3	S	M	L	-	-	-	-	-	L	L	-	L	S	L	L
CO4	S	M	L	-	-	-	-	-	L	L	-	L	S	M	L
CO5	S	M	L	-	-	-	-	-	L	L	-	L	S	M	L
CO6	S	S	M	L	-	-	-	-	L	L	-	L	S	M	L
CO7	S	S	M	L	-	-	-	-	L	L	-	L	S	S	L

S- Strong; M-Medium; L-Low

Assessment Pattern

Bloom's Category	Continuous Assessment Tests			Terminal Examination
	1	2	3	
Remember	20	0	0	0
Understand	20	20	20	20
Apply	60	60	60	60
Analyse	0	20	20	20
Evaluate	0	0	0	0

Create	0	0	0	0
--------	---	---	---	---

Course Level Assessment Questions

Course Outcome 1 (CO1):

- Determine the Fourier transform $X(\omega)$ of the signal $x(n) = \{1, 2, 3, 2, 1, 0\}$
 - Compute the 6 point DFT $V(k)$ of the signal $v(n) = \{3, 2, 1, 0, 1, 2\}$
 - Is there any relation between $X(\omega)$ and $V(k)$?
- Consider the sequences

$$x_1(n) = \{0, 1, 2, 3, 4\}, \quad x_2(n) = \{0, 1, 0, 0, 0\}$$

$$s(n) = \{1, 0, 0, 0, 0\}$$
 - Determine a sequence $y(n)$ so that $Y(k) = X_1(k)X_2(k)$.
 - Is there a sequence $x_3(n)$ such that $S(k) = X_1(k)X_3(k)$?
- Determine the eight point DFT of the signal $x(n) = \{1, 1, 1, 1, 1, 0, 0\}$ using DIF and DIT algorithms.

Course Outcome 2 (CO2):

- For the analog transfer function $H_a(s) = \frac{2}{(s+1)(s+2)}$, Determine $H(z)$ if $T=1$ Sec, by means of the impulse invariant method.
- Convert the analog filter with system transfer function $H_a(s) = \frac{(s+0.1)}{(s+0.1)^2 + 9}$ in to digital IIR bilinear transformation.
- Determine the order and poles of a type I Chebyshev lowpass filter that has a 1dB ripple in the passband, a cutoff frequency of 1000π , a stopband frequency of $\Omega_s = 2000\pi$ and attenuation of 40dB or more for $\Omega > \Omega_s$

Course Outcome 3 (CO3):

- A FIR linear phase, digital low pass filter is to be designed with a cutoff frequency of $\frac{\pi}{4}$ rad.
 - Determine the coefficients of a 7-tap filter based on the windowing technique with a Hamming window
 - Determine and plot the magnitude and phase response of the filter.
 - What will happen to the magnitude response if the taps of the filter increases to 11.
- Design an FIR low pass filter satisfying the specifications

$$0.95 < H(e^{j\omega}) < 1.05, \quad 0 \leq |\omega| \leq 0.25\pi$$

$$-0.1 < H(e^{j\omega}) < 0.1, \quad 0.35\pi \leq |\omega| \leq \pi$$

By applying a window $w[n]$ to the impulse response $h_d[n]$ for the ideal discrete time low pass filter with cutoff $\omega_c = 0.3\pi$. Which of the window can be used to meet the specification? For each window that you claim will satisfy this specification, give the minimum length $M+1$ required for the filter.

3. Determine the unit sample response $h[n]$ of a linear phase FIR filter of length $M = 4$ for which the frequency response at $\omega = 0$ and $\omega = \pi/2$ is specified as

$$H_r(0) = 1, H_r\left(\frac{\pi}{2}\right) = \frac{1}{2}$$

Course Outcome 4 (CO4):

1. Determine a direct form realization for the following linear phase filters:

a. $h[n] = \{1, 2, 3, 4, 3, 2, 1\}$

b. $h[n] = \{1, 2, 3, 3, 2, 1\}$

2. Consider an FIR filter with system function $H(z) = 1 + 2.88z^{-1} + 3.4048z^{-2} + 1.74z^{-3} + 0.4z^{-4}$. Sketch the direct form and lattice realizations of the filter and determine in detail the corresponding input-output equations. Is the system minimum phase?

3. Determine all the FIR filters which are specified by the lattice parameters $K_1 = \frac{1}{2}$,

$$K_2 = 0.6, K_3 = -0.7 \text{ and } K_4 = \frac{1}{3}$$

Course Outcome 5 (CO5):

1. Consider the sinusoidal process $X(t) = A \cos(2\pi f_c t)$ where the frequency f_c is constant and the amplitude A is uniformly distributed: $f_A(a) = \begin{cases} 1, & 0 \leq a \leq 1 \\ 0, & \text{otherwise} \end{cases}$. Determine whether or not this process is strictly stationary.

2. Prove the following two properties of the autocorrelation function $R_X(\tau)$ of a random process $X(t)$:

a. If $X(t)$ contains a DC component equal to A , then $R_X(\tau)$ will contain a constant component equal to A^2 .

b. If $X(t)$ contains a sinusoidal component, then $R_X(\tau)$ will also contain a sinusoidal component of the same frequency

3. Consider two linear filters connected in cascade as shown in Figure. Let $X(t)$ be a stationary process with autocorrelation function $R_X(\tau)$. The random process appearing at the first filter output is $V(t)$ and the second filter output $Y(t)$.

a. Find the autocorrelation function of $Y(t)$.

b. Find the cross correlation function $R_{VY}(\tau)$ of $V(t)$ and $Y(t)$.

Course Outcome 6 (CO6):

1. A real continuous time signal $x_c(t)$ is bandlimited to frequencies below 5 kHz; i.e., $X_c(j\Omega) = 0$ for $|\Omega| \geq 2\pi(5000)$. The signal $x_c(t)$ is sampled with a sampling rate of

10,000 samples per second (10 kHz) to produce $x[n] = x_c[nT]$ with $T = 10^{-4}$. Let $X[k]$ be the 1000 point DFT of $x[n]$.

- a. To what continuous time frequency does the index $k = 150$ in $X[k]$ correspond?
 - b. To what continuous time frequency does the index $k = 800$ in $X[k]$ correspond?
2. Let $x[n]$ be a 5000 point sequence obtained by sampling a continuous time signal $x_c(t)$ at $T = 50\mu s$. Suppose $X[k]$ is the 8192 point DFT $x[n]$. What is the equivalent frequency spacing in continuous time of adjacent DFT samples?
 3. A continuous time signal is sampled at a sampling rate of 10 kHz, and the DFT of 1024 samples is computed. Determine the frequency spacing between spectral samples. Justify your answer.
 4. Show that the time dependent Fourier transform has the following properties:
 - a. Linearity: If $x[n] = ax_1[n] + bx_2[n]$ then $X[n, \lambda] = aX_1[n, \lambda] + bX_2[n, \lambda]$
 - b. Shifting: If $y[n] = x[n - n_0]$, then $Y[n, \lambda] = X[n - n_0, \lambda]$.
 - c. Modulation: If $y[n] = e^{j\omega_0 n} X[n, \lambda - \omega_0]$

Course Outcome 7 (CO7):

1. Design a 2-pole resonator with peak $f_0 = 500\text{Hz}$ and width $\Delta f = 32\text{Hz}$ operating at a sampling rate of $f_s = 10\text{kHz}$. Draw its magnitude response and Impulse response.
2. Design a peaking digital IIR filter operating at a rate of 10kHz that has a peak at 1.75kHz and 3dB width of 500Hz. Then redesign it such that 500Hz represents its 10 dB width. For the 3 dB width care, determine also the corresponding complementary notch filter.
3. Consider the four comb filters: $y(n) = x(n) + x(n-8)$, $y(n) = x(n) - x(n-8)$, $y(n) = x(n) + x(n-8) + x(n-16)$, $y(n) = x(n) - x(n-8) + x(n-16)$. Determine their transfer functions and their impulse responses. Place their zeros on the z-plane relative to the unit circle. Sketch their magnitude responses. How are they similar or different? Draw their canonical realization forms using 8-fold delays z^{-8} . Write the corresponding sample processing algorithms both in their linear and circular buffer versions.

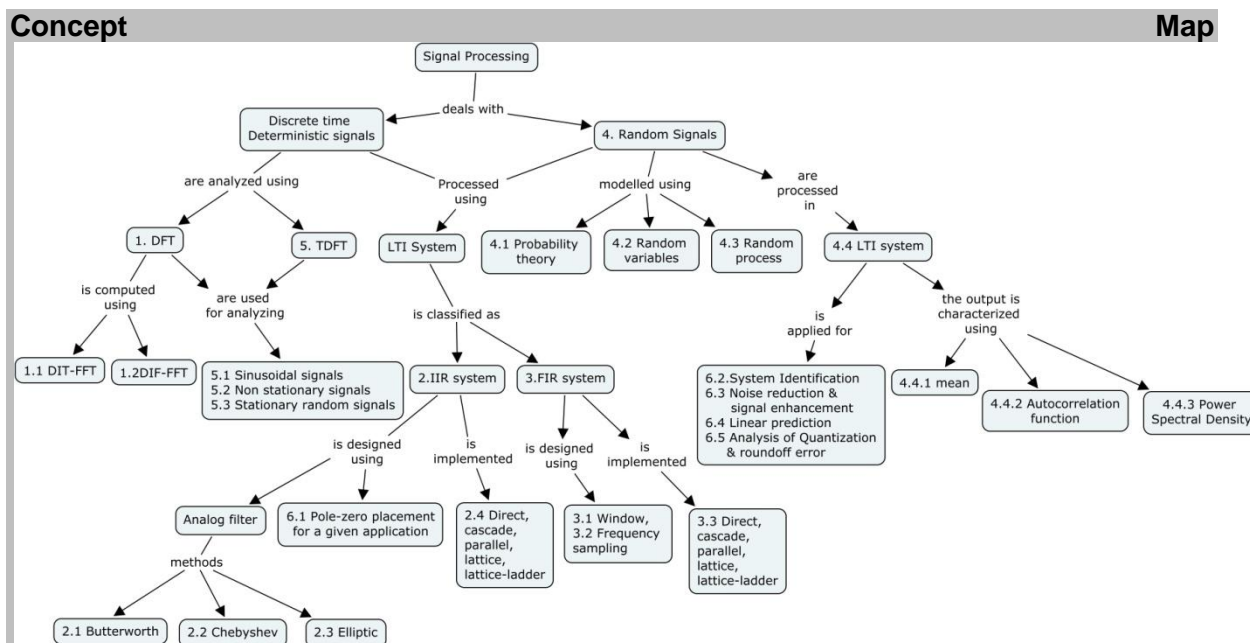

Syllabus

Discrete Fourier Transform (DFT): Fourier representation of Finite duration sequences, Properties of DFT, Linear Convolution using DFT, Direct computation of the DFT, Decimation-in Time and Decimation in frequency FFT algorithms.

IIR Filter Design Techniques: Filter specifications, Design of Discrete time IIR filters from continuous time filters: Impulse invariance, Bilinear transformation techniques, Discrete time Butterworth, Chebyshev and Elliptic filters, Basic structures for IIR filters: Direct, cascade, parallel, lattice and lattice-ladder.

FIR Filter Design Techniques: Filter specifications, Design of FIR filters by Windowing, Frequency sampling method, Basic network structures for FIR filters: Direct, cascade, lattice and Linear phase FIR form

Random signals: Probabilistic concept, random variables, statistical averages, random process: definition, stationary process, mean, correlation and covariance functions, ergodic process, transmission of random process through LTI systems, power spectral density, Gaussian process, noise, narrow band noise.

Fourier analysis of signals using DFT: DFT analysis of sinusoidal signals, time dependent Fourier transform (TDFT), block convolution using TDFT, Fourier analysis of non stationary signals: speech, radar signals Fourier analysis of stationary random signals: the periodogram, spectrum analysis of random signals.

Applications: Filter design based on Pole/zero: First order filters, Parametric resonators and equalizers, Notch and Comb filters, Effects of coefficient quantization, effects of roundoff noise in digital filters, noise reduction and signal enhancement, linear prediction

Text Books

1. Alan V.Oppenheim, Ronald W. Schaffer, "Discrete time signal processing", Prentice Hall, Third Edition, 2009.
2. Simon Haykin, "Communication systems" John Wiley & Sons, Fourth Edition, 2006

Reference Books

1. John G.Proakis and Dimitris G.Manolakis, "Digital Signal Processing Principles, Algorithms and Applications", Prentice-Hall of India, Fourth Edition, 2006.
2. Vinay K.Ingle and John G.Proakis, "Digital Signal Processing using MATLAB" CL Engineering, Third Edition, 2011
3. Sophocles J.Orfanidis "Introduction to Signal Processing", Prentice Hall, 1996.

4. John G.Proakis and Masoud Salehi, "Communication Systems Engineering" Prentice Hall, Second Edition, 2002.

Course Contents and Lecture Schedule

No.	Topic	No. of Lectures
1	Discrete Fourier Transform (DFT)	
1.1	Fourier representation of Finite duration sequences	1
1.2	Properties of DFT	1
1.3	Linear Convolution using DFT,	1
1.4	Direct computation of the DFT: Decimation-in Time and	2
1.6	Decimation in frequency FFT algorithms.	2
1.7	Tutorial	1
2	IIR Filter Design Techniques	
2.1	Filter specifications	1
2.2	Design of Discrete time IIR filters from continuous time filters: Impulse invariance,	1
2.3	Bilinear transformation techniques,	1
2.4	Discrete time Butterworth, Chebyshev and Elliptic filters	2
2.5	Basic structures for IIR filters: Direct, cascade, parallel,	1
2.6	lattice and lattice-ladder	1
	Tutorial	1
3	FIR Filter Design Techniques	
3.1	Filter specifications	1
3.2	Design of FIR filters by Windowing	2
3.3	Frequency sampling method	1
3.4	Basic network structures for FIR filters: Direct, cascade,	1
3.5	Lattice and Linear phase FIR form	2
3.6	Tutorial	1
4	Random signals	
4.1	Probabilistic concept, random variables, statistical averages,	2
4.2	Random process: definition, stationary process, mean, correlation and covariance functions,	2
4.3	Ergodic process,	1
4.4	Transmission of random process through LTI systems,	1
4.5	Power spectral density, Gaussian process, noise, narrow band noise.	1
4.6	Tutorial	1
5	Fourier analysis of signals using DFT	
5.1	DFT analysis of sinusoidal signals	1
5.2	Time dependent Fourier transform (TDFT)	1
5.3	Block convolution using TDFT	2
5.4	Fourier analysis of non stationary signals: speech, radar signals	2
5.5	Fourier analysis of stationary random signals: the periodogram, spectrum analysis of random signals.	1
	Tutorial	1
6	Applications	
6.1	Filter design based on Pole/zero: First order filters	1
6.2	Parametric resonators and equalizers	1
6.3	Notch and Comb filters	1
6.4	Effects of coefficient quantization	1

6.5	Effects of roundoff noise in digital filters	1
6.6	noise reduction and signal enhancement	1
6.7	linear prediction	1
6.8	Tutorial	1
	Total	48

Course Designers:

1	Dr.S.J.Thiruvengadam	sjtece@tce.edu
2.	Dr.P.G.S.Velmurugan	pgsvels@tce.edu



14EC450	ENGINEERING BY DESIGN	Category	L	T	P	Credit
		PC	1	0	2	3

Preamble

The purpose of this course is to apply the concept of mathematics, science and engineering fundamentals and an engineering specialization to solve complex engineering problems. The students learn an integrated overview of design principles, Engineering and Systems, Design Taxonomy and Design Thinking.

Prerequisite

Nil

Course Outcomes

On the successful completion of the course, students will be able to

CO1	Explain engineering and the qualities required in an engineering solution and in an engineer	Understand
CO2	Identify the need and define the problem statement	Apply
CO3	Apply engineering design process for the identified problem	Apply
CO4	Develop design specifications for the identified problem	Analyze
CO5	Develop working structure and concepts for the identified problem	Analyze
CO6	Provide embodiment and detail design for the identified problem	Analyze

Mapping with Programme Outcomes

COs	PO 1	PO 2	PO 3	PO 4	PO 5	PO 6	PO 7	PO 8	PO 9	PO 10	PO 11	PO 12	PSO 1	PSO 2	PSO 3
CO1	M	L	-	-	-	S	M	S	-	-	-	S	L	L	M
CO2	S	M	L	-	-	S	M	S	M	M	-	S	M	M	M
CO3	S	M	L	-	L	S	M	S	M	M	L	S	M	M	M
CO4	S	S	M	L	M	M	M	S	S	M	L	S	S	M	M
CO5	S	S	M	L	M	-	S	S	S	M	L	S	S	M	S
CO6	S	S	M	L	M	S	S	S	S	S	M	S	S	S	S

S- Strong; M-Medium; L-Low

Syllabus

Introduction: Engineering today, Requirements of engineering, Types of engineering, Engineering Solutions, Pillars of Engineering, Design Taxonomy, product, quality of product.

Engineering Design: Engineering Design Process, Types of Designs, A Simplified Iteration Model, Considerations of a Good Design, Description of Design Process, Design Review, Societal Considerations in Engineering Design, Problem Definition and Need Identification: Identifying Customer Needs, Customer Requirements, Establishing the Engineering Characteristics, Quality Function Deployment, product Design Specification. **Conceptual Design:** Steps, Abstracting to Identify the Essential Problems, Establishing Function Structures, Developing Working Structures and concepts, Examples. **Embodiment and Detail Designs:** Steps, Checklist, Basic Rules and Principles of Embodiment Design, Evaluating Embodiment Designs, Example of Embodiment Design, Detail Design, Design for Quality and minimum Cost.

Reference Books:

1. G.Pahl and W.Beitz (Translated by Ken Wallace et al.) 'Engineering Design: A Systematic Approach, Second Edition, Springer, 2005.
2. George E. Dieter and Linda C. Schmidt, "Engineering Design", Fourth Edition, McGraw Hill Higher Education, 2009.

3. Power Point Presentation material by Prof.D.K.Subramanian in the Workshop on Engineering Design at TCE, Madurai.
4. Foundation Skills in Integrated Product Development, NASSCOM, Edition 2015.

Assessment Pattern

Theory:

- Assessment Method: (Continuous Assessment Only)
- Test will be conducted along with CAT1 (Max.Marks: 50) - Converted to 20 Marks

Project Marks:

- Milestone 1: 10 Marks
- Milestone 2: 30 Marks
 - First Review and Viva (after 8 weeks – 40 Marks)
- Milestone 3: 15 Marks
- Milestone 4: 25 Marks
 - Second Review and Viva (after 12 Weeks – 40 Marks)

Project:

- Assessment Method: (Continuous Assessment Only)
- Milestones:
 - Milestone 1: Problem Description (3 weeks)
 - Milestone 2: Framework (4 weeks)
 - Functional Requirements
 - User Requirements
 - Performance Requirements
 - Specifications
 - Milestone 3: Preliminary Design (Conceptual) (3 weeks)
 - Cost Estimates
 - Milestone 4: Final Design (Conceptual Document) (2 weeks)

Course Designers:.

Dr. S.J. Thiruvengadam and Dr.S.Baskar

14EC470	ACTIVE CIRCUITS ANALYSIS AND SYNTHESIS	Category	L	T	P	Credit
		PC	2	0	1	3

Preamble

14EC470 is a study of Analog systems analysis and synthesis using active devices such as op-amp and IC555. The course aims at Circuit schematic development, Computer modelling, Simulation of analog systems and verifying their functionality using Hardware experiments. Experiments explore design of degenerative / regenerative feedback systems, filters, function generators, voltage controlled oscillator, phase locked loop (PLL), DC-DC converters and regulators. Students work through design activities, which include trouble shooting and documentation.

Prerequisite

14EC330 : Electronic Circuit Design

Course Outcomes

On the successful completion of the course, students will be able to

CO1	Understand the use of active devices as network elements.	Understand
CO2	Analyze the active network containing multi poles and operational amplifiers.	Analyze
CO3	Realization of active networks using driving point functions and transfer functions.	Create
CO4	Demonstrate the use of Phase Locked Loop and IC555 timers for frequency synthesis applications.	Apply
CO5	Demonstrate the use of IC regulators, DC-DC converters and Low dropout regulators for voltage regulation applications.	Apply
CO6	Methods to analyze the circuits containing active elements(Op-Amp) using SPICE simulator and ASLKV kit	Apply

Mapping with Programme Outcomes

COs	PO 1	PO 2	PO 3	PO 4	PO 5	PO 6	PO 7	PO 8	PO 9	PO 10	PO 11	PO 12	PSO 1	PSO 2	PSO 3
CO1	M	L	-	-	-	-	-	-	-	-	-	-	M	L	-
CO2	S	S	M	L	L	-	-	-	-	-	-	L	S	L	-
CO3	S	S	S	S	L	-	-	-	-	-	-	L	S	L	-
CO4	S	M	L	-	S	-	-	M	S	S	-	L	S	L	M
CO5	S	M	L	-	S	-	-	M	S	S	-	L	S	L	M
CO6	S	S	M	L	S	-	-	M	S	S	-	L	S	L	M

S- Strong; M-Medium; L-Low

Assessment Pattern

Bloom's Category	Continuous Assessment Tests			Terminal Examination
	1	2	3	
Remember	20	10	Practical	10
Understand	20	20		10
Apply	30	30		20
Analyse	30	20		30
Evaluate	0	0		0
Create	0	20		30

Course Level Assessment Questions**Course Outcome 1 (CO1):**

1. Mention the characteristics of an ideal op-amp
2. Calculate the maximum frequency for an op-amp with sine wave output voltage of 10 V peak and slew rate is 2 V/ μ s.
3. Draw the equivalent circuit of practical op-amp.
4. Explain in detail about Non – Inverting amplifier.

Course Outcome 2 (CO2):

1. Mention some of the linear applications of op-amps.
2. Draw the circuit diagram of the practical differentiator circuit.
3. State the important features of an instrumentation amplifier.
4. How is slew rate measured? Explain in detail with an example.
5. Design a low pass filter at cut off frequency of 15.9 kHz with a passband gain 1.5.
6. Sketch the amplitude and phase response of Butterworth filter.

Course Outcome 3 (CO3)

1. Describe the principle of operation of PLL.
2. Discuss about lock and capture range.
3. Design a Frequency multiplier using PLL.
4. Design a Frequency synthesizer using PLL.

Course Outcome 4 (CO4)

1. List the applications of Schmitt trigger.
2. Draw and explain the functional diagram of a 555 Timer.
3. How is an astable multivibrator connected into a pulse position modulator ?
4. Derive the expression of time delay of a monostable multivibrator.
5. Design a schmitt trigger using 555 timer and explain its operation.

Course Outcome 5 (CO5)

1. List the applications of Regulators.
2. Design a DC-DC converter using op-amp.
3. Design a LDO regulator using op-amp.

Concept Map

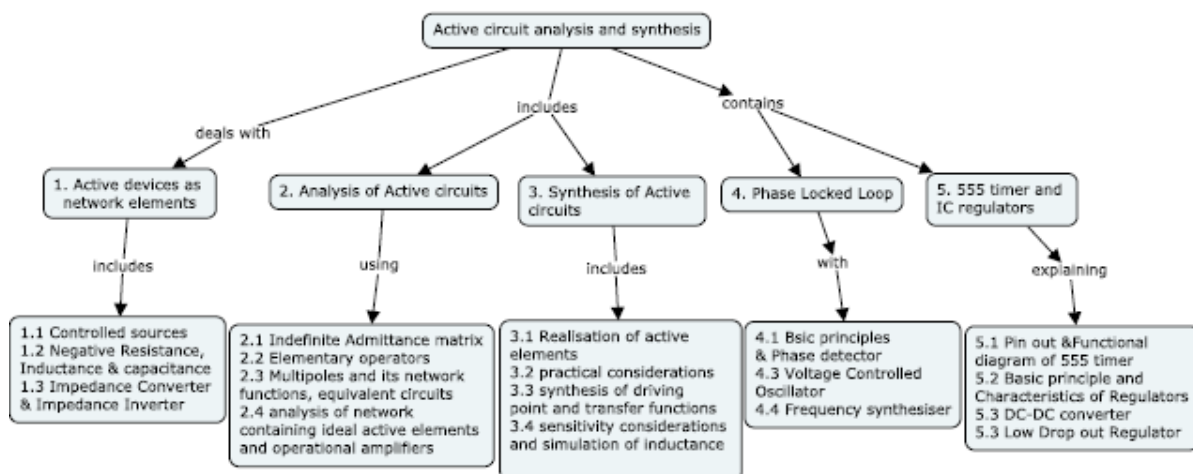

Syllabus

Active devices as Network elements: Controlled Sources, Negative Resistance (NR) Inductance and Capacitance, Impedance Converter (IC) and Impedance Inverter (II). **Analysis of Active circuits:** Indefinite admittance matrix, Elementary operators, classification of multipoles and its network functions, equivalent circuits, analysis of networks containing ideal active elements and operational amplifiers. **Synthesis of Active circuits:** Realisation of networks containing active elements (NR, NIC, Controlled sources, Op-Amps and Gytrators), Practical considerations, synthesis of driving point functions and transfer functions, Sensitivity considerations, simulation of inductance **Phase locked Loop:** Basic principles, phase detector, Voltage controlled oscillator (VCO), low pass filter, Frequency synthesizer. **555 timer:** Description of Pin out and functional Diagram. **IC Regulators:** Basic principles and Characteristics, DC-DC converter, Low Drop out Regulator.

Laboratory experiments:

- Simulation of Negative Resistance, Negative Impedance Converter, Negative inductance and capacitance.
- Study the AC and DC characteristics of Operational amplifier and its parameters.
- Design and implement the applications of Operational amplifier.
 - Voltage Follower
 - V to I and I to V converters
 - Arithmetic operations
 - Instrumentation Amplifier,
- Design and implementation of Analog filters.
- Study the characteristics of regenerative feedback amplifier with extension to design and implementation of Astable and Monostable multivibrators using Op-amp and NE555
- Design a function generator and convert it Voltage-Controlled Oscillator/ FM generator.
- Design and implementation of Automatic Gain Control (AGC).
- Design and implementation of Phase locked loop.
- Design and implementation of a DC-DC Converter.
- Design and implementation of a Low Dropout Regulator.

Text Book

- Adel S.Sedra, Kenneth C.Smith, and adapted by Arun N.Chandorkar, Microelectronic Circuits Theory and Applications, Prentice-Hall, 5th Edition, 2009.
- S. K. Mithra, Analysis And Synthesis of Linear Active Networks, John Wiley & Sons International, 1985.

3. D.Roy Choudhury, and Shail B.Jain, Linear Integrated Circuits, ,New Age International Publishers, Fourth Edition, 2012.

Reference Books

1. Ramakant A. Gayakwad, "OP-AMP and Linear ICs", 4th Edition, PHI, 2001.
2. Sergio Franco, "Design with Operational Amplifiers and Analog Integrated Circuits" 3rd Edition, Tata McGraw-Hill, 2011.
3. Robert F.Coughlin, Frederick F.Driscoll, "Operational Amplifiers and Linear Integrated Circuits", Sixth Edition, PHI, 2001.
4. G Daryanani, "Principles of Active Network Synthesis and Design" , John Wiley & Sons International, 1976.
5. William D.Stanley, "Operational Amplifiers with Linear Integrated Circuits", Pearson Education, 2004.
6. K.R.K. Rao, C.P. Ravikmar,"Analog System Lab Manua" , 2nd Edition, Texas Instruments, Wiley, 2012.

Course Contents and Lecture Schedule

Module No.	Topic	No. of Lectures
1.	Active devices as Network elements:	
1.1	Controlled Sources	2
1.2	Negative Resistance (NR) Inductance and Capacitance	1
1.3	Impedance Converter (IC) and Impedance Inverter (II)	2
2.	Analysis of Active circuits:	
2.1	Indefinite admittance matrix	1
2.2	Elementary operators	1
2.3	Classification of multipoles and its network functions, equivalent circuits	2
2.4	analysis of networks containing ideal active elements and operational amplifiers	2
3.	Synthesis of Active circuits:	
3.1	Realisation of networks containing active elements (NR, NIC, Controlled sources, Op-Amps and Gytrators)	2
3.2	Practical considerations	1
3.3	synthesis of driving point functions and transfer functions	2
3.4	Sensitivity considerations and simulation of inductance	1
4.	Phase locked Loop:	
4.1	Basic principles, Phase detector	1
4.2	Voltage controlled oscillator(VCO), Low pass filter	1
4.3	Frequency synthesizer.	1
5.	555 timer and IC Regulators	
5.1	Description of pin out and functional Diagram of 555 timer	1
5.2	Basic principles and Characteristics of regulators	1
5.3	DC-DC converter	1
5.4	Low Drop out Regulator	1
		24
	Total	48

Course Designers:

1.Dr.N.B.Balamurugan	nbbalamurugan@tce.edu
2.Mr.V.Vinoth Thyagarajan	vvkece@tce.edu
3.Dr. V.R.Venkatasubramani	venthiru@tce.edu

14EC480	MICROCONTROLLER LABORATORY	Category	L	T	P	Credit
		PC	0	0	1	1

Preamble

This course is designed to complement the course *14EC420 microcontroller*. The purpose of this course is to give hands on training to the students in understanding and practicing the embedded C programming concepts and algorithms. This will improve the embedded system design capability of the students.

Prerequisite

14EC420 Microcontroller

Course Outcomes

On the successful completion of the course, students will be able to

CO1	Write, compile, debug, link and execute C program for the given 8051 target board	Apply
CO2	Developing C code for accessing GPIO for interfacing switched and LEDs	Apply
CO3	Use different methods for accessing timers peripheral and serial peripherals in assembly and C programming	Apply
CO4	Design a system for temperature acquisition system for an intel Galileo board	Apply
CO5	Analyze the memory requirements and delay for the system by implementing the application in 8051 target board	Analyze

Mapping with Programme Outcomes

COs	PO 1	PO 2	PO 3	PO 4	PO 5	PO 6	PO 7	PO 8	PO 9	PO 10	PO 11	PO 12	PSO 1	PSO 2	PSO 3
CO1	S	M	L	-	S	-	-	L	M	L	-	-	M	-	-
CO2	S	M	L	-	S	-	-	L	M	L	-	-	M	-	-
CO3	S	M	L	-	S	-	-	L	M	L	-	-	M	-	-
CO4	S	M	L	-	S	-	-	L	M	L	-	-	M	-	-
CO5	S	S	M	-	S	-	-	M	L	L	-	-	S	-	-

S- Strong; M-Medium; L-Low

Syllabus

- Basic programs to understand the Keil IDE for 8051
 - Assembling, compiling and simulating the code
 - Break points and step by step execution of the code
 - Calculating the delay for the given clock frequency
- Basic sketch programs to understand the arduino Galileo IDE
 - Developing the sketch program for blinking the LEDs
 - Using built in functions for accessing switch and LEDs
- Developing an assembly program for accessing GPIO and Timer peripherals in 8051 boards
 - Blinking the LED by the defined rate in delay using timer
 - Using polling method read the status of switches
- Developing an assembly program for invoking interrupt in 8051 target board
 - Control the LEDs by the external interrupts
 - handling multiple interrupts
 - handling timer interrupt

5. Developing C programs for accessing ADC through GPIO ,timer peripherals and interrupts in 8051
 - a. Blinking the LED by the defined rate in delay using timer
 - b. Control the LEDs by the external interrupts
 - c. Access the ADC and display the send data to LEDs
6. Design a setup for a display system to display the data in 7 segment LED and LCD module
 - a. A number is incremented for the period of time and it should be shown in display
 - b. The stored alpha numeric string is displayed in LCD module
7. Design a setup for UART communication between 8051 target board and PC
 - a. The text stored in the 8051 program is send to PC
 - b. The text sent by PC is displayed in LCD module in 8051 target board
8. Design an analog data acquisition system on the 8051 target board
 - a. Using ADC, timer, interrupts and serial port
 - b. Using the analog sensors such as LDR, thermistor, LM35
9. Design a system for an temperature monitoring application in Intel Galileo
10. Design a system for servo motor control application in Intel Galileo
11. Design a system for stepper motor control application along with ultra sonic sensor in Intel Galileo
12. Design a mini project either in 8051 target board or intel Galileo

Course Designers:

Dr.K.Hariharan

Dr.L.R.Karlmarx

Mr.S.Parthasarathi

khh@tce.edu

lrkarlmarx@tce.edu

parthasarathi_s@tce.edu



14EC490	SIGNAL PROCESSING LABORATORY	Category	L	T	P	Credit
		PC	0	0	1	1

Preamble

This course is designed to complement the course 14EC340 *Signals and Systems* and 14EC440 *Signal Processing*. The purpose of this course is to give hands on training to the students in understanding the theory of signals and systems and practicing the algorithms used in digital signal processing. This will improve the understanding capability of the signal and system theory and simulation capability of the signal processing algorithms.

Prerequisite

14EC340 Signals and Systems

Course Outcomes

On the successful completion of the course, students will be able to

CO1	Understand the time and frequency domain representation of discrete time signals through simulation	Understand
CO2	Analyze the time and frequency domain response of discrete time systems through simulation	Analyze
CO3	Simulate a random sequence for the given distribution	Understand
CO4	Design FIR and IIR filter for the specification derived from the given problem and simulate the frequency response	Create
CO5	Analyze the effects of quantization error in the filter coefficients through simulation	Analyze

Mapping with Programme Outcomes

COs	PO 1	PO 2	PO 3	PO 4	PO 5	PO 6	PO 7	PO 8	PO 9	PO 10	PO 11	PO 12	PSO 1	PSO 2	PSO 3
CO1	S	M	L	-	S	-	-	-	M	M	-	L	S	M	M
CO2	S	S	M	L	S	-	-	-	M	M	-	L	S	S	M
CO3	S	M	L	-	S	-	-	-	M	M	-	L	S	M	M
CO4	S	M	L	-	S	-	-	-	M	M	-	L	S	M	M
CO5	S	S	M	L	S	-	-	-	M	M	-	L	S	S	M

S- Strong; M-Medium; L-Low

Syllabus

1. Sinusoidal Signals and Spectrum.
2. Fourier Series Representation of Periodic signals
3. Time and Frequency Response of LTI Systems
4. Sampling
5. Spectral analysis
6. Experiments on Random variables and Processes
7. Filter Design based on Pole zero placement
8. FIR Filter Design and Analysis
9. IIR Filter Design and Analysis
10. Effect of Quantization

Course Designers:

- | | |
|-------------------------|--|
| 1. Dr.S.J.Thiruvengadam | sjtece@tce.edu |
| 2. Dr.M.N.Suresh | mNSECE@tce.edu |
| 3. Dr.K.Rajeswari | rajeswari@tce.edu |
| 4. Dr.G.Ananthi | gananthi@tce.edu |

14EC4C2	CAPSTONE I	Category	L	T	P	Credit
		PC	0	0	2	2

Preamble

The purpose of this course is to apply the concept of mathematics, science and engineering fundamentals and an engineering specialization to solve complex engineering problems.

Prerequisite

Nil

Course Outcomes

On the successful completion of the course, students will be able to

CO1	Explain the basic concepts of core engineering courses in the programme	Understand
CO2	Explain the importance of the mathematics and science courses in the programme and its correlation with the core engineering courses	Understand
CO3	Solve basic problems in core engineering courses of the programme	Apply
CO4	Solve complex problems by applying the concepts of core engineering, mathematics and science courses	Apply
CO5	Analyze complex problems in core engineering courses of the programme	Analyze

Mapping with Programme Outcomes

COs	PO 1	PO 2	PO 3	PO 4	PO 5	PO 6	PO 7	PO 8	PO 9	PO 10	PO 11	PO 12	PSO 1	PSO 2	PSO 3
CO1	M	L	-	-	-	-	-	-	-	-	-	L	L	-	-
CO2	M	L	-	-	-	-	-	-	-	-	-	L	L	-	-
CO3	S	M	L	L	L	-	-	-	M	-	-	L	M	L	-
CO4	S	M	L	L	M	-	-	-	M	-	-	L	M	L	-
CO5	S	S	M	L	S	-	-	-	M	-	-	L	M	L	-

S- Strong; M-Medium; L-Low

Syllabus

Networks, Signals and Systems: Network solution methods: nodal and mesh analysis; Network theorems: superposition, Thevenin and Norton's, maximum power transfer; Wye- Delta transformation; Steady state sinusoidal analysis using phasors; Time domain analysis of simple linear circuits; Solution of network equations using Laplace transform; Frequency domain analysis of RLC circuits; Linear 2- port network parameters: driving point and transfer functions; State equations for networks. Continuous-time signals: Fourier series and Fourier transform representations, sampling theorem and applications; Discrete-time signals: discrete-time Fourier transform (DTFT), DFT, FFT, Z-transform, interpolation of discrete-time signals; LTI systems: definition and properties, causality, stability, impulse response, convolution, poles and zeros, parallel and cascade structure, frequency response, group delay, phase delay, digital filter design techniques.

Electronic Devices: Energy bands in intrinsic and extrinsic silicon; Carrier transport: diffusion and drift current, mobility and resistivity; Generation and recombination of carriers; Poisson and continuity equations; P-N junction, Zener diode, BJT, MOS capacitor, MOSFET, LED and photo diode.

Analog Circuits: Small signal equivalent circuits of diodes, BJTs and MOSFETs; Simple diode circuits: clipping, clamping and rectifiers; Single-stage BJT and MOSFET amplifiers: biasing, bias stability, mid-frequency small signal analysis and frequency response; BJT and

MOSFET amplifiers: multi-stage, differential, feedback, power and operational; Simple op-amp circuits; Active filters; Sinusoidal oscillators: criterion for oscillation, single-transistor and opamp configurations; Function generators, wave-shaping circuits and 555 timers; Voltage reference circuits; Power supplies: ripple removal and regulation.

Digital Circuits: Number systems; Combinatorial circuits: Boolean algebra, minimization of functions using Boolean identities and Karnaugh map, logic gates and their static CMOS implementations, arithmetic circuits, code converters, multiplexers, decoders and PLAs; Sequential circuits: latches and flip-flops, counters, shift-registers and finite state machines; Data converters: sample and hold circuits, ADCs and DACs; Semiconductor memories: ROM, SRAM, DRAM; 8-bit microprocessor (8085): architecture, programming, memory and I/O interfacing.

Electromagnetics: Electrostatics; Maxwell's equations: differential and integral forms and their interpretation, boundary conditions, wave equation, Poynting vector; Plane waves and properties: reflection and refraction, polarization, phase and group velocity, propagation through various media, skin depth; Transmission lines: equations, characteristic impedance, impedance matching, impedance transformation, S-parameters, Smith chart.

Assessment Pattern

(Common to B.E./B.Tech Programmes)

Continuous Assessment Test 1 (50 Marks):

Duration: 90 Minutes

Objective Type Questions : 40 marks
Fill up the blanks : 10 marks

Continuous Assessment Test 2 (50 Marks):

Duration: 90 Minutes

Objective Type Questions : 40 marks
Fill up the blanks : 10 marks

Continuous Assessment Test 3 - Comprehensive (50 Marks):

Objective Type Questions : 40 marks
Fill up the blanks : 10 marks

Test	Marks Obtained
Test1	50 Marks (Max)
Test 2	50 Marks (Max)
Test 3	50 Marks (Max)

Best two, among the three test Continuous Assessment Tests, shall be considered

Course Designers:.

Dr.P.G.S.Velmurugan, Dr.V.R.Venkatasubramani and Dr.S.J. Thiruvengadam

CURRICULUM AND DETAILED SYLLABI

FOR

FIFTH SEMESTER

B.E. DEGREE PROGRAMME

IN



ELECTRONICS AND COMMUNICATION ENGINEERING

FOR THE STUDENTS ADMITTED IN THE

ACADEMIC YEAR 2014-15 ONWARDS

**DEPARTMENT OF ELECTRONICS AND COMMUNICATION
ENGINEERING**

THIAGARAJAR COLLEGE OF ENGINEERING

(A Government Aided ISO 9001:2008 certified Autonomous Institution affiliated to Anna University)

MADURAI – 625 015, TAMILNADU

Phone: 0452 – 2482240, 41

Fax: 0452 2483427

Web: www.tce.edu

14EC510	DATA COMMUNICATION NETWORKS	Category	L	T	P	Credit
		PC	3	0	0	3

Preamble

The objectives of this course are to provide in-depth understanding of the underlying concepts of computer networks, extend the students' knowledge in the areas of multiple access techniques, network protocols, the upper layers of the OSI model and treat certain key related areas such as performance, internetworking and emerging trends in networking technologies

Prerequisite

NIL

Course Outcomes

On the successful completion of the course, students will be able to

CO1. Understand the details and functionality of layered network architecture	Understand
CO2. Identify different networking components and their respective roles in a communication system	Understand
CO3. Design an enterprise network employing the common LAN technologies and be able to evaluate the advantages and disadvantages	Apply
CO4. Design, calculate and apply subnet masks and addresses and identify routing mechanisms to fulfil networking requirements	Analyze
CO5. Analyze the features and operations of various application layer protocols such as HTTP, DNS and SMTP	Analyze
CO6. Identify the key factors to improve the performance of data communication networks	Understand

Mapping with Programme Outcomes

COs	PO 1	PO 2	PO 3	PO 4	PO 5	PO 6	PO 7	PO 8	PO 9	PO 10	PO 11	PO 12	PSO 1	PSO 2	PSO 3
CO1	M	L	-	-	-	-	-	L	M	L	-	L	L	-	L
CO2	S	S	-	-	M	-	-	L	-	M	-	L	S	-	L
CO3	S	S	M	-	-	-	-	M	M	L	L	-	S	L	L
CO4	S	S	M	-	-	-	-	M	M	L	L	-	S	L	L
CO5	S	S	L	-	-	-	-	L	-	M	L	L	M	L	L
CO6	S	M	L	-	L	-	-	-	M	L	-	L	S	-	L

S- Strong; M-Medium; L-Low

Assessment Pattern

Bloom's Category	Continuous Assessment Tests			Terminal Examination
	1	2	3	
Remember	20	0	0	0
Understand	20	20	20	30
Apply	60	60	60	40
Analyse	0	20	20	30
Evaluate	0	0	0	0
Create	0	0	0	0

Course Level Assessment Questions**Course Outcome 1(CO1):**

1. Mention important benefits of computer network?
2. What are the key functions of data link layer?

3. Identify the components of data communication systems.
4. What do you mean by Protocol?
5. Describe and compare the network architectures of OSI model and TCP/IP Model.

Course Outcome 2 (CO2):

1. What are the advantages of having a switch rather than a hub to interconnect several machines?
2. What is the use of Bridge?
3. Why spanning tree topology is necessary for routing using a bridge?
4. Describe how spanning tree algorithm is used in configuring a network using bridge.
6. Compare the roles of switch and router.
7. Identify the components of router.

Course Outcome 3 (CO3)

1. If you want to transmit the message 1011001001001011 and protect it from errors using the CRC 8 polynomial x^8+x^2+x+1 , use polynomial long division to determine the message that should be transmitted.
2. Identify the key issues related to MAC techniques?
3. Classify various contention based techniques such as ALHOA, CSMA, CSMA/CD and CSMA/CA?

Course Outcome 4 (CO4):

1. Consider a corporate network with the given IP Address 120.34.0.0. Create and configure eight sub networks with 40 Hosts attached to each subnetwork. IP currently uses 32-bit addresses. If we could redesign IP to use the 6-byte MAC address instead of the 32-bit address, would we be able to eliminate the need for ARP? Explain why or why not?
2. An organization has a class-c network 200.1.1 and wants to form subnet for four departments, with hosts as follows: Dept. A - 72 hosts, Dept. B - 35hosts, Dept. C - 20 hosts, Dept. D - 18 hosts. There are 145 hosts in all. Give a possible arrangement of subnet masks to make this possible. Suggest what the organization might do if department D grows to 34 hosts.
3. Explain how route optimization is done using CIDR.

Course Outcome 5 (CO5):

1. Consider a point to point link 50 Km. in length. At what bandwidth would propagation delay equal transmit delay for 100 bytes packet? What about 512 byte packets?
2. Suppose a 128 Kbps pt. to pt. link is set up between earth and rover on mars. The distance from earth to mars is approximately 55 Gm and data travels over the link at the speed of light.
 - a. Calculate minimum RTT for link
 - b. Calculate the delay bandwidth product for the link.

Course Outcome 6 (CO6):

1. Compute the propagation delay when ARQ algorithm is running over 20-Km point to point fiber link. Assume the speed of light is 2×10^8 m/s in fiber.
2. Draw a timeline diagram for the sliding window algorithm with $SWS = RWS = 3$ frames, for the following two situations. Use a timeout interval of about 2 XRTT (a) Frame 4 is lost and (b) Frames 4-6 are lost.
3. Consider the use of 10 K-bit size frames on a 10 Mbps satellite channel with 270 ms delay. What is the link utilization for stop-and-wait ARQ technique assuming that $P = 10^{-3}$?

Concept Map

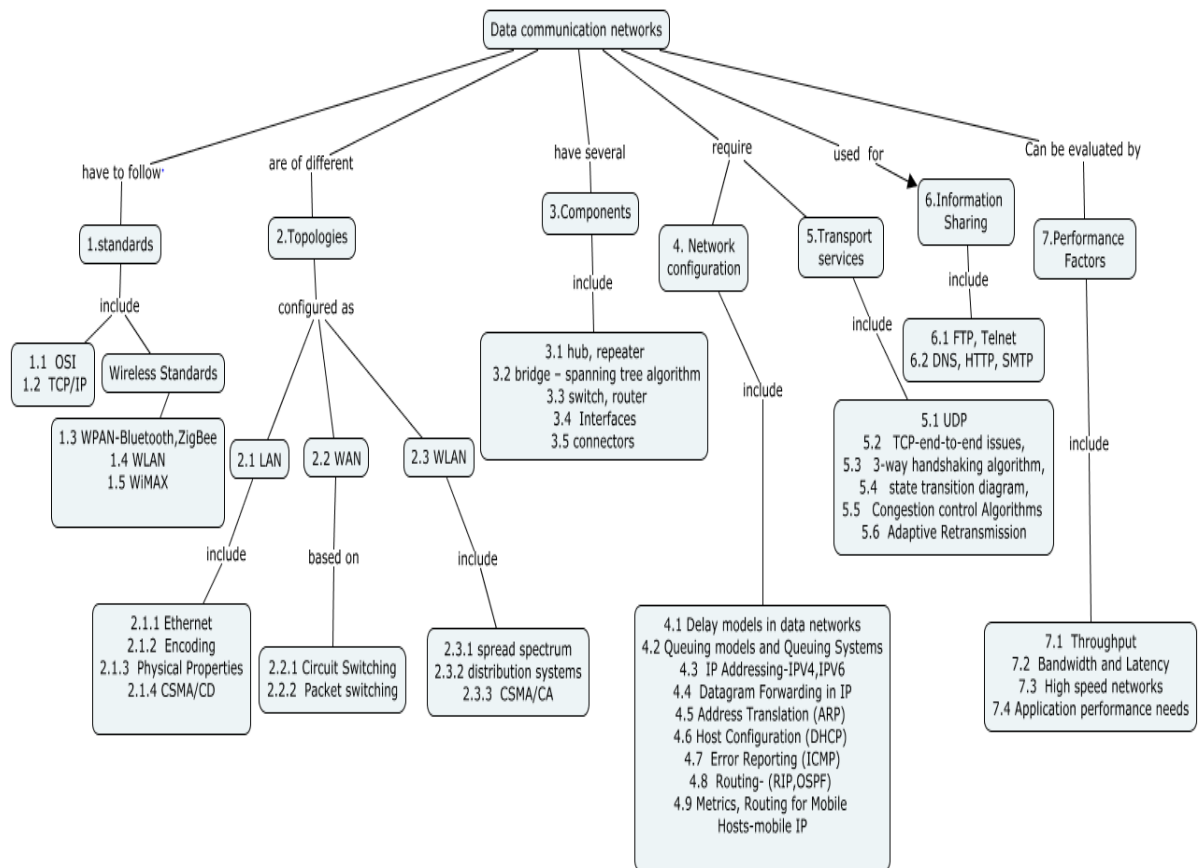

Syllabus

Networking standards: OSI model, TCP/IP model .Wireless standard: WPAN - Bluetooth, Zigbee (IEEE802.15.4), Adhoc and Sensor Networks.

Topologies: Bus, star, Ring, Mesh. LAN – Ethernet - Encoding, Physical properties, CSMA/CD(IEEE 802.3). WAN – Circuit switching, Packet switching WLAN – spread spectrum, distribution systems, CSMA/CA(IEEE 802.11n). Flow control – stop and wait protocol, sliding window protocol Error control – CRC, checksum.

Networking Components: Internetworking devices – hub, repeater, bridge – spanning tree algorithm, switch, router Interfaces and connectors.

Network Configuration: Delay models in data networks - Queuing models and Queuing systems,(M/M/1). IP Addressing-IPv4, Datagram Forwarding in IP, Address Translation: Address Resolution Protocol (ARP), Host Configuration: Dynamic Host Configuration Protocol (DHCP), Error Reporting: Internet Control Message Protocol (ICMP), .Routing-Network as a Graph, Distance Vector: Routing Information Protocol (RIP), Link State: Open Shortest Path Find (OSPF), Metrics, Routing for Mobile Hosts. Global Internet - subnetting, classless routing, IPv6, Mobile IP.

Transfer Services: UDP, TCP-end-to-end issues, 3-way handshaking algorithm, state transition diagram, Congestion control Algorithms – Adaptive Retransmission.

Information Sharing: FTP, Telnet, DNS, HTTP and SMTP.

Performance factors – Throughput, Bandwidth and Latency, High speed networks, Application performance needs.

Text Books

1. Larry L.Peterson and Bruce S.Davie, “Computer Networks: A Systems Approach”, Morgan Kaufmann Publishers., San Francisco, Fourth Edition, 2007.

Reference Books:

1. J.F. Kurose & K.W. Ross, "Computer Networking- A top down approach featuring the internet", Pearson, 2nd edition, 2012.
2. Andrew S. Tanenbaum, "Computer Networks", PHI, Fourth Edition, 2011.
3. Behrouz A. Forouzan, "Data Communication and Networking", Tata McGraw-Hill, 2013.
4. Dimitri Bertsekas and Robert Gallager, "Data Networks" Prentice hall of India Pvt. Ltd., Second edition, 1994.
5. <http://www.tcpipguide.com/free/index.html>

Course Contents and Lecture Schedule

Module No.	Topic	No. of Lectures
1	Networking Standards	
1.1	OSI model	1
1.2	TCP/IP model	1
1.3	Wireless standard: WPAN – Bluetooth. Zigbee (IEEE802.15.4), Introduction to adhoc and sensor Network	2
2	Topologies	
2.1	Bus, Star, Ring, Mesh	1
2.2	LAN-Ethernet-Physical properties, CSMA/CD	2
2.3	WAN - Circuit Switching and Packet Switching	1
2.4	WLAN - Spread Spectrum, Distribution Systems, CSMA/CA	1
2.5	Flow control - Stop and wait protocol, Sliding window protocol	1
2.6	Error control - CRC, Checksum	1
3	Networking components	
3.1	Internetworking devices-hub, repeater, bridge, switch, Spanning Tree algorithm	2
3.2	Interfaces	1
3.3	Connectors	1
4	Network Configuration	
4.1	Delay models in data networks-Queuing models and queuing system-M/M/1	2
4.2	IP Addressing-IPv4	1
4.3	Datagram forwarding in IP	1
4.4	Address Translation (ARP)	1
4.5	Host Configuration (DHCP)	1
4.6	Error reporting (ICMP)	1
4.7	Virtual Networks and tunnels	1
4.8	IPv6	1
5	Routing	
5.1	Network as a graph distance vector	1
5.2	Link State (OSPF)	1
5.3	Metrics routing for mobile hosts	1
5.4	Global internet – Subnetting, classless routing, Mobile IP	2
6	Transfer Services	
6.1	UDP	1
6.2	TCP, End to end issues	1
6.3	3 way Handshaking Algorithm	1
6.4	State transition diagram	1
6.5	Congestion control algorithms – Adaptive retransmission	1
7	Information Sharing	

7.1	FTP, Telnet	1
7.2	DNS	1
7.3	HTTP	1
7.4	SMTP	1
8	Performance Factors	
8.1	Throughput	1
8.2	Bandwidth and Latency	1
8.3	High speed networks	1
8.4	Application performance needs	1

Course Designers:

1	Dr.M.S.K.Manikandan	manimsk@tce.edu
2	Mrs. E. Murugavalli	murugavalli@tce.edu



14EC520	DIGITAL CMOS SYSTEMS	Category	L	T	P	Credit
		PC	3	0	0	3

Preamble

The course aims at understanding the basic concepts of Digital CMOS VLSI circuit by studying logic design, physical structure and fabrication of semiconductor devices and how they are combined to build systems for efficient data processing.

Prerequisite

14EC330 : Electronics Circuit Design

Course Outcomes

On the successful completion of the course, students will be able to

CO1	Understand the design flow and fabrication of CMOS Integrated Circuits	Understand
CO2	Construct the complex logic circuits with MOSFETs	Apply
CO3	Examine the electrical characteristics and electronic aspects of CMOS logic.	Apply
CO4	Classify the CMOS Logic Families	Analyze
CO5	Construct the VLSI system components.	Analyze

Mapping with Programme Outcomes

COs	PO 1	PO 2	PO 3	PO 4	PO 5	PO 6	PO 7	PO 8	PO 9	PO 10	PO 11	PO 12	PSO 1	PSO 2	PSO 3
CO1	M	-	-	-	-	-	-	-	-	-	-	-	L	-	-
CO2	S	M	M	L	M	-	-	-	-	-	-	-	M	-	-
CO3	S	M	L	L	-	-	-	-	-	-	-	-	M	-	-
CO4	S	S	L	L	M	-	-	-	-	-	-	-	M	L	-
CO5	S	S	M	M	S	-	-	-	M	M	-	L	S	L	-

S- Strong; M-Medium; L-Low

Assessment Pattern

Bloom's category	Continuous Assessment Tests			End Semester Examinations
	1	2	3	
Remember	30	20	10	10
Understand	30	20	10	10
Apply	40	40	40	40
Analyze	0	20	40	40
Evaluate	0	0	0	0
Create	0	0	0	0

Course Level Assessment Questions**Course Outcome 1 (CO1):**

1. What is the difference between Enhancement and depletion mode transistors?
2. What do you mean by body effect?
3. What do you understand by Transient analysis?
4. What is meant by one hot encoding?
5. Discuss in detail about any three second order effects.

Course Outcome 2 (CO2):

1. An AND-OR logic is described by the schematic.
 - a. Construct the nFET array using the logic diagram.

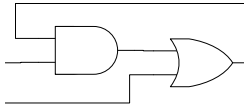

2. Design a CMOS logic gate circuit the implements the function $F = (a+b.c+a.b.c)'$ using series-parallel logic. The objective is to minimize the transistor count.
3. Design a 4:1 MUX using three 2:1 TG multiplexors.
4. Using transmission gates, design a 2:1 MUX circuit.
5. Consider the OAI Logic Function $g = (a+b).(c+d).e$. Design the CMOS Logic gate and then construct a basic layout for the circuit.
6. Consider the logic function $g = (a.b.c + d)'$. Design a CMOS logic gate for this function.

Course Outcome 3(CO3):

1. Construct the RC switch Model for the FET layout specifications. Assume a power supply voltage of 3 V.

$$L' = 0.5 \mu\text{m}$$

$$V_{\text{ton}} = 0.6 \text{ v}$$

$$C_{\text{ox}} = 2.70 \times 10^{-15} \text{ F}/\mu\text{m}^2$$

$$C_{\text{jsw}} = 0.24 \times 10^{-15} \text{ F}/\mu\text{m}^2$$

$$L_0 = 0.05 \mu\text{m}$$

$$k'n = 150 \mu\text{A}/\text{V}^2$$

$$C_j = 0.86 \times 10^{-15} \text{ F}/\mu\text{m}^2$$

$$X = 2 \text{ microns}, W = 6 \text{ microns}$$

2. An inverter uses FETs with $b_n = 2.1 \text{ mA}/\text{V}^2$ and $b_p = 1.8 \text{ mA}/\text{V}^2$. The threshold voltages are given as $V_{\text{tn}} = 0.6 \text{ V}$ and $V_{\text{tp}} = -0.7 \text{ V}$ and the power supply has a value of 5V. The parasitic capacitance at the output node is $C_{\text{out}} = 74 \times 10^{-15} \text{ F}$.
 - Find the mid-point Voltage V_m and values of R_n and R_p .
 - Calculate the rise time and fall time when $C_L = 0$
 - Calculate the rise time and fall time when $C_L = 115 \times 10^{-15} \text{ F}$
 - Plot t_r and t_f as functions of C_L .
3. A interconnect has the geometry with $T_{\text{ox}} = 0.9 \mu\text{m}$, $w = 0.35 \mu\text{m}$ and $t = 1.10 \mu\text{m}$. The interconnect line has a sheet resistance of $R_s = 0.04 \text{ ohms}$.
 - Find the value of 'c' predicted by the empirical expression that includes fringing.
 - Find the values of R_{line} and C_{line} if the line is 48um long.
 - Construct an $m=7$ RC ladder equivalent for the line, then use the model to determine time constant.

Course Outcome 4 (CO4):

1. Draw the small signal model for a MOS Transistor and derive the expression for g_m, g_{ds} .
2. Derive the expression for Rise time of CMOS Inverter
3. Derive the Basic DC Equations for the three modes of operations of CMOS inverter.
4. Derive the expression for Mid point voltage for CMOS inverter using DC Characteristics.
5. Derive the expression for CMOS Capacitance.
6. Consider an nFET chain shown in figure below. This represents the portion NAND3 gate. The output capacitance has a value of $C_{\text{out}} = 130 \text{ fF}$ while the internal values are $C_1 = C_2$

36fF. The transistors are identical with $\beta_n = 2.0 \text{ mA/V}^2$ in a process where $V_{DD}=3.3\text{V}$ and $V_{Tn} = 0.70\text{V}$.

- Find the discharge time constant for $C_{out}=130\text{fF}$ using Elmore formula for LADDER RC network.
- Find the time constant if ignore C_1 and C_2 .what is the percentage error introduced if we do not include the internal capacitors.

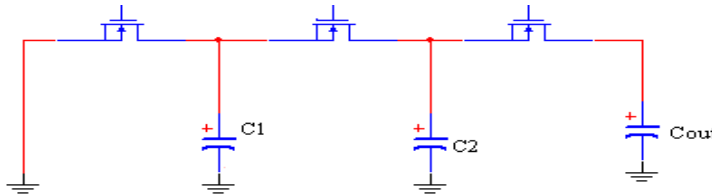

Course Outcome 5 (CO5):

- Design a NAND3 gate using an 8:1 MUX.
- Design a CMOS logic gate circuit the implements the function $F = (a+b.c+a.b.c)'$ using series-parallel logic. The objective is to minimize the transistor count.
- Using transmission gates, design a 2:1 MUX circuit.
- Consider the OAI Logic Function $g = (a+b).(c+d).e$. Design the CMOS Logic gate and then construct a basic layout for the circuit.
- Draw the Pseudo-nmos circuit for the functions
 - $F = (a+(c.[x+(y.z)]))'$
 - $h = ((a+b+c).x + y.z)'$
- Design a 2/4 active high decoder using only transmission gates in the main logic paths.

Concept Map

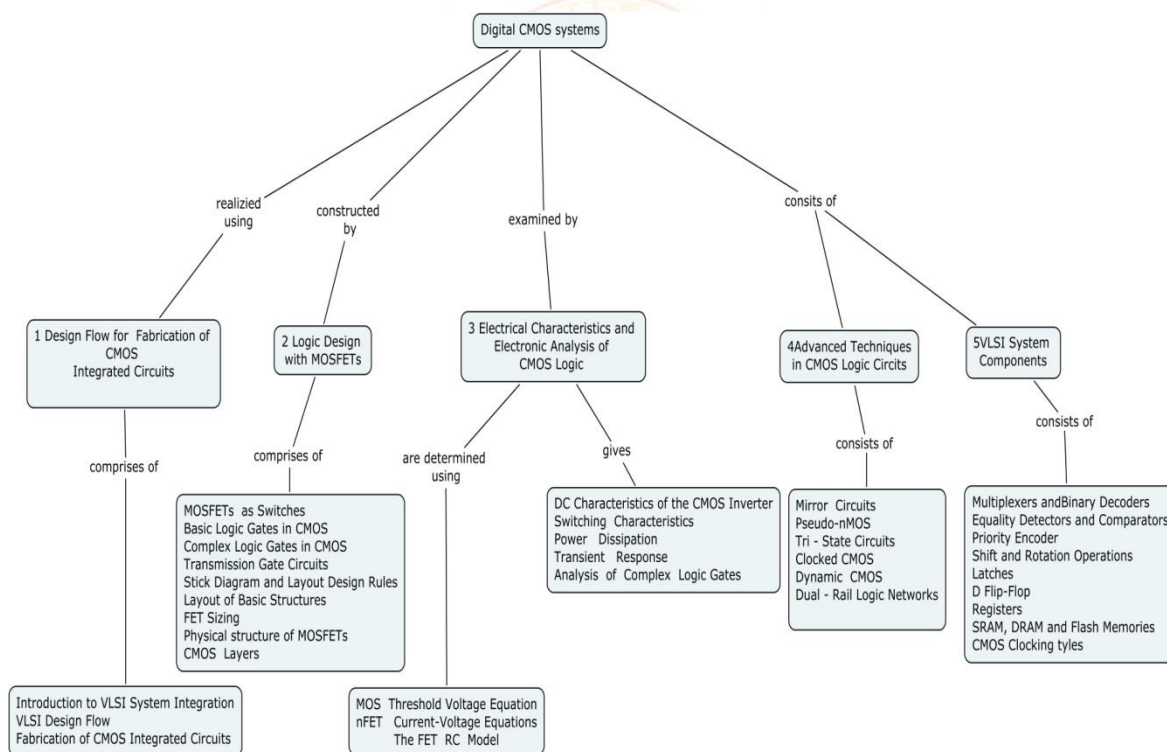

Syllabus

Design Flow for Fabrication of CMOS Integrated Circuits: VLSI System Integration, VLSI Design Flow, Fabrication of CMOS Integrated Circuits.

Logic Design With MOSFETs: MOSFETs as Switches, Basic Logic Gates in CMOS, Complex Logic Gates in CMOS, Transmission Gate Circuits, Stick Diagram and Layout Design Rules, Layout of Basic Structures, FET sizing, Physical structure of MOSFETs, CMOS Layers.

Electrical Characteristics and Electronic Analysis of CMOS Logic: MOS Threshold Voltage Equation, nFET Current-Voltage Equations, The FET RC Model, DC Characteristics of the CMOS Inverter, Switching Characteristics, Power Dissipation, Transient Response, Analysis of Complex Logic Gates.

CMOS Logic Families: Mirror Circuits, Pseudo- nMOS, Tri - State Circuits, Clocked CMOS, Dynamic CMOS and Dual Rail Logic Networks.

VLSI System Components: Transistor Level Realization - Multiplexors, Binary Decoders, Equality Detector and Comparators, Priority Encoders, Latches, D Flip-Flop, Registers, SRAM, DRAM and Flash Memories, CMOS Clocking Styles.

Text Book:

1. Uyemura, John P, "Introduction to VLSI Circuits and Systems". Wiley & Sons, 8th Reprint 2009.

Reference Books:

1. N. Weste and K. Eshraghian, "Principles of CMOS VLSI Design", Second Edition, Addison-Wesley, 1993.
2. Jan M. Rabaey, "Digital Integrated Circuits: A Design Perspective", Prentice Hall, Second Edition, 2006.
3. R. Jacob Baker, "CMOS: Circuit Design, Layout, and Simulation", Wiley-IEEE, Revised Second Edition, 2008.
4. Pucknell, "Basic VLSI Design", Prentice Hall, 1995.
5. Wayne Wolf, "Modern VLSI Design: System on Chip", Pearson Education, 2002.
6. MIT Open courseware: <http://ocw.mit.edu/courses/electrical-engineering-and-computer-science/6-374-analysis-and-design-of-digital-integrated-circuits/>.
7. <http://nptel.ac.in/courses>

Course Contents and Lecture Schedule

Module No	Topic	No.of Lectures
1	Design Flow for Fabrication of CMOS Integrated Circuits	
1.1	Introduction to VLSI System Integration	1
1.2	VLSI Design Flow	1
1.3	Fabrication of CMOS Integrated Circuits.	2
2	Logic Design using CMOS	
2.1	MOSFETs as Switches	1
2.2	Basic Logic Gates in CMOS	1
2.3	Complex Logic Gates in CMOS	2
2.4	Transmission Gate Circuits	1
2.5	Stick Diagram and Layout Design Rules	1
2.6	Layout of Basic Structures	1
2.7	FET sizing	1
2.8	Physical structure of MOSFETs	1
2.9	CMOS Layers	1
	Assignment I: Complex Logic Gates design using EDA Tools	

3	Electrical Characteristics and Electronic Analysis of CMOS Logic:	
3.1	MOS Threshold Voltage Equation	1
3.2	nFET Current-Voltage Equations	1
3.3	The FET RC Model	1
3.4	DC Characteristics of the CMOS Inverter.	1
3.5	Switching Characteristics	1
3.6	Power Dissipation	1
3.7	Transient Response	1
3.8	Analysis of Complex Logic Gates	1
	Assignment II: Problems in AC & DC characteristics of CMOS Logic.	
4	CMOS Logic Families	
4.1	Mirror Circuits	1
4.2	Pseudo-nMOS	0.5
4.3	Tri - State Circuits	0.5
4.4	Clocked CMOS	1
4.5	Dynamic CMOS	1
4.6	Dual - Rail Logic Networks	1
5	VLSI System Components	
5.1	Transistor Level Realization - Multiplexers and Binary Decoder	1
5.2	Equality Detectors and Comparators	1
5.3	Priority Encoder and Shift /Rotation Operations	1
5.4	Latches and D Flip-Flop	1
5.5	Registers	1
5.6	SRAM, DRAM and Flash Memories	2
5.7	CMOS Clocking Styles	1
	Assignment III: Transistor Level realization of Components using SPICE Tools.	

Course Designers:

1.	Dr.S.Rajaram	rajaram_siva@tce.edu
2.	Dr.N.B.Balamurugan	nbb@tce.edu
3.	Dr.D.Gracia Nirmala Rani	gracia@tce.edu

15EC531	RF ACTIVE CIRCUITS	Category	L	T	P	Credit
		PC	3	0	0	3

Preamble

This course aims to provide students with the technological skills needed in understanding the behaviour of two wire line, planar transmission lines and the design of RF passive circuits.

Prerequisite

15EC430 RF Transmission Lines and Passive Circuits (or)15EC431 RF Transmission Lines and Passive Circuits

Course Outcomes

On the successful completion of the course, students will be able to

CO1. Evaluate matching networks using smith chart.	Evaluate
CO2. Design of Low Power RF Amplifiers	Apply
CO3. Design of one port RF Oscillators	Apply
CO4. Design of Single Ended Mixers	Apply
CO5. Calculate RF System level Parameters- Noise & Power budget for a Wireless RF front end system.	Understand

Mapping with Programme Outcomes

COs	PO 1	PO 2	PO 3	PO 4	PO 5	PO 6	PO 7	PO 8	PO 9	PO 10	PO 11	PO 12	PSO 1	PSO 2	PSO 3
CO1	S	S	S	L	M	-	-	L	-	-	L	S	M	L	
CO2	S	M	L	-	M	-	-	-	L	-	-	L	M	M	L
CO3	S	M	L	-	M	-	-	-	L	-	-	L	M	M	L
CO4	S	M	L	-	M	-	-	-	-	-	-	L	M	M	L
CO5	M	L	-	-	-	-	-	-	-	-	-	-	L	-	L

S- Strong; M-Medium; L-Low

Assessment Pattern

Bloom's Category	Continuous Assessment Tests			Terminal Examination
	1	2	3	
Remember	0	0	0	0
Understand	0	20	20	20
Apply	80	80	60	60
Analyse	0	0	0	0
Evaluate	20	0	20	20
Create	0	0	0	0

Course Level Assessment Questions**Course Outcome 1 (CO1):**

1. What are the factors needed to develop a matching network? What is a stub?
2. What are the drawbacks of L section matching? Why double stubs are preferred?
3. For a load impedance $Z_L = 15 + j10 \Omega$, design two single stub shunt tuning networks to match this load to a 50Ω line. Assume the load is matched at 2 GHz and the load consists of a resistor and inductor in series.
4. Design a double stub shunt tuner to match a load impedance $Z_L = 60 - j80 \Omega$ to a 50Ω line. The stubs are to be short circuited stubs and are spaced $\lambda/8$ apart. Assume that this load consists of a series resistor and capacitor and the match frequency is 2 GHz.
5. Design a lumped element matching network at 1 GHz that would transform $Z_L = 0.2 + j0.2 \Omega$ into a 50Ω transmission line.

6. Using a single series open stub, design a matching network that will transform a load impedance $Z_L=100+j80\Omega$ to a 50Ω feed transmission line.

Course Outcome 2 (CO2):

- The S parameters for the HP HFET-102 GaAs FET at 2 GHz with the bias voltage $V_{gs}=0$ are given as follows:
 $S_{11}=0.894 \angle -60.6^\circ$, $S_{21}=3.122 \angle 123.6^\circ$, $S_{12}=0.020 \angle 62.4^\circ$, $S_{22}=0.781 \angle -27.6^\circ$.
 Determine the stability of this transistor by calculating K and $|\Delta|$ and plot the stability circles.
- An amplifier uses a transistor having the following S parameters ($Z_0=50\Omega$)
 $S_{11}=0.61 \angle -170^\circ$, $S_{12}=0.06 \angle 70^\circ$, $S_{21}=2.3 \angle 80^\circ$, $S_{22}=0.72 \angle -25^\circ$. The input of the transistor is connected to a source with $V_s=2$ V(peak) and $Z_s=25\Omega$. and the output of the transistor is connected to a load of $Z_L=100\Omega$. What is the power gain, the available power gain, the transducer power gain and the unilateral transducer power gain.
- A GaAs FET has the following scattering and noise parameters at 6 GHz ($Z_0=50\Omega$):
 $S_{11}=0.6 \angle -60^\circ$, $S_{12}=0$, $S_{21}=2.0 \angle 81^\circ$, $S_{22}=0.7 \angle -60^\circ$, $F_{min}=2$ dB, $\Gamma_{opt}=0.62 \angle 100^\circ$ and $R_N=20\Omega$. Design an amplifier to have a gain of 6 dB, and the minimum noise figure possible with this gain. Use open circuited shunt stubs in the matching sections.
- Design an amplifier for maximum gain at 4 GHz using single stub matching sections. The GaAs FET has the following specifications:
 $S_{11}=0.72 \angle -116^\circ$, $S_{21}=2.60 \angle 76^\circ$, $S_{12}=0.03 \angle 57^\circ$, $S_{22}=0.73 \angle -54^\circ$, $T_s=0.872 \angle 123^\circ$, $T_L=0.876 \angle 61^\circ$, $Z_0=50$ ohms.

Course Outcome 3 (CO3):

- One oscillator has a Q of 5, another a Q of 50. Which oscillator reaches steady-state conditions first? Which oscillator can be quenched more quickly? Are these results intuitive? Can you think a mechanical system that behaves the same way?

Course Outcome 4 (CO4):

- A double-sideband signal of the form
 $v_{RF}(t) = V_{RF} [\cos(\omega_{LO} - \omega_{IF})t + \cos(\omega_{LO} + \omega_{IF})t]$ is applied to a mixer with an LO voltage given as $v_{LO}(t) = V_{LO} \cos \omega_{LO}t$. Derive the output of the mixer after low-pass filtering.
- An RF input signal at 900MHz is down-converted in a mixer to an IF frequency of 80MHz. What are the two possible LO frequencies, and the corresponding image frequencies?

Course Outcome 5 (CO5):

- Consider a 50Ω cable, LNA and another amplifier are cascaded together. Their gain and Noise figures are $G_1= -3$ dB, $NF_1= 3$ dB; $G_2= -20$ dB, $NF_2= 1.5$ dB; $G_3=13$ dB, $NF_3= 4$ dB. Compute the overall noise figure.
- Two satellite receiver systems have the following specifications for their components:
 RF Amplifier: $F=5$ dB, $G=10$ dB
 Mixer : $L_c = 5$ dB
 IF amplifier: $F=2$ dB, $G= 15$ dB
 Bandpass filter: $IL=2$ dB
 Compare the two systems in terms of the overall gain and noise figure values.



Concept Map

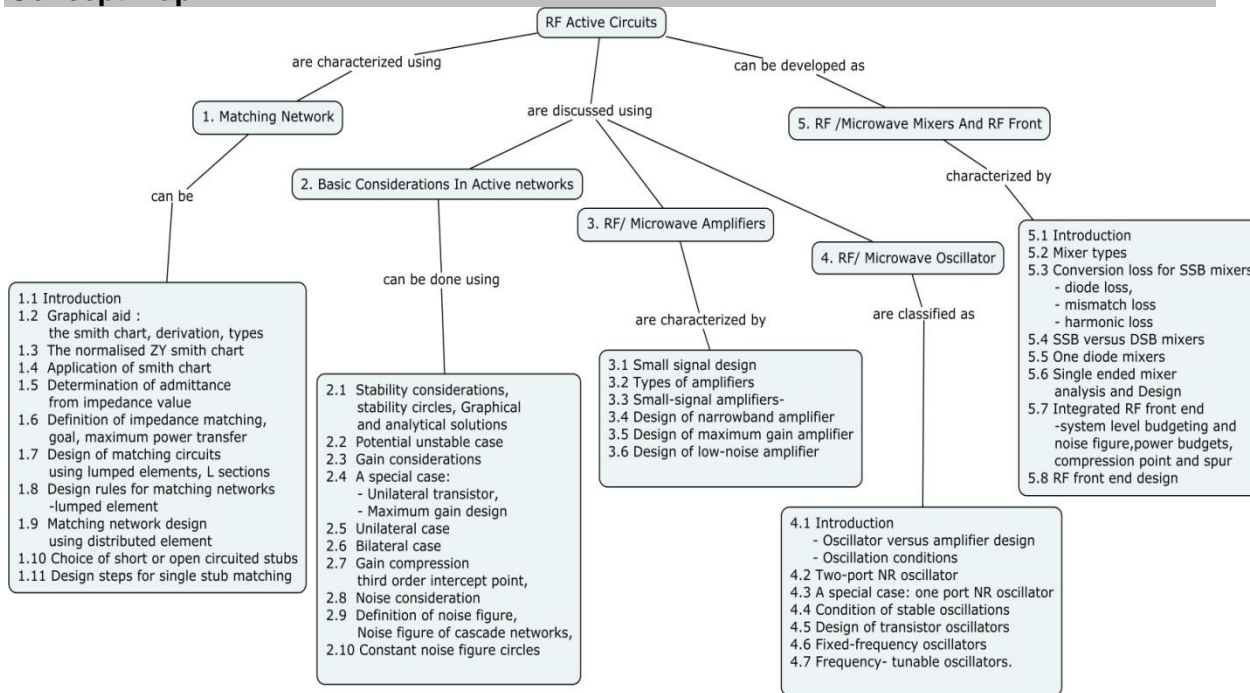

Syllabus

Matching network : Introduction, A valuable graphical aid: the smith chart, derivation, types, The normalised impedance-Admittance(ZY)smith chart, Application of smith chart-distributed circuit applications, Determination of admittance from impedance value-input impedance(Zin),Definition of impedance matching, maximum power transfer, Design of matching circuits using lumped elements, L sections, Design rules for matching networks- lumped element, Matching network design using distributed element, Choice of short- or open circuited stubs, Design steps for single stub matching(using the same characteristic impedance). **Basic Consideration In Active networks:** Stability considerations, stability circles, Graphical and analytical solutions, Potential unstable case, Gain considerations -Power gain concepts, A special case: unilateral transistor, Maximum gain design, Unilateral case(maximum gain and constant gain circles), Gain compression third order intercept point, Noise consideration-Definition and sources, Definition of noise figure, Noise figure of cascade networks, Constant noise figure circles. **RF/Microwave Amplifiers:** Small signal design, Types of amplifiers. Small-signal amplifiers-amplifiers DC-bias circuit design and amplifiers DC-bias RF/MW circuit design, Design of narrowband amplifier(NBA) design, Design of maximum gain amplifier (MGA) design, Design of low-noise amplifier (LNA) design, Commercially available Mixers and Amplifiers. **RF/Microwave Oscillator :** Introduction-Oscillator versus amplifier design, Oscillation conditions, Two-port NR oscillator, A special case: one port NR oscillator, Condition of stable oscillations, Design of transistor oscillators. **RF/Microwave Mixers:** Introduction, Mixer types-up converter and harmonic mixers, Mixer parameters,

Conversion loss for SSB mixers-diode loss, mismatch loss and harmonic loss, SSB versus DSB mixers-conversion loss and noise figure, Single ended mixer. **Integrated RF front end** –System level budgeting, Noise Figure and power budgets

Text Book

1. Matthew M. Radmanesh, "Radio frequency and Microwave Electronics Illustrated", Pearson Education Asia, 2001.

Reference Books

1. David M Pozar: Microwave and RF design of wireless systems, John Wiley & Sons, 2001.
2. David M. Pozar, "Microwave Engineering," John Wiley & Sons, Fourth Edition, 2015.
3. Les Besser and Rowan Gilmore, "Practical RF circuit Design for Modern Wireless Systems- Passive circuits and Systems", Vol.1, Artech House Publishers, Boston, London 2008.

Course Contents and Lecture Schedule

Module No	Topic	No. of Lectures
1.	Matching network	
1.1	Introduction	1
1.2	A valuable graphical aid :the smith chart, derivation, types	1
1.3	The normalised impedance-Admittance(ZY)smith chart	1
1.4	Application of smith chart-distributed circuit applications	1
1.5	Determination of admittance from impedance value-input impedance(Zin),a shunt lumped element and input impedance of single shunt/series relative element	1
1.6	Definition of impedance transfer, matching goal, maximum power transfer	1
1.7	Design of matching circuits using lumped elements, L sections	1
1.8	Design rules for matching networks-lumped element	1
1.9	Matching network design using distributed element	1
1.10	Choice of short- or open circuited stubs,	1
1.11	Design steps for single stub matching (using the same characteristic impedance)	1
2.	Basic Consideration In Active networks	
2.1	Stability considerations, stability circles, Graphical and analytical solutions	1
2.2	Potential unstable case	1
2.3	Gain considerations -Power gain concepts	1
2.4	A special case: unilateral transistor, Maximum gain design, Unilateral case(maximum gain and constant gain circles), Bilateral case	1
2.5	Gain compression third order intercept point,	1
2.6	Noise consideration-Definition and sources,	1
2.7	Definition of noise figure, Noise figure of cascade networks,	1
2.8	Constant noise figure circles	1
3.	RF/ Microwave Amplifiers	
3.1	Small signal design	1
3.2	Types of amplifiers-classes of amplifiers based on operating point and classes of amplifiers based on signal	1

	level	
3.3	Small-signal amplifiers-amplifiers DC-bias circuit design and amplifiers DC-bias RF/MW circuit design	1
3.4	Design of narrowband amplifier(NBA) design,	1
3.5	Design of maximum gain amplifier (MGA) design	1
3.6	Design of low-noise amplifier (LNA) design.	1
4.	RF/ Microwave Oscillator	
4.1	Introduction - Oscillator versus amplifier design,Oscillation conditions	1
4.2	Two-port NR oscillator	1
4.3	A special case: one port NR oscillator	1
4.4	Condition of stable oscillations	1
4.5	Design of transistor oscillators	1
4.6	Fixed-frequency oscillators	1
4.7	Frequency- tunable oscillators.	1
5.	RF /Microwave Mixers And RF Front	
5.1	Introduction	1
5.2	Mixer types-up converter and harmonic mixers, Mixer parameters	1
5.3	Conversion loss for SSB mixers-diode loss, mismatch loss and harmonic loss	1
5.4	SSB versus DSB mixers-conversion loss and noise figure	1
5.5	One diode (single ended) mixers	1
5.6	Single ended mixer analysis and Design procedure and other mixer considerations	2
5.7	Integrated RF front end -system level budgeting and noise figure, power budgets	1
Total		36

Course Designers:

1.	Dr.V. Abhaikumar	principal@tce.edu
2.	Dr.S.Kanthamani	skmece@tce.edu

14EC540	ANALOG AND DIGITAL COMMUNICATION SYSTEMS	Category	L	T	P	Credit
		PC	2	1	0	3

Preamble

The course "14EC540: Analog and Digital Communication Systems" is offered in the fifth semester and is the first course on communication systems. This course aims at designing Analog and Digital communication systems that are used for the transmission of information from source to destination. A detailed quantitative framework for analog and digital transmission techniques is addressed.

Prerequisite

14EC340 Signals and Systems

Course Outcomes

On the successful completion of the course, students will be able to

CO1.Characterize the different analog modulation schemes in time and frequency domains.	Apply
CO2.Analyze the performance of analog modulation schemes in the presence of additive white Gaussian noise.	Analyze
CO3.Determine the minimum number of bits per symbol required to represent the source and the maximum rate at which reliable communication can take place over the channel.	Apply
CO4. Detect and correct the errors introduced in the channel using error control coding schemes.	Apply
CO5. Describe the principle of pulse modulation techniques namely PAM, PPM and PCM.	Understand
CO6. Design the baseband pulse for ISI free transmission over finite bandwidth channels	Apply
CO7. Analyze the BER performance of digital modulation techniques.	Analyze
CO8. Design analog and digital communication systems as per given specifications.	Apply

Mapping with Programme Outcomes

COs	PO 1	PO 2	PO 3	PO 4	PO 5	PO 6	PO 7	PO 8	PO 9	PO 10	PO 11	PO 12	PSO 1	PSO 2	PSO 3
CO1	S	M	L	-	-	-	-	-	L	L	-	L	S	L	L
CO2	S	S	M	L	-	-	-	-	L	L	-	L	S	L	L
CO3	S	M	L	-	-	-	-	-	L	L	-	L	S	L	L
CO4	S	M	L	-	-	-	-	-	L	L	-	L	S	M	L
CO5	M	L	-	-	-	-	-	-	L	L	-	L	S	M	L
CO6	S	M	L	-	-	-	-	-	L	L	-	L	S	M	L
CO7	S	S	M	L	-	-	-	-	L	L	-	L	S	M	L
CO8	S	S	M	L	-	-	-	-	L	L	-	L	S	M	L

S- Strong; M-Medium; L-Low

Assessment Pattern

Bloom's Category	Continuous Assessment Tests			Terminal Examination
	1	2	3	
Remember	20	0	0	0
Understand	20	20	20	20
Apply	60	60	60	60
Analyse	0	20	20	20
Evaluate	0	0	0	0

Create	0	0	0	0
--------	---	---	---	---

Course Level Assessment Questions

Course Outcome 1 (CO1):

- Using the message signal $m(t) = 1/(1+t^2)$, determine the modulated waves for the following methods of modulation,
 - Amplitude modulation with 50 percent modulation
 - Double sideband – suppressed carrier modulation
 - Single side band modulation with only the upper side band transmitted.
 - Single side band modulation with only the lower side band transmitted.
- The single tone modulating signal, $m(t) = A_m \cdot \cos(2\pi f_m t)$ is used to generate the VSB signal $s(t) = (1/2) \cdot a \cdot A_m \cdot A_c \cdot \cos[2\pi(f_c + f_m)t] + (1/2) \cdot A_m \cdot A_c \cdot (1-a) \cdot \cos[2\pi(f_c - f_m)t]$ where, 'a' is a constant, less than unity, representing the attenuation of the upper side frequency.
 - Find the Quadrature component of the VSB signal s(t).
 - The VSB signal, plus the carrier $A_c \cdot \cos(2\pi f_c t)$, is passed through an envelope detector. Determine the distortion produced by the Quadrature component.
 - What is the value of constant, 'a' for which this distortion reaches its worst possible condition?.
- An angle modulated signal with carrier frequency, $\omega_c = 2\pi \cdot 10^5$ is described by $\phi_{EM}(t) = 10 \cdot \cos(\omega_c t + 5 \cdot \sin 3000t + 10 \cdot \sin 2000\pi t)$. Find the power of the modulated signal, frequency deviation, Δf , deviation ratio, β and phase distortion, $\Delta\phi$

Course Outcome 2 (CO2):

- Derive the expression and obtain the channel SNR, Output SNR, and Figure of Merit of FM receivers.
- Derive the expression and obtain the channel SNR, Output SNR, and Figure of Merit for AM – DSB/FC and AM – DSB/SC receivers.
- Derive the expression and obtain the channel SNR, Output SNR, and Figure of Merit of PM receivers.

Course Outcome 3 (CO3):

- Consider a discrete memoryless source with source alphabet, $S = \{s_0, s_1, s_2\}$ and source statistics $\{0.7, 0.15, 0.15\}$. Calculate the entropy of the source. Calculate the entropy of the second – order extension of the source.
- Define average mutual information and average self information.
- Why the theory of information is relevant for understanding the principles of digital communication systems?

Course Outcome 4 (CO4):

- The parity check bits of a (7,3) linear block code are generated by $c_4 = d_1 + d_2, c_5 = d_2 + d_3, c_6 = d_1 + d_2 + d_3, c_7 = d_1 + d_3$, where d_1, d_2 , and d_3 are the message digits.
 - Find the Generator Matrix and Parity Check Matrix for this code
 - Find the minimum weight of this code.
 - Find the error correcting capabilities of this code.

2. A systematic (6,3) linear block code has the generator matrix
$$\begin{bmatrix} 1 & 0 & 0 & 1 & 1 & 0 \\ 0 & 1 & 0 & 0 & 1 & 1 \\ 0 & 0 & 1 & 1 & 0 & 1 \end{bmatrix}.$$

Construct the Standard array and determine the correctable error patterns and their corresponding syndromes.

3. The (3,1) convolutional encoder is shown in figure.1. Assume that four information bits ($x_1 \ x_2 \ x_3 \ x_4$), followed by two zero bits, have been encoded and sent via a binary symmetric channel. The received sequence is (111 111 111 111 111 111). Find the most likely data sequence using Viterbi decoding algorithm.

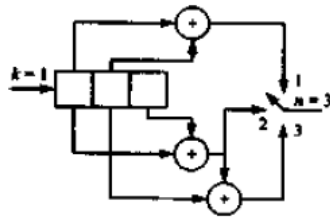

Figure 1

Course Outcome 5 (CO5):

1. A telephone signal with cut – off frequency of 4 KHz is digitized into 8 bit PCM, sampled at Nyquist rate. Calculate base band transmission bandwidth and Quantization signal to noise ratio.
2. The speech signal is transmitted over a PCM channel with 8-bit accuracy. Assume the speech is base band limited to 3.6 KHz. Determine the bit rate.
3. A sinusoidal signal $x(t) = a_o \cos(2\pi f_o t)$ is applied to a delta modulator that operates with a sampling period, T_s and step size, $\Delta = 2\delta$.
 - (a) Find the expression for amplitude, a_o to avoid slope overload distortion.
 - (b) Compute the maximum permissible value of the output signal power.
 - (c) Compute the variation of Quantization noise in delta modulation.
 - (d) Find the maximum value of output signal to noise ratio.
4. A PCM System uses a uniform quantizer followed by a 8 bit binary encoder. The bit rate of the system is 64 Mbps. What is the maximum message bandwidth for which the system operates satisfactorily?
5. In a binary digital communication system using on-off signalling symbol '1' is represented by the pulse $s(t) = a[u(t) - u(t - T)]$ and symbol '0' is represented by $s(t) = -a[u(t) - u(t - T)]$ switching off the pulse. For pre detection filtering, the receiver uses a matched filter, the maximum output of which is sampled and applied it to a decision device. Assume that the receiver noise is white, Gaussian, with zero mean and power spectral density $N_0/2$. Determine the average probability of error when symbols 1 and 0 occur with equal probability.

Course Outcome 6 (CO6):

1. Using Gram-Schmidt orthonormalization procedure, determine orthonormal basis functions for the set of signals given in Figure.2.

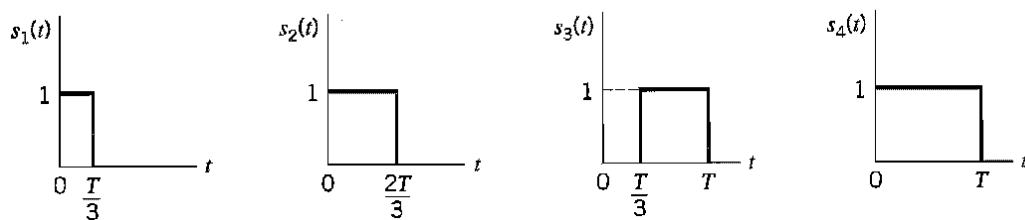
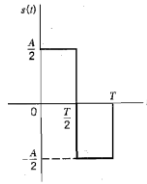

Figure 2

2. Consider the signal shown in figure 3.

Figure 3



Determine the impulse response of a filter matched to this signal and sketch it as a function of time.

3. Consider the signal

$$s(t) = \begin{cases} \left(\frac{A}{T}\right)t \cos 2\pi f_c t & 0 \leq t \leq T \\ 0 & \text{elsewhere} \end{cases}$$

- Determine the impulse response of the matched filter for the signal.
- Determine the output of the matched filter at $t = T$
- Suppose the signal $s(t)$ is passed through a correlator that correlates the input $s(t)$ with $s(t)$. Determine the value of the correlator output at $t = T$. Compare your result with that in (b).

Course Outcome 7 (CO7):

- Derive the expression and obtain the SQNR in a PCM system.
- Derive the Figure of Merit for Pulse Position Modulated system.
- Estimate the improvement factor in frequency modulated system by using Pre-emphasis and de-emphasis circuits.

Course Outcome 8 (CO8):

- Design a binary baseband PAM system to transmit data at a rate of 9600 bits/sec with a bit error probability $P_e < 10^{-5}$. The channel available is an ideal low pass channel with a bandwidth of 9600Hz. The noise can be assumed to be white, Gaussian with a two sided power spectral density $\eta/2 = 10^{-13}$ watts/Hz. Sketch the shape of $|H_T(f)|, |H_R(f)|, |P_g(f)|$, and find the transmitter power constraints.
- A source emits one of three equiprobable symbols in an independent sequence at a symbol rate of 1000/sec. Design a three level PAM system to transmit the output of this source over an ideal low pass channel with additive Gaussian noise having a psd of $\eta/2 = 10^{-14}$ watts/Hz. The symbol error probability has to be maintained at or below 10^{-6} . Specify the power, bandwidth requirements and $H_T(f), H_R(f), P_g(t)$
- Design a PAM system to transmit the output of a source emitting an equiprobable, independent bit stream at a rate of 10,000 bits/sec over an ideal low pass channel of width 5000Hz and additive Gaussian noise with a psd= 10^{-12} watt/Hz. P_e has to be maintained at or below 10^{-4} .

Concept Map

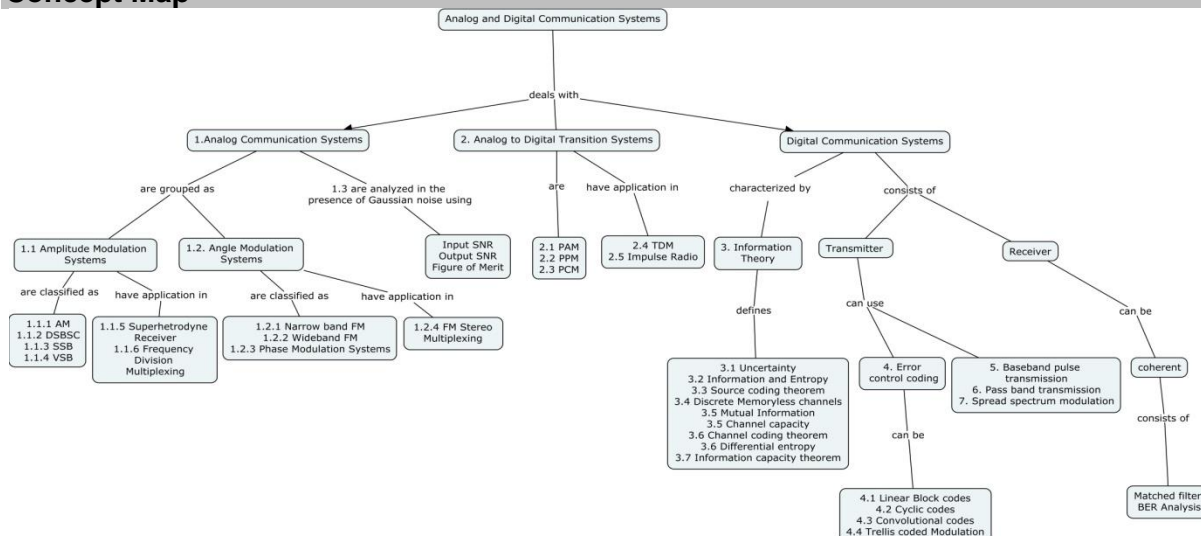

Syllabus

Analog Communication Systems: Amplitude Modulation, Double Side band Suppressed Carrier Modulation, Single side band Modulation, Vestigial Side band Modulation, Super heterodyne Receiver, Frequency Division Multiplexing, Angle Modulation Systems: Narrow band and wideband FM, Generation and demodulation of FM waves, Phase Modulation systems, Noise Analysis.

Analog to Digital Transition Systems: Pulse Amplitude Modulation, Pulse Position Modulation, Pulse Code Modulation, DPCM, Delta Modulation, Time Division Multiplexing, Impulse Radio

Information Theory: Uncertainty, Information and entropy, source coding theorem, Discrete Memoryless channels, Mutual Information, Channel capacity, Channel coding theorem, Differential entropy, Information capacity theorem

Error control coding: Linear block codes, cyclic codes, convolutional codes, Trellis coded Modulation

Baseband Pulse transmission: Inter Symbol Interference problem, Nyquist criterion, Raised cosine pulse, partial response signals

Passband Transmission: Binary Amplitude Shift Keying, Binary Phase Shift Keying, Binary Frequency Shift Keying, Orthogonal Frequency Division Multiplexing, Digital Television, BER Analysis

Spread Spectrum Modulation: Pseudo noise sequences, Discrete sequence spread spectrum with coherent BPSK, Signal space dimensionality and processing gain, Frequency hop spread spectrum modulation

Text Book

1. Simon Haykin and Michael Moher, "Communication systems" John Wiley & Sons, Fifth Edition, 2016

Reference Books

1. Simon Haykin and Michael Moher, "An Introduction to Analog and Digital Communications", John Wiley & Sons, second Edition, 2006.
2. Leon W. Couch II, "Digital and Analog Communication Systems", Prentice Hall, 1997
3. Sam Shanmugam, "Digital and Analog Communication Systems", 2nd ed, John Wiley, 1992.
4. B. Carlson, "Introduction to Communication systems", 3rd Edition, McGraw Hill, 1989

Course Contents and Lecture Schedule		
Module No.	Topic	No. of Lectures
1	Analog Communication Systems	
1.1	Amplitude Modulation	1
1.2	Double Side band Suppressed Carrier Modulation	1
1.3	Single side band Modulation	1
1.4	Vestigial Side band Modulation	1
1.5	Super heterodyne Receiver	1
1.6	Frequency Division Multiplexing	1
1.7	Angle Modulation Systems	1
1.8	Narrow band Frequency Modulation	1
1.9	Wide band Frequency Modulation	1
1.10	Generation and Demodulation of FM waves	2
1.11	Phase Modulation systems	1
1.12	Noise analysis	2
2	Analog to Digital Transition Systems	
2.1	Pulse Amplitude Modulation	1
2.2	Pulse Position Modulation	1
2.3	Pulse Code Modulation	1
2.4	Time Division Multiplexing, Impulse Radio	2
3	Information Theory	
3.1	Uncertainty, Information and entropy	1
3.2	source coding theorem	1
3.3	Discrete Memoryless channels	1
3.4	Mutual Information, Channel capacity	1
3.5	Channel coding theorem	1
3.6	Differential entropy, Information capacity theorem	2
4	Error Control Coding	
4.1	Linear block codes	2
4.2	cyclic codes	2
4.3	convolutional codes	2
4.4	Trellis coded Modulation	1
5	Baseband Pulse transmission	
5.1	Inter Symbol Interference problem, Nyquist criterion	2
5.2	Raised cosine pulse, partial response signals	1
6	Passband Transmission	
6.1	Binary Amplitude Shift Keying	1
6.2	Binary Phase Shift Keying	1
6.3	Binary Frequency Shift Keying	1
6.4	Orthogonal Frequency Division Multiplexing	1
6.5	Digital Television	1
6.6	BER Analysis	3
7	Spread Spectrum Modulation	
7.1	Pseudo noise sequences	1
7.2	Discrete sequence spread spectrum with coherent BPSK	1
7.3	Signal space dimensionality and processing gain	1
7.4	Frequency hop spread spectrum modulation	1
	Total	48

Course Designers:

1.	Dr.S.J.Thiruvengadam	sjtece@tce.edu
2.	Dr.M.N.Suresh	mnsece@tce.edu
3.	Dr.G.Ananthi	gananthi@tce.edu

14EC570	IMAGE PROCESSING	Category	L	T	P	Credit
		PC	2	0	2	3

Preamble

The purpose of this course is to provide the basic concepts and methodologies for Digital Image Processing in three different levels. At the lowest level, the course introduces the terminology of image processing, how digital images are acquired, how the data is stored, image formats; relationship between pixels and spatial & frequency domain concepts for enhancement. In the middle level, it addresses how the algorithm utilizes low level results for the next level processes such as extracting useful information and morphological processing. At highest level, it addresses how the algorithm attempts to extract the semantic information (representors and descriptors) from those provided by the lower levels for real world image processing applications.

Prerequisite

14EC440 Signal Processing

Course Outcomes

On the successful completion of the course, students will be able to

CO1.	Demonstrate how digital images are acquired, stored and relationship between pixels	Understand
CO2.	Perform techniques to enhance of contrast and thereby improve the visual perception of contrast degraded imagery.	Apply
CO3.	Remove noise from real-world imagery using a variety of filtering techniques in both the spatial and frequency domain.	Apply
CO4.	Apply image processing techniques to imagery in order to detect structures such as points, lines and edges.	Understand
CO5.	Detect/Extract regions of interest from an image using various segmentation, representation, Description techniques and employ morphological algorithm to clean up and cluster such regions for further analysis.	Apply
CO6.	Identify and apply these techniques to solve real-world image processing problems and propose solutions for the same.	Analyze

Mapping with Programme Outcomes

COs	PO 1	PO 2	PO 3	PO 4	PO 5	PO 6	PO 7	PO 8	PO 9	PO 10	PO 11	PO 12	PSO 1	PSO 2	PSO 3
CO1	M	L	-	-	M	-	-	L	L	L	-	-	L	-	L
CO2	S	S	M	L	M	M	-	L	M	M	-	L	M	S	L
CO3	S	S	M	L	M	L	L	L	M	M	-	L	M	S	L
CO4	S	S	M	L	M	L	-	L	M	M	-	L	M	M	L
CO5	S	S	M	L	M	M	L	L	M	M	-	L	M	S	L
CO6	S	S	M	L	S	M	M	L	M	M	-	L	S	S	M

S- Strong; M-Medium; L-Low

Assessment Pattern

Bloom's Category	Continuous Assessment Tests			Terminal Examination
	1	2	3	
Remember	20	20	Practical	20
Understand	20	20		20
Apply	60	60		60
Analyse	0	0		0

Evaluate	0	0		0
Create	0	0		0

Course Level Assessment Questions**Course Outcome 1 (CO1):**

- Write digital image model and list different imaging sensors.
- Distinguish CT and MRI imaging techniques and List the Pros and Cons.
- If the intensity values of $f(x, y)$ are available at (11, 4) and (6, 9), find Euclidean Distance, chess board distance between these two pixels.
- Consider the image segment shown.

Let $v = \{0,1\}$, and obtain the shortest 8 and m-path between p and q. If a particular path does not exist between these two points state the reason. Repeat the same for $v \{1,2\}$.

3 2 1 0 (q)

2 1 2 0

1 1 1 1

(p) 1 0 1 2

- Explain two dimensional sampling (down sample to 2X2) and 4 bit (16 gray levels) quantization for the following 8 bit sub image and state the reasons for the effects due to these processes?

255	255	255	255	255	255	255	255
255	200	255	150	255	50	50	255
255	200	255	150	255	50	50	255
255	200	255	150	255	50	50	255
255	200	255	150	255	50	50	255
255	200	255	150	255	50	50	255
255	200	255	150	255	50	50	255
255	255	255	255	255	255	255	255

Course Outcome 2 (CO2):

- Justify whether the image is poor in contrast. Identify the category of contrast. Is there any possibility to apply histogram equalization for the enhancement? If Yes, Justify and apply Histogram equalization for the following 6 bit image segment of size 6X6? Write the inference on image segment before and after equalization.

35	55	60	55	40	60
55	35	35	60	60	52
60	48	45	55	38	48
51	40	60	45	40	40
49	40	60	35	35	55
62	48	55	62	45	35

- Demonstrate the following gray-level transformations for image enhancement via
 - Gamma correction
 - Gray level slicing
 - Contrast Stretching
- Using bit plane coding if you display only MSB bits can you identify the image segment. Justify your answer.

Course Outcome 3 (CO3):

- How order statistics filters are used to remove impulse, Gaussian and uniform noise?
- Illustrate how smoothing of images can be carried out in frequency domain.

3. Compute Fourier Transform and its inverse for the following image data. [200 20; 20 200] [2x2] matrix. If phase of the given image matrix and magnitude of other image matrix is available can you recover original image?
4. Give the PDF of salt and pepper noise and sketch the PDF.

Course Outcome 4 (CO4):

1. Give the linear filter masks for detecting -45° and horizontal lines.
2. Write the Prewitt and Sobel masks to detect horizontal and vertical edges in an image. Write the significance of Sobel.
3. State and sketch the zero crossing property of the second derivative.
4. List the merits and demerits of LoG (Laplacian of Gaussian) function.

Course Outcome 5 (CO5):

1. The region-growing algorithm starts with a seed pixel. Suggest a way or gray level range to choose the seed pixel for the following two applications.
 - a. Segmenting the fractured portion of a leg in a X-Ray image
 - b. Segmenting defective welds for an image captured in industry
2. Deduce the shape number for the following shape?

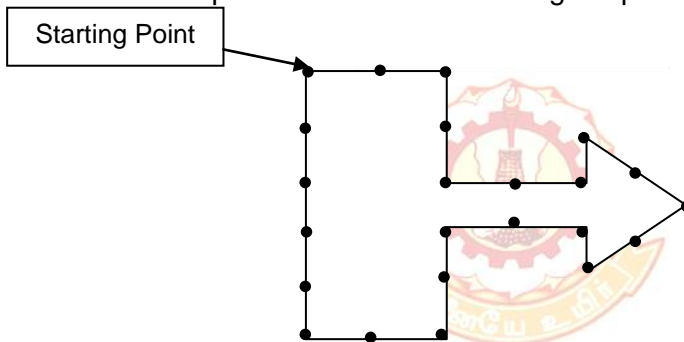

3. Illustrate any one application of segmentation by region merging and splitting. The 8-directional chain code of the image is given by 2 2 2 2 2 2 2 2 7 7 7 7 7 7 7 2 2 2 2 2 2 2. Where the (8, 1) provide the row and column axes of the initial point respectively. Decode the chain code and draw the decoded image in the 8x8 grid.

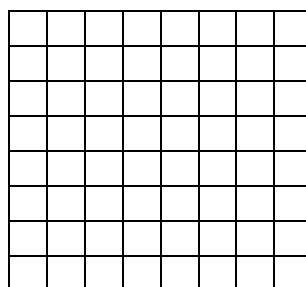

4. Represent the following boundaries using signatures.
 - c. A trapezoid
 - d. A rectangle having length and width as 4 and 2.
 - e. A circle with radius 3.

Course Outcome 6 (CO7):

1. In industrial inspection (PCB board), they need an automated system to identify the missing component. Suggest an algorithm to give solution
2. The Intelligent traffic surveillance team asks you to develop an application for them. You have to apply image processing algorithms to find rectangles whose size makes them suitable candidates for Number plate identification for a vehicle. Also, suggest an algorithm to link edges of the number plate.

- Suggest an algorithm to find the change between two satellite images (taken in 2004 and 2014). The image captured the Madurai area. How will you find vaigai river has been encroached and how much encroached from the change detection algorithm.
- The region-growing algorithm starts with a seed pixel. Suggest a way or gray level range to choose the seed pixel for the following application. Segment the tumor in brain CT image (tumor is white in color). Assume the intensity values are 255 (white) for tumor and 0 for normal and consider as input values. Analyze the image and find out whether the extracted portion is tumor or not.

Concept Map

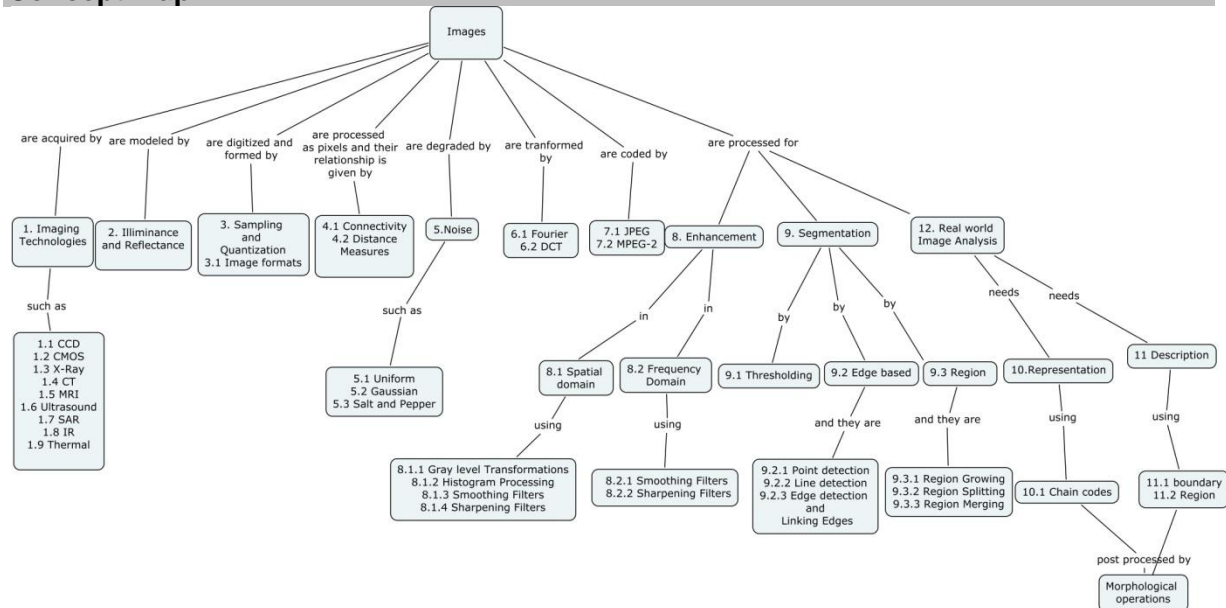

Syllabus

Imaging Technologies: Introduction to Image processing, it's need and applications - Image sensing and acquisition- CCD, CMOS, X-Ray, CT, MRI, Ultrasound, SAR, IR, Thermal- Imaging Components of an Image processing system.

Digital Image Model: Illuminance and Reflectance: Image formats, Image Sampling and Quantization –Basic relationship between pixels- Connectivity and Distance measures.

Image Enhancement: Noise models -Gray level Transformations – Histogram processing – Fourier- Discrete cosine Transform –Spatial and Frequency domain filtering – smoothing, sharpening filters.

Coding Techniques: JPEG, MPEG-2

Segmentation: Thresholding –Threshold selection- Point, Line and Edge detection, Edge linking, Laplacian Mask based operations- Region based segmentation – Region growing– Region splitting & merging

Representation and Description: Chain codes–Boundary descriptors –Regional Descriptors – Texture –Morphology - dilation and erosion – opening and closing.

Real world Image Analysis: License plate detection, CT image analysis, Non-destructive testing, Remote sensing change detection, crack detection, Missing component detection.

Practical:

- Poor contrast image enhancement using Histogram Equalization.
- Removal of Gaussian or salt and pepper noise in an image.
- JPEG image compression using DCT coding.
- Vehicle license plate detection by mask operations.
- CT /Ultra sound image analysis to detect abnormality.
- Testing Non-destruction of a given image.
- Change detection between two different, remotely sensed satellite images.

8. Missing component detection in an automated industrial inspection application.

Text Book

1. Rafael.C.Gonzalez and Richard.E. Woods, "Digital Image Processing", Third Edition, Prentice Hall, 2008.

Reference Books and Resources

1. Rafael.C.Gonzalez, Richard.E. Woods and Steven L. Eddins, "Digital Image Processing using MATLAB", 2nd Edition, Gatesmark Publishing, 2009.
2. Al.Bovik, "The Essential Guide to Image Processing", Academic Press, 2009.
3. Anil K.Jain, "Fundamentals of Digital Image Processing", Pearson Education 2003.
4. William K. Pratt, "Digital Image Processing", Third Edition, John Wiley, 2001.
5. www.imageprocessingplace.com.
6. <https://www.coursera.org/course/images>.
7. <http://www.mathworks.com>.

Course Contents and Lecture Schedule

No.	Topic	No. of Lectures
1	Imaging Technologies	
1.1	Introduction to Image processing, it's need and applications, CCD, CMOS	2
1.2	X-Ray, CT, MRI, Ultrasound	1
1.3	SAR	1
1.4	IR	
1.5	Thermal	
2	Digital Image model	
2.1	Illuminance and Reflectance	1
3	Digitization	
3.1	Sampling and Quantization	1
3.2	Image Formats	
4	Relationship between pixels	
4.1	Connectivity	2
4.2	Distance Measures	
5.	Noise	
5.1	Uniform, Gaussian, Salt and Pepper	1
6.	Transforms	
6.1	Fourier	1
6.2	Discrete cosine	1
7	Image Coding Techniques	
7.1	JPEG	1
7.2	MPEG 2	1
8	Image Enhancement	
8.1	Spatial domain	
8.1.1	Gray level Transformations	1
8.1.2	Histogram Processing	1
8.1.3	Smoothing Filters	1
8.1.4	Sharpening Filters	
8.2	Frequency Domain	
8.2.1	Smoothing Filters	
8.2.2	Sharpening Filters	1
9	Segmentation	
9.1	Thresholding based segmentation	
9.2	Point, Line and Edge Detection, Laplacian mask based operations and linking edges	1

9.3	Region based segmentation	
9.3.1	Region Growing, Region Splitting	1
9.3.2	Region Merging	
10	Representation	
10.1	chain codes	1
11	Description	
11.1	Boundary	1
11.2	Region	
12	Real world Image Analysis	
12.1	License plate detection,	1
12.2	Missing component detection	
12.3	CT, Ultra sound image analysis	1
12.4	Non-destructive testing	1
12.5	Remote sensing change detection	
12.6	crack detection	
	Total	24

Course Designers:

1.	Dr.S.Md.Mansoor roomi	smmroomi@tce.edu
2.	Dr.A.Banumathi	au_banu@tce.edu
3.	Dr.B.Yogameena	ymece@tce.edu



14EC580	DATA COMMUNICATION NETWORKING LABORATORY	Category	L	T	P	Credit
		PC	0	0	1	1

Preamble

The goals of this course are to supplement the theory course '14EC510 Data Communication Networks' and to assist the students in obtaining a better understanding of the characteristics of data communication networks by giving hands on programming and lab activities to the students in practicing the data communication concepts and protocols.

Prerequisite

Nil

Course Outcomes

On the successful completion of the course, students will be able to

CO1	Use the IP based diagnostic commands to support troubleshooting in IP networks	Apply
CO2	Analyze the throughput performance of different network topologies	Analyze
CO3	Design structured cabling using Straight through, Cross over and Rollover cables.	Apply
CO4	Use CISCO Simulator Tool for router configuration and Java SDK Tool for Socket Programming to build/configure network applications.	Apply
CO5	Analyze the network performance using packet sniffer tools – NETMON / Wireshark	Analyze
CO6	Use of network simulator package – NS2/NS3 to simulate the point-to-point networks and analyze their performance	Analyze

Mapping with Programme Outcomes

COs	PO 1	PO 2	PO 3	PO 4	PO 5	PO 6	PO 7	PO 8	PO 9	PO 10	PO 11	PO 12	PSO 1	PSO 2	PSO 3
CO1	M	S	-	L	S	-	-	L	M	L	-	-	M	-	L
CO2	S	M	M	M	S	-	-	S	L	M	-	L	S	L	L
CO3	M	M	-	L	S	-	-	L	M	L	L	-	M	-	L
CO4	M	M	-	L	S	-	-	M	L	M	L	L	M	-	L
CO5	S	S	M	M	S	-	-	L	L	M	L	L	S	L	L
CO6	S	S	M	M	S	-	-	L	L	L	L	L	S	L	L

S- Strong; M-Medium; L-Low

Syllabus

- Configuring TCP/IP parameters and troubleshooting network connectivity using DOS networking utilities
 - ipconfig /all
 - hostname
 - ping
 - nslookup
 - netstat
 - tracert
- Basic programs using Java SDK
 - Finding Internet Protocol Address and host name for a particular host machine
 - Finding IP Addresses for popular domain names
 - Scanning / Tracing the ports of a particular host
- Comparing the throughput analysis for different LAN topologies
 - Simulate an Ethernet LAN using N-nodes (6-10)
 - Set packet size, duration, bit delay.

- c. Change error rate and data rate
 - d. Compare the throughput
4. Implementing Flow control protocols
 - a. Stop-and-wait protocol
 - b. Sliding window protocol
5. Developing a client – server models using TCP Sockets.
 - a. Implementing Time Server
 - b. Implementing Chat Server
 - c. Implementing File Server
 - d. Implementing Math Server
6. Developing a client – server models using UDP Sockets.
 - a. Implementing Time Server
 - b. Implementing Chat Server
 - c. Implementing File Server
 - d. Implementing Math Server
7. Implementing Structured Cabling concepts using
 - a. Straight through cable
 - b. Cross over cable
 - c. Roll over cable
8. Capturing data traffic for Protocol Analysis using Sniffer Tools - Wireshark/ NETMON
 - a. Exploring HTTP, DNS
 - b. Exploring TCP, UDP
 - c. Exploring ICMP, ARP, IP
 - d. Exploring Ethernet
9. Configuring Routers using CISCO simulator
 - a. Studying IOS router modes and commands
 - b. Checking the connectivity between any two configured routers
 - c. Tracing the route between them
 - d. Finding the routing table of router
10. Constructing the point-to-point networks using network simulator packages – NS2
 - a. Simulate the nodes in the network with duplex links between them.
 - b. Set the queue size, packet size and packet interval time.
 - c. Choose suitable link parameters such as link delay and link bandwidth for CBR traffic with UDP / TCP agent and observe the packet dropping phenomena.

Course Designers:

1	Dr.MSK. Manikandan	manimsk@tce.edu
2	Mrs. E. Murugavalli	murugavalli@tce.edu

14EC590	ANALOG AND DIGITAL COMMUNICATIONS LABORATORY	Category	L	T	P	Credit
		PC	0	0	1	1

Preamble

The course “14EC590: Analog and Digital Communications Laboratory” is offered in the fourth semester concurrent with the course on “Analog and Digital Communication Systems”. The purpose of this course is to give hands on training to the students in understanding the theory of communications and practicing sessions used in analog and digital communication systems. This will improve the understanding capability of the communications and simulation capability of the communications.

Prerequisite

Nil

Course Outcomes

On the successful completion of the course, students will be able to

CO1	Construct and test Analog modulation and demodulation circuits	Understand
CO2	Construct and test circuits for pulse amplitude and pulse position modulation circuits	Understand
CO3	Construct and test circuits for digital modulation and spreading sequences	Understand
CO4	Simulation of Analog modulation and Demodulation schemes	Understand
CO5	Simulation of performance analysis of Digital modulation schemes	Analyze

Mapping with Programme Outcomes

COs	PO 1	PO 2	PO 3	PO 4	PO 5	PO 6	PO 7	PO 8	PO 9	PO 10	PO 11	PO 12	PSO 1	PSO 2	PSO 3
CO1	S	M	L	-	S	-	-	-	M	M	-	L	S	L	L
CO2	S	M	L	-	S	-	-	-	M	M	-	L	S	L	L
CO3	S	M	L	-	S	-	-	-	M	M	-	L	S	L	L
CO4	S	M	L	-	S	-	-	-	M	M	-	L	S	M	L
CO5	S	M	L	-	S	-	-	-	M	M	-	L	S	M	L

S- Strong; M-Medium; L-Low

Syllabus

1. Generation of Amplitude Modulation and Demodulation
2. Double Side Band Suppressed Carrier Modulation (DSBSC) and Demodulation
3. Frequency Modulation and Demodulation
4. Pre-emphasis and De-emphasis
5. Pulse Amplitude Modulation, Pulse Position Modulation
6. Digital to Quantization level converter
7. Generation of ASK,FSK and PSK and QPSK
8. Generation of PN Sequences and Direct sequence spread spectrum
9. Simulation of Analog Modulation schemes in MATLAB
10. Simulation of BER analysis of Digital Modulation schemes in AWGN using MATLAB

Course Designers:

- | | |
|-------------------------|------------------|
| 1. Dr.S.J.Thiruvengadam | sjtece@tce.edu |
| 2. Dr.M.N.Suresh | mnsece@tce.edu |
| 3. Dr.G.Ananthi | gananthi@tce.edu |
| 4. Dr.P.G.S.Velmurugan | pgsvels@tce.edu |

CURRICULUM AND DETAILED SYLLABI

FOR

SIXTH SEMESTER

B.E. DEGREE PROGRAMME



**FOR THE STUDENTS ADMITTED IN THE
ACADEMIC YEAR 2014-15 ONWARDS**

**DEPARTMENT OF ELECTRONICS AND COMMUNICATION
ENGINEERING
THIAGARAJAR COLLEGE OF ENGINEERING**

(A Government Aided ISO 9001:2008 certified Autonomous Institution affiliated to Anna University)
MADURAI – 625 015, TAMILNADU

Phone: 0452 – 2482240, 41
Fax: 0452 2483427
Web: www.tce.edu

14EC610	MANAGEMENT THEORY AND PRACTICE	Category	L	T	P	Credit
		PC	3	0	0	3

Preamble

Management is the process of designing and maintaining an environment in which individuals, working together in groups, accomplish their aims effectively and efficiently. It includes the process of carrying out the essential functions of planning, organizing, staffing, leading and controlling. It is the science of managing the operations for an enterprise or organization. It deals with managing men, machine, material and money. Management applies to every kind of organization, whether it is large or small, manufacturing or service enterprise, profit making or non-profit making organization. This course includes the behavioural management, human resources management & facility planning and Productivity. It has become an essential need to analyze the basic concepts of management theory and to understand the ways and means of implementing them in practice.

Prerequisite

NIL

Course Outcomes

On the successful completion of the course, students will be able to

CO1	Explain the concept of Management, nature, functions of Management & Management by Objectives	Understand
CO2	Identify the process of Group formation, Communication, Leadership and utilize the relevant knowledge in practising effective communication and Leadership.	Apply
CO3	Develop an appropriate model for the Recruitment, selection, training & development and Promotion.	Apply
CO4	Plan and utilize the concepts of Plant Location & Layout, Material Handling and Plant Maintenance in improving the overall production of the organisation	Apply

Mapping with Programme Outcomes

COs	PO 1	PO 2	PO 3	PO 4	PO 5	PO 6	PO 7	PO 8	PO 9	PO 10	PO 11	PO 12	PSO 1	PSO 2	PSO 3
CO1	M	L	L	-	-	-	-	L	S	S	S	M	L	-	S
CO2	-	-	M	M	L	-	-	-	-	S	L	M	L	-	M
CO3	-	-	-	-	-	-	-	M	M	M	M	M	-	-	M
CO4	-	M	M	M	M	-	-	-	M	M	M	M	L	L	M

S- Strong; M-Medium; L-Low

Assessment Pattern

Bloom's Category	Continuous Assessment Tests			End Semester Examination
	1	2	3	
Remember	20	20	20	20
Understand	40	40	40	40
Apply	40	40	40	40
Analyze	0	0	0	0
Evaluate	0	0	0	0
Create	0	0	0	0

Course Level Assessment Questions

Course Outcome 1 (CO1):

1. Differentiate Organization and administration?
2. Discuss Management is the science or Art?
3. Explain the Principles of Management framed by Henry Fayol?
4. Explain in the various functions of Management?
5. Explain the types of Organization?

Course Outcome 2 (CO2):

1. Show the steps required to form the group to do the project in your organization?
2. Perform the group to increase the cohesiveness and mention the provisions to reduce conflicts in the organization?
3. List the various barriers in communication to your employees as a manager of your Organization?
4. Adapt the required Leadership style required in an educational Institution?

Course Outcome 3 (CO3):

1. Show the modalities of selection of a trainee engineer to be recruited for a embedded system firm?
2. Compute the Performance Appraisal for the managers in the different department of your organization?
3. List the various provisions to undergo training for the employees in the organization?

Course Outcome 4 (CO4):

1. Demonstrate a proposal as a manager to locate a site to establish a telecommunication industry.
2. Compute all the possible ways to increase the overall productivity of a Electronics manufacturing sector.
3. Produce a preventive maintenance schedule for an electronic equipment manufacturing company which operates for three shifts in 24 hours for 8 hours per shift by 6.00 AM to 2.00 PM, 2.00 PM to 10.00 PM and 10.00 PM to 6.00 AM.
4. Prepare a list of Material handling Equipments with their characteristics with respect to materials, movement, path followed, speed, supervision and power required.

Concept Map

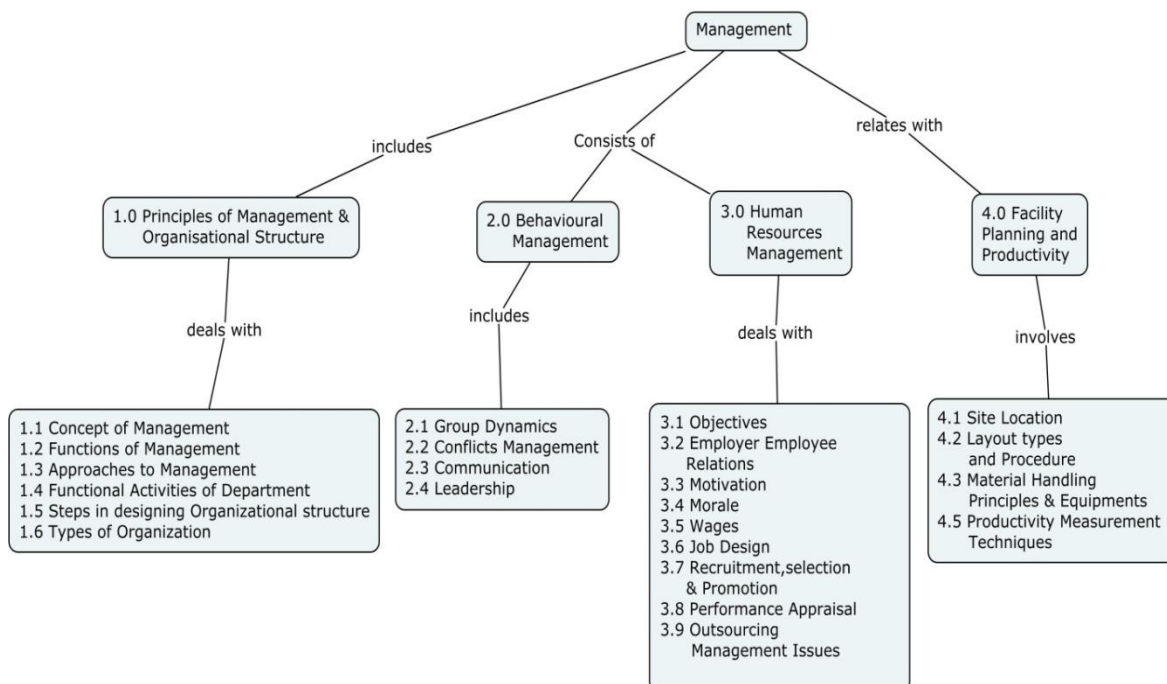

Syllabus:**Management and Functions of Management**

Concept of management, Management, organization, Administration-Management is Science or Art, Taylors Scientific Management – Henry Fayol’s Principles of management - Functions of management- planning, Organizing, Staffing, leading and Controlling, different approaches to management, various functional activities of different departments, Strategic planning, Management by Objectives, Management by Exception, Organization Structure-Principles, Steps in designing an Organization-Types of Organization.

Behavioural Management

Group dynamics, types of groups, formation of group, Group cohesiveness, conflicts management, Communication –meaning and types, barriers in communication, communication in Groups, Leadership styles

Human Resources Management

Objectives-Employer-Employee relations-Motivation-Morale-Ways of achieving high morale-collective bargaining - Psychology - Wage and wage payments-incentives-job design, job analysis-job description, job rotation, job evaluation and merit rating-Recruitment, Selection and training of employees-Promotion-Performance appraisal-Outsourcing Management-issues.

Facility Planning and Productivity

Site location-Factors to be considered-layout-objectives, types, factors influencing layout, layout procedure-Materials handling-principles, factors affecting the choice of materials handling, Materials handling equipment-Plant maintenance-need functions and types-Productivity-definition and concept, techniques for productivity measurement.

Text Books

1. Harold Koontz, Heinz Weihrich, “Essentials of Management”, 8th Edition Tata McGraw Hill, 2010.
2. O.P. Khanna, “Industrial Engineering and Management”, Dhanpat Rai Publications, 2010.

Reference Books

1. LM Prasad , "Principles and Practice of Management", 9th Edition, Sultan Chand & Sons, 2016
2. Chase, Jacobs, Aquilano, “Production and Operations Management” 8th Edition, Tata McGraw Hill Companies Inc, 1999.
3. R.N. Gupta, “Principles of Management”, S.Chand and Co Ltd, 2008.

Course Contents and Lecture Schedule

Module No.	Topic	No. of Lectures
1	Management and Functions of Management	
1.1	Concept of management, Organization, Administration,	1
1.2	Management is science or art, Taylor’s Scientific Management	1
1.3	Henry Fayol’s Principles of management	1
1.4	Functions of management- Planning, organizing, Staffing, leading and controlling	2
1.5	Different approaches to management	1
1.6	Functional activities of different Department, Strategic Planning, MBO, MBE	2
1.7	Principles and Steps in designing an Organization ,Types	1
1.8	Types of Organization	1
2	Behavioural Management	
2.1	Group Dynamics, types of group	1
2.2	formation of group, group cohesiveness	1

2.3	Conflicts management	1
2.4	Communication- Types, barriers, communication in groups	2
2.5	Leadership styles	1
3	Human Resources Management	
3.1	Objectives, Employer- Employee relations, Motivation	1
3.2	Morale, ways of achieving high morale, collective bargaining, Psychology	2
3.3	wage and wage payments, incentives	1
3.4	Job Design, job analysis-job description,	2
3.5	job rotation, job evaluation and merit rating	2
3.6	Recruitment, Selection & Training and Promotion	2
3.7	Performance appraisal-Outsourcing Management-issues.	2
4	Facility Planning and Productivity	
4.1	Site Location , factors to be considered	1
4.2	Layout objectives, types	1
4.3	factors influencing layout, layout procedure	1
4.4	Material Handling - principles,	1
4.5	factors affecting the choice of materials handling, materials handling equipments	1
4.6	Plant Maintenance, need, functions and types	1
4.7	Productivity, definition and concept	1
4.8	Techniques for productivity measurement	1
	Total	36 hrs

Course Designer:

1. Mr.B.Brucelee	bbmech@tce.edu
------------------	--

14EC620	WIRELESS COMMUNICATION SYSTEMS	Category	L	T	P	Credit
		PC	2	1	0	3

Preamble

The objective of this course is to present the techniques in the physical layer aspects of wireless communication systems and determine the performance of wireless systems in terms of capacity and probability of error.

Prerequisite

14EC540 Analog and Digital Communication Systems

Course Outcomes

On the successful completion of the course, students will be able to

CO1. Describe the cellular concept of Wireless Communication Systems.	Understand
CO2. Describe the Mathematical model of a wireless channel.	Understand
CO3. Determine the capacity of wireless systems in Rayleigh fading and frequency selective fading environments.	Apply
CO4. Determine the BER performance of digital modulation schemes in fading environment.	Apply
CO5. Apply the concept of multiple input and multiple output (MIMO) to mitigate fading effect in wireless Communication Systems.	Apply
CO6. Determine the performance of OFDM based wireless communication systems in fading environment.	Apply
CO7. Analyze the performance of a given wireless communication system	Analyze

Mapping with Programme Outcomes

COs	PO 1	PO 2	PO 3	PO 4	PO 5	PO 6	PO 7	PO 8	PO 9	PO 10	PO 11	PO 12	PSO 1	PSO 2	PSO 3
CO1	M	L	-	-	-	-	-	-	L	L	-	-	S	L	L
CO2	S	M	L	-	-	-	-	-	L	L	-	-	S	L	L
CO3	S	M	L	-	M	-	-	-	L	L	-	-	S	L	L
CO4	S	M	M	-	M	-	-	-	L	L	-	-	S	M	L
CO5	S	M	L	-	L	-	L	-	L	L	-	-	S	M	L
CO6	S	M	L	-	L	-	L	-	L	L	-	M	S	M	L
CO7	S	S	M	L	L	-	-	-	L	L	-	M	S	S	L

S- Strong; M-Medium; L-Low

Assessment Pattern

Bloom's Category	Continuous Assessment Tests			Terminal Examination
	1	2	3	
Remember	20	10	0	0
Understand	20	20	20	20
Apply	60	60	60	60
Analyse	0	0	20	20
Evaluate	0	0	0	0
Create	0	0	0	0

Course Level Assessment Questions**Course Outcome 1 (CO1):**

1. If a total of 33MHz of bandwidth is allocated to a particular FDD Cellular telephone system which uses two 25KHz simplex channels to provide full duplex voice and control channels, compute the number of channels available per cell for four cell reuse system.

2. Show that the frequency reuse factor for a cellular system is given by k/s , where k is the average number of channels per cell, and s is the total number of channels available to the cellular service provider.
3. Find the far field distance for an antenna with maximum dimension of 1m and operating frequency of 900MHz.

Course Outcome 2 (CO2):

1. A Wireless channel has a multipath spread of 1msec. The total channel bandwidth at bandpass available for signal transmission is 5KHz. Determine the coherence bandwidth. Is the channel frequency selective? Justify.
2. In mobile multipath channels, if the baseband signal bandwidth is much greater than Doppler spread how do you name the channel? Why is it called so?
3. Assume a mobile traveling at a velocity of 10m/sec receives two multipath components at a carrier frequency of 1000MHz. The first component is assumed to arrive at $\tau = 0$ with an initial phase of 0 degree and the power of -70dBm and the second component which is 3dB weaker than the first component is assumed to arrive at $\tau = 1\mu s$ also with a initial phase of 0 dB. If the mobile moves directly towards the direction of arrival of the first component and directly away from the direction of arrival the second component, compute the average narrow band power received over this observation interval.

Course Outcome 3 (CO3):

1. Find the capacity of AWGN Channel has a bandwidth of 1MHz, signal power is 10Watts and noise spectral density is 10^{-9} Watts/Hz.
2. Determine the capacity of slow fading channel and prove that the outage probability is $P_{out}(R) = \frac{2^R - 1}{SNR}$ where R is the data rate.
3. Consider a flat fading channel with i.i.d channel gain $g[i]$ which can take on three possible values: 0.05, 0.5 and 1 with probabilities 0.1, 0.5 and 0.4. The transmit power is 10mw, the noise spectral density is $N_0 = 10^{-9}$ W/Hz and the channel bandwidth is 30KHz. Assume the receiver has knowledge of the instantaneous value of $g[i]$ but the transmitter does not. Find the Shannon capacity of this channel.

Course Outcome 4 (CO4):

1. A Binary wave uses on – off signaling to transmit symbols 1 and 0. The symbol 1 is represented by a rectangular pulse of amplitude A and duration T_b sec. The additive noise at the receiver input is white and Gaussian with zero mean and Power spectral density $N_0/2$. Assuming that symbols 1 and 0 occur with equal probability. Analyze the BER performance of this system.
2. Consider a voice system with acceptable BER when the received signal power is at or above half its average value. If the BER is below is acceptable level for more than 120ms, users will turn off their phone. Find the range of Doppler values in a Rayleigh fading channel such that the average time duration when users have unacceptable voice quality is less than $t = 60ms$.
3. Design a digital modulation schemes which can support a BER of 10^{-2} at a SNR of 10dB. Derive the probability of error of the modulation scheme.

Course Outcome 5 (CO5):

1. Give the sampled signal models of SIMO and MISO systems, assuming that the channel is slow and flat frequency fading.
2. Consider a channel matrix of 4 x4 MIMO system. What is the multiplexing gain of each of channel, i.e., how many independent scalar data streams can be supported reliably?

$$H = \begin{bmatrix} -1 & -1 & 1 & 1 \\ -1 & 1 & 1 & -1 \\ -1 & -1 & -1 & -1 \\ -1 & 1 & -1 & 1 \end{bmatrix}$$

3. State true or false : Justify your answer
- Channel knowledge at the transmitter is not required in MIMO channels to extract multiplexing gain.
 - Channel knowledge at the transmitter is required in MIMO channels to extract diversity gain

Course Outcome 6 (CO6):

1. It is known that OFDM system converts a frequency selective fading channel into a set of parallel flat fading channel. Justify this statement with the assumption that the data $\tilde{s} = [1, -1, 1, -1]$ is to be transmitted through a frequency selective fading channel $g = [0.5, 0.25]$.
2. Derive expressions for ML estimation of time and frequency offset in OFDM system. The received signal model is given by $r(k) = s(k - \tau) \exp(j2\pi\epsilon k / N) + n(k)$. τ is the integer valued unknown arrival time of OFDM symbol and ϵ is normalized frequency offset. It is assumed that $2N + L$ consecutive samples are observed. N is number of subcarriers in OFDM symbol and L is length of cyclic prefix.
3. Compare OFDMA and SC-FDMA Systems.

Course Outcome 7 (CO7):

1. A voice of bandwidth 3 KHz is to be transmitted over a wireless link. The wireless link can support a data rate of 4Kbps. Design a wireless communication transceiver to transmit the voice. The required bit error rate is 10^{-6} at 8.9dB
2. A video of bandwidth 6MHz is to be transmitted over a wireless link. The wireless link can support a data rate of 1.5M samples/sec. Design a wireless communication transceiver to transmit the voice.
3. A audio of bandwidth 6KHz is to be transmitted over a wireless link. The wireless link can support a data rate of 16Kbps. Design a wireless communication transceiver to transmit the audio.

Concept Map

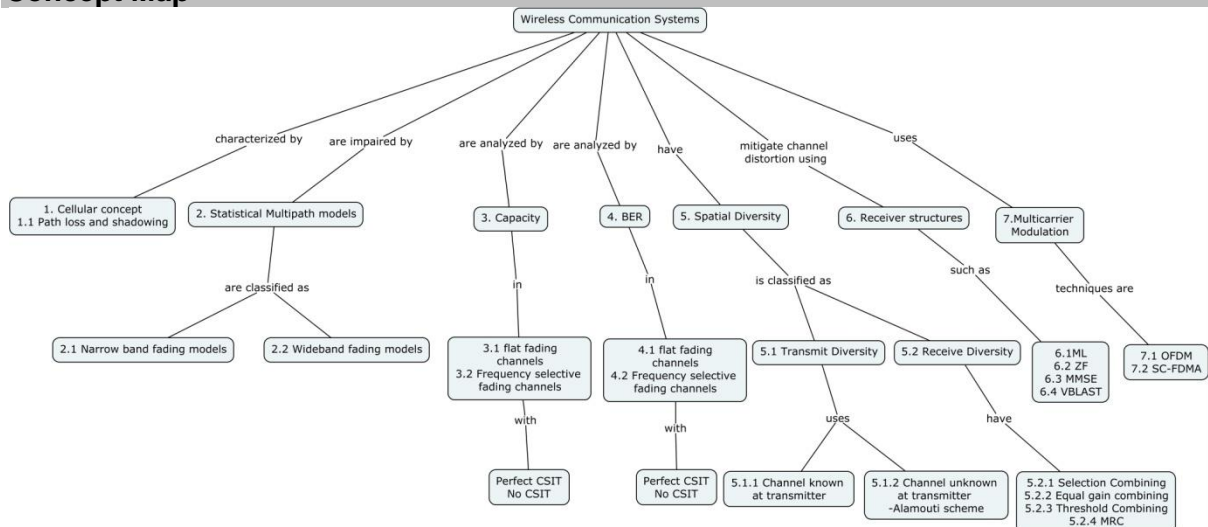

Syllabus

Wireless Fundamentals: Cellular concept, Path loss and shadowing: Radio Wave Propagation, Transmit and Receive Signal Models, Free-Space Path Loss, Ray Tracing, Empirical Path Loss Models, Simplified Path Loss Model, Shadow Fading, Combined Path Loss and Shadowing **Statistical Multipath Models:** Time-Varying Channel Impulse Response, Narrowband Fading Models, Wideband Fading Models **Capacity Analysis:** Capacity of Flat fading Channels, Channel and system model, Channel Distribution Information(CDI) Known, Channel Side Information at Receiver, Channel Side Information at transmitter and receiver, Capacity of frequency selective fading Channels, Time Invariant Channels, Time varying Channels **BER Analysis:** Digital Modulation and Detection: Signal Space analysis, Pass band modulation principles, Amplitude and Phase Modulation, Frequency modulation, Pulse shaping, Error probability analysis in fading channels **Spatial Diversity:** Transmit Diversity: Channel known at transmitter, Channel unknown at transmitter- Alamouti scheme, Receive Diversity: Selection combining, Equal Gain combining, Threshold Combining, Maximal Ratio Combining, Spatial Multiplexing in MIMO, Moment Generating functions in diversity analysis **Receiver structures:** Maximum Likelihood Receiver, Zero forcing receiver, Minimum Mean Square Error Receiver, V-BLAST Receiver **Multi Carrier Modulation:** Multi carrier concept, Orthogonal Frequency Division Multiplexing (OFDM) basics, Multiple access for OFDM systems, Orthogonal Frequency Division Multiple Access (OFDMA), Single Carrier Frequency Division Multiple Access (SC-FDMA).

Text Book

1. Andrea Goldsmith, "Wireless Communications", Cambridge University Press, 2005
2. Aditya.K.Jegannatham, "Principles of Modern Wireless Communication Systems", Tata McGraw Hill, 2016.

Reference Books

1. David Tse and Pramod Viswanath, "Fundamentals of Wireless Communications", Cambridge University Press, 2006.
2. Rias Muhamed, Jeffrey G.Andrews, Jun Zhang, Arunaba Ghosh, "Fundamentals of LTE", Prentice Hall, 2010.
3. A.Paulraj, R. Nabar and D Gore, "Introduction to Space-Time Wireless Communications", Cambridge University Press, 2003.
4. John G. Proakis, "Digital Communications", McGraw Hill, 2000.

Course Contents and Lecture Schedule

Module No.	Topic	No. of Lectures/Tutorial
1	Wireless Fundamentals	
1.1	Cellular concept	1
1.2	Path loss and shadowing: Radio Wave Propagation	1
1.3	Transmit and Receive Signal Models	1
1.4	Free-Space Path Loss	1
1.5	Ray Tracing	1
1.6	Empirical Path Loss Models	1
1.7	Simplified Path Loss Model	1
1.8	Shadow Fading	1
1.9	Combined Path Loss and Shadowing	1
2	Statistical Multipath Models	
2.1	Time-Varying Channel Impulse Response	1
2.2	Narrowband Fading Models	1
2.3	Wideband Fading Models	1

3	Capacity Analysis	
3.1	Capacity of Flat fading Channels.	1
3.2	Channel and system model	1
3.3	Channel Distribution Information(CDI) Known	1
3.4	Channel Side Information at Receiver	1
3.5	Channel Side Information at transmitter and receiver	1
3.6	Capacity of frequency selective fading Channels	1
3.7	Time Invariant Channels, Time varying Channels.	1
4	BER Analysis	
4.1	Digital Modulation and Detection: Signal Space analysis	1
4.2	Pass band modulation principles	1
4.3	Amplitude and Phase Modulation	2
4.4	Frequency modulation	1
4.5	Pulse shaping	1
4.6	Error probability analysis in fading channels	2
5	Spatial Diversity	
5.1	Transmit Diversity: Channel known at transmitter	1
5.2	Channel unknown at transmitter- The Alamouti scheme	1
5.3	Receive Diversity: Selection combining	1
5.4	Equal Gain combining	1
5.5	Threshold Combining	1
5.6	Maximal Ratio Combining	1
5.7	Spatial Multiplexing in MIMO	2
5.8	Moment Generating functions in diversity analysis	1
6	Receiver structures	
6.1	Maximum Likelihood Receiver	1
6.2	Zero forcing receiver	1
6.3	Minimum Mean Square Error Receiver	1
6.4	V-BLAST Receiver	1
7	Multicarrier Modulation	
7.1	The multicarrier concept	1
7.2	Orthogonal Frequency Division Multiplexing (OFDM) basics	2
7.3	Multiple access for OFDM systems	2
7.4	Orthogonal Frequency Division Multiple Access (OFDMA)	1
7.5	Single Carrier Frequency Division Multiple Access (SC-FDMA)	2
	Total	48

Course Designers:

1.	Dr.S.J.Thiruvengadam	sjtece@tce.edu
2.	Dr.G.Ananthi	gananthi@tce.edu

15EC630	ANTENNA AND WAVE PROPAGATION	Category	L	T	P	Credit
		PC	2	1	0	3

Preamble

In the era of multimedia, Internet, Web-world, Mobile and Bluetooth, communication is becoming wireless. Antennas are important component in making wireless communication a reality. This course is essential to understand the fundamental principles of Antenna theory, and wave propagation with a lucid explanation of the basic concepts and equations. The primary objectives of Antenna and Wave Propagation are to carry information from source to destination and also to understand the basic theory of electromagnetic waves propagation from transmitter to receiver. This course explains how antenna converts the electric and magnetic energy in to a propagating wave and vice versa. This course also explains the various types of transmitting and receiving antennas including arrays which are used for conventional broadcasting and antennas such as helix, spiral, fractal antennas used for wireless applications. The course introduces simple design procedures for popular antennas.

One of the main competencies that a present day communication engineer has to acquire is the capability to design antennas for wireless applications that provide good bandwidth and gain.

Prerequisite

15EC431: RF Transmission Lines and Passive circuits

Course Outcomes

On the successful completion of the course, students will be able to

CO1. Explain the process of radiation from an open ended transmission line	Understand
CO2. Explain the behaviour of an antenna in terms its parameters	Understand
CO3. Compute the fields and radiation resistance of a family of antenna & array	Apply
CO4. Select appropriate antenna for a given applications (TV, radar, wireless)	Apply
CO5. Design dipole, Yagi and patch antenna for a given specification	Analyze

Mapping with Programme Outcomes

COs	PO	PO	PO	PO	PO	PO	PO	PO	PO	PO	PO	PO	PSO	PSO	PSO	
	1	2	3	4	5	6	7	8	9	10	11	12	1	2	3	
CO1	M	L	-	-	-	-	-	-	-	-	-	-	-	-	-	-
CO2	M	L	-	-	-	-	-	-	-	-	-	-	-	-	-	-
CO3	S	M	L	-	-	-	-	-	-	-	-	-	M	-	-	-
CO4	S	M	L	-	-	-	-	-	M	M	L	L	M	L	-	-
CO5	S	M	L	L	L	-	-	M	M	-	-	L	L	L	-	-

S- Strong; M-Medium; L-Low

Assessment Pattern

Bloom's Category	Continuous Assessment Tests			Terminal Examination
	1	2	3	
Remember	20	20	0	0
Understand	40	30	40	40
Apply	40	40	40	40
Analyze	0	10	20	20
Evaluate	0	0	0	0
Create	0	0	0	0

Course Level Assessment Questions

Course Outcome (CO1)

1. Define Pattern multiplication
2. Define Maximum usable frequency
3. What are the applications of loop antenna?
4. Obtain the expression for radiated field and draw the pattern for a two element array of isotropic source with equal amplitude, phase shift 180° and element spacing $\lambda/4$.

Course Outcome (CO2)

1. What is polarization of antenna? Does it depend on the respective RF source?
2. Why loop antennas are called as magnetic dipole?
3. Compare the performance of broadside array and end fire array?
4. Why high-gain antennas are normally used for EME (moon bounce) communications?

Course Outcome (CO3)

1. In a radio link, two identical antennas operating at 8GHz are used with power gain of 50db, If the transmitted power is 2.5KW, find the received power for the range of link of 40km.
2. Two identical vertical radiator are spaced ' $d = \lambda/2$ ' meters apart and fed with currents of equal magnitude but with a phase difference ' β '. Evaluate the resultant radiation for the cases: (a) $\beta = 0^\circ$ (b) $\beta = -90^\circ$ (c) $\beta = +90^\circ$ the and propose the phase condition for making the array as broadside array.
3. A two element end-fire array in free space consists of 2 vertical side by side $\lambda/2$ elements with equal out of phase currents. At what angles in the horizontal plane is the field intensity maximum (a) when the spacing is $\lambda/2$? (b) when the spacing is λ

Course Outcome (CO4)

1. How does the earth affect ground wave and space wave propagation?
2. How are VHF signals propagated within the range of the visible horizon?
3. Radio waves projected towards the atmosphere do not return if the frequency is raised above a particular frequency which also changes with the angle of projection. Explain with neat diagram.

Course Outcome (CO5)

1. Design an Aluminium rod dipole antenna operating in the frequency of 100.4MHz.
2. Design a log periodic antenna to operate from 100-500MHz with 11 elements. Give (a) the length of longest element (b) length of shortest element and (c) gain
3. Design a Yagi Uda six element antenna for operation at 500MHz with a folded dipole feed. (a) What is the dimension of the parasitic elements in the antenna (b) frequency band width?

Concept Map

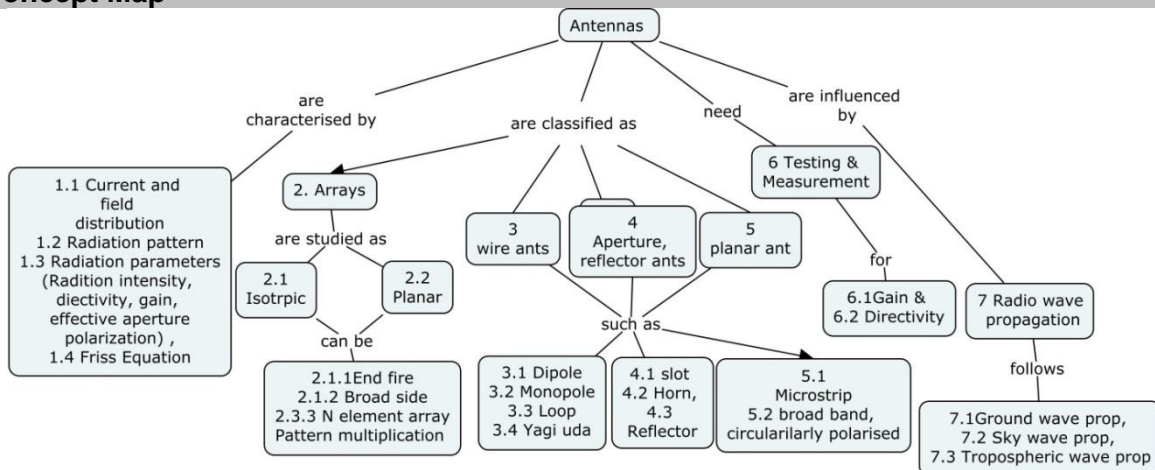

Syllabus

Antenna fundamental and Characteristics: Radiation mechanism- single wire, two wire, dipole. Types of Antennas: Wire antennas, aperture and reflector antennas, planar antennas and array antennas.. Antenna parameters: VSWR, Radiation pattern and principle cuts, Radiation power density and intensity ,Solid angle and beamwidth, directivity, efficiency, gain , polarization-types and axial radio, effective aperture, antenna temperature.

Antenna array and synthesis: Two element isotropic array –broadside, end-fire, pattern, multiplication, n-element linear array, uniform spacing and amplitude, tapering of antennas.

Wire antennas :Infinitesimal dipole, half wave length dipole and loop, monopole antenna – Image theory, Yagi antenna

Aperture and Reflector Antennas: Concept of aperture antenna: Babinet Principle- Slot antenna. Horn Antennas: E and H plane horns, Pyramidal horn: Design equations and problems, Circular polarized Double Ridged horn . Reflector antennas-Parabolic reflectors, Types of feeding, TV and Satellite Antennas, Gain problems.

Planar Antennas: Microstrip patch antennas, types, feeding mechanism, design equations and problems, advantages and limitations, Broadbanding techniques-Dielectric variations and Parasitic patches. Circular polarized patch antennas: Concept, Dual feed designs, Single feed designs, Circular and slot based patches, Design of a patch antenna for GNSS applications.

Antenna measurements: Antenna measurements- Measurement system, Anechoic chamber, Radiation pattern, Gain and directivity measurement

Radio wave propagation: Structure of atmosphere, Mode of propagation, Ground wave propagation, Reflection, diffraction, Ionospheric propagation, Electrical properties, Effects of Earths magnetic field. Friss formula and Channel Sounding Measurements – Base station and link budget problems.

Text Books:

1. C. A. Balanis, "Antenna Theory and Design", 3rd Ed., John Wiley & Sons., 2005.
2. A.R. Harish and M.Sachidananda, "Antenna and wave propagation", Oxford University Press., 2007.

Reference Books:

1. John D.Kraus, "Antennas", Tata McGraw Hill ,2002
2. W. L. Stutzman, and G. A. Thiele, "Antenna Theory and Design", 2nd Ed., John Wiley & Sons., 1998.
3. C. A. Balanis, "Antenna Theory and Design", 4th Ed., John Wiley & Sons., 2016.
4. F.E.Terman, "Electronic and Radio Engineering", Mc Graw Hill, 1985.

Course Contents and Lecture Schedule

Module No	Topics	No. of Lectures
1	Antenna fundamental and Characteristics:	
1.1	Introduction to PO, CO of the course, overview of the course	1
1.2	Classification of Antennas: Wire antennas, aperture and reflector antennas, planar antennas and array antennas	1
1.3	Radiation mechanism- single wire, two wire, dipole	1
1.4	Antenna parameters :VSWR, Radiation pattern and principle cuts	1
1.5	Radiation power density and intensity ,Solid angle and beam width, directivity, efficiency, gain	1
1.6	polarization-types and axial radio, effective aperture, antenna temperature	1
1.7	Tutorial	3
2	Antenna Array and Synthesis:	
2.1	Two element isotropic array -broadside, end-fire,	2
2.2	Pattern multiplication and applications	1
2.3	N element linear array-uniform spacing and amplitude	1
2.4	Tapering of arrays,	1

2.5	Tutorial	2
3	Wire antenna	
3.1	Infinitesimal dipole, half wave length dipole	2
3.2	loop, monopole antenna	1
3.3	Image theory, Yagi antenna	1
4	Aperture and Reflector Antennas	
4.1	Concept of aperture antenna: Babinet Principle- Slot antenna Design equations and problems,	2
4.2	Horn Antennas: E and H plane horns, Pyramidal horn: Circular polarized Double Ridged horn	2
4.3	Reflector antennas-Parabolic reflectors	1
4.4	Types of feeding, TV and Satellite Antennas, Gain problems.	1
4.5	Tutorial	3
5	Planar Antennas	
5.1	Microstrip patch antennas, types, feeding mechanism, design equations and problems, advantages and limitations,.	1
5.2	Broadbanding techniques-Dielectric variations and Parasitic patches	2
5.3	Circular polarized patch antennas: Concept, Dual feed designs, Single feed designs,	1
5.4	Circular and slot based patches,	1
5.5	Design of a patch antenna for GNSS applications	1
5.6	Tutorial	2
6	Radio Wave propagation	
6.1	Structure of atmosphere, Mode of propagation	1
6.2	Ground wave propagation, Reflection, diffraction,	1
6.3	Tropospheric propagation	1
6.4	Ionospheric propagation, electrical properties,	1
6.5	Effects of Earths magnetic field.	1
6.5	Friss formula and Channel Sounding Measurements – Base station and link budget problems.	1
6.6	Tutorial	1
7	Antenna measurements	
7.1	Measurement system, Anechoic chamber, Radiation pattern, Gain and directivity measurement	2
7.2	Tutorial/ Miniproject	2

Course Designers:

1	Dr.V.Abhaikumar	principal@tce.edu
2.	Dr.B.Manimegalai	naveenmegaa@tce.edu

14EC670	PROFESSIONAL COMMUNICATION	Category	L	T	P	Credit
		PC	1	0	1	2

Preamble

This course provides opportunities to students to develop and demonstrate basic communication skills in technical, professional and social contexts effectively.

Prerequisite

Nil

Course Outcomes

On the successful completion of the course, students will be able to

S.No	Course Outcomes	Bloom'sLevel
CO1	Plan, organise, write, and present project reports, and technical papers in the frame of the scientific method	Apply
CO2	Establish themselves through communication skills in corporate environment	Apply
CO3	Solve verbal aptitude questions related to placement and higher studies	Apply
CO4	Apply their interpersonal skills in technical, professional and social contexts	Apply

Assessment Pattern

Internal

No Common Continuous Assessment Test (CAT) will be conducted.

Students' performance will be continuously assessed in various classroom activities in Listening, Speaking, Reading and Writing for 50 marks as detailed below

Project Report Preparation and Technical Presentation through PPT	-	15
Listening Test	-	10
Spoken Task – Group Discussion / Mock Job Interview	-	10
Writing – Verbal Aptitude for Placement and Higher studies-		15
(The test will be conducted for 50 marks and reduced to 15)		

External (Practical)

Listening Test	-	20
Group Discussion	-	25
Personal Interview / Situational Conversation	-	25
Technical Presentation	-	20
Resume Submission	-	10

List of Experiments

Sl. No.	Topic	No. of Hours	
		Theory	Practical
1	Literature Survey / Project Title Selection	1	-
2	Characteristics of Technical Paper and Project Report	1	-
3	Abstract / Data Presentation	1	--
4	Common Errors in Technical Writing	1	-

5	Bibliography and References	1	-
6	Vocabulary Development	1	-
7	Sentence Completion	1	-
8	Error Spotting	1	-
9	Interpretation of Verbal Analogy	1	-
10	Interpretation of Reading (Comprehension - Conception)	1	-
11	Interpretation of Reading (Comprehension - Reasoning)	1	-
12	Practice for writing E-mails	1	-
13	PPT Preparation /Demonstration of Technical Presentation	-	4
14	Preparation of Resume	-	2
15	Preparation for Job Interviews	-	4
16	Demonstration of Group Discussion Skills	--	4
17	Developing Listening Skill (Comprehension)	-	3
18	Practice for Short Speeches / Situational Conversation	-	4
19	Development of Employability Skills	-	2
20	Non-Verbal Communication	-	1
Total Hours		12	24

Reference Books:

1. Courseware on "Technical Communication for Scientists and Engineers", IIT Bombay, 2015.
2. Cappel, Annette and Sharp, Wendy, Cambridge English: Objective First, 4th Ed., CUP, New Delhi, 2013.
3. Sue Prince, Emma, The Advantage: The 7 Soft Skills You Need to Stay One Step Ahead, Pearson; 1 Edition, 2013.
4. Cusack, Barry. Improve Your IELTS Listening and Speaking Skills (With CD) Paperback, Macmillan, 2007.
5. Bates, Susan TOEFL iBT Exam Paperback – oxford, 2012 .
6. Hart, Guy Brook. Cambridge English Business Benchmark: 2 Ed., CUP 2014

Course Designers:

1.	Dr. S.Rajaram	sreng@tce.edu
2	Dr.A.TamilSelvi	tamilselvi@tce.edu
3	Mr.R.Vinoth	vino@tce.edu
4.	Dr.R.K.Jaishree Karthiga	jai@tce.edu

14EC680	MICROWAVE AND ANTENNA LAB	Category	L	T	P	Credit
		PC	0	0	1	1

Preamble

The objective of this course is to design, simulate and experiment the characteristics of microwave planar transmission lines, passive devices and antennas.

Prerequisite

14EC430 Transmission lines and Waveguides (or) 15EC431 RF Transmission Lines and Passive Circuits

Course Outcomes

On the successful completion of the course, students will be able to

CO1	Design and simulate the characteristics of planar transmission lines	Apply
CO2	Design, simulate and test the characteristics of microwave passive devices such as power divider, coupler, filter	Apply
CO3	Design and simulate the characteristics of microstrip antennas	Apply
CO4	Measure the radiation characteristics of microwave antennas	Apply
CO5	Experiment wireless path loss	Apply

Mapping with Programme Outcomes

COs	PO 1	PO 2	PO 3	PO 4	PO 5	PO 6	PO 7	PO 8	PO 9	PO 10	PO 11	PO 12	PSO 1	PSO 2	PSO 3
CO1	S	M	L	-	M	-	-	-	L	-	-	L	S	-	-
CO2	S	M	L	-	M	-	-	-	L	-	-	L	S	-	-
CO3	S	M	L	-	M	-	-	-	L	-	-	L	S	-	-
CO4	S	M	L	-	M	-	-	-	L	-	-	L	S	-	-
CO5	S	M	L	-	M	-	-	-	L	-	-	L	S	-	-

S- Strong; M-Medium; L-Low

Syllabus

1. Design, Simulation and measurement of Planar transmission lines – Microstripline, Stripline, CPW lines.
2. Design, Simulation and testing of passive microwave devices such as Power divider, Coupler, Filter and Planar antenna
3. Measurement of Radiation pattern and Gain of Wire and planar antennas
4. Measurement of Radiation pattern and Gain of Horn antenna
5. Measurement of Radiation pattern and Gain of VSAT antenna
6. Testing of antennas and microwave devices with spectrum and network analyser

Course Designers:

1. Dr(Mrs).S.Raju rajuabhai@tce.edu
2. Mr.K.Vasudevan kvasudevan@tce.edu

14EC690	SYSTEM DESIGN AND TESTING LAB	Category	L	T	P	Credit
		PC	0	0	1	1

Preamble

The purpose of this course is to emphasize the practical issues of the Wireless system board and measure the parameters of different modules of wireless system board.

Prerequisite

14EC430 Transmission lines and Waveguides (or) 15EC431 RF Transmission Lines and Passive Circuits

Course Outcomes

On the successful completion of the course, students will be able to

CO1	Experiment the operation of WLAN wireless board	Apply
CO2	Measure the parameters for different RF subsystem	Apply
CO3	Measure the parameters of embedded system	Apply
CO4	Measure the parameters of base band system	Apply
CO5	Evaluate the performance of different wireless boards	Evaluate

Mapping with Programme Outcomes

COs	PO 1	PO 2	PO 3	PO 4	PO 5	PO 6	PO 7	PO 8	PO 9	PO 10	PO 11	PO 12	PSO 1	PSO 2	PSO 3
CO1	S	M	L	-	M	-	-	-	L	-	-	M	S	-	-
CO2	S	M	L	-	M	-	-	-	L	-	-	M	S	-	-
CO3	S	M	L	-	M	-	-	-	L	-	-	M	S	-	-
CO4	S	M	L	-	M	-	-	-	L	-	-	M	S	-	-
CO5	S	S	S	-	M	-	-	-	L	-	-	M	S	L	-

S- Strong; M-Medium; L-Low

List of Experiments

1. Functional verification of Wireless Chipsets and tool chains
2. Testing of embedded peripherals of wireless system (PLL)
3. Performance measurement of mixed signal peripherals of wireless (ADC/DAC)
4. Testing and measurement of Baseband parameters of wireless board such as Bit Error Rate and throughput,
5. Testing and measurement of Baseband parameters such as eye pattern and Error Vector Magnitude
6. Testing and measurement of RF parameters such as Output Power, Noise Figure, spectral masking, Inter-modulation Products and Spur – Spurious
7. Evaluation of wireless boards such as WLAN, Zigbee, NI USRP

Course Designers:

- | | |
|---------------------|--|
| 1. Dr(Mrs).S.Raju | rajuabhai@tce.edu |
| 2. Dr.B.Manimegalai | naveenmegaa@tce.edu |
| 3. Dr.K.Hariharan | khh@tce.edu |
| 4. Dr.M.N.Suresh | mns@tce.edu |
| 5. Dr.A.Thenmozhi | thenmozhi@tce.edu |

CURRICULUM AND DETAILED SYLLABI

FOR

SEVENTH SEMESTERS

B.E. DEGREE PROGRAMME

IN
ELECTRONICS AND COMMUNICATION ENGINEERING



FOR THE STUDENTS ADMITTED IN THE

ACADEMIC YEAR 2014-15 ONWARDS

DEPARTMENT OF ELECTRONICS AND COMMUNICATION ENGINEERING

THIAGARAJAR COLLEGE OF ENGINEERING

(A Government Aided ISO 9001:2008 certified Autonomous Institution affiliated to Anna University)

MADURAI – 625 015, TAMILNADU

Phone: 0452 – 2482240, 41

Fax: 0452 2483427

Web: www.tce.edu

14EC710	ACCOUNTING AND FINANCE	Category	L	T	P	Credit
		HSS	3	0	0	3

Preamble

Engineering profession involves lots of decision making. The decisions may range from operation to non-operation. For taking decisions of these kinds, an engineer needs among other data about the organization routine operations and non-routine operations. Accounting is a science which provides all the data by recording, classifying, summarizing and interpreting the various transactions taking place in an organization and thereby helps an engineer in taking vital decisions in an effective manner. Finance is an allied but a separate field relying on accounting and enables engineers in taking useful financial and cost related decisions by providing well defined concepts, tools and techniques.

Prerequisite

Nil

Course Outcomes

On the successful completion of the course, students will be able to

CO1	Explain the basic concepts and process of accounting and finance.	Understand
CO2	Develop trail balance and financial statements like Trading, Profit and Loss accounts, Balance sheet and Cost sheet	Apply
CO3	Demonstrate the concepts and operations of budgetary control	Understand
CO4	Apply techniques like breakeven analysis and budgeting for an organization.	Apply
CO5	Select the right sources of finance and mobilize the right quantum of finance and make use of them in most profitable investment avenues.	Apply

Mapping with Programme Outcomes

COs	PO 1	PO 2	PO 3	PO 4	PO 5	PO 6	PO 7	PO 8	PO 9	PO 10	PO 11	PO 12	PSO 1	PSO 2	PSO 3
CO1	M												-	-	-
CO2	S	M	M		M	M		M			S	L	M	-	S
CO3	M					M					M		-	-	M
CO4	S	M	M		S	M		M		L	S	L	M	-	S
CO5	S	M	M			M					S	L	M	-	S

S-Strong; M-Medium; L-Low

Assessment Pattern

Bloom's Category	Continuous Assessment Tests			Terminal Examination
	1	2	3	
Remember	20	20	20	20
Understand	30	30	30	30
Apply	50	50	50	50
Analyze	0	0	0	0
Evaluate	0	0	0	0
Create	0	0	0	0

Course Level Assessment Questions**Course Outcome 1 (CO1):**

1. Describe the term Accounting.
2. List the concepts of accounting.
3. Recall the methods of depreciation.
4. Name the factors causing depreciation.
5. Write the classification of cost.
6. Define the term capital budgeting.

Course Outcome 2 (CO2):

1. Prepare trading account from the information given below and calculate the net profit. Gross profit....Rs.10,000; Office and administrative expensesRs.1000; selling and distribution expensesRs.500; Interest on investment received...Rs.500; commission received....Rs.200
2. Compare Trading and profit and loss account. Compute depreciation for an asset worth Rs.10,000 and having a scrap value of Rs.2,000 and a life time of 4 years under straight line method.
3. Outline the cost classification based on the nature of cost.
4. Apply the net present value method of evaluating investment decision and say whether the following project could be selected for investment.

Year	Cash inflows in Rs.
0	10,000
1	3,000
2	4,000
3	4,000
4	2,000
5	2,000

Course Outcome 3

1. Construct journal entries for the following business transactions.
 - X brings in cash Rs.10,000 as capital
 - Purchases land worth Rs.2000
 - He purchases goods worth Rs.5,000
 - He sells goods for Rs.10,000
 - He incurs travelling expenses of Rs.200.
2. Estimate Gross profit and Net profit and the financial position from the following trial balance extracted from the books of Mr.Kumar as on 31.12.2010.

Debit Balances	Amount in Rs.	Credit Balances	Amount in RS.
Buildings	30,000	Capital	40,000
Machinery	31,400	Purchase returns	2,000
Furniture	2,000	Sales	2,80,000
Motor car	16,000	Sundry creditors	9,600
Purchases	1,88,000	Discounts received	1,000
Sales return	1,000	Provision for bad debts	6,00
Sundry debtors	30,000		
General expenses	1,6000		
Cash at bank	9,400		
Rates and taxes	1,200		
Bad debts	4,00		
Insurance premium	8,00		
Discount allowed	1,400		
Opening stock	20,000		
Total	3,33,200	Total	3,33,200

- Calculate depreciation for a machinery purchased by senthil for Rs.4,00,000 on 1st April 2010.He also adds an additional machinery for Rs.40,000 on 1st April 2011.Depreciation is to be provided at 10% per annum using straight line method. The firm closes its books on 31st March every year.
- A factory is currently working at 50% capacity and the product cost is Rs.180 per unit as below:

MaterialRs.100; Labour.....Rs.30 Factory overheads....Rs.30 (40% fixed)
Administration overhead .Rs.20 (50% fixed)

The product is sold at Rs.200 per unit and the factory produces 10,000 units at 50% capacity. Estimate profit if the factory works to 60% capacity. At 60% working raw material increases by 20% and selling price falls by 20%.

Course Outcome 4

- From the following information calculate the Breakeven point in terms of units and breakeven point in terms of sales.
Sales....Rs.10,000; Variable costs Rs.6,000,fixed costs Rs.2000;profit Rs.2,000;No. Of units produced 1,000 units
- Describe the term ‘ Breakeven analysis’
- Calculate the breakeven point and margin of safety from the following information
Fixed cost ...Rs.10,000, sales in Rs.25,000,selling price per unit Rs.30; variable cost per unit Rs.10

Concept Map

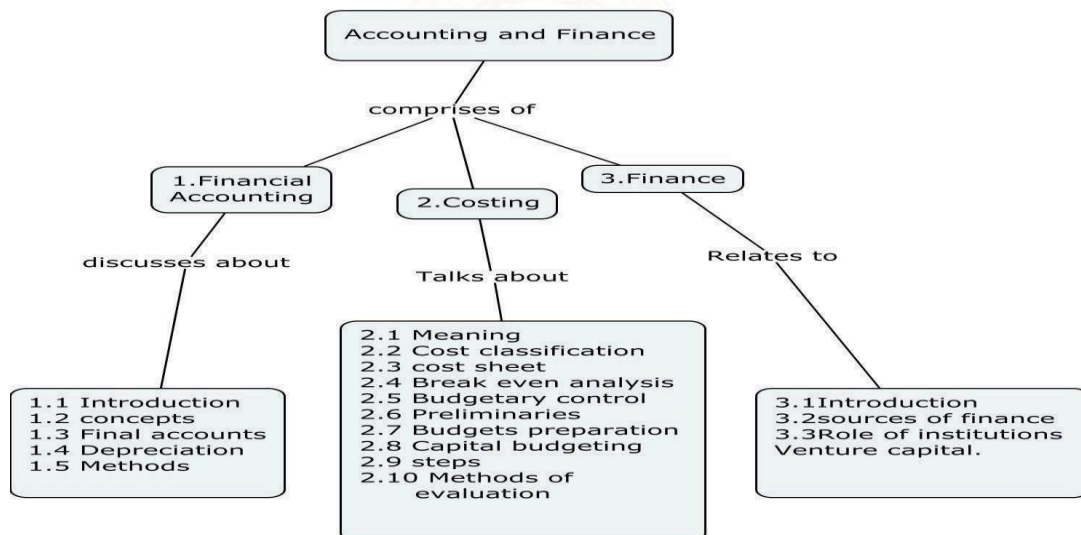

Syllabus

Accounting: Introduction and Definition- Accounting concepts and conventions-Final Accounts-Preparation of Trading, Profit and Loss Account and Balance Sheet. Depreciation - Meaning-Need and objectives-Basic factors-Methods of providing depreciation.

Cost Accounting: Meaning and Importance-Cost-Elements of cost- Cost classification- Preparation of cost sheet. Break even analysis-Manual applications. Budget and budgetary control. Meaning- Objectives of budgetary control-Preliminaries

for operation of budgetary control-Budgets-Types of budgets and their preparation. Capital budgeting- Meaning-Importance-steps in capital budgeting-Information needed-Methods of evaluating capital budgeting decisions.

Finance: Introduction-Definition-objectives-functions of finance-sources of finance-Short- term, Medium term, and Long-term-Role of special financial institutions in financing-Venture capital.

Text Books

1. M.C.Shukla,T.S.Grewal,“AdvancedAccounts-Volume-I,2010 Reprint, S. Chand & companyLtd.,2010.
2. Prasanna Chandra, “Financial Management-Theory and practice” seventh Reprint, Tata McGraw-Hill publishing company Limited,2010.

Reference Books

1. A.Ramachandra Aryasri, V.V Ramana Murthy, “Engineering Economics and Financial Accounting, Tata McGraw Hill, 2010.
2. Dr.V.R.Palanivelu, “Accounting for Management” Third Edition, 2013, University Science Press New Delhi.

Course Contents and Lecture Schedule

Module No.	Topic	No. of Lectures
1.	Financial accounting	
1.1	Introduction and Definition	1
1.2	Accounting concepts and conventions	2
1.3	Final accounts-Preparation of Trading profit and Loss account and Balance sheet.	4
1.4	Depreciation- Meaning, Need and Objectives	2
1.5	Basic factors-Methods of providing depreciation	3
2.	Cost Accounting	
2.1	Meaning and Importance	1
2.2	Cost-Elements of cost-Cost classification	2
2.3	Preparation of cost sheet	2
2.4	Break even analysis-Managerial applications	2
2.5	Budget and budgetary control. Meaning- Objectives of budgetary control	1
2.6	Preliminaries for operation of budgetary control	1
2.7	Types of budgets and their preparation	3
2.8	Capital budgeting-Meaning-Importance	1
2.9	Steps in capital budgeting-Information needed	1
2.10	Methods of evaluating capital budgeting decisions. Payback period-Rate of Return-Net present value-Internal Rate of return method	3
3	Finance	
3.1	Introduction-Definition-objectives-functions of finance	2
3.2	sources of finance-Short-term, Medium term, and Long-term	2
3.3	Role of special financial institutions in financing- Venture capital.	3
	Total	36

Course Designers:

1.	S.Dhanasekaran	sdmech@tce.edu.
2.	P.S.Boopathy Manickam	psbmeco@tce.edu

14EC720	OPTICAL COMMUNICATION NETWORKS	Category	L	T	P	Credit
		PC	3	0	0	3

Preamble

The objective of this course is to provide a comprehensive understanding of optical communication systems and networks. This course provides coverage of basic optical technology including physical aspects of light propagation, fiber optic components and its characteristics and modulation/demodulation techniques and link design. It also covers enabling technologies for optical network including SONET/SDH, WDM network, access network and future optical systems and Networks.

Prerequisite

NIL

Course Outcomes

On the successful completion of the course, students will be able to

CO1	Comprehend the light propagation phenomenon inside the optical fiber and reasons behind channel impairments in various types of fibers.	Understand
CO2	Demonstrate the characteristics of various optical components and their use in optical communication network. (sources, detectors, couplers, isolators, multiplexers, switches, filters, etc.)	Apply
CO3	Understand the principal of operation of SONET, WDM network, access network and some future optical networking technologies.	Understand
CO4	Solve network survivability and wavelength routing and assignment problems in optical network.	Apply
CO5	Evaluate the performance of a fiber optic communication link.	Evaluate

Mapping with Programme Outcomes

COs	PO 1	PO 2	PO 3	PO 4	PO 5	PO 6	PO 7	PO 8	PO 9	PO 10	PO 11	PO 12	PSO 1	PSO 2	PSO 3
CO1	M	L	-	-	-	-	-	L	M	L	-	-	L	-	L
CO2	S	M	-	-	-	-	-	M	-	M	L	L	M	-	L
CO3	M	L	-	-	-	-	-	L	M	L	-	-	L	L	L
CO4	S	M	L	-	-	-	-	M	L	M	L	L	M	L	L
CO5	S	S	M	L	-	-	-	-	L	L	L	L	S	L	L

S- Strong; M-Medium; L-Low

Assessment Pattern

	Bloom's category	Continuous Assessment Tests (50)			End Semester Examinations
		1	2	3	
1	Remember	20	20	0	0
2	Understand	20	20	30	30
3	Apply	60	30	50	50
4	Analyze	0	0	0	0
5	Evaluate	0	30	20	20
6	Create	0	0	0	0

Course Level Assessment Questions**Course Outcome 1 (CO1):**

1. What are the advantages of optical fiber communication?
2. Why the attenuation of light signal is more near the wavelength of 1400nm?
3. What is the difference between intermodal and intramodal dispersion?
4. How does dispersion limit the performance of a fibre optic system?
5. An optical fiber has the following data: $n_1 = 1.5$, $n_2 = 1.45$. Calculate critical angle, numerical aperture and acceptance angle.

Course Outcome 2 (CO2):

1. A 1550-nm LED has an internal quantum efficiency η_{int} of 99% and external quantum efficiency η_{ext} of 20%. Calculate the output power P_{out} of the LED when it is driven by a current I of 80 mA.
2. A product sheet of a 2x2 biconical tapered coupler with 40:60 splitting ratio shows a insertion loss of 2.5 dB for 60 percent port and 4 dB for 40 percent port
 - a. If the input power $P_0 = 150 \mu\text{W}$, find the power at output port 1 and output port 2.
 - b. From the calculated output power P_1 and P_2 , show that the splitting ratio is 40:60.
 - c. Find the excess loss of the coupler.
3. Assume that wavelengths $\lambda_1 = 1530\text{nm}$, $\lambda_2 = 1534\text{nm}$, $\lambda_3 = 1538\text{nm}$ and $\lambda_4 = 1542\text{nm}$ are transmitted through an optical add drop multiplexer. Construct a fiber bragg grating based add drop multiplexer to drop wavelength λ_1 , λ_2 , λ_3 respectively at each stage and add wavelength λ_5 (1550nm) at the last stage by properly designing the grating period ($n_{eff} = 1.48$). Draw the OADM architecture.

Course Outcome 3 (CO3):

1. What are the advantages of second generation network?
2. Write down the features of SONET.
3. Define WRA problem.
4. List some future access network.

Course Outcome 4 (CO4):

1. Consider the network topology shown below. Each undirected link represents two fibers, one for the transmission in each direction. There are 4 end nodes and 2 hub nodes.

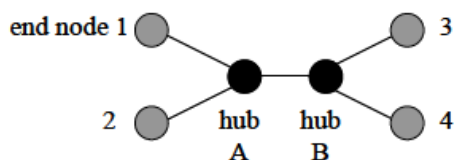

Consider the following s-d pairs each of which has 1 wavelength unit of traffic: 1-3, 1-4, 2-3, 2-4, 3-1, 3-2, 4-1, 4-2, 4-3. Specify the wavelength assignment (WA) that uses the minimum number of wavelengths.

2. Consider the network shown below. Assign wavelengths using first fit and random fit algorithm for the following lightpath requests: (i) C-F (ii) A-E (iii) H-E (iv) B-H (v) A-C (vi) G-B (vii) A-B.

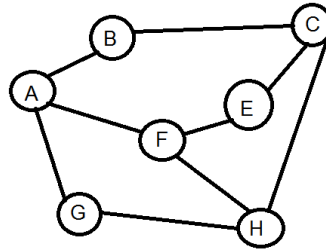

3. Consider a ring topology with 5 nodes. Find the ways by which the network can be protected against link failure.

Course Outcome 5 (CO5):

1. For an optical fiber link of 15km and B. W. of 100Mbps, receiver sensitivity is -50dBm, fiber loss is 2dB/km and power launch is 0dBm into the fiber by transmitter, detector coupling loss is 1dB and splicing loss of 0.4 dB/splice for 10 splices. Determine the feasibility of system.
2. A 100Mbit/s signal is to be sent through a 100m length of fiber with eight connector pairs to a receiver with sensitivity of -30dBm. The fiber loss is 4dB/km, and the average connector loss is 1.0dB. if the system margin is 5dB, what is the minimum power that the light source must launch into fiber?
3. For a digital optical fiber link of overall length 7 km and operating at a 20 M bit/s using an RZ code. A LED emitting at 0.85 μm with graded index fiber to a PIN photodiode is a suitable choice for the system components, giving no dispersion equalization penalty. An LED which is capable of launching an average of 100μ W of optical power [including connector loss into a 50μm core diameter graded index fiber is chosen]. The proposed fiber cable has an attenuation of 2.6 dB/km and requires splicing every km with a loss of 0.5 dB per splice. There is also a connector loss at the receiver of 1.5 dB. The receiver requires mean incident optical power of -41 dBm in order to give the necessary BER of 10⁻¹⁰, and it is predicted that a safety margin of 6 dB will be required. Write down the optical power budget for the system and hence determine its viability.
4. Consider an optical transmission system operating at a wavelength of 1550 nm over an unrepeated distance of 75km at the rate of 800 Mb/s. The transmitter available has a minimum coupled output power of 2mw, while the receiver has a worst case received power of 125μW. Two types of fibre with different specifications are available as shown in the table below. Two connectors are to be used in the system with a loss of 0.5 dB each, while the splice loss for both fibre types is 0.2 dB maximum. Assume a system margin of 3dB. Prepare a power budget for each system and decide which fibre type should be used and why.

Fibre type	Attenuation	Maximum distance between splices
A	0.5 dB/km	1500 metres
B	0.3 dB/km	1200 metres

Concept Map

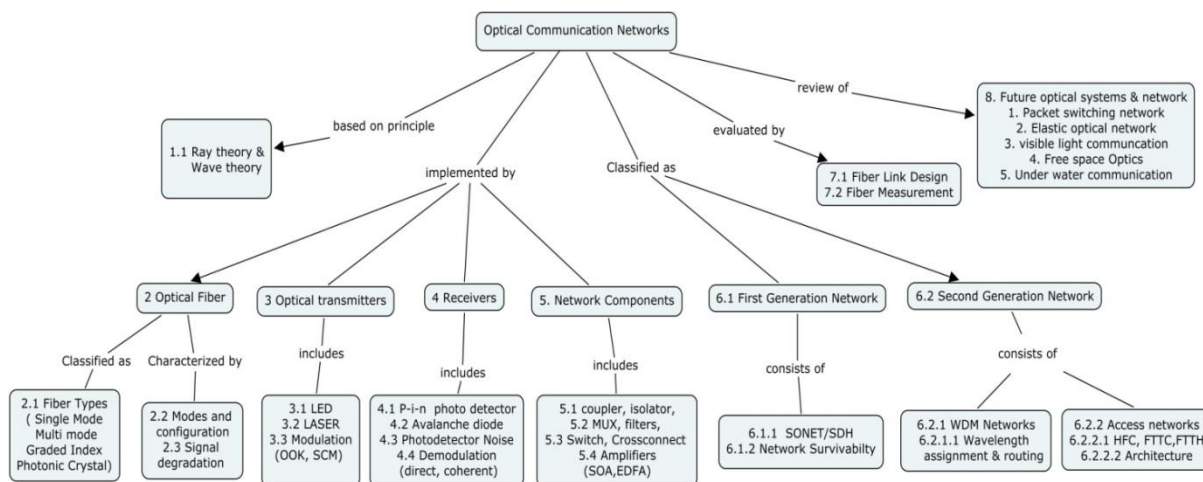

Syllabus

Introduction: Motivation and evolution of fiber optic system, Elements of optical fiber transmission link; Nature of light-wave theory, ray theory; light wave propagation

Optical Fibers: Types - single mode fiber, multi mode fiber, graded index fiber, photonic crystal fiber; Optical fiber modes and configurations, Signal degradation in optical fiber: Attenuation, Dispersion

Optical Transmitter: Light Emitting Diode - structure, quantum efficiency and power; Laser – laser diode mode and threshold condition, rate equation, quantum efficiency and resonant frequency; Modulation-OOK, SCM.

Optical Detectors: pin photo detector, Avalanche photodiode, Photo detector Noise; demodulation – Direct detection, coherent detection;

Optical Network Components: Coupler, Isolator, Multiplexers, Filters, Optical switches, Optical cross connects, Optical amplifiers: EDFA-SOA;

First generation optical network: SONET/SDH – multiplexing, physical layer, infra structure; Network survivability **Second Generation optical Networks:** WDM networks - Wavelength Assignment and Routing; Access Network: HFC, FTTC, FTTH, access network architecture

Fiber Optic Link Design: Digital Systems: Power budget, rise time budget; Analog systems

Fiber Measurements: Attenuation and Dispersion Measurement

Future Optical Systems & Networks: Packet switching network - Elastic optical network - visible light communication - Free space Optics - Under water communication

Text Book:

1. Gerd Kaiser, "Optical fiber communications", 5th ed. McGraw Hill Int., 2013.
2. Rajiv Ramaswami, Kumar Sivarajan, Galen Sasaki, "Optical Networks: a practical perspective", Morgan Kaufmann Publishers, 3rd ed., 2009.

Reference Books:

1. G.P. Agrawal, "Fiber-Optic Communication Systems", Wiley, 4th ed, 2010
2. John Senior, "Optical fiber communications-principles and practices", Prentice Hall of India, 3rd ed., 2013.
3. J.Gower, "Optical communication systems", Prentice Hall of India, 2001.
4. Joseph C. Palais, "Fiber Optic Communication", PEARSON EDUCATION, 5th ed, 2011.
5. Biswanath Mukherjee, "Optical WDM Network", Springer, 2006

Course Contents and Lecture Schedule

Module No	Topics	No. of Lectures
1	Optical Fiber Communication	
1.1	Motivation and evolution of fiber optic system, Elements of optical fiber transmission link	1
1.2	Nature of light: wave theory, ray theory – light wave propagation	1
2	Optical Fibers	
2.1	Fiber Types: Step index fiber, Graded index fiber, Single mode fiber, photonic crystal fiber	1
2.2	Optical fiber modes and configurations	1
2.3	Signal Degradation in optical fiber: Attenuation, Distortion, Design optimization of single mode fiber	2
3	Optical Transmitter	
3.1	Light Emitting Diode: structure, quantum efficiency and power	1
3.2	Laser: laser diode mode and threshold condition, rate equation, quantum efficiency and resonant frequency	2
3.3	Modulation : On Off Keying, Sub Carrier Multiplexing	1
4	Optical Receivers	
4.1	p-i-n photo detector - Avalanche photodiode	1
4.2	Photo detector Noise	1
4.3	Demodulation: Direct Detection, Coherent Detection	2
5	Optical Network Components	
5.1	Coupler, Isolator	2
5.2	Multiplexers, Filters	2
5.3	Switches, Cross connects	2
5.4	Optical Amplifiers	1
6.1	First Generation Optical Networks	
6.1.1	SONET/SDH – multiplexing, physical layer, infrastructure	2
6.1.2	Network Survivability	1
6.2	Second Generation Optical Networks	
6.2.1	WDM Networks	1
6.2.1.1	Wavelength Assignment and routing	2
6.2.2	Access network	
6.2.2.1	HFC, FTTC, FTTH	1
6.2.2.2	Network architecture	2
7.1	Fiber Optic Link Design	
7.1.1	Digital Systems: Power Budget , Rise time Budget	2
7.1.2	Analog systems	1
7.2	Fiber Measurements: Attenuation and Dispersion Measurement	1
8	Future Optical Systems & Networks	2
	1. Packet switching network	

	2. Elastic optical network 3. visible light communication 4. Free space Optics 5. Under water communication	
	Total	36

Course Designers:

1. Dr. S. Ponmalar
2. Mrs.E..Murugavalli

spmece@tce.edu
murugavalli@tce.edu



14EC770	ASIC DESIGN	Category	L	T	P	Credit
		PC	2	0	1	3

Preamble

14EC770 is a study of basic concepts of Digital CMOS Application Specific Integrated Circuit (ASIC) systems design. The course aims at ASIC physical design flow, including logic synthesis, floor-planning, placement and routing. Experiments explore complete digital design flow of programmable ASIC through VLSI EDA tools. Students work from design entry using verilog code to GDSII file generation of an ASIC.

Prerequisite

14EC520: Digital CMOS Systems

Course Outcomes

On the successful completion of the course, students will be able to

CO1	Describe the design flow, types and the programming technologies of an ASIC and its construction.	Understand
CO2	Describe the goals, objectives, measurements and algorithms of partitioning then apply those algorithms to partition the network to meet the objectives.	Apply
CO3	Describe the goals, objectives, measurements and algorithms of floorplanning & placement then apply those algorithms to place the logic cells inside the flexible blocks of an ASIC to meet the objectives.	Apply
CO4	Describe the goals, objectives, measurements and algorithms of routing then apply those algorithms to route the channels then describing various circuit extraction formats and Investigate the issues and discover solutions in each step of physical design flow of an ASIC.	Analyze
CO5	Design an ASIC for digital circuits with ASIC design flow steps consists of simulation, synthesis, floorplanning, placement, routing, circuit extraction and generate GDSII File for fabrication of an ASIC, then analyze the ASIC to meet the performance in terms of area, speed and power using EDA tools.	Analyze

Mapping with Programme Outcomes

COs	PO 1	PO 2	PO 3	PO 4	PO 5	PO 6	PO 7	PO 8	PO 9	PO 10	PO 11	PO 12	PSO 1	PSO 2	PSO 3
CO1	M	L	-	-	M	-	-	L	L	L	M	M	M	-	M
CO2	S	M	L	-	M	-	-	L	M	M	L	M	S	-	M
CO3	S	M	L	-	M	-	-	L	M	M	-	M	S	-	M
CO4	S	S	M	L	M	-	-	L	M	M	-	S	S	L	M
CO5	S	S	M	L	S	-	-	L	S	S	-	M	S	L	S

S- Strong; M-Medium; L-Low

Assessment Pattern

Bloom's Category	Continuous Assessment Tests			Terminal Examination
	1	2	3	
Remember	20	0	Practical	0
Understand	40	20		20
Apply	40	30		30
Analyse	0	50		50
Evaluate	0	0		0
Create	0	0		0

Course Level Assessment Questions**Course Outcome 1 (CO1):**

1. Give examples of ASIC and Non ASIC
2. Define cost function
3. Name two keywords used for automatic partition with FPGAs
4. Discuss the routing details of standard cell based ASIC
5. Describe the SRAM programming technology of an ASIC

Course Outcome 2 (CO2):

1. Define hill climbing
2. Name the iterative partitioning improvement algorithms.
3. Describe simulated annealing algorithm in partitioning step of an ASIC.
4. Apply constructive partitioning algorithm to partition the given network to meet the following objectives.
 - Use no more than three ASICs
 - Each ASIC is to contain no more than three logic cells.
 - Use minimum number of external connections for each ASIC

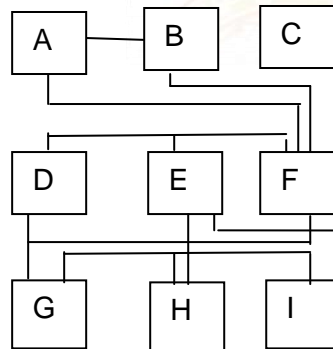

5. Apply K-L algorithm to partition the network represented by the given connectivity matrix consists of total of 6 cells in partition A (1-3 cells) and partition B (4-6 cells), to obtain the local optimum minimum.

$$c = \begin{bmatrix} 0 & 0 & 1 & 0 & 0 & 1 \\ 0 & 0 & 0 & 1 & 1 & 0 \\ 1 & 0 & 0 & 0 & 0 & 0 \\ 0 & 1 & 0 & 0 & 1 & 0 \\ 0 & 1 & 0 & 1 & 0 & 1 \\ 1 & 0 & 0 & 0 & 1 & 0 \end{bmatrix}$$

Course Outcome 3 (CO3)

1. Define goals and objectives of floorplanning.
2. Know wireload table
3. Explain the delay measurement in floorplanning step of an ASIC
4. Describe Mincut placement algorithm.
5. Apply eigen value placement algorithm to find the place of logic cells in an ASIC by finding eigen values and eigen vectors for the given network.

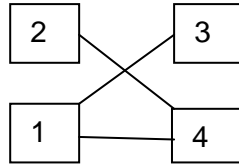

Course Outcome 4 (CO4)

1. Define Dogleg router
2. Discuss the problems in Layout Vs Schematic
3. Illustrate left edge algorithm with example.
4. Compare the various formats used for circuit extraction process
5. Differentiate the global routing done for CBIC and GA

Course Outcome 5 (CO5)

1. Design and simulate an 8 to 1 multiplexer using EDA tool.
2. Show the RTL schematic and compare the area report for direct implementation of full adder using basic gates with full adder using two half adders using EDA tool and Infer the result.
3. Show the Floorplanning of a 3 bit counter with D flipflops on an ASIC having the core to die aspect ratio of 0.7:0.3 using EDA tool.
4. Show the placement of serial adder circuit constructed using half adder on an ASIC using EDA tool.
5. Generate GDSII file for a 2-4 encounter circuit using EDA tool.
6. Optimize the netlist of a full subtractor circuit and analyze the reports with non-optimized reports.

Concept Map

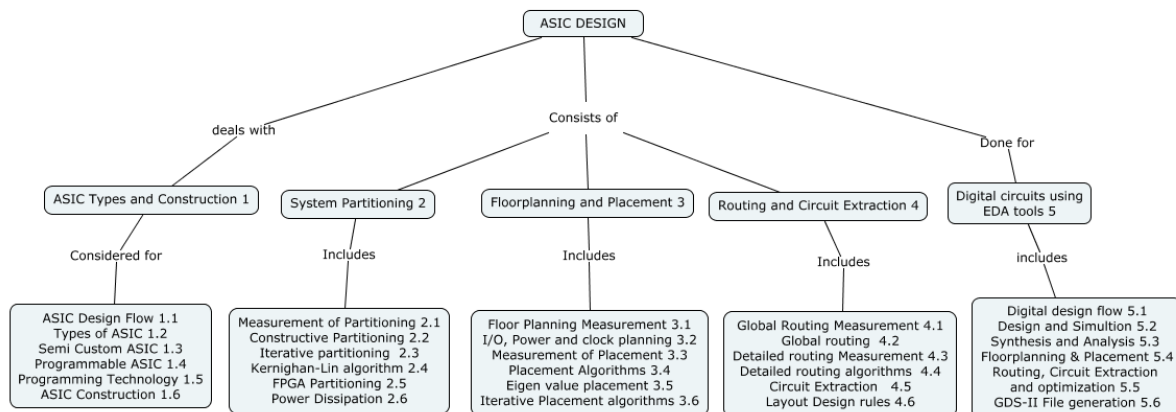

Syllabus

Theory:

ASIC Types and Construction: ASIC Design Flow, Types of ASIC - Full Custom, Semi Custom – Standard Cell Based ASIC and Gate Array ASIC, Programmable ASIC – PROM, PLA, PAL, CPLD, FPGA, Programming Technology – Antifuse, SRAM, EPROM, EEPROM, ASIC construction.

System Partitioning: Measurement of Partitioning, Partitioning Algorithms - Constructive Partitioning, Iterative Partitioning Improvement Algorithms - K-L Algorithm, FM algorithm, Ratio-Cut Algorithm, Look-Ahead Algorithm, Simulated Annealing, FPGA Partitioning, Power Dissipation.

Floorplanning and Placement: Floor Planning Measurement and tools, I/O, Power and clock planning, Measurement of Placement, Placement Algorithms – Min-cut Placement, Eigen value Placement, Iterative Placement Improvement and Timing driven Placement algorithms.

Routing and Circuit Extraction: Global Routing Measurement – Measurement of Interconnect Delay using Elmore's constant, Global routing for CBIC and GA, Detailed Routing Measurement - Measurement of Channel Density, Detailed routing Algorithms – LEA, Lee Maze and High tower Algorithms, Circuit extraction process, Layout Design Rules and Technology related issues.

Practical:

Experiments using EDA tools.

1. Digital ASIC design flow using EDA tool.
2. Design and Simulation using EDA simulation tool.
3. Synthesis and Analysis using EDA compiler tool.
4. Floorplanning and Placement using EDA backend design tool.
5. Routing, circuit extraction and optimization using EDA backend design tool.
6. Generate GDSII file in Digital ASIC design flow using EDA tools.

[For the Digital circuits - Multiplexer, Encoder, Decoder, Full adder/Subtractor, serial adder, 3 bit counter]

Text Book

1. Michael John Sebastian Smith, "Applications Specific Integrated Circuits", Pearson Education, Ninth Indian reprint, 13th edition, 2004.

Reference Books

1. Neil H.E.Weste, Eshraghian, "Principles of CMOS VLSI Design": Addison Wesley, 1999.
2. Wayne Wolf, "Modern VLSI design" - Addison Wesley, 1998.
3. Neil H.E.Weste, Eshraghian, "Principles of CMOS VLSI Design", Addison Wesley, 1999.
4. Cadence Digital Labs, Revision 2.0, University support team, Cadence, Bangalore.

Course Contents and Lecture Schedule

Module No.	Topic	No. of Lectures
1.	ASIC Types and Construction	
1.1	ASIC Design Flow	1
1.2	Types of ASIC – Full custom ASIC	1
1.3	Semi Custom ASIC – CBIC, GA	1
1.4	Programmable ASIC	1
1.5	Programming Technology – Antifuse, SRAM, EPROM, EEPROM	1
1.6	ASIC Construction	1
2.	System Partitioning	
2.1	Measurement of partitioning	1
2.2	Partitioning Methods-constructive partitioning	1
2.3	Iterative partitioning improvement algorithms	1
2.4	Kernighan Lin algorithm	1
2.5	FPGA Partitioning	1

Module No.	Topic	No. of Lectures
2.6	Power Dissipation	1
3	Floorplanning and Placement	
3.1	Floor Planning Measurement and tools	1
3.2	I/O, Power and clock planning	1
3.3	Measurement of Placement	1
3.4	Placement Algorithms – Min-cut placement	1
3.5	Eigen value placement	1
3.6	Iterative Placement improvement algorithms	1
4	Routing and Circuit Extraction	
4.1	Global Routing Measurement – Elmore's constant	1
4.2	Global routing – CBIC and GA	1
4.3	Detailed routing Measurement	1
4.4	Detailed routing algorithms – LEA, LeeMaze, Hightower	1
4.5	Circuit Extraction	1
4.6	Layout Design rules	1
5.	ASIC Design Flow using EDA tools.	24
	Total	48

Course Designers:

1. Dr.S.Rajaram rajaram_siva@tce.edu
2. Dr. K.Kalyani k_kalyani@tce.edu

14EC780	ELECTIVE LAB	Category	L	T	P	Credit
		PC	0	0	1	1

Each student will pursue any one lab from below:

EMBEDDED SYSTEM AND IOT LAB:

Preamble

The goals of this course are to supplement the theory course on embedded system and IOT. This is to assist the students in obtaining a better understanding of the concepts and technique of embedded system and IOT by giving hands on programming and hardware activities to the students in practicing the IOT concepts and protocols.

Prerequisite

Nil

Course Outcomes

On the successful completion of the course, students will be able to

CO1	Use the Intel Galileo board for accessing input and output ports through bare metal board programming	Apply
CO2	Use the Intel Galileo board for accessing input and output ports through OS level python coding	Apply
CO3	Use the intel Galileo board for connecting to the internet as a web server by arduino and java coding	Apply
CO4	Use the intel Galileo board for connecting to the internet as a web server by python and java coding	Apply
CO5	Analyze the throughput performance of data converters in the embedded board	Analyze
CO6	Analyze the IOT performance through LAN	Analyze

Mapping with Programme Outcomes

COs	PO 1	PO 2	PO 3	PO 4	PO 5	PO 6	PO 7	PO 8	PO 9	PO 10	PO 11	PO 12	PSO 1	PSO 2	PSO 3
CO1	S	M	L	-	S	-	-	L	M	L	-	-	M	-	-
CO2	S	M	L	-	S	-	-	L	M	L	-	-	M	-	-
CO3	S	M	L	-	S	-	-	L	M	L	-	L	M	-	L
CO4	S	M	L	-	S	-	-	L	M	L	-	L	M	-	L
CO5	M	L	-	-	S	-	-	M	L	L	-	L	L	-	L
CO6	M	L	-	-	S	-	-	L	M	L	-	L	L	-	L

S- Strong; M-Medium; L-Low

Syllabus

1. Understanding the Open source hardware and Tool chains
 - a. Study of Block diagram and schematics of OSHW plot form
2. Experimenting the arduino coding in Intel Galileo
 - a. Blinking LEDs
 - b. Hardware and software delay
3. Basic programs using GCC/ Python
 - a. Scanning keys
 - b. Blinking LEDs
4. Analog sensor interfacing with Intel Galileo

- a. Temp sensor
- b. Light sensor.
- c. Linear POT sensor
5. Digital sensor and actuator interfacing with Intel Galileo
 - a. Humidity/ Temperature sensor
 - b. Ultrasonic range sensor
 - c. DC and Servo motor interfacing
6. Actuator interfacing.
 - a. Interfacing DC motor
 - b. Interfacing servomotor
7. Developing a web server model with Intel Galileo
 - a. Implementing Time/ECHO Server
 - b. Implementing Chat Server
8. Implementing Data communication with Blue tooth Module-BLE
 - a. Analog sensor monitoring
 - b. Digital input monitoring
9. Implementing Data communication with WIFI module
 - a. Analog sensor monitoring
 - b. Digital input monitoring
10. Implementing IOT with sensors monitoring
 - a. Analog sensor monitoring
 - b. Digital input monitoring
11. Implementing IOT with actuator control
 - a. ON-OFF control
 - b. Analog control
12. Implementing the ideation by Do it Yourself
 Choose suitable sensors of your idea and show the block diagram and schematic
 Develop the pseudo code for the experiments for client side and serve side
 Develop the GCC /Python/Java code for your block diagram
 Demonstrate your setup with confident need of the application

Course Designers:

- | | |
|------------------------|-----------------|
| 1. Dr.K.Hariharan | khh@tce.edu |
| 2. Dr.M.S.K.Manikandan | manimsk@tce.edu |

BASEBAND WIRELESS COMMUNICATION LAB:**Preamble**

The purpose of this course is to give hands on training to the students in understanding the theory of baseband wireless communication systems. This will improve the understanding and simulation capability in wireless communications systems.

Prerequisite

Nil

Course Outcomes

On the successful completion of the course, students will be able to

CO1	Simulate BER performance of digital modulation schemes in Rayleigh flat channels in SISO, SIMO, MISO and MIMO wireless communication systems	Apply
CO2	Simulate BER performance of OFDM system	Apply
CO3	Simulate of MSE performance of LS and MMSE channel estimation techniques in OFDM systems.	Apply
CO4	Estimate Carrier frequency offset and timing offset in OFDM systems	Apply
CO5	Analyze outage capacity of Rayleigh flat fading channel without and with diversity.	Analyze

Mapping with Programme Outcomes

COs	PO 1	PO 2	PO 3	PO 4	PO 5	PO 6	PO 7	PO 8	PO 9	PO 10	PO 11	PO 12	PSO 1	PSO 2	PSO 3
CO1	S	S	M	L	S	-	-	L	M	L	-	L	S	L	L
CO2	S	S	M	L	S	-	-	L	M	L	-	L	S	L	L
CO3	S	M	L	-	S	-	-	L	M	L	-	L	S	L	L
CO4	S	M	L	-	S	-	-	L	M	L	-	L	S	L	L
CO5	S	S	M	L	S	-	-	L	M	L	-	L	S	L	L

S- Strong; M-Medium; L-Low

Syllabus

1. Simulation of BER performance of PSK and FSK schemes in Rayleigh frequency flat, slow fading channels
2. Simulation of BER performance of PSK scheme in Rayleigh frequency flat, slow fading channels with L^{th} order receive diversity.
3. Simulation of BER performance of PSK scheme in Rayleigh frequency flat, slow fading channels with Transmit diversity
4. Simulation of BER performance of PSK scheme in 2x2 spatial multiplexing system in Rayleigh frequency flat, slow fading channels.
5. Simulation of BER performance of OFDM system in Rayleigh frequency selective fading channels
6. LS and MMSE channel estimation in OFDM system
7. Carrier frequency offset estimation in OFDM system
8. Timing offset estimation in OFDM system
9. Outage capacity analysis of Rayleigh flat fading channel
10. Outage capacity analysis of Rayleigh flat fading channel with L^{th} order diversity

Course Designers:

1	Dr.S.J.Thiruvengadam	sjtece@tce.edu
2	Dr.M.N.Suresh	mnsece@tce.edu
3	Dr.K.Rajeswari	rajeswari@tce.edu

IMAGE AND VIDEO PROCESSING LABORATORY:**Preamble**

The course "Image and Video Processing Laboratory" is offered in the seventh semester and it is supplement to "Image Processing Theory Cum Practical".

The purpose of this course is to give hands on training to the students in understanding the theory of image and video processing. This will improve the capability of applying the image and video processing algorithms for real world problems.

Prerequisite

Nil

Course Outcomes

On the successful completion of the course, students will be able to

CO1	Explore and perform color image processing as well as improving the visual quality of the images with performance measure.	Analyse
CO2	Explore and perform medical image processing for abnormality analysis and achieve lossless compression.	Apply
CO3	Explore and perform feature extraction from Satellite images and further process it for change detection and land cover analysis,	Apply
CO4	Explore and perform content based image retrieval and apply it for	Apply

	real world applications.	
CO5	Explore and perform video processing algorithms for traffic surveillance applications as well as motion estimation for a given video sequence.	Apply

Mapping with Programme Outcomes

COs	PO 1	PO 2	PO 3	PO 4	PO 5	PO 6	PO 7	PO 8	PO 9	PO 10	PO 11	PO 12	PSO 1	PSO 2	PSO 3
CO1	S	S	M	L	M	L	-	L	M	M	-	L	S	M	L
CO2	S	S	M	L	M	M	-	M	M	M	-	L	S	M	L
CO3	S	S	M	L	M	M	L	M	M	M	-	-	S	M	L
CO4	S	S	M	L	M	M	-	M	M	M	-	L	S	M	L
CO5	S	S	M	L	M	M	-	M	M	M	-	L	S	M	L

S- Strong; M-Medium; L-Low

Syllabus

1. Measurement and Improvement of quality of images
2. Color model and color image processing
3. Lung Nodule detection for abnormality analysis
4. Medical Image compression: Lossless Approach
5. Texture feature extraction from satellite images
6. Change detection in satellite images
7. Classification of Land cover analysis
8. Content based image retrieval
9. Automated vehicle counting system based on blob analysis.
10. Perform motion estimation algorithm for a given video sequence.

Course Designers:

- | | |
|--------------------------|--|
| 1. Dr.S.Md.Mansoor Roomi | smmroomi@tce.edu |
| 2. Dr.R.A.Alaguraja | alaguraja@tce.edu |
| 3. Dr.A.Banumathi | au_banu@tce.edu |
| 4. Dr. B.Yogameena | ymece@tce.edu |
| 5. Dr.B.Sathyabama | sbece@tce.edu |

NETWORKING LAB:

Preamble

The goals of this course are to assist the students in obtaining a better understanding of the characteristics of communication networks by giving hands on programming and lab activities to the students in practicing the networking concepts and protocols.

Prerequisite

Nil

Course Outcomes

On the successful completion of the course, students will be able to

CO1	Design different types of Local Area Networks to understand its behaviour	Apply
CO2	Analyze the performance of reliable data transfer protocols	Analyze
CO3	Apply routing algorithms for wired and wireless networks	Apply
CO4	Apply data security algorithms in networks	Apply
CO5	Design and setup WSN/VANET/IoT using simulators	Apply

Mapping with Programme Outcomes

COs	PO 1	PO 2	PO 3	PO 4	PO 5	PO 6	PO 7	PO 8	PO 9	PO 10	PO 11	PO 12	PSO 1	PSO 2	PSO 3
CO1	S	M	L	-	S	-	-	S	S	M	M	M	M	L	M
CO2	S	S	M	-	S	-	-	S	S	M	M	M	S	L	M
CO3	S	M	L	-	S	-	-	S	S	M	M	M	M	L	M
CO4	S	M	L	-	S	-	-	S	S	M	M	M	M	L	M
CO5	S	M	L	-	S	-	-	S	S	M	M	M	M	L	M

S- Strong; M-Medium; L-Low

Syllabus

1. Comparing the throughput analysis using LAN and WLAN trainer kit
 - a. Simulate an Ethernet LAN using N-nodes (6-10) and compare the throughput performance
 - b. Configure WLAN and Compare its throughput when clients are increased
2. Constructing the point-to-point networks using network simulator packages – NS2 / NS3 and analyzing the network parameters
 - a. Packet Delivery Ratio
 - b. Throughput.
 - c. Packet Drops.
3. Implementing Flow control protocols using NS2
 - a. Stop-and-wait protocol
 - b. Sliding window protocol
4. Implementing wired and wireless routing protocols
 - a. Routing Information Protocol
 - b. AODV
 - c. DSR
5. Implementing Security Algorithms
 - a. AES
 - b. MD5/SHA
 - c. Key Exchange Algorithms
6. Constructing Application specific networks
 - a. WSN using NS2
 - b. VANET using CARSIM
7. Case Study PAN and WAN
 - a. Setting up Bluetooth
 - b. Setting up WiMAX

Course Designers:

Dr. T. Aruna

tace@tce.edu

Mrs. E. Murugavalli

murugavalli@tce.edu**VLSI LAB:****Preamble**

The course “14EC590: VLSI Systems Laboratory” is offered in the seventh semester which provide an experimental setup for all the subjects related to VLSI. The purpose of this course is to give hands on training to the students in understanding the theory of both analog and digital VLSI subjects and practicing sessions used in design of analog circuits and digital

systems. This will improve the capability of the design of analog circuit and digital system design using various simulation as well as implementation tools.

Prerequisite

NII

Course Outcomes

On the successful completion of the course, students will be able to

CO1	Design and simulation of digital circuits and systems using Modelsim.	Apply
CO2	FPGA implementation of digital circuits and systems using Quartus II	Apply
CO3	Design of Analog and digital circuit design using EDA tool.	Analyze
CO4	Analysis and simulation of characteristics of MOSFET using TCAD	Analyze

Mapping with Programme Outcomes

COs	PO	PO	PO	PO	PO	PO	PO	PO	PO	PO	PO	PO	PSO	PSO	PSO
	1	2	3	4	5	6	7	8	9	10	11	12	1	2	3
CO1	S	-	S	-	S	-	-	L	S	L	-	M	M	L	M
CO2	S	-	S	-	S	-	-	L	S	L	-	M	M	L	M
CO3	S	S	S	-	S	-	-	L	S	L	-	M	S	L	M
CO4	S	S	S	-	S	-	-	L	S	L	-	M	S	L	M
CO5	S	S	-	-	S	-	-	L	S	L	-	M	M	L	M

S- Strong; M-Medium; L-Low

Syllabus

1. Design and simulation of Binary Multiplier using Modesim.
2. Synthesis and analysis of Synchronous counter.
3. FPGA implementation of serial adder using Quartus II.
4. FPGA implementation of FSM of parity generator using Quartus II
5. Design and Implementation of Inverter from schematic to layout using EDA Tool.
6. Design and Implementation of NAND gate from schematic to layout using EDA Tool.
7. Design, simulation synthesis and analysis of Multiplexer using EDA tools.
8. Generation of GDS-II file for 3-bit counter using EDA tools.
9. Design and simulation of Potential Distribution/Field of the MOSFET using finite difference method.
10. Design and simulation of P-Channel and N-Channel MOSFET using TCAD.

Course Designers:

- | | |
|-----------------------------|--|
| 1. Dr.S.Rajaram | rajaram_siva@tce.edu |
| 2. Dr.N.B.Balamurugan | nbbalamruga@tce.edu |
| 3. Dr.V.Vinoth Thyagarajan | vvkece@tce.edu |
| 4. Dr.D.Gracia Nirmala Rani | gracia@tce.edu |
| 5. Dr.V.R.Venkatasubramani | venthiru@tce.edu |
| 6. Dr.K.Kalyani | k_kalyani@tce.edu |

RF LAB:

Preamble

The purpose of this course is to coach the students in the area of design, simulation and testing of RF components.

Prerequisite

NII

Course Outcomes

On the successful completion of the course, students will be able to

CO1	Design and simulation of RF amplifier	Apply
CO2	Measure the parameters for different RF modules	Evaluate
CO3	Design and simulate a RF Oscillator	Apply
CO4	Design a Low noise amplifier	Apply
CO5	Measure the harmonics and fundamental frequency of a mixer circuit	Analyse

Mapping with Programme Outcomes

COs	PO 1	PO 2	PO 3	PO 4	PO 5	PO 6	PO 7	PO 8	PO 9	PO 10	PO 11	PO 12	PSO 1	PSO 2	PSO 3
CO1	S	M	L	-	M	-	-	L	L	-	-	L	S	-	-
CO2	S	S	S	-	M	-	-	L	L	-	-	L	S	L	-
CO3	S	M	L	-	M	-	-	L	L	-	-	L	S	-	-
CO4	S	M	L	-	M	-	-	L	L	-	-	L	S	-	-
CO5	S	S	M	-	M	-	-	L	L	-	-	L	S	L	-

S- Strong; M-Medium; L-Low

Syllabus

Design, simulation and testing of

1. Amplifier
2. Oscillator
3. Low Noise Amplifier
4. Mixer
5. Antenna array

Course Designers:

1. Dr.B.Manimegalai naveenmegaa@tce.edu
2. Dr.A.Thenmozhi thenmozhi@tce.edu

14EC7C0	CAPSTONE II	Category	L	T	P	Credit
		PC	0	0	2	2

Preamble

The purpose of this course is to apply the concept of mathematics, science and engineering fundamentals and an engineering specialization to solve complex engineering problems.

Prerequisite

Nil

Course Outcomes

On the successful completion of the course, students will be able to

CO1	Explain the basic concepts of core engineering courses in the programme	Understand
CO2	Solve complex problems in core engineering courses of the programme	Apply
CO3	Identify and formulate a complex engineering problem	Analyze
CO4	Develop solution methodology for the chosen engineering problem	Analyze
CO5	Provide solution for the chosen engineering problem	Analyze
CO6	Analyze the performance of the proposed methodology and prepare a technical report	Analyze

Mapping with Programme Outcomes

COs	PO 1	PO 2	PO 3	PO 4	PO 5	PO 6	PO 7	PO 8	PO 9	PO 10	PO 11	PO 12	PSO 1	PSO 2	PSO 3
CO1	M	L	-	-	-	-	-	-	-	-	-	S	L	-	-
CO2	S	M	L	-	-	S	-	-	M	M	-	S	L	L	-
CO3	S	S	M	L	L	S	M	S	M	M	L	S	M	M	M
CO4	S	S	M	L	L	M	M	S	S	M	L	S	M	M	M
CO5	S	S	M	L	S	-	S	S	S	M	L	S	M	M	S
CO6	S	S	M	L	S	S	S	S	S	S	M	S	M	S	S

S- Strong; M-Medium; L-Low

Syllabus**ENGINEERING GROUP 1:**

Random processes: autocorrelation and power spectral density, properties of white noise, filtering of random signals through LTI systems; Analog communications: amplitude modulation and demodulation, angle modulation and demodulation, spectra of AM and FM, superheterodyne receivers, circuits for analog communications; Information theory: entropy, mutual information and channel capacity theorem; Digital communications: PCM, DPCM, digital modulation schemes, amplitude, phase and frequency shift keying (ASK, PSK, FSK), QAM, MAP and ML decoding, matched filter receiver, calculation of bandwidth, SNR and BER for digital modulation; Fundamentals of error correction, Hamming codes; Timing and frequency synchronization, inter-symbol interference and its mitigation; Basics of TDMA, FDMA and CDMA.

ENGINEERING GROUP 2:

Electrostatics; Maxwell's equations: differential and integral forms and their interpretation, boundary conditions, wave equation, Poynting vector; Plane waves and properties: reflection and refraction, polarization, phase and group velocity, propagation through various media, skin depth; Transmission lines: equations, characteristic impedance, impedance matching, impedance transformation, S-parameters, Smith chart; Waveguides: modes, boundary

conditions, cut-off frequencies, dispersion relations; Antennas: antenna types, radiation pattern, gain and directivity, return loss, antenna arrays; Basics of radar; Light propagation in optical fibers.

Assessment Pattern

(Common to B.E./B.Tech Programmes)

Comprehensive Test (30 Marks)

Test 1: Engineering Group 1 (60 Marks)

Duration: 90 Minutes

Objective Type Questions : 30

Fill up the blanks : 30

Test 2: Engineering Group 2 (60 Marks)

Duration: 90 Minutes

Objective Type Questions : 30

Fill up the blanks : 30

Test	Marks Obtained	Converted to
Test1	60 Marks (Max)	15 Marks (Max)
Test 2	60 Marks (Max)	15 Marks (Max)
		30 Marks (Max)

No re-test will be conducted at any circumstances

Complex Engineering Problem Solving (70 Marks):

- Selection of a complex engineering problem (Batch size: 2-4) : 5 Marks
- Literature Survey : 5 Marks
- Problem Formulation : 10 Marks
- Solution Methodology : 15 Marks
- Results and Discussion : 15 Marks
- Technical Report : 10 Marks
- Viva Voce : 10 Marks

Course Designers:

1. Dr.S.J. Thiruvengadam sjtece@tce.edu

**CURRICULUM AND DETAILED SYLLABI
OF
ELECTIVES COURSES
FOR**

B.E. DEGREE PROGRAMME

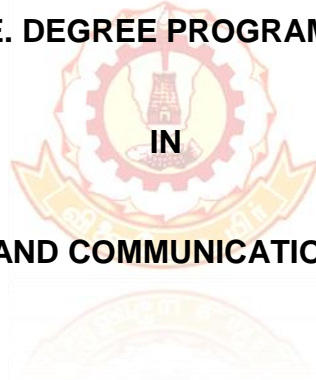

ELECTRONICS AND COMMUNICATION ENGINEERING

**FOR THE STUDENTS ADMITTED IN THE
ACADEMIC YEAR 2014-15 ONWARDS**

**DEPARTMENT OF ELECTRONICS AND COMMUNICATION
ENGINEERING
THIAGARAJAR COLLEGE OF ENGINEERING**

(A Government Aided ISO 9001:2008 certified Autonomous Institution affiliated to Anna University)

MADURAI – 625 015, TAMILNADU

Phone: 0452 – 2482240, 41

Fax: 0452 2483427

Web: www.tce.edu

Programme Electives:

Course Code	Course Name
14ECPA0	DSP Architecture and Programming
14ECPB0	Embedded System Design
14ECPC0	Digital System Design using FPGA
14ECPD0	Control Systems
14ECPE0	Data Structures and Algorithms
14ECPF0	Real Time System Design
14ECPG0	Statistical Signal Processing
14ECPH0	Radar Systems
14ECPJ0	Bio-Medical Instrumentation
14ECPK0	Network Security
14ECPL0	Software Defined and Cognitive Radio Networks
14ECPM0	Low Power VLSI Systems
14ECPN0	VLSI Device Modeling
14ECPPO	Digital Video Processing
14ECPQ0	Medical Imaging and Processing
14ECPR0	Satellite Remote Sensing
14ECPSS0	Internet of Things
14ECPST0	Radio Frequency Integrated Circuits
14ECPU0	RF System Design and Measurements
14ECPV0	Physical Layer LTE System
14ECPW0	Mixed Signal Integrated Circuits
14ECPY0	Electrical and Electronic Measurement
14ECPZ0	Speech Signal Processing
14ECRA0	Audio Signal Processing
14ECRB0	Computer Vision and Applications
14ECRC0	Satellite Image Analysis
14ECRD0	Data Compression
14ECRE0	Electromagnetic Interference and Compatibility
14ECRF0	RF MEMS
14ECRG0	Planar Antennas for Wireless Applications
14ECRH0	Wireless Technologies with Mobile Internet
14ECRJ0	Adhoc and Sensor Networks
14ECRK0	Cooperative Communication Networks
14ECRL0	CAD for VLSI
14ECRM0	Image Analysis and Visualization

Industry Supported Courses:

Course Code	Course Name
14EC2A0	Device Characterization
14EC2B0	Semiconductor Modeling
14EC2C0	RF Design and Measurement Tools

14ECPA0	DSP ARCHITECTURE AND PROGRAMMING	Category	L	T	P	Credit
		PC	2	0	2	3

Preamble

The course “DSP Architecture and Programming” is offered as an elective subject in continuation with core subject 14EC340 Signals and Systems and 14EC440 Signal processing. This course describes the architecture and instruction set of Blackfin processor to design and implement digital filters for real world applications.

Prerequisite

14EC340: Signals and Systems

14EC440: Signal Processing.

Course Outcomes

On the successful completion of the course, students will be able to

CO1. Explain architecture of Blackfin processor	Remember
CO2. Explain instruction set of Blackfin processor	Understand
CO3. Write and simulate basic programs in BF533 assembly language.	Apply
CO4. Represent signal samples in fixed point format and perform arithmetic operations based on this format.	Apply
CO5. Develop ALP and C coding to implement FIR filter, IIR filter and their frequency domain analysis	Apply
CO6. Develop ALP and C code for audio signal processing applications	Apply

Mapping with Programme Outcomes

COs	PO 1	PO 2	PO 3	PO 4	PO 5	PO 6	PO 7	PO 8	PO 9	PO 10	PO 11	PO 12	PSO 1	PSO 2	PSO 3
CO1	M	L	-	-	-	-	-	-	L	L	-	-	S	L	L
CO2	M	L	-	-	S	-	-	-	L	L	-	-	S	L	L
CO3	M	L	-	-	S	-	-	-	M	M	-	L	S	L	L
CO4	M	L	-	-	S	-	-	-	M	M	-	L	S	M	L
CO5	S	S	M	L	S	-	-	-	M	M	-	L	S	M	L
CO6	S	S	M	L	S	-	-	-	M	M	-	L	S	M	L

S- Strong; M-Medium; L-Low

Assessment Pattern

Bloom's Category	Continuous Assessment Tests			Terminal Examination
	1	2	3	
Remember	20	10	Practical	10
Understand	20	30		30
Apply	60	60		60
Analyse	0	0		0
Evaluate	0	0		0
Create	0	0		0

Course Level Assessment Questions

Course Outcome 1(CO1):

1. Identify the inbuilt peripherals in Blackfin processor.
2. Mention the computational units available in Blackfin processor.
3. Lists the flags and their positions in ASTAT register.
4. What are the different mapping schemes of cache and describe them.

Course Outcome 2 (CO2):

1. How is Blackfin processor able to support multi-issue capability?
2. In what way, instruction alignment unit supports program sequencer?
3. Write the content of R0 after executing the instructions given below.

R0 contains 0000 B6A3;

R0 >> =0X04;

Course Outcome 3 (CO3)

1. Write a program to split each element of an array (containing five 32-bit numbers) in to 16-bit LSBs with sign extension and zero extension store them in an output array (containing ten 32-bit numbers)
2. Write an Assembly language program in BF533 to arrange the number in descending order for the given array.

$Input = \{0x2828, 0xC444, 0x1234, 0x2F02, 0x7777, 0xEFFE\}$

3. Write an Assembly language program in BF533 to split each element of an array (containing five 32 bit numbers) in to 16 bit LSB and 16 bit MSB and store them in two different arrays (each containing five 16 bit numbers), then perform addition for positive number in output array1 and take absolute value for negative number in output array2.

$Input = \{0xAB022828, 0x0ABCC444, 0x1DB14567, 0xD1019244\}$

Course Outcome 4 (CO4):

1. Represent -0.01171875 in 1.15 format.
2. Find the largest positive value represented by 4.12 format.
3. Write the difference between truncation and rounding. What are the types of rounding? Give examples for types of rounding.

Course Outcome 5 (CO5):

1. Write a program for convolution using sample processing algorithm.
2. Consider a signal $x(n)$ consists of sine wave corrupted by random noise. Design and simulate a digital low pass filter to reduce noise.
3. Write a program in embedded C to compute magnitude spectrum of the input sinusoidal signal.

Course Outcome 6 (CO6):

1. Design a set of HRIR (Head Related Impulse Response) at an azimuth of 30° and elevation of 0° . Write an ALP to convolve mono sound source with designed HRIR filter.
2. Write an ALP to introduce audio effects such as flanging and chorusing.
3. Write an ALP to control volume of an audio input signals.

Concept Map

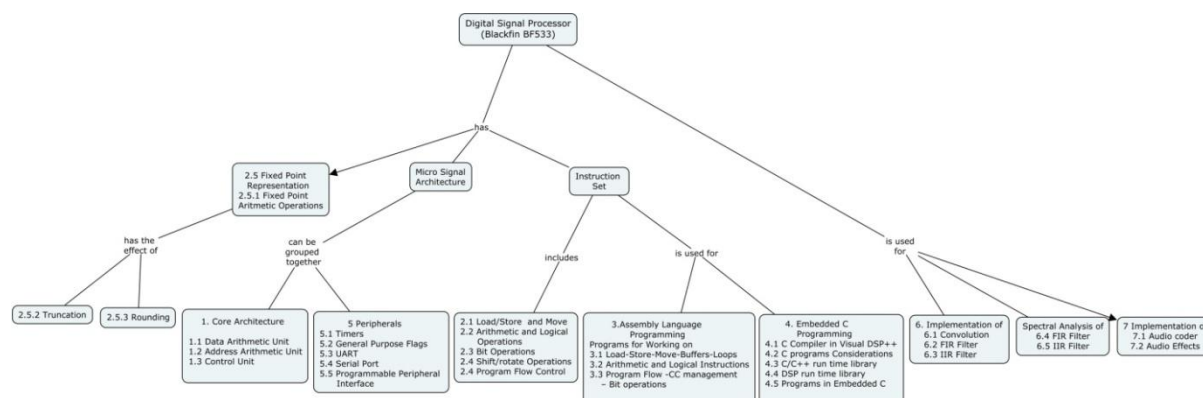

Syllabus

Core Architecture: Micro signal architecture Blackfin processor, Data Arithmetic Unit, Address Arithmetic Unit, Control Unit

Instruction Set: Load/Store, move, Arithmetic and Logical operations, Bit operations, Shift/Rotate operations, Program flow control, Fixed point representation- Truncation and Rounding

Assembly Language Programming: Programs for working on Load-Store – Move – Buffers - Loops, Programs for working on Arithmetic and Logical instructions, Programs for working on Program flow – CC management – Bit operations

Embedded C programming: C compilers in Visual DSP++, C programs considerations, C/C++ run time Library, DSP run time library, programs in embedded C.

Peripherals: Timers, General purpose flags, UART, serial port, programmable peripheral interface.

Implementation: Convolution, FIR filter, IIR filter, Spectral analysis of FIR and IIR filter.

Applications: Audio coder, Audio effects.

List of Laboratory Experiments

1. Basic Programs
 - a) Programs for Working on Load-Store-Move-Buffers-Loops
 - b) Programs for Working on Arithmetic and Logical Instructions
 - c) Programs for Working on Program Flow - CC management – Bit operations
2. Implement FIR filter using sample processing algorithm
3. Implement FIR filter using input and output side based convolution
4. Implement IIR filter using sample processing algorithm
5. Implement 5 point moving average filter in BF533 EZ-KIT to extract sinusoidal signal that is corrupted by random noise
6. Implement three way cross over filter that splits audio input signal in to its low, mid and high frequency components.
7. Implement volume control of an audio input signals using BF-533 EZ-KIT.

Text Books

1. ADSP-BF533 Blackfin Processor Hardware Reference 2005.
2. Blackfin Processor Instruction Set Reference 2004.
3. Woon-Seng Gan, Sen.M.Kuo, Embedded Signal Processing with Micro-Signal Architecture, John Wiley Sons, 2007

Reference Books:

1. Udo Zolzer "Digital Audio Signal Processing", Wiley, Second Edition, 2008.

Course Contents and Lecture Schedule

Module No.	Topic	No. of Lectures
1	Core Architecture	
1.1	Micro signal architecture Blackfin processor	1
1.2	Data Arithmetic Unit	1
1.3	Address Arithmetic Unit	1
1.4	Control Unit	1
2	Instruction Set	
2.1	Arithmetic and Logical operations	1
2.2	Bit operations	1
2.3	Shift/Rotate operations, Program flow control	1
2.4	Fixed point representation- Truncation and Rounding	1
	Tutorial	1
3	Assembly Language Programming	
3.1	Programs for working on Load-Store – Move – Buffers - Loops	1
3.2	Programs for working on Arithmetic and Logical instructions	1
3.3	Programs for working on Program flow – CC management – Bit operations	1
4	Embedded C programming	
4.1	C compilers in Visual DSP++, C programs considerations	1
4.2	C/C++ run time Library, DSP run time library, programs in embedded C	1
5	Peripherals	
5.1	Timers, General purpose flags	1
5.2	UART	1
5.3	Serial port	1
5.4	Programmable peripheral interface	1
6	Implementation	
6.1	Convolution	1
6.2	FIR filter, IIR filter	1
6.3	Spectral analysis of FIR and IIR filter.	1
7	Applications	
7.1	Audio coder	2
7.2	Audio effects	1
	Total	24

Course Designers:

1	Dr.S.J.Thiruvengadam	sjtece@tce.edu
2	Dr.K.Rajeswari	rajeswari@tce.edu
3	Dr.P.G.S.Velmurugan	pgsvels@tce.edu

14ECPB0	EMBEDDED SYSTEM DESIGN	Category	L	T	P	Credit
		PE	3	0	0	3

Preamble

This course attempts to make the students familiar with modern embedded system involved in understanding CISC and RISC architecture, operating system and designing real-time based embedded systems. Unlike general purpose computing platforms, embedded systems must perform their tasks while minimizing tight resource constraints. CISC and RISC processors are embedded in products ranging from cell/mobile phones to automotive braking systems. The course begins by briefly noting the ARM7 and Cortex M processor, design philosophy and discussing how and why it differs from the traditional philosophy and also introduces embedded system based ARM7 and Cortex processor and also discusses the memory protection unit, and memory management unit.

Prerequisite

14EC420 Microcontroller

Course Outcomes

On the successful completion of the course, students will be able to

CO1. List and describe the RISC and CISC architecture	Remember
CO2: Distinguish between feature of ARM7 and cortex microcontroller	Understand
CO3: Illustrate the effectiveness of programming model in cortex M	Apply
CO4: Develop efficient coding for multiple interrupt handling	Apply
CO5: Design a control electronic system for industrial automation	Create
CO6: Develop an embedded system for data acquisition and monitoring	Create

Mapping with Programme Outcomes

COs	PO 1	PO 2	PO 3	PO 4	PO 5	PO 6	PO 7	PO 8	PO 9	PO 10	PO 11	PO 12	PSO 1	PSO 2	PSO 3
CO1	M	L	-	-	-	-	-	L	M	L	-	-	L	-	-
CO2	M	L	-	-	-	-	-	L	M	L	-	-	L	-	-
CO3	S	M	L	-	-	-	-	L	M	L	-	L	M	-	L
CO4	S	M	L	-	-	-	-	L	M	L	-	L	M	-	L
CO5	S	M	L	-	-	-	-	M	L	L	-	L	M	-	L
CO6	S	M	L	-	-			L	M	L		L	M		L

S- Strong; M-Medium; L-Low

Assessment Pattern

Bloom's Category	Continuous Assessment Tests			Terminal Examination
	1	2	3	
Remember	20	20	10	10
Understand	40	40	20	20
Apply	40	40	30	30
Analyse	0	0	0	0
Evaluate	0	0	0	0
Create	0	0	40	40

Course Level Assessment Questions

Course Outcome 1 (CO1):

1. Distinguish between RISC and CISC microcontroller
2. List the ARM microcontrollers
3. Define the functionality of CPU in microprocessor and microcontroller
4. Distinguish between 16 bit and 32 bit microcontroller

Course Outcome 2 (CO2)

1. Define the interrupts structure in ARM
2. List the describe registers present in ARM
3. Define the functionality of a serial peripheral in Cortex
4. Show that how do you access the peripherals in ARM

Course Outcome 3(CO3):

1. Demonstrate the timer peripheral in mode 1 operation
2. Give an example for accessing serial peripheral in polling driven
3. Describe the use of serial peripheral in asm programming
4. Develop a C program for a described value of time delay

Course Outcome 4 (CO4):

1. Demonstrate the timer peripherals with various modes
2. Give an example for accessing timer in asm and C program
3. Describe the functionality of the GPIO hardware for accessing IO device
4. Distinguish between timer and counter in its modes of operation

Course Outcome 5 (CO5):

1. Illustrate the serials peripherals for transmitting the data in defined baud rate
2. Show the program for accessing an ADC and show it in LED display
3. Demonstrate the operation of keyboard interfacing with Cortex board
4. Construct the program for interfacing LCD module with Cortx board

Course Outcome 6 (CO6):

1. Illustrate the ARM c program that how to handle interrupts for cortex board
2. Show the c program for accessing a analog sensor and send the data to serial port
3. Demonstrate the operation of c program for interfacing analog sensor with WIFI shield and make the system to IOT
4. Construct the c program for accessing blue tooth for IOT application

Concept Map

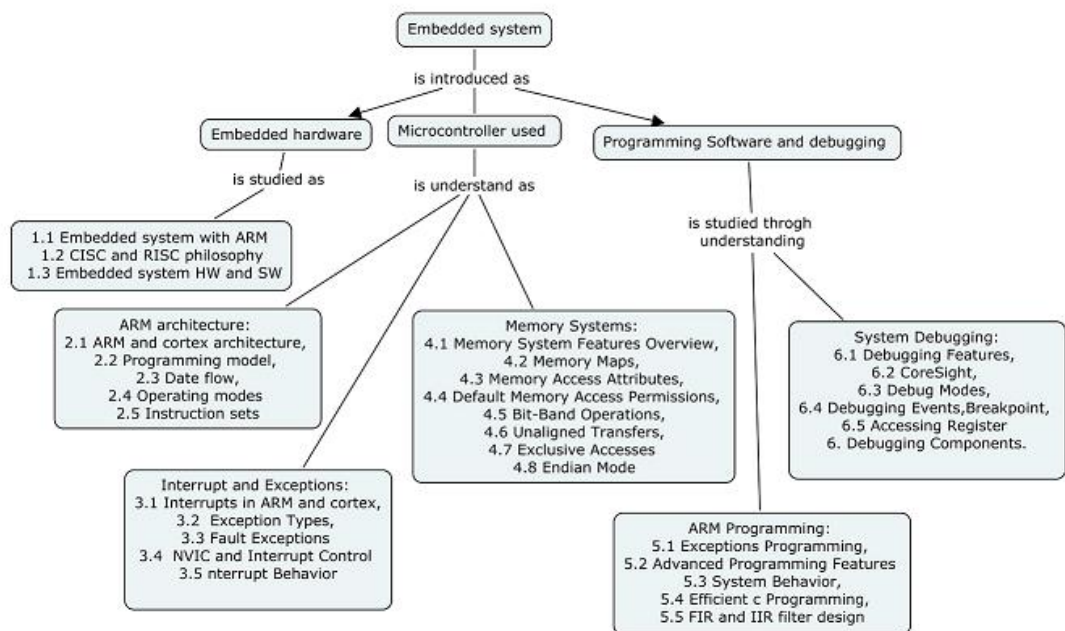

Syllabus

Embedded hardware: ARM Embedded system, CISC and RISC philosophy, Embedded system Hardware

ARM and Cortex architecture: ARM and Cortex architecture, Programming model, Data flow, Operating modes and Instruction sets

Interrupt and Exceptions: Interrupts in ARM and cortex, Exception Types, Fault Exceptions The NVIC and Interrupt Control and Interrupt Behavior

Memory Systems: Memory System Features Overview, Memory Maps, Memory Access Attributes, Default Memory Access Permissions, Bit-Band Operations, Unaligned Transfers, Exclusive Accesses and Endian Mode

Programming: Exceptions Programming, Advanced Programming Features and System Behavior, Efficient C Programming, FIR and IIR filter implementation. Introduction to RTOS

System Debugging: Debugging Features, CoreSight, Debug Modes, Debugging Events, Breakpoint, Accessing Register and Debugging Components.

Case study: Embedded system (using ARM/cortex) for monitoring, controlling and industrial automation

Text Books

1. Andrew N. Sloss Dominic Symes Chris Wright, "ARM System Developer's Guide Designing and Optimizing System Software", Elsevier Inc 2010.
2. "The Definitive Guide to the ARM Cortex-M" Joseph Yiu, Elsevier- Newness, 2014

Reference Books

1. Peter Barry Patrick Crowley "Modern Embedded Computing Designing Connected, Pervasive, Media- Rich Systems", Elsevier, 2012

Course Contents and Lecture Schedule

Module No.	Topic	No. of Lectures
1	Embedded system with ARM	
1.1	ARM Embedded system	1
1.2	CISC and RISC philosophy	1
1.3	Embedded system HW and SW	1
2	ARM architecture:	
2.1	ARM and cortex architecture	1
2.2	Programming model	1
2.3	Data flow	1
2.4	Operating modes	2
2.5	Instruction sets	1
3	Interrupt and Exceptions:	
3.1	Interrupts in ARM and cortex	1
3.2	Exception Types	2
3.3	Fault Exceptions	1
3.4	The NVIC and Interrupt Control	1
3.5	Interrupt Behavior	2
4	Memory Systems	
4.1	Memory System Features Overview	2
4.2	Memory Maps	2
4.3	Memory Access Attributes	1
4.4	Default Memory Access Permissions	1
4.5	Bit-Band Operations and Unaligned Transfers	1
4.6	Exclusive Accesses and Endian Mode	1
5	ARM Programming:	
5.1	Exceptions Programming	2

5.2	Advanced Programming Features and System Behavior	2
5.3	Efficient c Programming	2
5.4	Digital signal processing FIR and IIR filter design	2
5.5	RTOS concepts	1
6	System Debugging	
6.1	Debugging Features	1
6.2	CoreSight	1
6.3	Debug Modes	1
6.4	Debugging Events	1
6.5	Breakpoint	1
6.6	Accessing Register	1
6.7	Debugging Components	1
	Total	40

Course Designers:

1. Dr.K. Hariharan khh@tce.edu
2. Dr.L.R.Karl Marx lrkarlmarx@tce.edu



14ECPC0	DIGITAL SYSTEM DESIGN USING FPGA	Category	L	T	P	Credit
		PE	3	0	0	3

Preamble

Digital System Design using FPGA aims at analysis, design and optimization of sequential circuits, design of arithmetic circuits with control units, classification of various memory architecture, detailed description of FPGA architecture and implementation of these digital system building blocks on FPGA. It is also a study of characteristics and analysis of various digital IC logic families.

Prerequisite

14EC270 Digital Logic Circuit Design

Course Outcomes

On the successful completion of the course, students will be able to

CO1	Analysis, Design and Optimisation of the sequential digital systems.	Analyze
CO2	Design of arithmetic circuits with control unit	Apply
CO3	Understand and Classify the various memory architectures.	Analyze
CO4	Describe the FPGA architecture- logic cell, I/O cell and interconnects.	Analyze
CO5	Apply the given specifications to analyze the architecture of digital IC logic families.	Analyze

Mapping with Programme Outcomes

COs	PO 1	PO 2	PO 3	PO 4	PO 5	PO 6	PO 7	PO 8	PO 9	PO 10	PO 11	PO 12	PSO 1	PSO 2	PSO 3
CO1	S	S	M	L	S	-	-	L	M	-	M	M	S	L	M
CO2	S	M	L	-	S	-	-	L	M	-	L	M	S	-	M
CO3	S	S	M	L	-	-	-	L	M	M	-	M	M	L	L
CO4	S	S	M	L	M	-	-	L	M	M	-	S	M	L	S
CO5	S	S	M	L	M	-	-	L	M	-	-	M	M	L	M
CO6	S	S	M	L	M	-	-	L	M	L	L	M	M	L	M

S- Strong; M-Medium; L-Low

Assessment Pattern

Bloom's Category	Continuous Assessment Tests			Terminal Examination
	1	2	3	
Remember	0	0	0	0
Understand	20	20	20	20
Apply	60	60	60	60
Analyse	20	20	20	20
Evaluate	0	0	0	0
Create	0	0	0	0

Course Level Assessment Questions**Course Outcome 1 (CO1)**

- (a) For the following sequential circuit, determine the next-state equation or map for each flip-flop. Using these next-state equations or maps, construct a transition table and graph for the circuit.
- (b) Determine the output sequence when the input sequence is $X = 01100?$

(c) Draw a timing diagram for the input sequence in (b). Show the clock, X, A, B and Z. Assume that the input changes between falling and rising clock edges.

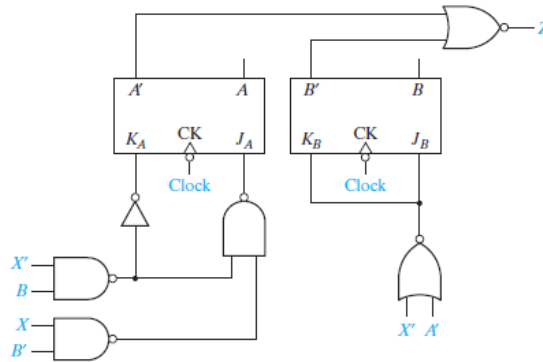

2. A sequential circuit has one input (X) and two outputs (Z_1 and Z_2). An output $Z_1 = 1$ occurs every time the input sequence 010 is completed, provided that the sequence 100 has never occurred. An output $Z_2 = 1$ occurs every time the input 100 is completed. Note that once a $Z_2 = 1$ output has occurred, $Z_1 = 1$ can never occur but *not vice versa*. Determine a Mealy state graph and state table (minimum number of states is eight).
3. A sequential circuit has two inputs (X_1 and X_2) and one output (Z). The output begins as 0 and remains a constant value unless one of the following input sequences occurs:
 - (a) The input sequence $X_1X_2 = 11, 10$ causes the output to become 0.
 - (b) The input sequence $X_1X_2 = 00, 10$ causes the output to become 1.
 - (c) The input sequence $X_1X_2 = 01, 10$ causes the output to toggle.
 Determine a Moore state table.
4. The following table is to be realized using D flip-flops.
 - (a) Determine a good state assignment using the three guidelines (do not reduce the table first.) Try to satisfy as many of the adjacency conditions as possible.
 - (b) Using this assignment, determine the D flip-flop input equations and the output equations.

	X		Z	
	0	1	0	1
A	F	D	0	0
B	D	B	0	0
C	A	C	0	1
D	F	D	0	0
E	A	C	0	1
F	F	B	0	0

5. Construct the circuit using D flip-flops and gates for the given state graph. Use a one-hot assignment and write down the logic equations by inspecting the state graph.

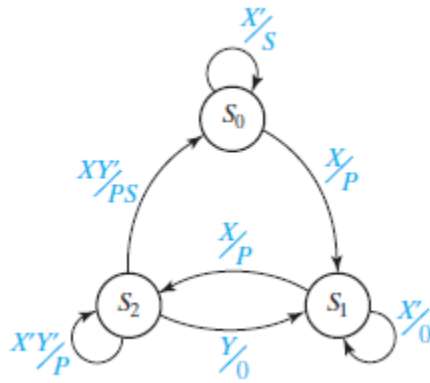

Course Outcome 2 (CO2)

1. Construct a serial subtractor with accumulator for 5-bit binary numbers. Assume that negative numbers are represented by 2's complement. Give the state graph for the control circuit. Assume that St will remain 1 until the subtraction is complete, and the circuit will not reset until St returns to 0.
2. Construct a binary multiplier which multiplies two 3-bit binary numbers to form a 6-bit product. This multiplier is to be a combinational circuit consisting of an array of full adders and AND gates (no flip-flops).
3. The binary multiplier has been modified so that whenever addition occurs the multiplier bit (M) will be set to 0. Specifically, the Ad signal is now connected to a synchronous clear input on only the rightmost flip-flop of the product register. Thus, if M is 1 at a given clock time and addition takes place, M will be 0 at the next clock time. Now, we can always add when $M = 1$ and always shift when $M = 0$. This means that the control circuit does not have to change state when $M = 1$, and the number of states can be reduced from ten to six. Draw the resulting state graph for the multiplier control with six states.
4. In order to allow for a larger number of bits, the control circuit of the binary divider is to be modified so that it uses a separate counter and a subtract shift control. Draw the state graph for the subtract-shift control.
5. A serial logic unit has two 8-bit shift registers, X and Y , shown as follows. Inputs K_1 and K_2 determine the operation to be performed on X and Y . When $St = 1$, X and Y are shifted into the logic circuit one bit at a time and replaced with new values. If $K_1K_2 = 00$, X is complemented and Y is unchanged. If $K_1K_2 = 01$, X and Y are interchanged. If $K_1K_2 = 10$, Y is set to 0 and each bit of X is replaced with the exclusive-OR of the corresponding bits of X and Y , that is, the new x_i is $x_i \oplus y_i$. If $K_1K_2 = 11$, X is unchanged and Y is set to all 1's.

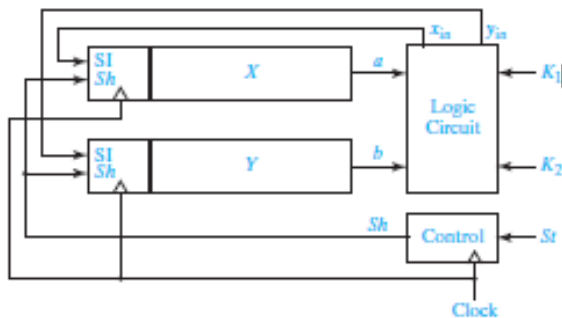

- (a) Determine logic equations for x_{in} and y_{in} .
- (b) Determine a state graph for the control circuit. Assume that once St is set to 1 it will remain 1 until all 8 bits have been processed. Then, St will be changed back to 0 some time before the start of the next computation cycle.
- (c) Construct the logic circuit using two 4-to-1 multiplexers and a minimum number of added gates.

Course Outcome 3 (CO3):

1. Compare the array structured and Hierarchical memory architectures.
2. Classify the Read write memory (RAM).
3. Describe the basic read, write and erase operation in NOR flash Memory
4. Differentiate SRAM and DRAM
5. Analyze the basic read and write operation in CMOS SRAM.

Course Outcome 4 (CO4):

1. Draw the architecture of logic cells used in Altera MAX.
2. Describe DC input and DC output schemes in Xilinx I/O block
3. List any three programmable interconnect scheme.
4. Discuss about programmable interconnect technology used in Actel ACT.
5. With diagrams, explain about programmable interconnect matrix scheme used in Xilinx EPLD.

Course Outcome 5 (CO5):

1. Define Noise-Margin.
2. Describe the characteristics of basic ECL Logic family
3. Calculate the fanout and Propagation delay of the standard TTL gate.

I_{oh}	I_{ol}	I_{ih}	I_{il}	T_{pjh}	T_{phl}
1mA	20mA	0.05mA	2mA	3ns	3ns

4. Connect the output Y of the DTL gate to N inputs of other similar gates. Assume that the output transistor is saturated and its base current is 0.44 mA.
 - i) Calculate the current in the 2kΩ load resistor.
 - ii) Calculate the current coming from each input connected to the gate.
 - iii) Calculate the total collector current in the output transistor as a function of N.
 - iv) Manipulate the value of N that will keep the transistor in saturation.
 - v) Compute the fan out of the gate?
5. Construct the circuit of four-input NAND gate using CMOS transistors.

Concept Map

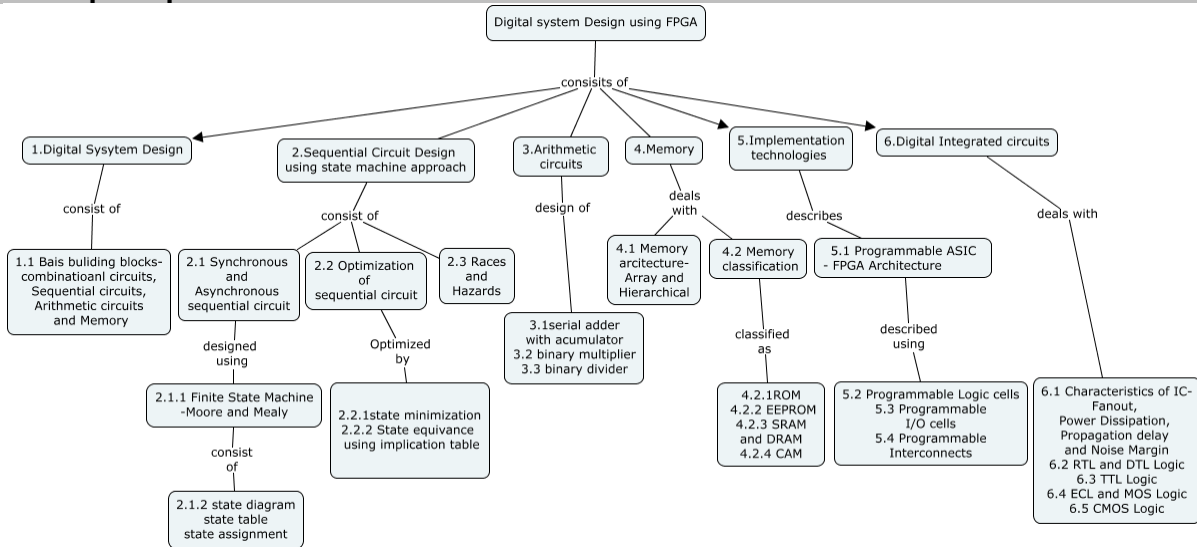

Syllabus

Digital system Design: Basic Building blocks- Combinational circuits, Sequential circuits, Arithmetic circuits, Memory

Sequential Circuit Design using state machine approach: Synchronous and Asynchronous Sequential Circuit -Finite State Machine- Moore and Mealy, State Diagram, State table, State Assignment, Optimization of sequential circuit – State Minimization – Determination of state equivalence using an implication table, Races and Hazards.

Arithmetic Circuits: Serial adder with accumulator, Design of binary multiplier, Design of binary divider.

Memory: Memory architecture types, Memory classification – ROM, EEPROM- Flash EEPROM, RAM- SRAM, DRAM and cache memory.

Implementation technologies: Programmable Logic Devices – FPGA architecture- Actel, Xilinx, Altera Programmable Logic cells, Programmable I/O cells, Programmable interconnects.

Digital Integrated circuits: Characteristics of ICs, RTL and DTL, TTL, ECL and MOS, CMOS IC families.

Text Books

1. Charles H.Roth Jr, Larry L.Kinney "Fundamentals of Logic Design", Seventh edition, Cengage Learning 2014
2. Jan M. Rabey, Anantha Chandrakasan and Borivoje Nikolic " Digital integrated circuits: A Design Perspective (2nd Edition) ", Pearson 2009

Reference Books

1. Stephen D. Brown, and Zvonko Vranesic, "Fundamentals of Digital Logic with Verilog Design, 2nd Edition," McGraw Hill, June, 2007.
2. M. Morris Mano and Michael D. Ciletti, "Digital Design: with an Introduction to the Verilog HDL", 5th Edition, Prentice Hall 2012.
3. M.J.S.Smith, "Application Specific Integrated Circuits", Pearson, 2003.
4. Clive Maxfield, "The Design Warrior's Guide to FPGAs", Elsevier, 2004.
5. Peter Ashenden, "Digital Design using Verilog", Elsevier, 2007.

Course Contents and Lecture Schedule

Module No.	Topic	No. of Lectures
1	Digital System Design	
1.1	Basic Building blocks- Combinational circuits, Sequential circuits, Arithmetic circuits, Memory	1
2	Sequential Circuit Design using state machine approach	
2.1	Synchronous and Asynchronous Sequential Circuit	1
2.1.1	Finite State Machine- Moore and Mealy	2
2.1.2	State Diagram, State table, State Assignment	2
2.2	Optimization of Sequential circuit	
2.2.1	State Minimization	2
2.2.2	Determination of state equivalence using an implication table,	2
2.3	Races and Hazards	2
	Assignment 1: Design of FSMs using HDL	
3	Arithmetic Circuits	
3.1	Serial adder with accumulator	2
3.2	Design of binary multiplier	2
3.3	Design of binary divider	2
	Assignment 2: Design of Arithmetic circuits using HDL	
4.	Memory	
4.1	Memory Architecture – Arraystructured and Hierarchical	1
4.2	Memory classification	
4.2.1	ROM	1
4.2.2	EEPROM-Flash EEPROM	1
4.2.3	RAM- SRAM, DRAM	1
4.2.4	CAM – CAM in cache memory	1
5.	Implementation technologies	
5.1	Programmable ASIC – FPGA architecture- Actel, Xilinx, Altera	2

5.2	Programmable Logic cells	2
5.3	Programmable I/O cells	2
5.4	Programmable Interconnects	2
	Assignment 3: FPGA Implementation of FSM and Arithmetic circuits.	
6.	Digital Integrated circuits	
6.1	Characteristics of ICs - Fan Out, Power dissipation, Propagation delay and Noise Margin	1
6.2	RTL and DTL	1
6.3	TTL	1
6.4	ECL and MOS	1
6.5	CMOS IC families	1
Total		36

Course Designers:

1	Dr.S.Rajaram	rajaram_siva@tce.edu
2.	Dr.K.Kalyani	K_kalyani@tce.edu
3.	Dr.V.R.Venkatasubramani	venthiru@tce.edu



14ECPD0	CONTROL SYSTEMS	Category	L	T	P	Credit
		PC	2	1	0	3

Preamble

Control Systems plays vital role in the advance of engineering and science. Automatic control has become an important and integral part of modern manufacturing and industrial processes. Advances in the theory and practice of automatic control provide the means for attaining optimal performance of dynamic systems improving productivity and reducing repetitive manual operation. In recent years there has a rapid increase in the use of digital controller in control systems. Digital controls are used for achieving optimal performance in the form of maximum productivity, maximum profit and minimum cost. Decision making capability and flexibility in the control programs are major advantages of digital control systems. The study of analog and discrete time control system prepares the student for early productivity upon entering industrial practice.

Prerequisite

14EC340 Signals and Systems
14EC440 Signal Processing

Course Outcomes

On the successful completion of the course, students will be able to

CO1. Develop a mathematical model for a given system in Laplace domain and time domain.	Apply
CO2. Compute and describe the output response and steady state error of first, second and higher order control systems for standard input signals	Apply
CO3. Compute transfer function of multiple subsystems modelled as block diagram/ signal flow graph/ state space representation	Apply
CO4. Determine the stability of a system using Routh Hurwitz/ Root locus/ Nyquist criterion.	Analyze
CO5. Find the closed loop frequency response and time response parameter given the open the loop frequency response.	Apply
CO6. Design stable analog/digital system to meet given steady state/transient response specifications.	Analyze

Mapping with Programme Outcomes

COs	PO 1	PO 2	PO 3	PO 4	PO 5	PO 6	PO 7	PO 8	PO 9	PO 10	PO 11	PO 12	PSO 1	PSO 2	PSO 3
CO1	S	M	L	-	-	-	-	-	L	L	-	-	S	L	L
CO2	S	M	L	-	-	-	-	-	L	L	-	-	S	L	L
CO3	S	M	L	-	-	-	-	-	L	L	-	L	S	L	L
CO4	S	M	L	-	-	-	-	-	L	L	-	L	S	M	L
CO5	S	M	L	-	-	-	-	-	L	L	-	L	S	M	L
CO6	S	S	M	L	-	-	-	-	L	L	-	L	S	M	L

S- Strong; M-Medium; L-Low

Assessment Pattern

Bloom's Category	Continuous Assessment Tests			Terminal Examination
	1	2	3	
Remember	20	0	0	0
Understand	20	20	20	20
Apply	60	60	60	60
Analyse	0	20	20	20

Evaluate	0	0	0	0
Create	0	0	0	0

Course Level Assessment Questions

Course Outcome 1 (CO1):

- Find the transfer function $G(s) = C(s)/R(s)$ corresponding to the differential equation $\frac{d^3c}{dt^3} + 3\frac{d^2c}{dt^2} + 7\frac{dc}{dt} + 5c = \frac{d^2r}{dt^2} + 4\frac{dr}{dt} + 3r$
- Find the transfer function relating the capacitor voltage $V_C(s)$ to the input voltage $V(s)$ in Figure.1.

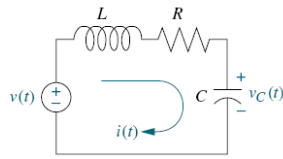

Figure.1

- Find the state space representation of the transfer function shown in Figure.2.

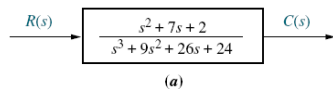

Figure.2.

Course Outcome 2 (CO2):

- Consider the unit step response of a unity feedback control system whose open loop transfer function is $G(s) = \frac{1}{s(s+1)}$. Determine the rise time, peak time, maximum overshoot and settling time.
- Compare the rise time, peak time and maximum overshoot of the following systems.
 - $\frac{C(s)}{R(s)} = \frac{36}{s^2 + 2s + 36}$
 - $\frac{C(s)}{R(s)} = \frac{16}{s^2 + 6s + 16}$
- If the step response of a network is $1 - e^{-at}$, what is the impulse response?

Course Outcome 3 (CO3):

- Simplify the block diagram shown in Figure 3, then obtain the closed loop transfer function $C(s)/R(s)$.

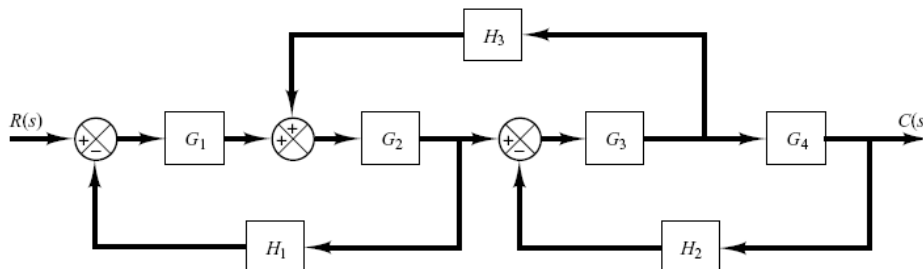

Figure.3

- Consider the signal flow graph shown in Figure 1. The gain X_5/X_1 is

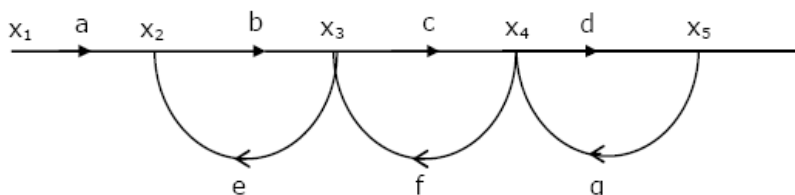

Figure 4.

- Find the closed loop transfer function $T(s) = C(s)/R(s)$ for the system shown in Figure.5. using block diagram reduction

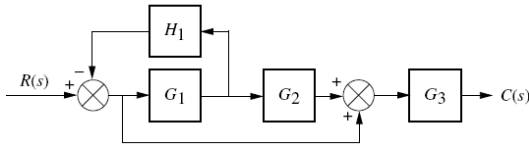

Figure.5.

Course Outcome 4 (CO4):

- How many poles are in the right half plane, in the left plane and on the $j\omega$ axis for the open loop system of Figure.6.

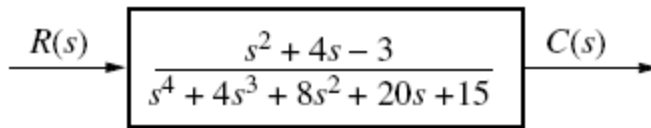

Figure.6.

- In the system of Figure.7, let $G(s) = \frac{K(s+2)}{s(s-1)(s+3)}$. Find the range of K for closed loop stability.



Figure.7.

- For the system shown in Figure.8. make an accurate plot of the root locus and find the following:
 - The breakaway and break-in points
 - The range of K to keep the system stable
 - The value of K that yields a stable system with critically damped second order poles.

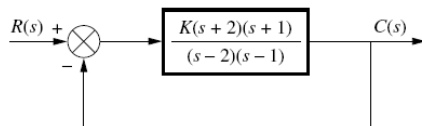

Figure.8.

Course Outcome 5 (CO5):

- Draw the Bode diagram of the transfer function $G(s) = \frac{100(s+1)}{s(s+5)}$.
- Draw the Polar plot of the transfer function $G(s) = \frac{5}{s(s+1)(s+2)}$

- Design a lag compensator by using frequency response method for the system with

$$G(s) = \frac{1}{s(s+1)(0.5s+1)}$$

Course Outcome 6 (CO6):

- Given $T(z) = N(z)/D(z)$, where $D = z^3 - z^2 - 0.5z + 0.3$, use the Routh Hurwitz criterion to find the number of z-plane poles of $T(z)$ inside, outside, and on the unit circle. Is the system stable?

- A continuous unity feedback system has a forward transfer function of

$$G(s) = \frac{1}{s(s+5)(s+8)}$$

specifications:

Percent overshoot: 10 %

Settling time: 2 seconds

Sampling interval: 0.01 second

Design a lead compensator for the digital system to meet the specifications.

- Consider a unity feedback digital control system with open loop transfer function

$$G_1(s) = K/[s(s+1)(s+3)]$$

find the value of K to yield a peak time of 2 seconds if the sampling interval $T = 0.1$ second. Find the range of K for stability.

Concept Map

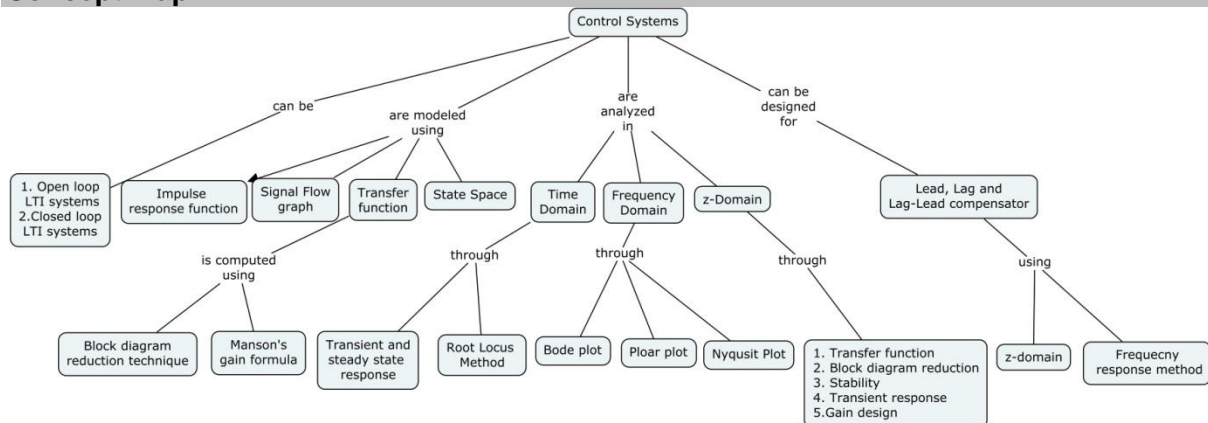

Syllabus

Modeling of Control Systems: Open loop LTI systems, Closed loop LTI systems, Modelling in Laplace Domain, Laplace transform review, transfer function, electrical network transfer function, Electric circuits analogs, Modelling in time domain, general state-space representation, converting a transfer function to state space, converting from state space to a transfer function

Time response: Poles, zeros and system response, First order systems, second order Systems, General second order systems, underdamped second order systems, Higher order systems, System response with additional poles, system response with zeros, Effects of non linearities upon time response

Reduction of multiple subsystems: Block diagrams, Analysis and design of feedback systems, signal flow graphs, Mason's rule, signal flow graph of state equation.

Stability: Routh Hurwitz criterion, Root locus techniques, Nyquist stability

Frequency response techniques: Bode plot, Nyquist diagram, Gain margin, phase margin, transient response via gain adjustment, Lag compensation, Lead compensation, Lag-Lead compensation

Digital Control systems: Modeling the digital computer, z-transforms, transfer functions, block diagram reduction, stability, transient response on the z-plane, gain design on the z-plane, Implementing the digital compensator.

Text Books

1. Norman Nise, "Control System Engineering" John Wiley & Sons, 6th Edition, 2011
2. Katsuhiko Ogata, "Modern Control Engineering", 4th Edition, Prentice Hall, 2002

Reference Books

1. Katsuhiko Ogata, "Discrete time control systems", 2nd Edition, Prentice Hall, 1995
2. M Gopal, "Control Systems Principles and Design", Tata McGraw Hill, 2002,
3. Kuo, B.C., "Automatic Control System", Prentice Hall, sixth edition, 1993.
4. B. C. Kuo, Digital Control Systems, Oxford University Press, 2/e, Indian Edition, 2007

Course Contents and Lecture Schedule

No.	Topic	No. of Lectures
1	Modeling of Control Systems	
1.1	Open loop LTI systems, Closed loop LTI systems	1
1.2	Modelling in Laplace Domain, Laplace transform review	1
1.3	Transfer function	1
1.4	Electrical network transfer function	1
1.5	Electric circuits analogs	1
1.6	Modelling in time domain, general state-space representation	1
1.7	Converting a transfer function to state space	1
1.8	Converting from state space to a transfer function	1
1.9	Tutorial	1
2	Time response	
2.1	Poles, zeros and system response	1
2.2	First order systems, second order Systems	2
2.3	General second order systems, underdamped second order systems	1
2.4	Higher order systems	1
2.5	System response with additional poles	1
2.6	system response with zeros	1
2.7	Effects of non linearities upon time response	1
2.8	Tutorial	1
3	Reduction of multiple subsystems	
3.1	Block diagrams	2
3.2	Analysis and design of feedback systems	1
3.3	signal flow graphs	2
3.4	Mason's rule	1
3.5	signal flow graph of state equation	1
3.6	Tutorial	1
4	Stability	
4.1	Routh Hurwitz criterion	2
4.2	Root locus techniques	2
4.3	Nyquist stability	1
4.4	Tutorial	1
5	Frequency response techniques	
5.1	Bode plot	2
5.2	Nyquist diagram	1
5.3	Gain margin, phase margin	1
5.4	Transient response via gain adjustment	1

5.5	Lag compensation	1
5.6	Lead compensation	1
5.7	Lag-Lead compensation	1
5.8	Tutorial	1
6	Digital Control systems	
6.1	Modeling the digital computer, z-transforms, transfer functions	1
6.2	block diagram reduction, stability	2
6.3	transient response on the z-plane	1
6.4	gain design on the z-plane	1
6.5	Implementing the digital compensator	1
6.6	Tutorial	1
	Total	48

Course Designers:

1	Dr.S.J.Thiruvengadam	sitece@tce.edu
2.	Dr.P.G.S.Velmurugan	pgsvels@tce.edu



14ECPE0	DATA STRUCTURES AND ALGORITHMS	Category	L	T	P	Credit
		PC	2	0	2	3

Preamble

For an Engineer, solving any real time problem is not just about designing an algorithm and solving it, but has the ability to select appropriate data structures and solve the problem efficiently. This course on data structures introduce abstract concepts for data organization and manipulation using data structures such as stacks, queues, linked lists, binary and multi-way trees, heaps and graphs.

Prerequisite

14EC320 : Problem Solving using Computer

14EC380 : Computer Programming Lab

Course Outcomes

On the successful completion of the course, students will be able to

CO1	Understand the need for Abstract Data Types (ADT) in data organisation and manipulation, types of ADTs, its memory representation and asymptotic measures of using different ADTs in different algorithms.	Understand
CO2	Implement operations such as insert, search, modify and delete in linear and nonlinear data structures such as stack, queue, linked lists, binary and multi-way trees and priority queues.	Apply
CO3	Solve problems using the fundamental graph algorithms, including Depth-First and Breadth-First search, topological sort, minimum spanning tree algorithm and shortest path algorithm. first	Apply
CO4	Select appropriate data structures for solving real time problems.	Analyze
CO5	Analyze time complexity of various searching algorithms like open and closed hashing techniques and sorting algorithm like insertion, shell, merge and quick sorts.	Analyze

Mapping with Programme Outcomes

COs	PO 1	PO 2	PO 3	PO 4	PO 5	PO 6	PO 7	PO 8	PO 9	PO 10	PO 11	PO 12	PSO 1	PSO 2	PSO 3
CO1	M	-	-	-	-	-	-	-	L	M	-	L	L	-	-
CO2	S	M	L	-	S	-	-	M	S	M	-	M	M	L	M
CO3	S	M	L	-	S	-	-	M	S	M	-	M	M	L	M
CO4	S	S	M	-	S	-	-	M	S	M	-	M	S	L	L
CO5	S	S	M	-	S	-	-	M	S	M	-	M	S	L	L

S- Strong; M-Medium; L-Low

Assessment Pattern

Bloom's Category	Continuous Assessment Tests			Terminal Examination
	1	2	3	
Remember	10	10	Practical	10
Understand	10	10		10
Apply	60	50		50
Analyse	20	30		30
Evaluate	0	0		0
Create	0	0		0

Course Level Assessment Questions**Course Outcome 1 (CO1):**

1. A hospital maintains a patient file in which each record contains the following data: Name, Admission Data, Social security Number, Room, Bed Number, Doctor incharge.
 - (a) which items can serve as primary key?
 - (b) Which pair of items can serve as primary keys?
 - (c) Which item can be group items?
2. Suppose a data set S contains n elements. Compare the running time T1 of the linear search algorithm with the running time T2 of the binary search algorithm when n=1000 and n=10000.
3. Find the complexity of the following program segment.

```

fun(n)
{
  if (n<=2)
    return(1);
  else
    return((fun(n-1)*fun(n-1)));
}
      
```

Course Outcome 2 (CO2):

1. Design a stack such that getMinimum() is O(1).
2. Write a program to reverse the elements of stack only using stack operations.
3. Implement the algorithm for getting the k-th to the last element in the linked list.
4. Write a function to check whether two BSTs are structurally identical.
5. Write a function to find the size of a Binary Search Tree.

Course Outcome 3 (CO3)

1. Given a directed graph, give an algorithm to detect whether there is a cycle.
2. Given an undirected graph, give an algorithm to detect whether there is a cycle.
3. Given a directed acyclic graph, give an algorithm to topologically sort the nodes.
4. Write a program to implement Kruskal's algorithm.

Course Outcome 4 (CO4)

1. Given an arithmetic expression, develop an algorithm to check for matching parenthesis and choose an appropriate data structure to implement the algorithm efficiently.
2. Analyze the efficiency of using singly linked list and doubly linked list for checking whether a given text is palindrome or not.
3. A big chain of supermarkets sell millions of products. Each of them has a unique number (barcode), producer, name and price. What data structure could we use in order to quickly find all products, which cost between Rs. 500 and Rs. 1000?
4. A timetable of a conference hall is a list of events in a format [starting date and time; ending date and time; event's name]. What data structure could we to be able to quickly add events and quickly check whether the hall is available in a given interval [starting date and time; ending date and time]?

Course Outcome 5 (CO5)

1. Sort the sequence 3, 1, 4, 1, 5, 9, 2, 6, 5 using insertion sort. Analyze the time complexity of insertion sort if all keys are equal?
2. Show the result of running Shell sort on the input 9, 8, 7, 6, 5, 4, 3, 2, 1 using the increments { 1, 3, 7 } and increments {1,2}.
3. Given input {4371, 1323, 6173, 4199, 4344, 9679, 1989} and a hash function $h(x) = x(\text{mod } 10)$, analyze the performance of hashing done by
 - a. open hashing
 - b. closed hashing using linear probing
 - c. closed hashing using quadratic probing

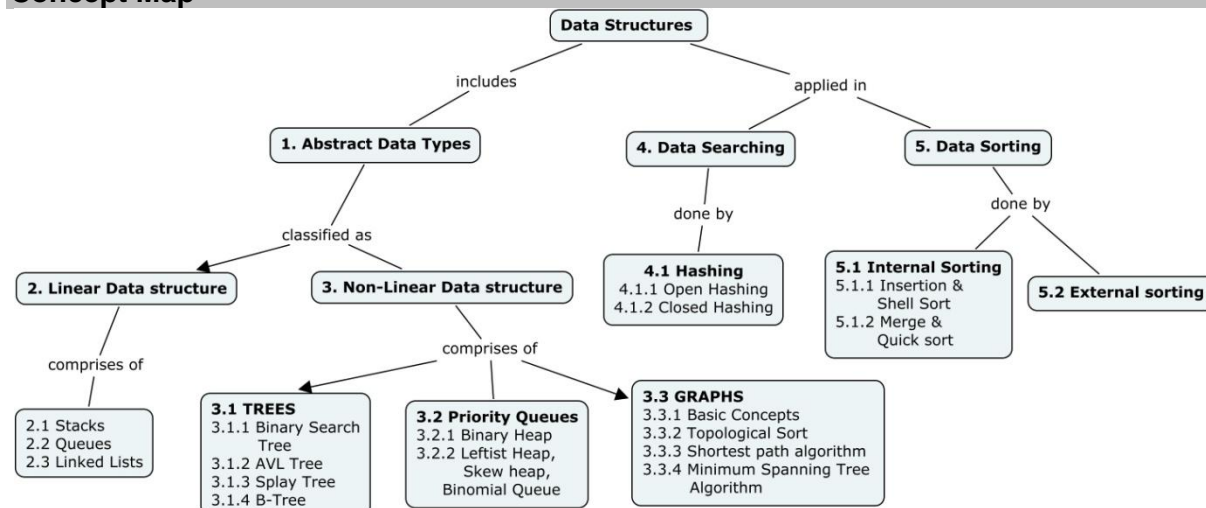
Concept Map**Syllabus**

Introduction to Data Structures: Abstract Data Types (ADT's) - Asymptotic Measures, **Linear Data Structures:** Stacks – Queues - Linked Lists: Singly Linked List – Doubly Linked List – Circular Linked List, **Nonlinear Data Structures:** **Trees:** Binary Tree – Binary Search tree - AVL tree - Splay Tree - B-tree, **Priority Queues:** Binary Heaps - Skew heap –Leftist Heap – Binomial Queue, **Graphs:** Basic Concepts - Topological Sort - Shortest Path Algorithm - Minimum Spanning Tree algorithm, **Data Searching: Hashing:** Open Hashing - Closed Hashing, **Data Sorting: Internal Sorting:** Insertion Sort, shell Sort, Merge Sort, Quick Sort, **External Sorting**

List of Laboratory Experiments:

1. Implement basic operations of Stacks
2. Infix to Postfix conversion using Stacks
3. Implement basic operations of Queues
4. Round Robin Scheduling using Queues
5. Polynomial addition using Linked Lists
6. Implement insertion, deletion and searching operations in Binary Search Tree
7. Implement insertion, deletion and display operation in Binary Heaps
8. Searching using Hashing Techniques
9. Sorting using merge and quick sort algorithms
10. Implement Minimum Spanning Tree Algorithm
11. Implement Shortest Path routing using Dijkstra's Algorithm

Text Books

1. Richard F. Gilberg, Behrouz A. Forouzan, "Data Structures: A Pseudocode Approach with C", 2nd Edition, Thomson Learning, 2003.
2. Mark Allen Weiss, "Data Structures and Algorithm Analysis in C++ ", 4th edition, Pearson Education, 2014.

Reference Books

1. Michael T., Goodrich, "Data Structures and Algorithms in C++", 2nd edition, John Wiley, 2012.
2. Larry R. Nyhoff, "ADTs, Data Structures, and Problem Solving with C++", Pearson Education, 2005.
3. Robert L. Kruse, "Data Structures and Program Design in C++", Pearson Education, 2000.
4. Lipschutz and G.A.V. Pai, "Data Structures with C", Tata McGraw-Hill, 2010.
5. ISRD Group, "Data Structures using C", Tata McGraw-Hill, 2010.

Course Contents and Lecture Schedule

Module No.	Topic	No. of Lectures
1.	INTRODUCTION TO DATASTRUCTURES	
1.1	Abstract Data Types (ADT's)	1
1.2	Asymptotic Measures	1
2.	LINEAR DATASTRUCTURES	
2.1	Stacks	1
2.2	Queues	1
2.3	Linked Lists: Singly Linked List – Doubly Linked List – Circular Linked List	2
3.	NONLINEAR DATASTRUCTURES	
3.1	TREES	
3.1.1	Binary Tree – Binary Search Tree	2
3.1.2	AVL tree	1
3.1.3	Splay Tree	1
3.1.4	B-tree	1
3.2	PRIORITY QUEUES	
3.2.1	Binary Heaps	2
3.2.2	Specialized Heaps (Skew , Leftist, Binomial)	1
3.3	GRAPHS	
3.3.1	Basic Concepts	1
3.3.2	Topological Sort	1
3.3.2	Shortest Path Algorithm	1
3.3.3	Minimum Spanning Tree Algorithm	1
4	DATA SEARCHING	
4.1	HASHING	
4.1.1	Open Hashing	1
4.1.2	Closed Hashing	1
5	DATA SORTING	
5.1	Internal Sorting	
5.1.1	Insertion Sort, Shell Sort	1
5.1.2	Merge Sort, Quick Sort	2
5.2	External Sorting	1
	Theory	24
	Practical	24
	Total	48

Course Designers:

1	Dr. S. Ponmalar	spmece@tce.edu
2	Mr. S. Prasanna	sprcse@tce.edu

14ECPF0	REAL TIME SYSTEM DESIGN
----------------	--------------------------------

Category	L	T	P	Credit
PE	3	0	0	3

Preamble

A real-time operating system (RTOS) is an operating system that guarantees a certain capability within a specified time constraint. Real-time operating systems are created for a special application. Some of existing general purpose operating systems claims to be real-time operating systems. In general, real-time operating systems are required to have multitasking, prioritized process threads and sufficient number of interrupt levers. Real-time operating systems are often required in small embedded operating systems that are packaged as part of micro-devices. The kernel programs can be considered to meet the requirements of a real-time operating system. However, since other components, such as device drivers, are also usually needed for a particular solution, a real-time operating system is usually larger than just the kernel. The modules are organized as follows: The first two modules will cover about the fundamentals of operating system. Design consideration of programs is analyzed in the third module. Fourth module consists of case study and application. Validation and testing is the end of the modules.

Prerequisite

14EC420 Microcontroller

Course Outcomes

On the successful completion of the course, students will be able to

CO1: List and describe the OS and RTOS	Remember
CO2: Distinguish Understand the difference between general purpose computing operating system and a real-time operating system	Remember
CO3: Illustrate the effectiveness of RTOS over conventional	Understand
CO4: Develop multitasking coding for multiple task handling	Apply
CO5: Apply the concepts of small operating system with real time aspect for a system	Apply
CO6: Develop an embedded system for data acquisition and Monitoring	Apply

Mapping with Programme Outcomes

COs	PO 1	PO 2	PO 3	PO 4	PO 5	PO 6	PO 7	PO 8	PO 9	PO 10	PO 11	PO 12	PSO 1	PSO 2	PSO 3
CO1	M	L	-	-	-	-	-	L	M	L	-	-	L	-	-
CO2	M	L	-	-	-	-	-	L	M	L	-	-	L	-	-
CO3	S	M	L	-	-	-	-	L	M	L	-	L	M	-	L
CO4	S	M	L	-	-	-	-	L	M	L	-	L	M	-	L
CO5	S	M	L	-	-	-	-	M	L	L	-	L	M	-	L
CO6	S	M	L	-	-			L	M	L		L	M		L

S- Strong; M-Medium; L-Low

Assessment Pattern

Bloom's Category	Continuous Assessment Tests			Terminal Examination
	1	2	3	
Remember	20	20	20	20
Understand	40	40	40	40
Apply	40	40	40	40
Analyse	0	0	0	0
Evaluate	0	0	0	0
Create	0	0	0	0

Course Level Assessment Questions

Course Outcome 1 (CO1):

1. Define a real-time system.
2. What is meant by interrupt latency?
3. What is meant by time relative buffering?
4. What is meant by scheduling?

Course Outcome 2 (CO2)

1. Demonstrate various scheduler functions
2. How co-routine function performs?
3. What is a system call? Where it is implemented?.
4. How thrashing affects the performance of the OS?
5. Draw the state transition diagram of task-control block model system and explain the task management.

Course Outcome 3(CO3):

1. Demonstrate the RTOS tasking operation
2. Give an example for accessing queues
3. Describe the use of IPC
4. Develop a C program for a passing message to another task

Course Outcome 4 (CO4):

1. Compare the functions of base class to a derived class.
2. Why is not wise to disable interrupts before the while statement in the binary semaphore
3. Why context switching is needed in OS function?
4. Investigate the critical section function along with different threads of a Real Time Operating System.
5. Examine the RTOS function in dead lock situation between multiple tasks

Course Outcome 5 (CO5):

1. Find out the average waiting time for the following processes

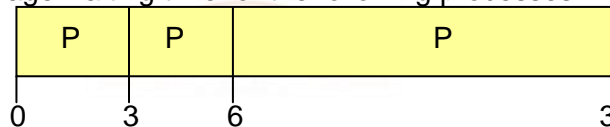

2. Develop c code to implement a semaphore
3. Develop a c code to implement a ring buffer
4. Write program codes to demonstrate the function of inter process communication.

Concept Map

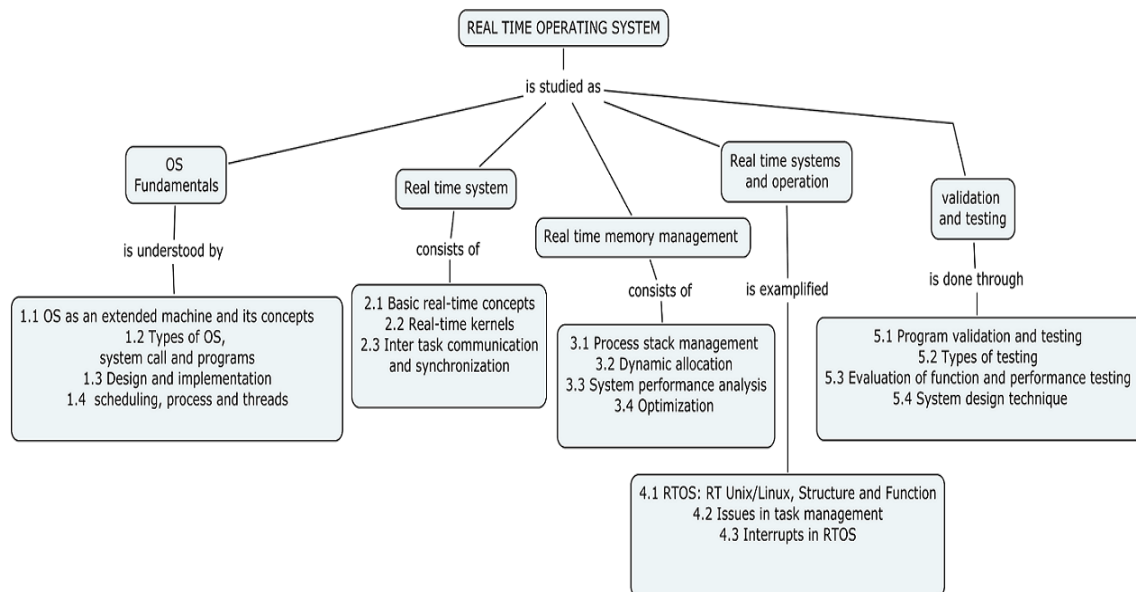

Syllabus

OS fundamentals and functions: OS as an extended machine and its concepts, Types of OS, system call and programs, System structure: Design and implementation. **Real-time systems:** Concepts and scheduling, Co-operative process and IPC, Threads overview, Multithreading models. **Real time memory management:** Process stack management, Dynamic allocation, and System performance analysis **Real-Time operating systems:** RT Unix/Linux, Structure and Function, Issues in task management and Interrupts in RTOS. **Validation and testing:** Program validation and testing, Types of testing, Evaluation of function and performance testing, System design technique.

Text Books

1. Silberschatz, Galvin, Gagne, "Operating Systems Concepts", Sixth edition – John Wiley & Sons – Indian edition –2002.
2. Philip A. Laplante, "Real time systems Analysis and Design – An Engineer's Handbook", IEEE computer society press PHI, 2ndEd. 1997.
3. Allan. V. Shaw, "Real Time systems and software", John Wiley & Sons.

Reference Books

1. Stephen B.Furber, "ARM system architecture", Addison Wesley 1996.
2. Wayne Wolf, "Computers as Components: Principles of Embedded Computing System Design", Elsevier Inc ,2001.
3. C.M. Krishna, Kang G. Shin, "Real-Time Systems", McGraw – Hill International Editions, 1997.

Course Contents and Lecture Schedule

Module No.	Topic	No. of Lectures
1	OS fundamentals and functions	
1.1	OS as an extended machine and its concepts	2
1.2	Types of OS, system call and programs	2
1.3	System structure: Design and implementation	2
1.4	Concepts of scheduling, process and threads	2
2	Real-time systems	
2.1	Basic real-time concepts	2
2.2	Real-time kernels	3
2.3	Inter task communication and synchronization	3
3	Real time memory management	
3.1	Process stack management	2
3.2	Dynamic allocation	2
3.3	System performance analysis	2
3.4	Optimization	2
4	Real-Time operating systems	
4.1	Real time OS: RT Unix/Linux, Structure and Function	4
4.2	Issues in task management	2
4.3	Interrupts in RTOS	2
5	Validation and testing	
5.1	Program validation and testing	2
5.2	Types of testing	2
5.3	Evaluation of function and performance testing	2
5.4	System design technique	2
	Total	40

Course Designers:

1. Dr.K. Hariharan khh@tce.edu
2. Dr.L.R.Karl Marx lkarlmarx@tce.edu

14ECPG0	STATISTICAL SIGNAL PROCESSING	Category	L	T	P	Credit
		PE	2	1	0	3

Preamble

This course aims at developing Estimation and Detection Algorithms for scalar and vector parameters of a system in noise. Further, it also aims at developing algorithms for detecting the desired signals from the noisy received signal.

Prerequisite

14EC440 Signal Processing

Course Outcomes

On the successful completion of the course, students will be able to

CO1. Formulate the estimation problem and determine the CRLB for the given estimation problem.	Understand
CO2. Design an estimator based on maximum likelihood, maximum a posteriori, least square and minimum mean square error methods.	Apply
CO3. Formulate the detection problem	Understand
CO4. Detect known signal in Gaussian noise using matched filter and generalized matched filter.	Apply
CO5. Detect Random signal in Gaussian noise using estimator correlator and design detectors for array processing applications.	Apply

Mapping with Programme Outcomes

COs	PO 1	PO 2	PO 3	PO 4	PO 5	PO 6	PO 7	PO 8	PO 9	PO 10	PO 11	PO 12	PSO 1	PSO 2	PSO 3
CO1	S	M	L	-	-	-	-	-	L	L	-	L	S	M	L
CO2	S	M	L	-	-	-	-	-	L	L	-	L	S	M	L
CO3	S	M	L	-	-	-	-	-	L	L	-	L	S	M	L
CO4	S	M	L	-	-	-	-	-	L	L	-	L	S	S	L
CO5	S	S	M	L	-	-	-	-	L	L	-	L	S	S	L

S- Strong; M-Medium; L-Low

Assessment Pattern

	Bloom's category	Continuous Assessment Tests			End Semester Examinations
		1	2	3	
1	Remember	20	20	10	10
2	Understand	20	20	10	10
3	Apply	60	60	80	80
4	Analyze	0	0	0	0
5	Evaluate	0	0	0	0
6	Create	0	0	0	0

Course Level Assessment Questions**Course Outcome 1 (CO1):**

1. In Bayesian estimator, if the cost function is absolute error, the estimator is defined to be the median of the posterior PDF. Justify
2. Can an optimal estimator be obtained from CRLB? Explain
3. Compare the estimation performance of ML, MAP and MMSE based estimators. When an estimator is said to be unbiased?

Course Outcome 2 (CO2):

- The data $x(n) = Ar^n + w(n)$ for $n = 0, 1, \dots, N-1$ are observed, where $w(n)$ is WGN with variance σ^2 and $r > 0$ is known.
 - Find the CRLB for A.
 - Show that an efficient estimator exists and find its variance.
- Consider the observations $x(n) = A + w(n)$ $n = 0, 1, \dots, N-1$, where A is real number and $w(n)$ is WGN with variance σ^2 . Let the estimator $\hat{A} = \frac{1}{N} \sum_{n=0}^{N-1} x(n)$. Prove that the PDF \hat{A} is $N(A, \sigma^2 / N)$

3. MAP Estimator:

- Assume that the conditional PDF $p(x[n] | \theta) = \theta \exp(-\theta x(n))$ $x[n] > 0$ where the $x[n]$'s are independent and identically distributed and the prior PDF is $p(\theta) = \lambda \exp\{-\lambda\theta\}$ $\theta > 0$. Determine MAP estimator for θ .

- The data $x(n) = A + w(n)$ for $n = 0, 1, \dots, N-1$ are observed, where A is unknown and the noise variance σ^2 is also unknown. The conditional PDF

$$p(\mathbf{x} / A, \sigma^2) = \frac{1}{(2\pi\sigma^2)^{N/2}} \exp\left(-\frac{1}{2\sigma^2} \sum_{n=0}^{N-1} (x(n) - A)^2\right).$$

$$p(\theta) = \frac{\lambda \exp\left(-\frac{\lambda}{\sigma^2}\right)}{\sigma^4} \quad \sigma^2 > 0$$

Course Outcome 3 (CO3):

- Detection performance is monotonic with deflection coefficient. Justify this statement.
- For the DC level in WGN detection problem assume that we wish to have $P_{FA} = 10^{-4}$ and $P_D = 0.99$. If the SNR is $10 \log_{10} A^2 / \sigma^2 = -30$ dB, determine the necessary number of samples N .
- Explain the function of 'Clairvoyant Detector'?

Course Outcome 4 (CO4):

- A radar signal $s[n] = A \cos 2f_0 n$ for $n = 0, 1, \dots, N-1$ is received embedded in WGN with variance $\sigma^2 = 1$. A detector is to be designed that maintains $P_{FA} = 10^{-8}$. If $f_0 = 0.25$ and $N = 25$, find the probability of detection versus A.
- Consider the detection of $s[n] = A \cos 2f_0 n$ for $n = 0, 1, \dots, N-1$ in the presence of WGN with variance σ^2 . Define the input SNR as the average power of a signal sample to the noise power. This is approximately $\eta_{in} = \left(\frac{A^2}{2}\right) / \sigma^2$. Find the output SNR of a matched and hence the PG. Next determine the frequency response of the matched filter and plot its magnitude as N increases. Explain why the matched filter improves the detectability of a sinusoid. Assume that $0 < f_0 < 1/2$ and N is large.
- In a Pulse Amplitude Modulation (PAM) communication system we transmit one of M levels so that $s_i[n] = A_i, n = 0, 1, \dots, N-1$, for $i = 0, 1, \dots, M-1$. If P_e is to be minimized and each signal is equally likely to be transmitted, find the optimal receiver for WGN of variance σ^2 .

Course Outcome 5 (CO5):

1. The output of an array of sensors is observed. There are $M=2$ sensors and $N=3$ samples with $\{1,2,3\}$ being observed at the output of the first sensor and $\{4,5,6\}$ being observed at the output of the second sensor. Find $\bar{x}[n]$, \bar{x}_m .
2. A sinusoidal random process is observed at the output of an array as $\tilde{x}_m[n] = \bar{A} \exp[j(2\pi(f_0 m + f_1 n) + \phi)]$ where \bar{A} is deterministic and ϕ is a random variable with $\phi \sim u[0, 2\pi]$. Show that the cross-correlation between sensors m and m' is $r_{mm'}[k] = |\bar{A}|^2 \exp[j2\pi(f_0(m'-m) + f_1(k))]$.
3. For a complex Gaussian random signal with mean zero and known covariance matrix $C_s = \sigma_s^2 \mathbf{I}$ embedded in CWGN with known variance σ^2 , find the NP detection statistic. Explain your results.

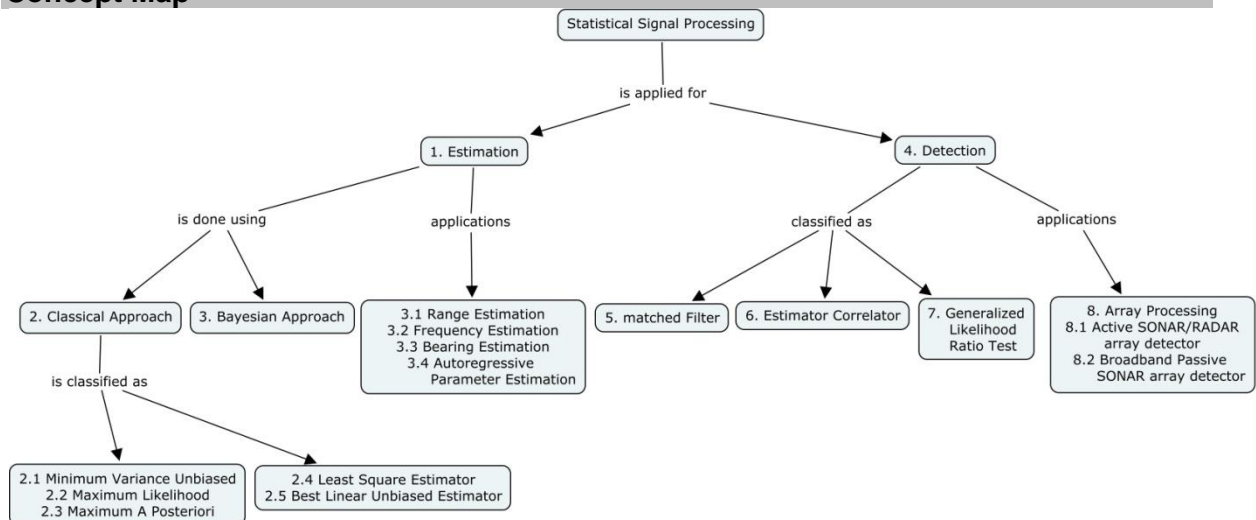
Concept Map**Syllabus**

Estimation: Mathematical Estimation problem, Assessing Estimator Performance, **Estimation Algorithms-Classical Approach:** Minimum Variance Unbiased Estimation, CRLB, Maximum Likelihood Estimation, Expectation Maximization Algorithms, Maximum a Posteriori Estimator, Least Square Estimator, Best Linear Unbiased Estimation **Estimation Algorithms-Bayesian Estimator, Signal Processing Examples:** Range Estimation, Frequency, Estimation, Bearing Estimation, Autoregressive Parameter Estimation **Detection Algorithms:** Classical Approach-Neyman Pearson Theorem, Bayesian Approach-Minimization of Bayes Risk, Receiver Operating Characteristics, **Matched Filter:** Generalized Matched Filter, Multiple Signal, Estimator Correlator, Generalized Likelihood Ratio Test: Composite Hypothesis Testing, Multiple Hypothesis Testing Detector for Array Processing, Detectors for Array Processing Applications, Active SONAR/RADAR array detector and Broadband Passive Array detector.

Text Books

1. Steven M.Kay, "Fundamentals of Statistical Signal Processing", Vol I Estimation Theory, Prentice Hall Inc, 1998
2. Steven M.Kay, "Fundamentals of Statistical Signal Processing", Vol II Detection Theory, Prentice Hall Inc, 1998,

Reference Books

1. Monson H.Hayes, "Statistical Digital Signal Processing and Modeling", John Wiley, 1996
2. Sophocles. J. Orfanidis: "Optimum Signal Processing An Introduction", Collier Macmillan, 2nd edition 1998
3. John G. Proakis, Vinay K.Ingle, Stephen M.Kogon: "Statistical and adaptive signal Processing: spectral estimation, signal modeling, adaptive filtering, and array processing", McGraw-Hill, 2000.

Course Contents and Lecture Schedule

No.	Topic	No. of Lectures
1	Estimation	
1.1	Mathematical Estimation Problems	1
1.2	Assessing Estimator Performance	1
2	Estimation Algorithms- Classical Approach	
2.1	Minimum Variance Unbiased Estimation	2
2.2	Maximum Likelihood Estimation	2
2.3	Maximum A Posteriori Estimation	2
2.4	Least Square Estimation	2
2.5	Best Linear Unbiased Estimation	2
3	Estimation Algorithms- Bayesian Approach	3
3.1	Signal Processing Examples	
3.1.1	Range Estimation	2
3.1.2	Frequency Estimation	1
3.1.3	Bearing Estimation	1
3.1.4	Autoregressive Parameter Estimation	1
4	Detection Algorithms	2
4.1	Classical Approach -Neyman Pearson Theorem	2
4.2	Bayesian Approach-Minimization of Bayes Risk	2
4.3	Receiver Operating Characteristics	1
4.3	Examples	2
5	Matched Filter	3
5.1	Generalized Matched Filter	2
5.2	Multiple Signal Detection	2
5.3	Examples	2
6.	Estimator Correlator	3
6.1	Examples	3
7	Generalized Likelihood Ratio Test	2
7.1	Composite Hypothesis Testing	2
7.2	Multiple Hypothesis Testing	2
7.3	Examples	2
8	Detectors for Array Processing Applications	2
8.1	Active SONAR/RADAR array detector	3
8.2	Broadband Passive SONAR array detector	3
Total		48

Course Designers:

1. Dr. S.J. Thiruvengadam sjtece@tce.edu
2. Dr.V.N. Senthil Kumaran vnsenthilkumaran@tce.edu

14ECPH0	RADAR SYSTEMS	Category	L	T	P	Credit
		PE	3	0	0	3

Preamble

The course Radar Systems is offered as an elective subject. This course provides in-depth coverage of fundamental topics in radar signal processing from a digital signal processing perspective. The techniques of linear systems, filtering, sampling, and Fourier analysis techniques and interpretations are used in this course to provide a unified approach in improving probability of detection and Signal to interference ratio.

Prerequisite

14EC440: Signal Processing

Course Outcomes

On the successful completion of the course, students will be able to

CO1. Identify the concepts of radar measurements, radar functions and range equation	Understand
CO2. Apply the clutter model in radar environment	Apply
CO3. Apply the detection rules/tests such as Neyman-Pearson principle, Likelihood ratio test for RADAR signal processing.	Apply
CO4. Apply CFAR detector to improve the detection performance of Radar.	Apply
CO5. Process slow time data in a given range bin to analyze the Doppler content of the signal.	Apply
CO6. Analyze various waveform modulations used in modern radar	Analyze

Mapping with Programme Outcomes

COs	PO 1	PO 2	PO 3	PO 4	PO 5	PO 6	PO 7	PO 8	PO 9	PO 10	PO 11	PO 12	PSO 1	PSO 2	PSO 3
CO1	M	L	-	-	-	-	-	-	L	L	-	-	S	L	L
CO2	S	M	L	-	-	-	-	-	L	L	-	-	S	L	L
CO3	S	M	L	-	-	-	-	-	L	L	-	L	S	L	L
CO4	S	M	L	-	-	-	-	-	L	L	-	L	S	M	L
CO5	S	S	M	L	-	-	-	-	L	L	-	L	S	M	L
CO6	S	S	M	L	-	-	-	-	L	L	-	L	S	M	L

S- Strong; M-Medium; L-Low

Assessment Pattern

Bloom's Category	Continuous Assessment Tests			Terminal Examination
	1	2	3	
Remember	0	0	0	0
Understand	20	20	20	20
Apply	80	80	60	60
Analyse	0	0	20	20
Evaluate	0	0	0	0
Create	0	0	0	0

Course Level Assessment Questions**Course Outcome 1(CO1):**

5. Find an expression for the range of a target in kilometres (km) for a reflected signal that returns to the radar $\Delta T \mu s$ after being transmitted.
6. A radar systems provides 18 dB SNR for a target having an RCS of 1 square meter at a range of 50 km. Ignoring the effects of atmospheric propagation loss, determine the range at which the SNR be 18 dB if the target RCS is reduced to:
 - a. 0.5 square meters
 - b. 0.1 square meters.
7. A system has a single pulse SNR of 13 dB for a given target at a given range. Determine the integrated SNR if 20 pulses are coherently processed.

Course Outcome 2 (CO2):

1. A radar has a pulse length of $\tau = 10\mu s$, an azimuth beamwidth $\theta_3 = 3^\circ$, and an elevation beamwidth $\phi_3 = 3^\circ$. At what grazing angle δ does the transition occur between the pulse limited and beam limited ground clutter cases when the nominal range to the ground is $R = 10\text{ km}$?
2. Consider two radar targets with polarization scattering matrices \mathbf{S}_1 and \mathbf{S}_2 as follows:

$$\mathbf{S}_1 = \begin{bmatrix} 1 & 0 \\ 0 & 1 \end{bmatrix}, \mathbf{S}_2 = \begin{bmatrix} 1 & j \\ -j & -1 \end{bmatrix}$$
 where $j = \sqrt{-1}$. Compute the parallel/cross-polarization ratio and the vertical/horizontal polarization ratio for each target. Which ratio could be used to discriminate between the two targets?
3. Show that the Weibull distribution reduces to the exponential distribution when $b=1$ and to the Rayleigh distribution when $b=2$.

Course Outcome 3 (CO3)

4. We observe the IID samples $x(n)$ for $n = 0, 1, \dots, N-1$ from the Rayleigh PDF

$$p(x[n]) = \frac{x[n]}{\sigma^2} \exp\left(-\frac{1}{2} \frac{x^2[n]}{\sigma^2}\right). \text{ Derive the NP test for the hypothesis testing}$$

$$\text{problem } \begin{aligned} H_0 &: \sigma^2 = \sigma_0^2 \\ H_1 &: \sigma^2 = \sigma_1^2 > \sigma_0^2 \end{aligned}$$

5. Consider the detection problem

$$H_0 : x(n) = 1 + w(n), \quad n = 0, 1, \dots, N-1$$

$$H_1 : x(n) = -1 + w(n), \quad n = 0, 1, \dots, N-1$$

$w(n)$ is WGN with variance σ^2 and is independent of the signal. Apply NP detector to decide H_1 . Find the Probability of error.

6. Consider the detection of a signal $s[n]$ embedded in WGN with variance σ^2 based on the observed samples $x[n]$ for $n = 0, 1, \dots, 2N-1$. The signal is given by

$$s[n] = \begin{cases} A & n = 0, 1, \dots, N-1 \\ 0 & n = N, N+1, \dots, 2N-1 \end{cases} \text{ under } H_0 \text{ and by}$$

$$s[n] = \begin{cases} A & n = 0, 1, \dots, N-1 \\ 2A & n = N, N+1, \dots, 2N-1 \end{cases} \text{ under } H_1. \text{ Assume that } A > 0.$$

- a. Determine the NP detector
- b. Determine the probability of detection P_D . In what way, instruction alignment unit supports program sequencer?

Course Outcome 4 (CO4):

1. The Neyman-Pearson threshold is set to achieve a $P_{FA} = 10^{-6}$. The interference power level changes by 6 dB. What is the new P_{FA} if the threshold remains unchanged?
2. Calculate the average P_D for a CA-CFAR with $N = 20$ and $P_{FA} = 10^{-4}$ in a homogenous environment. Assume the target in the CUT has SINR=22 dB.
3. For a CA-CFAR, calculate the SINR required to achieve a $P_D = 0.95$, with $N = 16$ and $P_{FA} = 10^{-4}$ in a homogeneous environment.

Course Outcome 5 (CO5):

4. In terms of the radar wavelength λ , what is the two way range change between pulses when the target Doppler shift equals the blind speed f_b ?
5. Consider a pulse to pulse staggered PRF system using a series of P=3 PRFs, namely, [10 kHz, 12 kHz, 15kHz].
 - a. What is the first blind Doppler frequency of a constant PRF system having the same average PRI as the staggered system?
6. Discuss the threshold settings in two parameters CFAR and distributed CFAR.

Course Outcome 6 (CO6):

4. Determine the autocorrelation function of the 11-length Barker sequence
5. Determine the matched filter output for Frank code with M=2.
6. Consider the signal shown in figure
 - a. Determine the impulse response of the matched filter
 - b. Plot the matched filter output as a function of time. What is the peak value at the output?

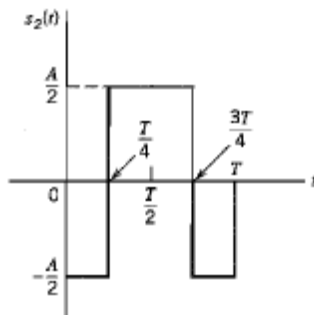

Concept Map

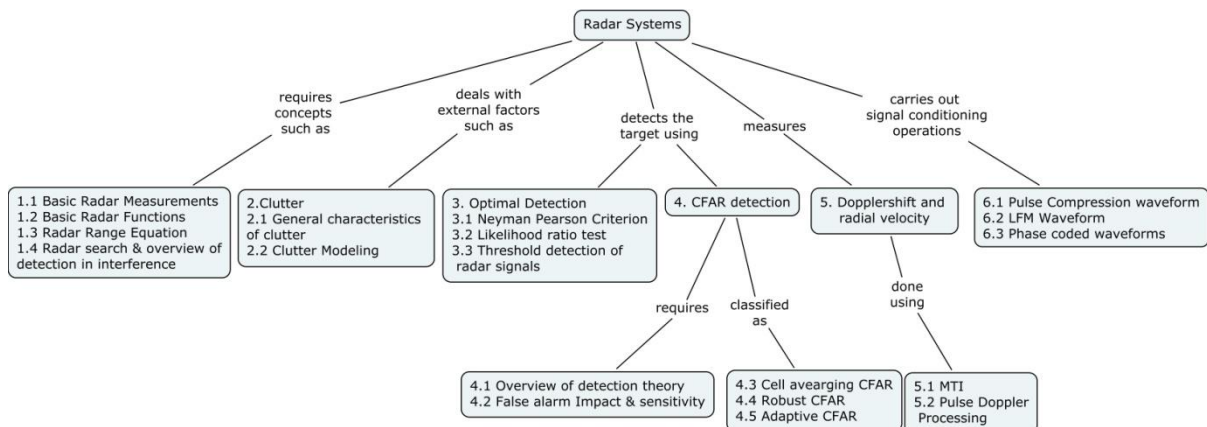

Syllabus

Radar: Radar concept, basic radar measurements, basic radar functions, radar range equation: Amplitude model, simple point target radar range equation, distributed target radar range equation, noise model and signal to noise ratio, search mode fundamentals, overview of detection fundamentals

Characteristics of Clutter: General characteristics of clutter and clutter modelling

Threshold detection of radar targets: Detection strategies for multiple measurements, Introduction to optimal detection: Hypothesis testing and Neyman-Pearson criterion, statistical models for noise and target RCS in radar, threshold detection of radar signals.

Constant False Alarm Rate Detectors: Overview of detection theory, false alarm impact and sensitivity, CFAR detectors, Cell averaging CFAR, robust CFARs, adaptive CFARs.

Doppler Processing: Review of Doppler shift and pulsed radar data, Pulsed radar Doppler data acquisition and characteristics, Moving Target Indication, Pulse Doppler Processing.

Fundamentals of Pulse compression waveforms: Pulse compression waveforms, Linear Frequency Modulated Waveforms, Phase coded waveforms.

Text Books

4. Mark A.Richards, James A.Scheer, William A.Holm," Principles of Modern RADAR", Yesdee Publishing Pvt Ltd, 1st Edition, 2012.
5. Mark A.Richards, "Fundamentals of Radar Signal Processing", Tata McGraw Hill, 1st Edition, 2005.

Reference Books:

2. Steven M.Kay, "Fundamentals of Statistical Signal Processing", Vol II Detection Theory, Prentice Hall Inc, 1998.
3. Nathanson, F.E, "Radar Design Principles, second edition, McGraw-Hill, New York, 1991.

Course Contents and Lecture Schedule

No.	Topic	No. of Lectures
1	Radar:	
1.1	Radar concept, basic radar measurements,	1
1.2	Basic radar functions	1
1.3	Radar range equation: Amplitude model	1
1.4	simple point target radar range equation	1
1.5	distributed target radar range equation	1
1.6	noise model and signal to noise ratio	1
1.7	search mode fundamentals	1
1.8	overview of detection fundamentals	1
2	Characteristics of Clutter:	
2.1	General characteristics of clutter and clutter modelling	1
2.2	Clutter modelling	1
2.3	Tutorial	1
3	Threshold detection of radar targets:	
3.1	Detection strategies for multiple measurements,	1
3.2	Introduction to optimal detection: Hypothesis testing and Neyman-Pearson criterion,	1
3.3	statistical models for noise and target RCS in radar,	1
3.4	Threshold detection of radar signals.	1
3.5	Tutorial	1
4	Constant False Alarm Rate Detectors:	

4.1	Overview of detection theory	1
4.2	false alarm impact and sensitivity	2
4.3	CFAR detectors, Cell averaging CFAR	1
4.4	robust CFARs,	2
4.5	Adaptive CFARs.	2
4.6	Tutorial	1
5	Doppler Processing:	
5.1	Review of Doppler shift and pulsed radar data	1
5.2	Pulsed radar Doppler data acquisition and characteristics	2
5.3	Moving Target Indication	2
5.4	Pulse Doppler Processing	1
5.5	Tutorial	1
6	Fundamentals of Pulse compression waveforms:	
6.1	Pulse compression waveforms	1
6.2	Linear Frequency Modulated Waveforms	1
6.3	Phase coded waveforms	1
6.4	Tutorial	1
	Total	36

Course Designers:

1	Dr.V.Abhaikumar	principal@tce.edu
2	Dr.S.J.Thiruvengadam	sjtece@tce.edu
3	Dr.P.G.S.Velmurugan	pqsvs@tce.edu

14ECPJ0	BIO-MEDICAL INSTRUMENTATION	Category	L	T	P	Credit
		PE	3	0	0	3

Preamble

The proposed course is offered in the sixth semester. The course is designed to make the student acquire conceptual knowledge of the physiological systems of the human body and relate them to the parameters that have clinical importance. The relation between electronic concepts and biological concepts is highlighted. The principles of electronic instrumentation that are currently deployed in the clinical side are introduced.

Prerequisite

NIL

Course Outcomes

On the successful completion of the course, students will be able to

CO1. Explain the human physiology.	Understand
CO2. Illustrate the working of biomedical equipments.	Understand
CO3. Apply Electronic Principles for recording and Monitoring Bio Signals	Apply
CO4. Distinguish diagnostic equipments from therapeutic equipments	Analyze
CO5. Examine the internal organs through imaging	Analyze
CO6. Appraise the use of sensors and transducers for bio medical measurements	Evaluate

Mapping with Programme Outcomes

COs	PO 1	PO 2	PO 3	PO 4	PO 5	PO 6	PO 7	PO 8	PO 9	PO 10	PO 11	PO 12	PSO 1	PSO 2	PSO 3
CO1	M	-	-	-	-	-	-	-	-	-	-	L	-	-	L
CO2	M	L	-	-	-	-	-	-	-	-	-	L	L	-	L
CO3	S	M	-	-	-	L	L	L	L	L	-	L	M	-	L
CO4	S	S	S	-	-	L	L	L	L	L	-	L	M	-	L
CO5	S	S	S	-	-	L	L	L	L	L	-	L	S	L	L
CO6	S	S	S	S	-	L	L	L	L	L	-	L	S	M	L

S- Strong; M-Medium; L-Low

Assessment Pattern

Bloom's Category	Continuous Assessment Tests			Terminal Examination
	1	2	3	
Remember	0	0	0	0
Understand	40	40	40	40
Apply	20	20	20	20
Analyse	20	20	20	20
Evaluate	20	20	20	20
Create	0	0	0	0

Course Level Assessment Questions**Course Outcome 1(CO1):**

1. Explain the functional organisation of nervous system.
2. Illustrate cell and its structure.
3. Outline the cardiovascular system.
4. Explain the functioning of respiratory system.

Course Outcome 2 (CO2):

1. Outline the basic components of a bio-medical system.
2. Demonstrate the working of photo plethysmography.
3. Explain the working of Blood gas analysers.
4. Summarize the working of various medical imaging equipments.
5. Illustrate the working of Blood PH meter.

Course Outcome 3 (CO3):

1. Show how cardiac output is measured.
2. Choose a suitable method for measuring the PH of blood.
3. Identify a suitable method for assisting cardiac functioning.
4. Model a setup for medical communication.
5. Make use of the Electronic principles for developing an audio meter.

Course Outcome 4 (CO4):

1. Show how biomedical equipments are classified.
2. Contrast diagnostic equipments from therapeutic equipments.
3. List the various transducers deployed in the clinical side.
4. Examine how pulmonary function measurements are achieved.
5. Classify the usage of various electrodes for diagnostic and therapeutic purpose.

Course Outcome 5 (CO5):

1. Analyse the working of computer tomographic scanners.
2. Classify the various medical imaging techniques.
3. Compare thermography with ultrasonography
4. Distinguish MRI from CAT.
5. How the internal organs are examine through endoscopy.

Course Outcome 6 (CO6):

1. Evaluate the use of ultrasonics for medical non invasive scanning.
2. Appraise the use of fibre optics temperature sensor.
3. Appraise the principle of bio telemetry.
4. Evaluate the importance of patient monitoring.
5. Appraise the usage of electrodes for electro surgery.

Concept Map

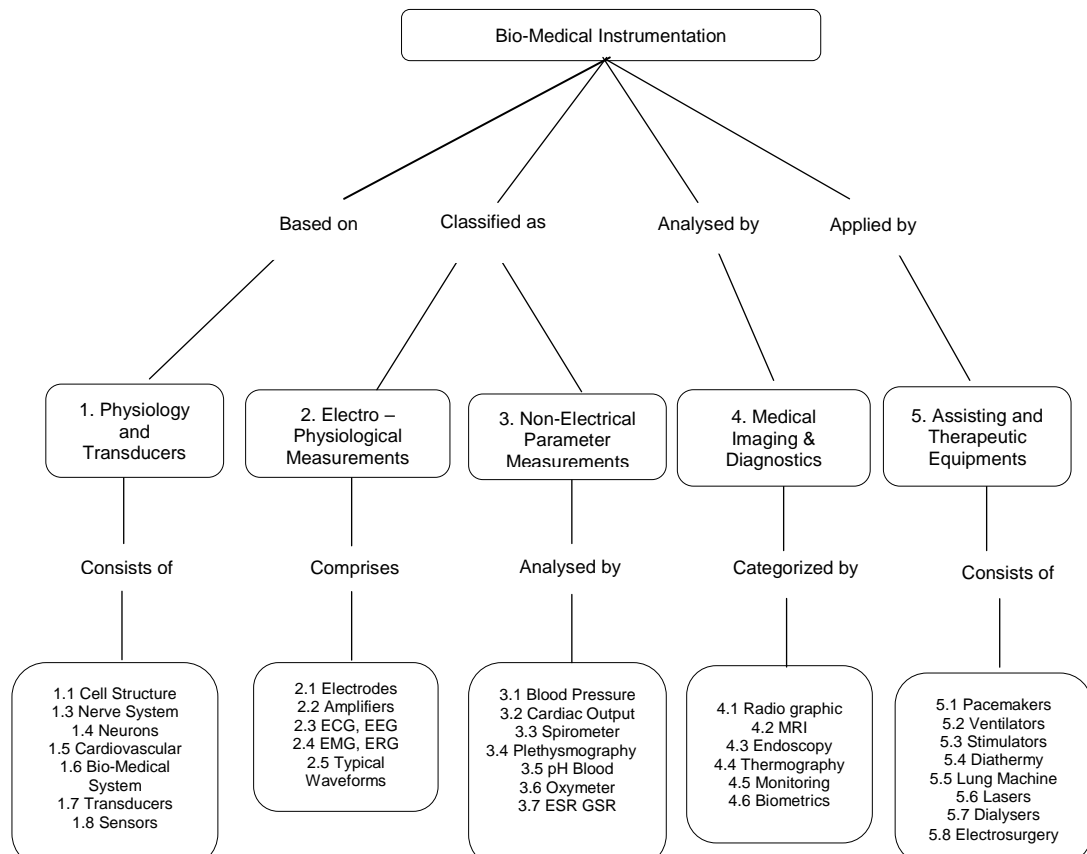

Syllabus

Physiology and Transducers: Cell and its structure, Resting and Action Potential, Nervous system: Functional organization of the nervous system, Structure of nervous system, Neurons – Synapse, Transmitters and Neural Communication, Cardiovascular system, respiratory system, Basic components of a bio-medical system, Transducers - Ultrasonic transducers, Temperature measurements - Fiber optic temperature sensors.

Electro – Physiological Measurements: Electrodes, Limb electrodes, Floating electrodes, pregelled disposable electrodes, Micro, needle and surface electrodes, Amplifiers, Preamplifiers, differential amplifiers, chopper amplifiers, Isolation amplifier, ECG, EEG, EMG, ERG, Lead systems and recording methods, Typical waveforms.

Non -Electrical Parameter Measurements: Measurement of blood pressure, Cardiac output, Heart rate, Heart sound, Pulmonary function measurements, Spirometer, Photo Plethysmography, Body Plethysmography, Blood Gas analyzers: pH of blood, Measurement of blood pCO₂, pO₂, finger-tip oxymeter, ESR, GSR measurements.

Medical Imaging and Diagnostics: Radio graphic and fluoroscopic techniques, Computer tomography, MRI, Ultrasonography, Endoscopy, Thermography, Different types of biotelemetry systems and patient monitoring, Introduction to Biometric systems.

Assisting and Therapeutic Equipments: Pacemakers, Defibrillators, Ventilators, Nerve and muscle stimulators, Diathermy, Heart –Lung machine, Lasers, Audio meters, Dialysers, Lithotripsy, Electro Surgery.

Text Books

4. R.S.Khandpur, 'Hand Book of Bio-Medical instrumentation', Tata McGraw Hill Publishing Co Ltd.,2003.
5. Leslie Cromwell, Fred J.Weibell, Erich A. Pfeiffer, 'Bio-Medical Instrumentation and Measurements', II edition, Pearson Education, 2002.

Reference Books:

6. Joseph J. Carr, John M. Brown, 'Introduction to Biomedical Equipment Technology', Fourth Edition, Pearson.
7. Shakti Chatterjee, Aubert Miller, 'Bio-Medical Instrumentation Systems', Cengage Learning, 2010.
8. C.Rajarao and S.K. Guha, 'Principles of Medical Electronics and Bio-medical Instrumentation' ,Universities press (India) Ltd, Orient Longman Ltd, 2000

Course Contents and Lecture Schedule

Module No	Topic	No.of Lectures
1	Physiology and Transducers	
1.1	Cell and its structure	1
1.2	Resting and Action Potential	1
1.3	Nervous system: Functional organisation of the nervous system, Structure of nervous system	2
1.4	Neurons – Synapse, Transmitters and Neural Communication	1
1.5	Cardiovascular system, respiratory system	1
1.6	Basic components of a bio-medical system	1
1.7	Transducers - Ultrasonic transducers	1
1.8	Temperature measurements - Fiber optic temperature sensors	1
2	Electro – Physiological Measurements	
2.1	Electrodes, Limb electrodes, Floating electrodes, pregelled disposable electrodes, Micro, needle and surface electrodes	2
2.2	Amplifiers, Preamplifiers, differential amplifiers, chopper amplifiers, Isolation amplifier	2

2.3	ECG, EEG Lead systems and recording methods	2
2.4	EMG, ERG Lead systems and recording methods	2
2.5	Typical waveforms	1
3.	Non -Electrical Parameter Measurements	
3.1	Measurement of blood pressure	2
3.2	Cardiac output, Heart rate, Heart sound	1
3.3	Pulmonary function measurements, Spirometer	1
3.4	Photo Plethysmography, Body Plethysmography	2
3.5	Blood Gas analyzers: pH of blood	2
3.6	Measurement of blood pCO ₂ , pO ₂ , Finger-tip oxymeter	2
3.7	ESR, GSR measurements	2
4	Medical Imaging and Diagnostics	
4.1	Radio graphic and fluoroscopic techniques	2
4.2	Computer tomography, MRI	2
4.3	Ultrasonography, Endoscopy	1
4.4	Thermography	1
4.5	Different types of biotelemetry systems and patient monitoring	2
4.6	Introduction to Biometric systems	1
5	Assisting and Therapeutic Equipments	
5.1	Pacemakers	1
5.2	Defibrillators, Ventilators	1
5.3	Nerve and muscle stimulators	1
5.4	Diathermy	1
5.5	Heart –Lung machine	2
5.6	Lasers, Audio meters	2
5.7	Dialysers, Lithotripsy	2
5.8	Electro Surgery	1

Course Designers:

1. Dr. (Mrs.) R. Sukanesh

sukanesh@tce.edu

14ECPK0	NETWORK SECURITY	Category	L	T	P	Credit
		PE	3	0	0	3

Preamble

The objectives of this course are to provide in-depth understanding of the underlying concepts of different classical and modern cryptographic techniques along with their network security applications like IP security, WEB security and System security.

Prerequisite

NIL

Course Outcomes

On the successful completion of the course, students will be able to

CO1. Explain conventional encryption technique, classical encryption technique and modern encryption technique.	Remember
CO2. Describe Asymmetric encryption algorithm and Diffie-Hellman algorithm	Understand
CO3. Understand network security applications like IP security, WEB security and System security along with different key management and distribution technique in symmetric and Asymmetric algorithm	Understand
CO4. Identify the threats and security attacks in the networks and corresponding services and mechanisms	Apply
CO5. Provide a practical survey of both principles and practice of cryptography and network security technology	Analyze

Mapping with Programme Outcomes

COs	PO 1	PO 2	PO 3	PO 4	PO 5	PO 6	PO 7	PO 8	PO 9	PO 10	PO 11	PO 12	PSO 1	PSO 2	PSO 3
CO1	M	L	-	-	-	-	-	L	M	L	-	-	L	-	L
CO2	S	M	M	L	L	-	-	M	-	M	-	L	S	L	L
CO3	S	M	M	L	-	-	-	L	M	L	-	-	M	-	L
CO4	S	M	M	L	-	-	-	M	L	M	-	L	S	L	L
CO5	S	S	S	M	M	-	-	-	L	L	-	L	S	L	L

S- Strong; M-Medium; L-Low

Assessment Pattern

Bloom's Category	Continuous Assessment Tests			Terminal Examination
	1	2	3	
Remember	30	0	0	0
Understand	30	30	20	30
Apply	40	40	50	40
Analyze	0	30	30	30
Evaluate	0	0	0	0
Create	0	0	0	0

Course Level Assessment Questions**Course Outcome 1(CO1):**

1. Encrypt the term "EXAM" using playfair cipher
2. List four general categories of schemes for the distribution of public keys
3. What is the purpose of Dual signature?
4. What is digital immune system

Course Outcome 2 (CO2):

1. Explain Statistical anomaly detection and rule based detection techniques
2. Discuss in detail about different types of malicious programs.
3. Distinguish MAC and Hash function in detail
4. Differentiate conventional encryption with public key encryption

Course Outcome 3 (CO3)

1. Elaborate Key management operation in IPsec
2. Explain about payment processing in SET
3. Discuss about the web security threats and the methods used to overcome the threats

Course Outcome 4 (CO4):

1. Encrypt and decrypt the term "Final Exam" using the Hill cipher with the key

$$k = \begin{bmatrix} 0 & 3 & 0 \\ 0 & 0 & 21 \\ 15 & 0 & 0 \end{bmatrix} \text{ such that } kk^{-1} = I.$$

2. Determine $11^{23} \text{ mod } 187$.
3. In an RSA system, the public key of a given user is $e=31, n=3599$. What is the Private key of this user. When $M=48$, find C and verify it.
4. Using play-fair cipher encrypt the term "buffallo" using the keyword "BALLOON"

Course Outcome 5 (CO5):

1. The plaintext 'letusmeetnow' and the corresponding 'HBCDFNOPIKLB' are given. The algorithm used is Hill cipher, but the key size is unknown. Identify the key matrix.
2. Identify the demerits of S-DES and motivation of feistel block cipher with its neat diagram.
3. When the PT-109 American patrol boat, under the command of Lieutenant John F Kennedy was sunk by a Japanese destroyer, a message was received at an Australian wireless station in play fair code.

KXJEY UREBE ZWEHE WRYTU HEYFS
 KREHE GOYFI WTTTU OLKSY CAJPO
 BOTEI ZONTX BYBNT GONEY CUZWR
 GDSON SXBOU YWRHE BAAHY USEDQ

The key used was "ROYAL NEWZEALAND NAVY". Decrypt the message.

Concept Map

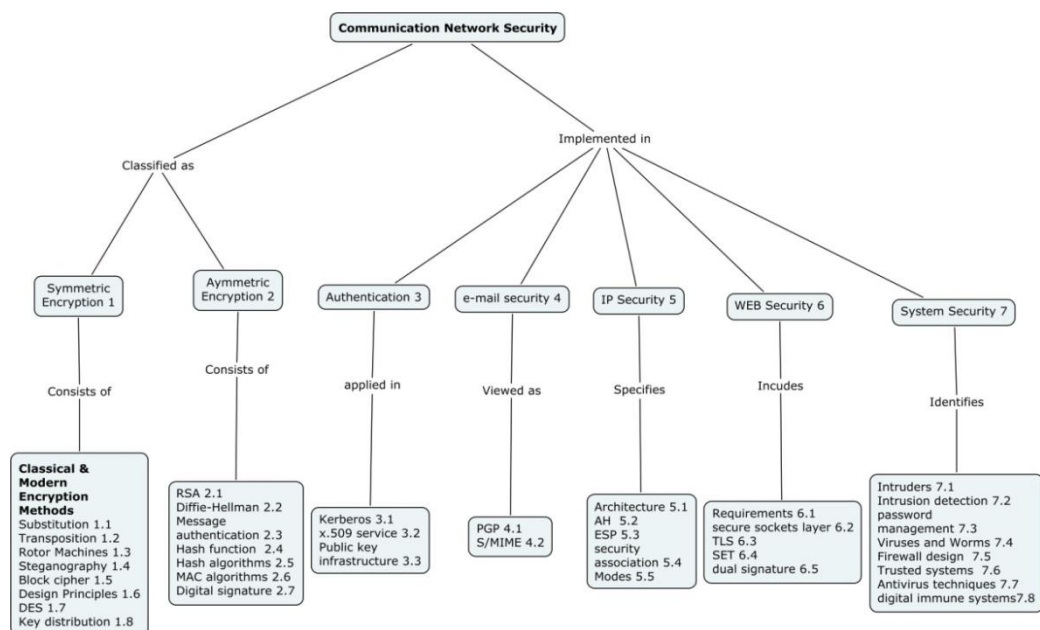

Syllabus

Conventional Encryption: Introduction – Conventional Encryption model – Data Encryption Standard – block cipher – Encryption algorithms – confidentiality – Key distribution. **Public Key Encryption and Hashing:** Principles of Public key cryptosystems – RSA algorithm – Diffie-Hellman Key Exchange – Message authentication and Hash function – Hash MAC algorithms – Digital signatures. **Authentication applications-** Kerberos, x.509 Authentication service, Public key infrastructure. **Electronic Mail Security:-** Pretty Good Privacy, S/MIME. **IP and WEB Security:** IP security overview – IP security Architecture, authentication Header – Security payload – security association – key management. Web security requirement – secure sockets layer – transport layer security –secure electronic transaction – dual signature. **System Security:** Intruders – Intrusion detection-password management -Viruses – Viruses and related threats-Worms – Firewall design – Trusted systems – Antivirus techniques – digital immune systems.

Text Book

1. William Stallings. "Cryptography and Network Security", 4th Edition, Prentice Hall of India, New Delhi, 2004.

Reference Books:

1. C. Kaufmann, R. Perlman and M. Speciner, "Network Security: Private Communication in a Public World", Prentice Hall PTR, 2002.
2. W.R. Cheswick, S.M. Bellovin and A.D. Rubin, "Firewalls and Internet Security", Addison- Wesley, 2003.

Course Contents and Lecture Schedule

Module. No.	Topics	No of Lectures
1	Conventional Encryption	
1.1	Introduction – Conventional Encryption model	2
1.2	Data Encryption Standard – block cipher	2
1.3	Different Encryption algorithms	2
1.4	Confidentiality	2
1.5	Key distribution	1
2	Public Key Encryption and Hashing:	
2.1	Principles of Public key cryptosystems – RSA algorithm	2
2.2	Diffie-Hellman Key Exchange	2
2.3	Message authentication and Hash function	2
2.4	Hash MAC algorithms	2
2.5	Digital signatures.	2
3	Network security applications	
3.1	Pretty Good Privacy,	2
3.2	S/MIME	2
4.1	IP and WEB Security-introduction	2
4.2	IP security overview – IP security Architecture	1
4.3	Authentication Header – Security Payload	1
4.4	Security association –key management.	1
4.5	Web security requirement	1
4.6	Secure sockets layer – transport layer security	1
4.7	Secure electronic transaction – dual signature	1
5	System Security	
5.1	Intruders – Intrusion detection-	1

Module. No.	Topics	No of Lectures
5.2	Password management	1
5.3	Viruses – Viruses and Related threats-Worms	1
5.4	Firewall design – Trusted systems	1
5.5	Antivirus techniques – digital immune Systems.	1
	Total Number of Hours	36

Course Designer:

1	Dr.M.S.K.Manikandan	manimsk@tce.edu
---	---------------------	-----------------



14ECPL0	SOFTWARE DEFINED AND COGNITIVE RADIO NETWORKS	Category	L	T	P	Credit
		PE	3	0	0	3

Preamble

This course presents the state-of-the-art in the field of Software defined and Cognitive Radio Systems. The course will enable the students to learn about the architecture, design methodologies, spectrum sensing and management techniques used in emerging wireless applications.

Prerequisite

14EC510 Data Communication Networks

Course Outcomes

On the successful completion of the course, students will be able to

CO1	To expose the evolving next generation wireless networks and their associated challenges, describe the various requirements and functionalities of software / cognitive radio.	Understand
CO2	Design the architecture of Software Defined Cognitive Radio Systems.	Apply
CO3	Apply and implement the Cognitive Radio design methodologies in the wireless applications.	Apply
CO4	To design and analyze the impact of the evolved solutions in Cognitive Radio based future wireless network design.	Analyze
CO5	To assess the performance of the spectrum sensing techniques in practical applications.	Analyze

Mapping with Programme Outcomes

COs	PO 1	PO 2	PO 3	PO 4	PO 5	PO 6	PO 7	PO 8	PO 9	PO 10	PO 11	PO 12	PSO 1	PSO 2	PSO 3
CO1	S	M	M	L	L	-	-	M	M	M	-	L	M	M	L
CO2	S	M	M	-	L	-	-	M	M	M	M	L	S	M	M
CO3	S	M	M	L	M	-	-	M	S	S	M	M	S	M	M
CO4	S	S	M	M	M	-	-	M	S	S	M	M	S	S	M
CO5	M	S	M	L	S	-	-	M	S	S	M	M	M	S	M

Assessment Pattern

Continuous Assessment Tests				End Semester Examinations
Bloom's Category	1	2	3	
Remember	20	20	20	0
Understand	40	40	20	20
Apply	40	40	40	40
Analyze	0	10	20	40
Evaluate	0	0	0	0
Create	0	0	0	0

Course Level Assessment Questions

Course Outcome 1 (CO1):

1. How CR is equipped with more reconfigurable features than SDR?
2. Define the term quick logic used in SDR design
3. Enlist the design tools available for SDR
4. In what way software reconfiguration relates to SDR?
5. Give the requirements of cognitive radio
6. list out the spectrum access problems in cognitive radio
7. Draw the system model of cognitive radio transmitter.
8. List the specifications & requirements needed for a candidate architecture SDR
9. Draw the timing diagram of cognitive cycle
10. Define the term spectrum pooling.
11. Compare convex and non-convex optimization methods.
12. What are the applications of bargaining games?

Course Outcome (CO2):

1. Illustrate the features of Software tunable smart antenna in cognitive systems?
2. Determine the spectrum capacity of an unlicensed user when it receives a signal power of 40 dB while sensing 20 MHz wide bandwidth in a Gaussian channel with a noise power of 5dB.
3. Compare the benefits of tit-for tat gaming model with Nash equilibrium model for spectrum pricing strategy.
4. Summarize cross layer design issues for next generation CR networks.

Course Outcome (CO3):

1. Identify the methodologies to implement reconfigurable wireless communication system over a single platform in SDR?
2. State the role of Software tunable smart antennas in cognitive systems.
3. In cognitive radio network calculate the outage probability and interference if the base station transmits signal power at 20 dB along with noise power 5 dB at 800 MHz. Assume the user is at a distance of 20 km. Assume maximum propagation distance $r_{max}=40$.
4. Design a typical Digital front end for SDR transmitter.
5. Determine the improvement in spectrum utilization of spectrum agile secondary network where there are 5 primary users available and its ON time is quarter the OFF time.

Course Outcome (CO4):

1. Give the goal of spectrum adaptation. Explain any one spectrum adaptation technique.
2. Assess the better solution offered by UWB cognitive radio.
3. Explain how Cramer Rao bound estimates bounding criteria for any unbiased estimator?
4. Analyze how Markov model can be utilized for decision making process in cognitive radio networks.

Course Outcome (CO5):

1. Write a technical note on cognitive radio based location estimation.
2. Analyze active probing method for aggressive spectrum sensing in CR.
3. Assess the performance of an OFDM based CR in health monitoring applications.
4. Illustrate the benefits of intelligent algorithms in learning and adapting wireless transmission according to the ambient radio environment.

Concept Map

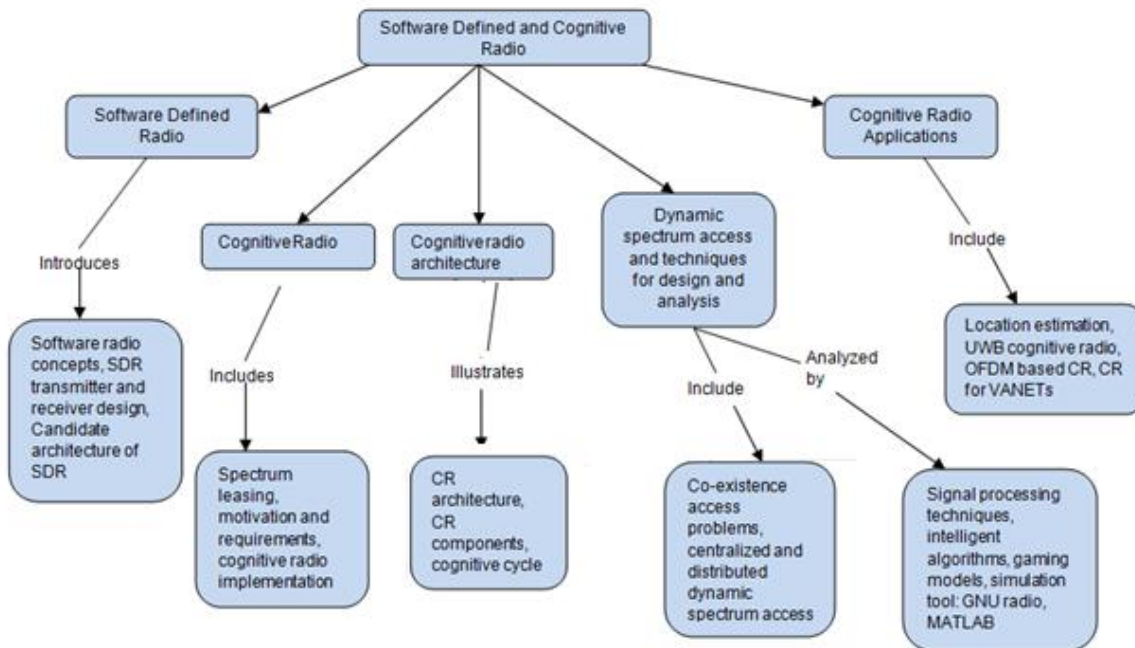

Syllabus

Software Defined Radio: Evolution- architecture perspectives- Software radio concepts- SDR front end technology: Transmitter specifications- Receiver specifications- operating frequency bands- receiver design considerations- transmitter design considerations- Candidate architecture for SDR- Overview of Multimode SDR architecture. **Cognitive radio:** Introduction to cognitive radios –economics of cognitive radio-spectrum awareness, spectrum subleasing, spectrum sharing- cognitive networks:- motivation & requirements- foundation & related works in cognitive radio- cognitive radio implementation. **Cognitive radio architecture:** SDR technology underlies cognitive radio- CR architecture- CR components- CR design rules- cognitive cycle- SDR and Cognitive radio relationship - building cognitive radio on SDR architecture- research challenges in CR- Standards - **Dynamic spectrum Access:** Coexistence & access problems in Cognitive radios- centralized and distributed dynamic spectrum access- spectrum sensing methods for Cognitive radios- spectrum sensing in current wireless standards: IEEE 802.11 AD, SCC41, 802.22 standards- a case study. **Design and analysis of dynamic spectrum access and Management:** Signal processing techniques, optimization techniques, basics of game theory, intelligent algorithms, cross layer optimization, simulation tools: GNU radio and NS2. **Cognitive Radio Applications:- Cognitive radios** in wireless communication, Mobility management, location estimation & sensing, UWB Cognitive radio, OFDM based CR, CR for VANETs.

Text Books

1. Walter Tuttlebee, "Software defined Radio Enabling Technologies", John Wiley & Sons, Ltd, 2002, ISBN: 0-470-84318-7.
2. Huseyin Arslan, "Cognitive Radio, Software Defined Radio and Adaptive Wireless Systems", Springer, 2007, ISBN: 978-1-4020-5541-6.
3. Ekram Hossain, Dusit Niyato, Zhu Han, "Dynamic Spectrum Access and Management in Cognitive Radio Networks", Cambridge University Press, 2009, ISBN: 978-0-521-89847-8.

Reference Books

1. Kamal Deep Singh, Priyanka Rawat, Jean Marie Bonnin, "Cognitive radio for vehicular adhoc networks: approaches and challenges", EURASIP Journal on Wireless Communications and networking, 2014.
2. GNU radio implementation, courses.washington.edu/ee420/projects/lab2_gnuradio.pdf.
3. Kwang-Cheng Chen, Ramjee Prasad, "Cognitive Radio Networks", John Wiley & Sons Ltd., 2009.
4. Bruce Fette, "Cognitive Radio Technology - Second Edition", Elsevier, 2009.

Course Contents and Lecture Schedule

Module No.	Topics	No. of Lectures
1.	Software Defined Radio	
1.1	Evolution	1
1.2	Architecture perspectives	1
1.3	Software radio concepts	1
1.4	SDR front end technology: Transmitter specifications and Receiver specifications	1
1.5	Operating frequency bands	
1.6	Receiver design considerations & transmitter design considerations	1
1.7	Candidate architecture for SDR	1
1.8	Overview of Multimode SDR architecture	1
2	Cognitive radio	
2.1	Introduction to cognitive radios	1
2.2	Economics of cognitive radio	1
2.3	Spectrum awareness, spectrum subleasing, spectrum sharing	1
2.4	Cognitive networks- motivation & requirements	1
2.5	Foundation & related works in cognitive radio	1
2.6	Cognitive radio implementation	1
3	Cognitive radio architecture	
3.1	SDR technology underlies cognitive radio	1
3.2	CR architecture, CR components, CR design rules	1
3.3	Cognitive cycle	1
3.4	SDR and Cognitive radio relationship	1
3.5	Building cognitive radio on SDR architecture	1
3.6	Research challenges in CR, Standards	1
4	Dynamic spectrum Access	
4.1	Coexistence & access problems in Cognitive radios	1
4.2	Centralized and distributed dynamic spectrum access	1
4.3	Spectrum sensing methods for Cognitive radios	1
4.4	Spectrum sensing in current wireless standards: IEEE 802.11 AD, SCC41, 802.22 standards a case study.	1
5	Design and analysis of dynamic spectrum access and Management	

5.1	Signal processing techniques	1
5.2	Optimization techniques	1
5.3	Basics of game theory	1
5.4	Intelligent algorithms	1
5.5	Cross layer optimization	1
5.6	Simulation tools: GNU radio and NS2	1
6	Cognitive Radio Applications	
6.1	Cognitive radios in wireless communication	1
6.2	Mobility management	2
6.3	location estimation & sensing	1
6.4	UWB Cognitive radio	1
6.5	OFDM based CR	1
6.6	CR for VANETs	1
Total		36

Course Designers

Dr. (Mrs.) M. Suganthi

suganthi@tce.edu



14ECPM0	LOW POWER VLSI SYSTEMS	Category	L	T	P	Credit
		PE	3	0	0	3

Preamble

Increased levels of integration (increased functionality) and higher throughput under tight power budgets has led to the need for changes in the traditional way of designing circuits and systems. Portable communication and computation have driven the need for low-power electronics. Recent progress has been made in creating tools for estimating power dissipation in CMOS circuits. The research approach is to use accurate and efficient power estimation techniques to drive the design of new low-power systems. Software tools for testing integrated circuits, rapid fault simulation, and failure analysis are also being developed. This course discusses design techniques, estimation and optimisation of power at various levels of design abstraction for designing energy-efficient digital systems used in Battery operated devices.

Prerequisite

14EC520 : Digital CMOS Systems

Course Outcomes

On the successful completion of the course, students will be able to

CO1	Understand the power dissipation in CMOS VLSI circuits.	Understand
CO2	Optimize power by designing low-power CMOS VLSI arithmetic circuits including adders and multipliers.	Apply
CO3	Design low-power CMOS VLSI circuits including memories, clock-interconnect and layout design using various techniques.	Apply
CO4	Determine logic level power requirement and analyze power using simulation and probability.	Analyse
CO5	Synthesize and design software for low-power CMOS VLSI Circuits.	Evaluate

Mapping with Programme Outcomes

COs	PO 1	PO 2	PO 3	PO 4	PO 5	PO 6	PO 7	PO 8	PO 9	PO 10	PO 11	PO 12	PSO 1	PSO 2	PSO 3
CO1	M	-	-	-	-	-	-	-	-	-	-	-	L	-	-
CO2	S	M	M	L	L	-	-	-	-	-	-	-	M	L	-
CO3	S	M	L	L	-	-	-	-	M	L	-	-	M	L	-
CO4	S	S	L	M	M	-	-	-	-	-	-	-	M	L	-
CO5	S	S	S	M	M	-	-	-	M	M	-	-	S	M	-

S- Strong; M-Medium; L-Low

Assessment Pattern

Bloom's category	Continuous Assessment Tests			End Semester Examinations
	1	2	3	
Remember	20	20	0	0
Understand	30	30	20	20
Apply	50	50	40	40
Analyze	0	0	20	20
Evaluate	0	0	20	20
Create	0	0	0	0

Course Level Assessment Questions**Course Outcome 1 (CO1):**

1. Why is the noise immunity of CMOS dynamic logic circuits worse as compared to the static logic circuit? Is there any method to raise the noise immunity? At what cost?
2. What are the advantages of multiple output domino logic (MODL)? What are the possible problems? How can they be avoided?
3. What factors affect the initial voltage difference in the DRAM bit lines during the read cycle?
4. What factors affect the initial voltage difference in the DRAM bit lines during the read cycle?
5. When the supply voltage is lowered, what is the influence in the initial voltage difference in the bit lines during the read cycle?

Course Outcome 2 (CO2):

1. Calculate the threshold voltage of an NMOS device with an N^+ polysilicon gate, a channel length of $0.25\mu\text{m}$, a gate oxide of 55\AA , a junction depth of $0.15\mu\text{m}$, and a doping density of 10^{18}cm^{-3}
2. Determine V_{OH} , V_{OL} , V_{IH} , V_{IL} for the NMOS inverter with a depletion load with its gate connected to source. Suppose $k_i = 25\mu\text{A}/\text{V}^2$ for the driver NMOS device. $k_1 = 6.25\mu\text{A}/\text{V}^2$ for the depletion load NMOS device. The threshold voltage of the depletion load NMOS device is -3V and 0.8V for the enhancement-mode device. $V_{DD} = 5\text{V}$.
3. Compute the output switching activity α_{O1} , α_{O2} and α_F of the chain-type 4-input AND gate. Consider the cases with $P(A = 1) = P(B = 1) = P(C = 1) = P(D = 1) = 0.75$ and 0.25 respectively. Analyze its switching activity.

Course Outcome 3(CO3):

1. Construct a logic function $F = AB + BC + CA$ using 2-input NAND and NOR gates. If an n-well CMOS technology is used, which approach should be used to reduce the body effect on degrading the circuit performance? If p-well CMOS technology is used, which approach should be used?
2. Use the pass-transistor logic circuits to construct the logic function $F = AB + \overline{BC} + \overline{A} \cdot \overline{B}$
3. Construct a logic function $F = AB + AC + \overline{A}\overline{D}\overline{E} + BE$ using CPL and DPTL and LEAP. Use binary decision diagram (BDD) to design the above logic function.

Course Outcome 4 (CO4):

1. Using and domino dynamic logic circuits, design a logic function $F = A \oplus B \oplus C$ in one stage and two cascading stages. Analyse and discuss the transient performance of the circuit for load capacitances of 0.01pF , 0.1pF , and 0.5pF , and at supply voltages of 5V , 3.3V , 2.5V , and 1.5V .
2. Consider domino dynamic logic circuits for the logic function $F = A \cdot B \cdot C$. Analyse and discuss the transient performance of the circuit for load capacitances of 0.1pF , and 0.5pF , and at supply voltages of 5V , 3.3V and 2V .
3. Consider the 6-input AND gate. $W(MN3) = 5\mu\text{m}$. $W(MNi) = W(MN3) (1 - \alpha(i - 3))$, $i = 0 - 6$. Compare the differences in the propagation delay for $\alpha = -0.05, 0, 0.05, 0.1, 0.2$.
4. Consider the 6-input AND gate. $W(MN3) = 4\mu\text{m}$. $W(MNi) = W(MN3) (1 - \alpha(i - 3))$, $i = 0 - 6$. Compare the differences in influence of the worst-case charge-sharing problem for $\alpha = -0.05, 0, 0.05, 0.1, 0.2$.

Course Outcome 5 (CO5):

1. Use static CMOS logic circuits and complementary pass-transistor logic (CPL) to design the parallel adder. Which approach has the best speed performance (smallest propagation delay)? For the design with the best speed performance, is its throughput also the highest?
2. Compare the performance of the multipliers using Wallace tree reduction with 3-to-2 and 4-to-2 compressor, modified Booth encoder/decoder, and combining modified Booth encoder/decoder with Wallace tree reduction.

Concept Map

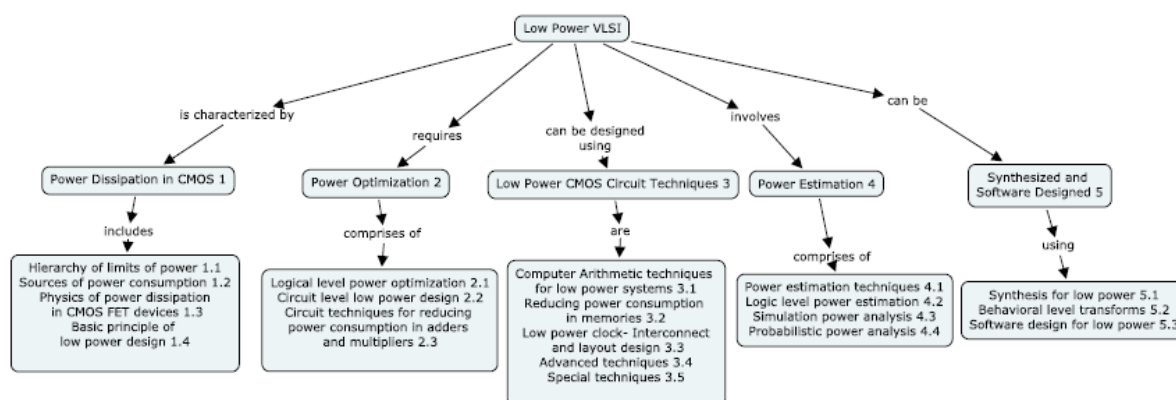

Syllabus

Power Dissipation in CMOS: Hierarchy of limits of power, Sources of power consumption, Physics of power dissipation in CMOS FET devices, Basic principle of low power design. **Power Optimization:** Logical level power optimization, Circuit level low power design, Circuit techniques for reducing power consumption in adders and multipliers. **Low Power CMOS Circuits:** Computer Arithmetic techniques for low power systems, Reducing power consumption in memories, Low power clock- Interconnect and layout design, Advanced techniques, Special techniques. **Power Estimation:** Power estimation techniques, Logic level power estimation, Simulation power analysis, Probabilistic power analysis. **Synthesis and Software Design for Low Power:** Synthesis for low power, Behavioural level transforms, Software design for low power.

Text Books:

1. K. Roy and S.C. Prasad, "Low Power CMOS VLSI Circuit Design", Wiley, 2000.
2. Gary Yeap, "Practical Low Power Digital VLSI Design", Kluwer, 1998.

Reference Books:

9. A.P. Chandrakasan and R.W. Brodersen, "Low Power Digital CMOS Design", Kluwer, 1995.
10. Abdellatif Bellaouar, Mohamed. I. Elmasry, "Low Power Digital VLSI designs" Kluwer, 1995.
11. Dimitrios Soudris, Chirstian Pignet, Costas Goutis, "Designing CMOS Circuits for Low Power", Kluwer, 2002.
12. J.B. Kuo and J.H Lou, "Low voltage CMOS VLSI Circuits", Wiley, 1999.
13. A. Wang, B. H. Calhoun and A. P. Chandrakasan, "Sub-threshold Design for Ultra Low-Power Systems", Springer, 2006.

Course Contents and Lecture Schedule

Module No.	Topic	No. of Lectures
1	Power Dissipation in CMOS	
1.1	Hierarchy of limits of power	1
1.2	Sources of power consumption	2
1.3	Physics of power dissipation in CMOS FET devices	2
1.4	Basic principle of low power design	1
2	Power Optimization	
2.1	Logical level power optimization	2
2.2	Circuit level low power design	2

2.3	Circuit techniques for reducing power consumption in adders and multipliers	2
3.	Design of Low Power CMOS Circuits	
3.1	Computer Arithmetic techniques for low power systems	2
3.2	Reducing power consumption in memories	2
3.3	Low power clock- Interconnect and layout design	2
3.4	Advanced techniques	2
3.5	Special techniques	2
4	Power Estimation	
4.1	Power estimation techniques	2
4.2	Logic level power estimation	2
4.3	Simulation power analysis	2
4.4	Probabilistic power analysis	2
5	Synthesis and Software Design for Low Power	
5.1	Synthesis for low power	2
5.2	Behavioural level transforms	2
5.3	Software design for low power	2
	Total Number of Hours	36

Course Designers:

1.	Dr. V. Vinoth Thyagarajan	vkcece@tce.edu
2.	Dr. V.R. Venkatasubramani	venthiru@tce.edu

14ECPN0	VLSI DEVICE MODELING	Category	L	T	P	Credit
		PE	3	0	0	3

Preamble

The present and future generation VLSI systems are all expected to be built using MOSFETs. Over the years, the VLSI industry has systematically adapted to the use of only MOSFET for all purposes. This course introduces the principles of device modeling where in device physics and experimentally observed device performances characteristics combined so as to lead to predictable equations and expressions for device performance under scenarios of excitation.

Prerequisite

14EC520 Digital CMOS System

Course Outcomes

On the successful completion of the course, students will be able to

CO1: Explain in details about the different modeling of MOS transistor	Understand
CO2: Classify the long channel and short channel MOSFET devices	Analyze
CO3: Examine the different types of MOSFET Scaling	Analyze
CO4: Illustrate the quantum phenomena in MOS Transistors	Apply
CO5: Differentiate the various Non classical MOSFET structures	Analyze

Mapping with Programme Outcomes

S- COs	P O 1	P O 2	P O 3	P O 4	P O 5	P O 6	P O 7	P O 8	P O 9	P O 10	P O 11	P O 12	PS O 1	PS O 2	PS O 3
CO1	S	S	M	L	-	-	-	-	M	M	M	M	S	S	M
CO2	S	S	M	L	-	-	-	-	M	M	M	M	S	S	M
CO3	S	S	M	L	-	-	-	-	M	M	M	M	S	S	M
CO4	S	S	M	L	-	-	-	-	M	M	M	M	S	S	M
CO5	S	S	M	L	-	-	-	-	M	M	M	M	S	S	M

T- Strong; M-Medium; L-Low

Assessment Pattern

Bloom's Category	Continuous Assessment Tests			Terminal Examination
	1	2	3	
Remember	20	10	0	0
Understand	20	10	10	10
Apply	30	30	30	30
Analyze	30	50	60	60
Evaluate	0	0	0	0
Create	0	0	0	0

Course Level Assessment Questions

Course Outcome 1 (CO1):

- 1 Define Quasi and Non-Quasi static model.
- 2 Explain in detail about the different modeling of MOS transistor.
- 3 Describe the operation of MOSFETS.

Course Outcome 2 (CO2):

1. Classify the short channel effects in MOSFET scaling.
2. Examine the saturation current for given V_{gs} vs. Length.
3. Differentiate the techniques to reduce short channel effects of MOS Devices.

Course Outcome 3 (CO3):

1. Describe in detail about MOSFET channel length.
2. An n-channel MOSFET with n+ polysilicon gate has a substrate doping concentration of $5 \times 10^{15} \text{ cm}^{-3}$ and a gate oxide thickness of 20nm. A boron implantation is carried out in the channel region for threshold tailoring which can be approximated by a box of width $0.2 \mu\text{m}$ and a surface concentration of $5 \times 10^{16} \text{ cm}^{-3}$. Neglecting the effect of Q_f , find the values of V_{th} at (a) $V_{bs}=0\text{V}$ and (b) $V_{bs}=-5\text{V}$.
3. Examine the discrete dopant effect on threshold voltage of MOSFET.

Course Outcome 4 (CO4):

1. List the steps involved in the Carrier Energy Quantization of MOS Capacitor.
2. Build the compact Gate Current models of MOSFET
3. Analyze the gate Current density in MOS transistor.

Course Outcome 5 (CO5):

1. Illustrate the operation of Multigate MOSFETs.
2. Calculate the electro static potential of given structure with the suitable boundary conditions.

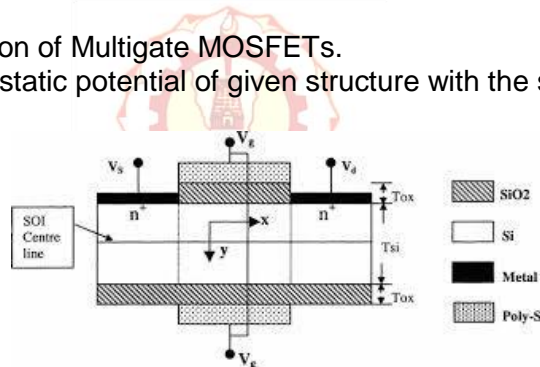

3. Examine the electrostatics DG- MOS system with the suitable equations.
 - a. Gate Voltage effect.
 - b. Semiconductor thickness effect.
 - c. Asymmetry effect.
 - d. Oxide thickness effect.
 - e. Electron tunnel current.

Concept Map

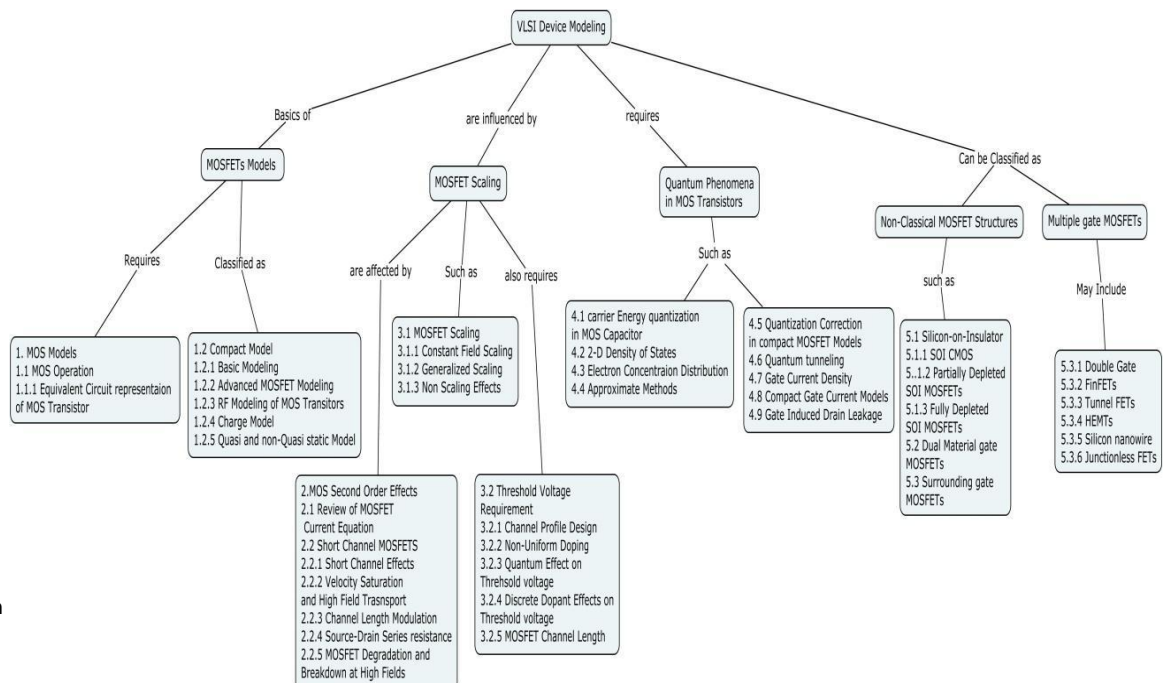

Syllabus

MOSFET MODELS : Equivalent circuit representation of MOS Transistor-Types of Compact Model - Basic modeling - Advanced MOSFET modeling - RF modeling of MOS transistors-charge model-Quasi and non-Quasi static model.

MOS SECOND ORDER EFFECTS : Review of MOSFET Current Equation - MOSFET Channel Mobility – MOSFET capacitances and Inversion-Layer Capacitance effect – Short Channel MOSFETs – Short-Channel Effect – Velocity saturation and High-Field Transport – Channel Length Modulation – Source-Drain series resistance – MOSFET Degradation and Breakdown at High Fields.

MOSFET SCALING : Constant-Field scaling – Generalized Scaling – Non scaling Effects – Threshold-Voltage Requirement – Channel Profile Design – Non-uniform Doping – Quantum Effect on Threshold Voltage – Discrete Dopant Effects on Threshold Voltage – MOSFET Channel Length.

QUANTUM PHENOMENA IN MOS TRANSISTORS : Carrier Energy Quantization in MOS capacitor – 2-D Density of States – Electron Concentration Distribution – Approximate Methods – Quantization Correction in Compact MOSFET Models – Quantum Tunneling – Gate Current Density – Compact Gate Current Models – Gate Induced Drain Leakage (GIDL)

NON – CLASSICAL MOSFET STRUCTURES : Silicon-On-Insulator Devices – SOI CMOS – Partially Depleted SOI MOSFETs – Fully Depleted SOI MOSFETs – Dual Material Gate MOSFETs – Surrounding Gate MOSFETs - Multigate MOSFETs – FINFETs-TFETs – HEMTs – Silicon Nanowires – Junction less FETs.

ReferenceBooks

1. Y. Taur and T. H. Ning, "Fundamentals of Modern VLSI Devices", Cambridge University Press, Cambridge, UnitedKingdom.
2. A.B.Bhattacharyya , " Compact MOSFET Models for VLSI Design", John Wiley & Sons Ltd.
3. Trond Ytterdal, Yuhua Cheng and Tor A. Fjeldly Wayne Wolf, "Device Modeling for Analog and RF CMOS Circuit Design", John Wiley & SonsLtd.
4. Snowden C. M., Introduction to Semiconductor Device Modeling, World Scientific Press, Singapore, 1986
5. J.P.Colinge "FinFETs and other MultigateTransistors", .

Course Contents and LectureSchedule

No.	Topic	No. of Lectures
1	MOS MODELS	
1.1	MOS operation	1
1.1.1	Equivalent circuit representation of MOS Transistor	1
1.2	Types of Compact Model	1
1.2.1	Basic modeling	1
1.2.2	Advanced MOSFET modeling	1
1.2.3	RF modeling of MOS transistors	2
1.2.4	Charge model	1
1.2.5	Quasi and non-Quasi static model	1
2	MOS SECOND ORDER EFFECT	
2.1	Review of MOSFET Current Equation	3
2.2	Short Channel MOSFETs	1
2.2.1	Short-Channel Effect	1
2.2.2	Velocity saturation and High-Field Transport	1
2.2.3	Channel Length Modulation	1
2.2.4	Source-Drain series resistance	1

2.2.5	MOSFET Degradation and Breakdown at High Fields	1
3	MOSFET SCALING	
3.1	MOSFET Scaling	
3.1.1	Constant-Field scaling	1
3.1.2	Generalized Scaling	1
3.1.3	Non scaling Effects	2
3.2	Threshold-Voltage Requirement	
3.2.1	Channel Profile Design	1
3.2.2	Non-uniform Doping	1
3.2.3	Quantum Effect on Threshold Voltage	2
3.2.4	Discrete Dopant Effects on Threshold Voltage	1
3.2.5	MOSFET Channel Length	1
4	QUANTUM PHENOMENA IN MOS TRANSISTORS	
4.1	Carrier Energy Quantization in MOS capacitor	1
4.2	2-D Density of States	1
4.3	Electron Concentration Distribution	2
4.4	Approximate Methods	1
4.5	Quantization Correction in Compact MOSFET Models	1
4.6	Quantum Tunneling	1
4.7	Gate Current Density	1
4.8	Compact Gate Current Models	1
4.9	Gate Induced Drain Leakage (GIDL)	1
5	NON – CLASSICAL MOSFET STRUCTURES	
5.1	Silicon-On-Insulator Devices	
5.1.1	SOI CMOS	1
5.1.2	Partially Depleted SOI MOSFETs	1
5.1.3	Fully Depleted SOI MOSFETs	1
5.2	Dual Material Gate MOSFETs	1
5.3	Surrounding Gate MOSFETs	1
5.3	Multiple-gate MOSFETs	1
5.3.1	Double Gate	1
5.3.2	FINFETs	1
5.3.3	TFETs	1
5.3.4	HEMTs	1
5.3.5	Silicon Nanowires	1
5.3.6	Junction less FETs	1
	Total hours	48

Course Designers:

1. Dr.N.B.Balamurugan	nbbalamurugan@tce.edu
2. Dr.S.Rajaram	rajaram_siva@tce.edu

14ECPPO	DIGITAL VIDEO PROCESSING	Category	L	T	P	Credit
		PE	3	0	0	3

Preamble

The purpose of this course is to provide an understanding of the theory behind various video processing tasks as well as practical experience in accomplishing them. The course will extend the concepts from still images (spatial) to dynamic imagery (spatio-temporal). At the lowest level, this course introduces the terminology of video processing, analog vs digital, how digital image sequences are captured, dynamic imagery perception, how the video is stored, video file formats; spatio-temporal concepts and video sampling theorem. In the mid level, it addresses a substantial part of dynamic imagery such as motion analysis in image sequences, and in particular to motion detection and motion estimation. At highest level, video enhancement, segmentation and compression algorithms will be addressed. This will be followed by real world video processing applications such video surveillance, video conferencing, video summarization and video watermarking.

Prerequisite

14EC570 Image Processing

Course Outcomes

On the successful completion of the course, students will be able to

CO1.	Demonstrate the difference between analog and digital video, usage of digital videos, how digital videos are acquired, stored, different video file formats and spatio-temporal imagery.	Understand
CO2.	Perform techniques for motion analysis such as motion detection, estimation and compensation.	Apply
CO3.	Apply video processing techniques such as enhancement, segmentation for dynamic imagery in order to perform higher level analysis.	Apply
CO4.	Learn fundamentals of video compression techniques and their applications	Apply
CO5.	Identify as well as apply these techniques to solve real-world video applications and propose solutions for the same.	Analyse

Mapping with Programme Outcomes

COs	PO 1	PO 2	PO 3	PO 4	PO 5	PO 6	PO 7	PO 8	PO 9	PO 10	PO 11	PO 12	PSO 1	PSO 2	PSO 3
CO1	M	L	-	-	L	-	-	L	L	-	-	L	L	-	L
CO2	S	M	L	L	L	L	-	-	L	L	-	-	M	M	-
CO3	S	M	L	L	L	L	-	-	L	L	-	-	M	M	L
CO4	M	L	-	-	-	-	-	L	-	-	-	-	L	L	-
CO5	S	M	M	L	M	M	-	L	M	L	-	-	M	S	L

S- Strong; M-Medium; L-Low

Assessment Pattern

Bloom's Category	Continuous Assessment Tests			Terminal Examination
	1	2	3	
Remember	10	10	0	0
Understand	30	30	20	20
Apply	60	60	60	60
Analyse	0	0	20	20
Evaluate	0	0	0	0
Create	0	0	0	0

Course Level Assessment Questions

Course Outcome 1 (CO1):

1. Define Composite, component and S-video.
2. Distinguish progressive scanning and interlaced scanning.
3. Compare CCD versus CMOS sensors.
4. Obtain the file size for 3 minutes VGA video with 25frames/second, 8 bit sound resolution and two stereo audio.
5. The figure below show two interlaced video frames.
 - a. Generate the field data associated with each frame.
 - b. Deinterlace field 1 of frame 2 using field averaging. Write down the deinterlaced field.
 - c. Now try line averaging. Write down the deinterlaced field.
 - d. Now try field and line averaging. Write down the deinterlaced field.
 - e. For this simple example, which method is better?
 - f. In general, what are the pros and cons of different methods?

100	100	200	100	100	100
100	200	200	100	100	200
100	100	200	100	100	100
100	200	200	100	100	200
100	100	200	100	100	100
Frame 1			Frame 2		

Course Outcome 2 (CO2):

1. For the following frames, obtain the motion vector for the motion compensated prediction. Obtain the motion vector for the following four objects. Consider First 8X8 as Frame I and second 8X8 as Frame II.

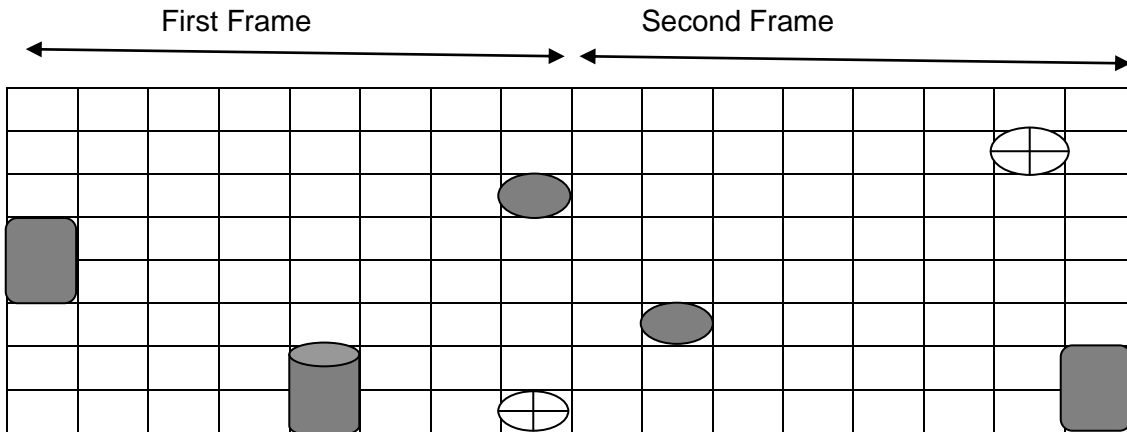

2. Illustrate with an example that background subtraction is better than frame differencing for foreground segmentation.
3. Describe spatial and temporal motion models for motion estimation.
4. Perform motion compensation of video sequences using mean-squared-error and mean-absolute-error block matching criteria, and full or fast search techniques.
5. Discuss the pros and cons of motion detection algorithm to detect moving vehicles from single static camera using fixed as well as adaptive thresholding.

Course Outcome 3 (CO3):

1. List various video artifacts and illustrate spatio-temporal noise filtering to remove one such artifact with neat sketch.
2. Illustrate how order statistics filters are used for handling data in which outliers are likely to occur to remove noise in video.
3. Demonstrate blotch detection and removal algorithm which helps to remove it from film.
4. Describe shot detection in video using scene change detection.
5. Illustrate contour based tracking for counting moving cars in a parking lot.

Course Outcome 4 (CO4):

1. Distinguish the difference between image coding and video coding. Why is it not efficient to simply apply an image coder (say JPEG) to individual video frames?
2. Describe MPEG 2 compression profiles, levels and motion compensated based prediction modes.
3. In an MPEG 2 coder, let there be two B frames between each non B frame, and let the GOP size be 15. At the source we denote the frames in one GOP as follows:

$I_1 B_2 B_3 B_4 B_5 B_6 P_7 B_8 B_9 P_{10} B_{11} B_{12} P_{13} B_{14} B_{15}$
 1 2 3 4 5 6 7 8 9 10 11 12 13 14 15

Write the order in which the frames must be coded.
 Write the order in which the frames must be decoded.

State the required display order.

4. MPEG-4 video coding standard uses the so-called “object-based coding”. Describe what it is and how a receiving user may make use of it.
5. Obtain inverse transform for the 4 x 4 DCT image matrix used in H.264I/AVC.

Course Outcome 5 (CO5):

1. Develop an algorithm to separate the unusual video shots, for example, when a car is breaking the traffic rule which is acquired by a single static camera.
2. Develop an application for video watermarking based authentication with flow diagram.
3. Illustrate in cricket sport game how the highlights are retrieved. Illustrate the concept of browsing and retrieval for this particular application.
4. Illustrate how video summarization will be helpful for video surveillance applications.
5. Illustrate using any one feature based tracking to classify normal vs abnormal behaviour for home surveillance application.

Concept Map

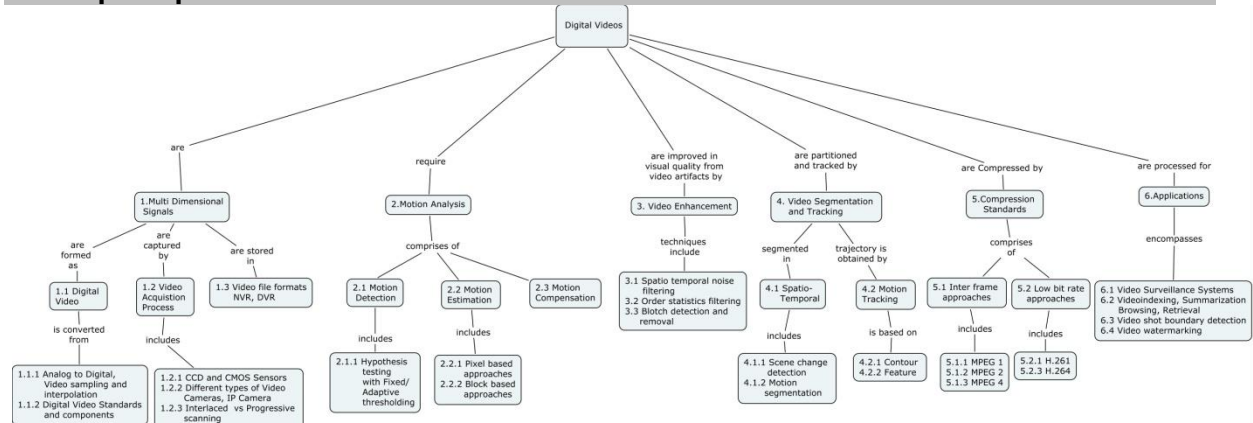

Syllabus

Digital video Formation: Introduction to digital video and digital video processing, Analog versus Digital, Analog to Digital, Digital Video Standards- Video acquisition, CCD and CMOS Sensors, Video sampling and interpolation- Interlaced and Progressive scanning- Video file formats- Storage devices, NVR, DVR- Different types of Video Cameras, IP Camera

Motion Analysis: Motion Detection – Hypothesis testing with Fixed/Adaptive thresholding Motion Estimation-Pixel based approaches- Block matching approaches- Motion compensation for videos

Video Enhancement: Video artifacts – Spatio-temporal noise filtering- Order statistics filtering, Blotch detection and Removal

Video Segmentation and Tracking: Scenechange detection- Motion segmentation-Video shot boundary detection- Motion tracking-contour based tracking-Feature based tracking

Video compression techniques: Inter frame coding-MPEG-1, MPEG-2 and MPEG-4 video compression standards – Low bit rate approaches- H.261 and H.264

Applications: Video Surveillance Systems -Videoindexing,summarization, browsing and retrieval- Video shot boundary detection– Video Watermarking

Text Books

14. Yao.Wang, Jom Ostermann, & Ya-Oin Zhang, “Video Processing & Communications”, Prentice Hall, 2002. (ISBN 0-13-017547-1)
15. Al Bovik, “Essential Guide to Video Processing”, Academic Press, 2009. (ISBN 978-0-12-37445)
16. Oge Marques, “Practical Image and Video Processing using MATLAB”, Wiley-IEEE Press., 2011. (ISBN: 978-0-470-04815-3)
17. A. Murat Tekalp, “Digital Video Processing, Pearson Education”, Prentice Hall, 2015. (ISBN-10: 0-13-399100-8)

Reference Books and Resources

18. Al Bovik, “Handbook of Image & Video Processing”, Academic Press, 2000. (ISBN: 0121197905)
19. J. W. Woods, “Multidimensional Signal, Image and Video Processing and Coding”, Academic Press, 2006. (ISBN 0-12-088516-6)
20. Iain E.G. Richardson, “H.264 and MPEG-4 Video Compression: Video Coding for Next Generation Multimedia”, Wiley, 2003. (ISBN: 978-0-470-86960-4)
21. Yun Q. Shi & Huifang Sun, “Image and Video Compression for Multimedia Engineering: Fundamentals, Algorithms, and Standards”, CRC Press, 2000. (ISBN: 0-8493-3491-8)
22. <https://www.coursera.org/course/images>.
23. <http://www.mathworks.com>.

Course Contents and Lecture Schedule

No.	Topic	No. of Lectures
1	Introduction to Digital Video Formation & Course Overview	
1.1	Multi Dimensional Signal: Introduction to Digital Video, Digital Video Processing and its applications, Course Objectives and Outcomes	2
1.1.1	Analog versus Digital, Analog to Digital, Video sampling and interpolation	2
1.1.2	Digital Video Standards and components	1
1.2	Video acquisition	1
1.2.1	CCD and CMOS Sensors	
1.2.2	Different types of Video Cameras, IP Camera	1

1.2.3	Interlaced and Progressive scanning	1
1.3	Video Storage: Video file formats, NVR, DVR	1
2	Motion Analysis	
2.1	Motion Detection	1
2.1.1	Hypothesis testing with Fixed/Adaptive thresholding	1
2.2	Motion Estimation	1
2.2.1	Pixel based approaches	1
2.2.2	Block matching approaches	2
2.3	Motion compensation for videos	1
3	Video Enhancement	
3.1	Video artifacts and Spatio temporal noise filtering	2
3.2	Order statistics filtering	1
3.3	Blotch detection and Removal	2
4	Video Segmentation and Tracking	
4.1	Spatio-Temporal Segmentation	2
4.1.1	Scene change detection	
4.1.2	Motion segmentation	1
4.2	Motion tracking	1
4.2.1	Contour based tracking	
4.2.2	Feature based tracking	1
5	Video compression techniques	
5.1	Inter frame coding approaches	1
5.1.1	MPEG-1 video compression standard	
5.1.2	MPEG-2 video compression standard	1
5.1.3	MPEG-4 video compression standard	1
5.2	Low bit rate approaches	
5.2.1	H.261	1
5.2.2	H.264	1
6	Applications	
6.1	Video Surveillance Systems	1
6.2	Video indexing, summarization, browsing and retrieval	2
6.3	Video shot boundary detection	1
6.4	Video Watermarking	1
	Total	36

Course Designer:

1.	Dr.B.Yogameena	ymece@tce.edu
----	----------------	---------------

14ECPQ0	MEDICAL IMAGING AND PROCESSING	Category	L	T	P	Credit
		PE	3	0	0	3

Preamble

The purpose of this course is to provide the basic concepts of various medical imaging modalities and the use of analysis tools for medical image reconstruction. It involves three different levels. In the lower level, the course introduces the terminology of medical imaging and explains how X-ray, CT, MRI and ultrasound images are generated. In the middle level, it addresses how to select the specific segmentation and classification methods for extracting meaningful information from the medical imaging modalities. In higher level, it addresses how to visualize and analyze 3D images.

Prerequisite

- 14EC570 Image Processing

Course Outcomes

On the successful completion of the course, students will be able to

CO1. Describe the various medical imaging modalities.	Understand
CO2. Apply the various reconstruction techniques on given images by observing the results	Apply
CO3. Apply the segmentation techniques and morphological operations for various medical images by solving problems	Apply
CO4. Analyze to choose the selective classifier.	Analyze
CO5. Visualize and analyse the given 3-D images.	Analyze

Mapping with Programme Outcomes

COs	PO 1	PO 2	PO 3	PO 4	PO 5	PO 6	PO 7	PO 8	PO 9	PO 10	PO 11	PO 12	PSO 1	PSO 2	PSO 3
CO1	M	L	-	-	-	-	-	L	-	-	-	-	L	-	-
CO2	S	M	L	-	M	L	-	M	M	L	-	-	M	M	L
CO3	S	M	L	-	M	L	-	L	M	L	-	-	M	M	L
CO4	S	M	L	L	M	L	-	-	M	L	-	-	M	M	L
CO5	S	M	L	L	-	-	-	-	-	-	-	-	L	-	-

S- Strong; M-Medium; L-Low

Assessment Pattern

Bloom's category	Continuous Assessment Tests			End Semester Examinations
	1	2	3	
Remember	20	20	20	20
Understand	40	40	20	20
Apply	40	40	40	40
Analyze	0	0	20	20
Evaluate	0	0	0	0
Create	0	0	0	0

Course Level Assessment Questions**COURSE OUTCOME 1(CO1):**

1. How T1-weighted spin echo is generated in MRI.
2. Explain how B-mode images are useful in the display of moving structures

3. What is the principle of X-ray Computer tomography?
4. Explain MRI principles in detail.
5. How are the longitudinal and transverse relaxation times computed?
6. What are the characteristic features of RF coils used in MRI?
7. How breast cancer is detected using Mammographic images.
8. Mention the principal feature of gradient echo pulse sequence.
9. List out the properties of ultrasound waves.

COURSE OUTCOME 2(CO2):

1. Mention the role of Sinogram in medical imaging reconstruction
2. What is central slice theorem? Explain
3. Derive any one filtered back projection algorithm with neat sketch.
4. Discuss about back projection filtering algorithm in detail.
5. Consider the following image:

6. 4	7. 5	8. 6	9. 9
10. 13	11. 14	12. 7	13. 7
14. 15	15. 16	16. 8	17. 4
18. 15	19. 16	20. 8	21. 3

Apply iterative reconstruction method and obtain the resultant image.

COURSE OUTCOME 3(CO3):

1. Write about watershed method in detail.
2. How active contour model is used to segment the image?
3. What is the use of Morphological Operation in medical image processing?
4. Erode the following region of 1's using a 3 X 3 square operator.

1	1	1	1	1	1	1	1	1
1	1	1	1	1	1	1	1	1
1	1	1	1	0	0	1	1	1
1	1	1	1	0	0	1	1	1

COURSE OUTCOME 4(CO4):

1. The Bayes decision functions $d_j(x)=p(x/\omega_j)p(\omega_j)$, $j=1,2,\dots,W$, were derived using a 0-1 loss function. Prove that these decision functions minimize the probability of error.(Hint: The probability of error $p(e)$ is $1-p(c)$ where $p(c)$ is the probability of being correct. For pattern vector x belonging to class ω_j $p(c/x)=p(\omega_j/x)$. Find $p(c)$ and show that $p(c)$ is maximum ($p(e)$ is minimum when $p(x/\omega_j) p(\omega_j)$ is maximum)
2. Mention the use of Bayesian Decision Making?
3. Specify the structure and weights of a neural network capable of performing exactly the same function as a bayes classifier for two pattern classes in n-dimensional space.
4. Design a neural net that classifies a sample as belonging to class 1 if the sample produces a positive value for $D = 34 + 8x_1-7x_2+x_3$ and classifies the samples as belonging to class 0 if the sample produces a negative value for D
5. Specify the structure and weights of a neural network capable of performing exactly the same function as a minimum distance classifier for two pattern class in N-dimensional place.
6. Describe the back propagation algorithm for neural network with 1 hidden layer.

COURSE OUTCOME 5(CO5):

1. List out the 3-D imaging operations
2. List out the steps involved in preprocessing of 3D visualization
3. Write shortly about scene based visualization and object based visualization
4. Explain in detail about scene based interpolation.
5. Explain the necessity of manipulation and analysis in 3D visualization

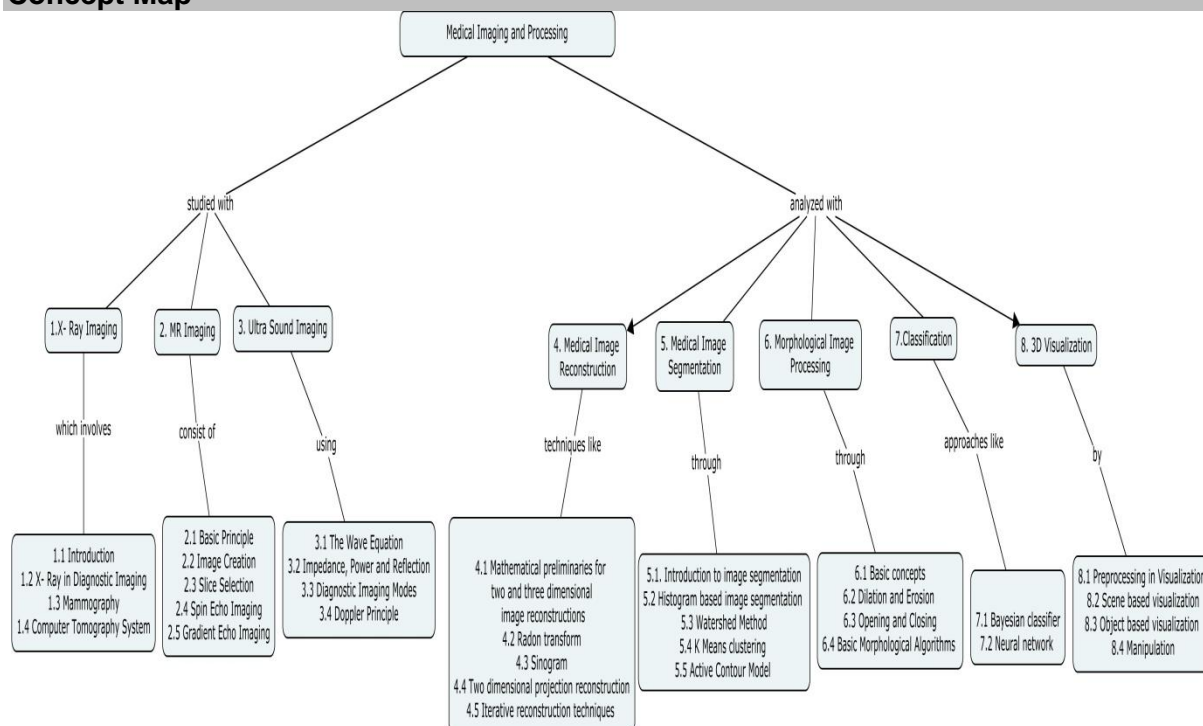
Concept Map**Syllabus**

Introduction to X-Ray Imaging- Introduction to imaging modalities-X-rays in Diagnostic imaging-Mammography-Computed tomography systems **Magnetic Resonance Imaging-** Basic principles of nuclear magnetic resonance-Image creation-slice selection-Spin- Echo Imaging, Gradient –Echo Imaging **Ultrasound Imaging-** The wave equation- Impedance, power and reflection – Diagnostic imaging modes- Doppler principle. **Medical Image Reconstruction:** Mathematical preliminaries for two and three dimensional image reconstructions-Radon transform – Sinogram - Two dimensional projection reconstruction-Iterative reconstruction techniques **Medical Image Segmentation:** Introduction to image segmentation – Histogram based image segmentation –Watershed Method – K Means clustering – Active Contour Model **Morphological Image Processing –** Basic concepts – Dilation and Erosion – Opening and Closing – Basic Morphological Algorithms. **Classification:-** Bayesian classifier-Neural network **3d Visualization-** Preprocessing in Visualization – Scene based visualization- Object based visualization – Manipulation

Text Books

1. Atam.P.Dhawan, "Medical Image Analysis", John Wiley and Sons ,2011
2. Geoff Dougherty, "Digital Image Processing for Medical Applications", Cambridge, 2009.

Reference Books

1. G. R. Sinha, Bhagwati Charan Patel, " Medical Image Processing (Concepts and Applications)" PHI Learning private Limited, 2014.
2. William.R.Hendee and Russell Ritenour.E. Woods, "Medical Imaging Physics", A John Wiley & sons , Inc. publications, 2002
3. Rafael.C.Gonzalez and Richard.E. Woods, "Digital Image Processing", Pearson Education, 2003

4. Issac Bankman and I.N.Bankman, " Handbook of Medical Imaging: Processing and Analysis", Academic press,2009
5. Zang-Hee Cho, Joie P. Jones, Manbir Singh, "Foundations of Medical Imaging", A John Wiley & sons , Inc. publications, 1993
6. Jacob Beutel and M.Sonka, "Handbook of Medical Imaging", volume 2. "Medical Image Processing and Analysis", SPIE press 2000.

Course Contents and Lecture Schedule

No.	Topic	No. of Lectures
1.	X-ray imaging	
1.1	Introduction	1
1.2	X-rays in Diagnostic imaging	
1.3	Mammography	2
1.4	computed tomography	2
2.0	MR imaging	
2.1	Basic principles	1
2.2	Image creation	1
2.3	slice selection	
2.4	Spin Echo Imaging	1
2.5	Gradient Echo Imaging	1
3.0	Ultra sound imaging	
3.1	The wave equation	1
3.2	Impedance, power and reflection	1
3.3	Diagnostic imaging modes	1
3.4	Doppler principle	1
4.0	Medical Image Reconstruction	
4.1	Mathematical preliminaries for two and three dimensional image reconstructions	1
4.2	Radon transform	1
4.3	Sinogram	1
4.4	Two dimensional projection reconstruction	2
4.5	Iterative reconstruction techniques	2
5.0	Medical Image Segmentation	
5.1	Introduction to image segmentation	2
5.2	Histogram based image segmentation	2
5.3	Watershed Method	1
5.4	K Means clustering	1
5.5	Active Contour Model	1
6.0	Morphological Image Processing	
6.1	Basic concepts	1
6.2	Dilation and Erosion	1
6.3	Opening and Closing	1
6.4	Basic Morphological Algorithms	2
7.0	Classification	
7.1	Bayesian classifier	1
7.2	Neural network	1
8.0	3-D Visualization	
8.1	Preprocessing	1
8.2	Scene based visualization	1
8.3	Object based visualization	1
8.4	Manipulation	1
	Total Number of Hours	38

Course Designers:

1. Dr.A.Banumathi, au_banu@tce.edu

14ECPR0	SATELLITE REMOTE SENSING	Category	L	T	P	Credit
		PE	3	0	0	3

Preamble

Remote sensing is the technology of acquiring, processing, and interpreting satellite images. Remote sensing involves the sensing of the Earth's surface from space by making use of the properties of electromagnetic waves emitted, reflected or diffracted by the sensed objects, for the purpose of improving natural resources management, land use and the protection of the environment. These applications are possible by extracting information from spectral images and then analyse them to understand various earth surface processes. GIS (Geographical Information System) is a multidisciplinary field that has been used for data integration, analysis and decision-making in many societal sectors. Integration of remote sensing and GIS technologies leads to the management of our renewable and non-renewable resources through efficient satellite image processing algorithms. This course provides the concepts of Remote Sensing, types, Image processing techniques used to process the satellite data and introduction to GIS.

Prerequisite:

NIL

Course Outcomes

On the successful completion of the course, students will be able to

CO1. Describe the electromagnetic remote sensing process and the platforms used for data acquiring process	Remember
CO2. Understand the different types remote sensing systems, data generated and their characteristics in terms of resolutions	Understand
CO3. Understand the image processing techniques to process the data.	Understand
CO4. Select and process the appropriate satellite images for specific applications	Apply
CO5. Integrate the satellite data with GIS for solving societal issues	Apply

Mapping with Programme Outcomes

COs	PO 1	PO 2	PO 3	PO 4	PO 5	PO 6	PO 7	PO 8	PO 9	PO 10	PO 11	PO 12	PSO 1	PSO 2	PSO 3
CO1	M	L	-	-	-	-	-	L	-	-	-	-	L	-	-
CO2	M	L	-	-	L	-	-	L	L	-	-	-	L	-	-
CO3	M	L	-	-	L	-	-	L	L	-	-	-	L	-	-
CO4	S	M	L	-	M	M	L	M	M	L	-	L	M	M	L
CO5	S	M	L	-	M	S	M	M	M	L	-	M	M	M	M

S- Strong; M-Medium; L-Low

Assessment Pattern

Bloom's Category	Continuous Assessment Tests			Terminal Examination
	1	2	3	
Remember	40	20	20	20
Understand	40	40	40	40
Apply	20	40	40	40
Analyze	0	0	0	0
Evaluate	0	0	0	0
Create	0	0	0	0

Course Level Assessment Questions

Course Outcome (CO1)

1. What is atmospheric window?
2. Define spectral reflectance of earth surface features.
3. What are the different types of remote sensing data?
4. Explain the across track scanning mechanism.
5. List out the elements used for satellite image interpretation.

Course Outcome (CO2)

1. The visible band play a critical role in many remote sensing systems. Why?
2. Differentiate diffuse and specular reflectance.
3. Compare across track and along track scanning methods.
4. Why hyper spectral scanning data is preferred for mineral mapping applications?
5. What are the advantages of microwave sensing over optical sensing?

Course Outcome (CO3)

1. Find the spatial resolution of a scanner having a 2.5 milliradian IFOV and operated from 1000m above the terrain.
2. How do we apply histogram equalization algorithm to enhance a satellite data.
3. A given SLAR system has a 2.0 mrad antenna beamwidth. Determine the azimuth resolution of the system at ranges of 5 and 10 km.
4. A side looking aperture radar transmits pulses over a duration of 0.2 microsecond. Find the resolution of the system at a depression angle of 45 degree.

Course Outcome (CO4)

1. If a multi spectral scanning image with a spatial resolution of 23m is given, how will you identify the earth surface features.
2. Assume, you are given MSS, Hyper spectral, SAR and LIDAR satellite data. What will be the appropriate classification strategies required to process each data. Justify your answer.
3. Object Oriented classification techniques are preferred for high resolution data processing. Comment.
4. Given a optical data and SLAR data, what are the interpretation elements referred to identify urban features.

Course Outcome (CO5)

1. Develop a Remote sensing and GIS based decision making system for water quality monitoring of a ward of a corporation.
2. Devise a GIS based methodology to identify suitable regions for paddy cultivation.
3. Design a GIS based database for tourism management in Madurai city.
4. Develop a Remote sensing and GIS based system for Air pollution monitoring of a city.

Concept Map

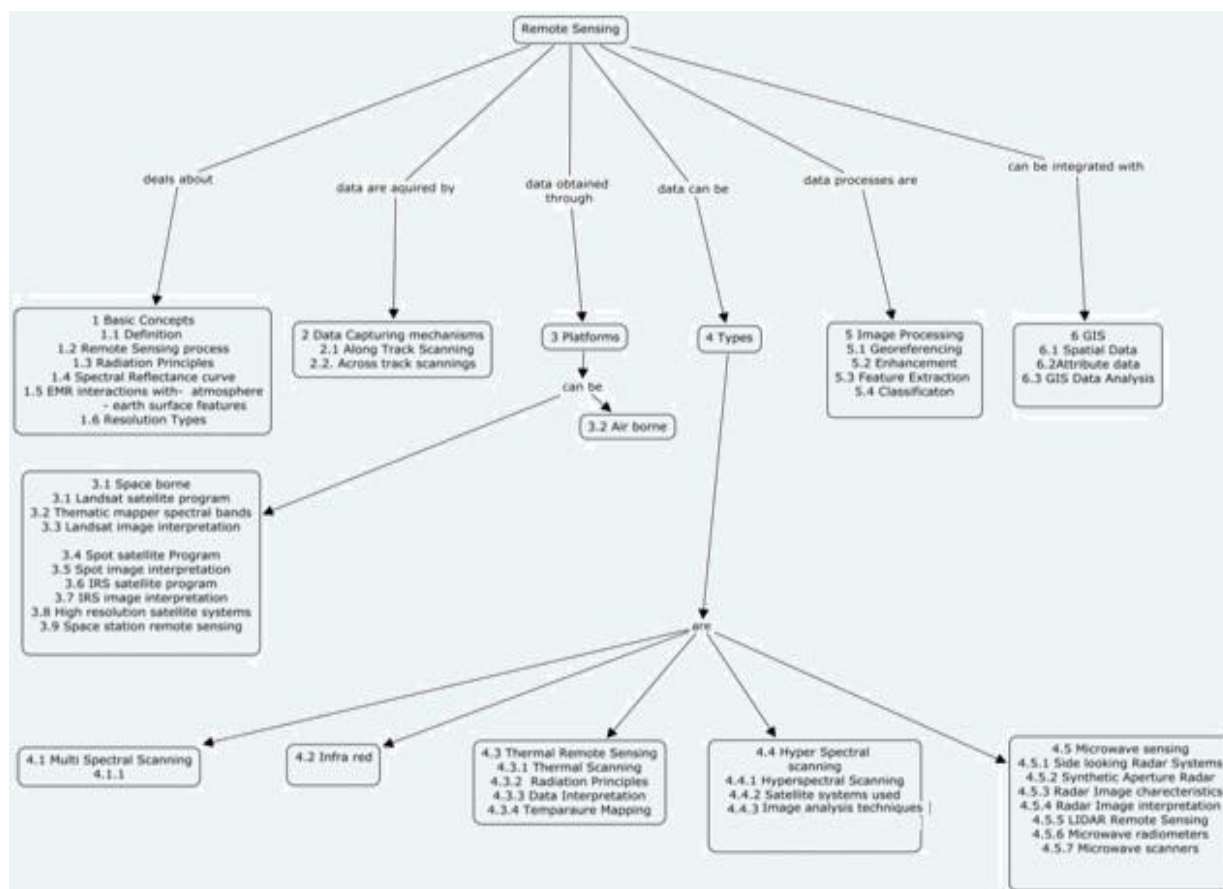

Syllabus

Basic concepts: Definition, Remote sensing process, Radiation principles, Spectral reflectance curve, EMR interactions with-atmosphere-earth surface features, Resolution types. **Data capturing mechanisms:** Along track scanning, Across track scannings. **Platforms:** Space borne, Landsat satellite program, Thematic mapper spectral bands, Landsat image interpretation, Spot satellite program, Spot image interpretation, IRS satellite program, IRS image interpretation, High resolution satellite system, Space station remote sensing, Air borne. **Types:** Multi spectral scanning, Infrared, Thermal remote sensing, Thermal scanning, radiation principles, Data interpretation, temperature mapping, Hyper spectral scanning, satellite systems used, Image analysis techniques. Microwave sensing, Side looking radar systems, Synthetic aperture radar, Radar image characteristics, Radar image interpretation, LIDAR remote sensing, Microwave radiometers, Microwave scanners. **Image processing:** Georeferencing, Enhancement, Feature extraction, Classification. **GIS:** Spatial data, Attribute data, GIS data integration and analysis.

Text Book

1. Thomas M.Lillesand, Ralph W.Kiefer, "Remote Sensing And Image Interpretation", Fifth Edition, 2004.

Reference Books

1. John R. Jensen, "Remote Sensing Of The Environment – An Earth Resource Perspective", Pearson Education Series, 2003.
2. Rafael C.Gonzalez, Richard E.Woods, "Digital Image Processing" (3rd Edition) Rafael C.Gonzalez, Richard E.Woods, Prentice Hall, 2007.
3. Robert A. Schowengerdt, Remote Sensing Models & Methods For Image Processing, III Edition, 2004.
4. J. A. Richards "Remote Sensing Digital Image Analysis: An Introduction", Second Revised Edition, 1993.

Course Contents and Lecture Schedule

No.	Topic	No. of Lectures
1	Basic concepts	
1.1	Definition	1
1.2	Remote Sensing Process	1
1.3	Radiation Principles	1
1.4	Spectral Reflectance Curve	1
1.5	EMR Interactions with-atmosphere-earth surface features	1
1.6	Resolution Types	1
2	Data capturing Mechanisms	
2.1	Along Track Scanning	0.5
2.2	Across track scanning	0.5
3	Platforms	
3.1	Space borne	0.5
3.1.1	Landsat satellite program	1
3.1.2	Thematic mapper spectral bands	1
3.1.3	Landsat image interpretation	1
3.1.4	Spot satellite program	1
3.1.5	Spot image interpretation	1
3.1.6	IRS satellite program	1
3.1.7	IRS image interpretation	1
3.1.8	High resolution satellite system	1
3.1.9	space station remote sensing	0.5
3.2	Air borne	1
4	Types	
4.1	Multi spectral Scanning & Infrared scanning	1
4.2	Thermal remote sensing, Thermal scanning, Radiation principles	1
4.3	Data interpretation, Temperature mapping	0.5
4.4	Hyper spectral scanning, Satellite systems used	1.5
4.5	Image analysis techniques.	1
4.6	Microwave sensing, side looking radar systems, synthetic aperture radar	2
4.7	Radar image characteristics, radar image interpretation,	1.5
4.8	LIDAR remote sensing	1
4.9	Microwave radiometers	1
4.10	Microwave scanners	1
5	Image processing	
5.1	Georeferencing	1
5.2	Enhancement	1
5.3	Feature extraction	1
5.4	Classification	1.5
6	GIS	
6.1	Spatial data	1
6.2	Attribute data	1
6.3	GIS data Integration and analysis	2
Total Periods		36

Course Designers

1. Dr.R.A.Alagu Raja alaguraja@tce.edu
2. Dr.B.Sathya Bama sbece@tce.edu

14ECPS0	INTERNET OF THINGS	Category	L	T	P	Credit
		PE	3	0	0	3

Preamble

The objectives of this course are to provide in-depth understanding of the underlying concepts of Internet of things, building blocks, domain-specific IoTs, and Design methodology for IOT. Also the course provides knowledge on Python coding to embed the coding in various open source hardware such as Raspberry Pi and Arduino. Eventually the course extends the students' knowledge upto the level of building cost effective IOT system for real world scenario with the open source hardware and software tool chains.

Prerequisite

14EC370- Microprocessor Architecture and Programming
 14EC320-Problem Solving using Computer
 14EC420-Microcontrollers
 14EC510-Data Communication Networks

Course Outcomes

On the successful completion of the course, students will be able to

CO1. Recollect the terms and definitions of embedded system and networking	Remember
CO2. Understand the details and functionality of architecture of IOT	Understand
CO3. Identify different hardware and software tools for the IOT implementation	Understand
CO4. Design an IOT system for the given scenario and able to evaluate the constraints of the system.	Apply
CO5. Choose the suitable hardware and software tools chains for the given real world scenario to fulfill the IOT requirements	Apply
CO6. Analyze the features and operations of various features of the open source hardware	Analyze

Mapping with Programme Outcomes

COs	PO 1	PO 2	PO 3	PO 4	PO 5	PO 6	PO 7	PO 8	PO 9	PO 10	PO 11	PO 12	PSO 1	PSO 2	PSO 3
CO1	M	L	-	-	S	-	-	L	M	L	-	-	L	-	-
CO2	M	L	-	-	S	-	-	L	M	L	-	-	L	-	-
CO3	M	L	-	-	S	-	-	L	M	L	-	L	L	-	L
CO4	S	M	L	-	S	-	-	L	M	L	-	L	M	-	L
CO5	S	M	L	-	S	-	-	M	L	L	-	L	M	-	L
CO6	S	M	L	-	S	-	-	L	M	L	-	L	M	-	L

S- Strong; M-Medium; L-Low

Assessment Pattern

Bloom's Category	Continuous Assessment Tests			Terminal Examination
	1	2	3	
Remember	20	0	0	0
Understand	20	20	20	30
Apply	60	60	60	50
Analyse	0	20	20	20
Evaluate	0	0	0	0
Create	0	0	0	0

Course Level Assessment Questions

Course Outcome 1 (CO1)

1. Mention important benefits of IOT
2. What are the key functions of IOT?
3. Identify the components for weather reporting with IOT .
4. What do you mean by IOT protocol?
5. Describe and compare the network architectures of OSI model and TCP/IP Model.

Course Outcome 2 (CO2)

1. What are the advantages of having a switch rather than a hub to interconnect several machines?
2. What is the use of cloud for IOT?
3. Why protocol is necessary for IOT routing?
4. Describe how an algorithm is used in configuring a IOT network.
5. How does OSHW support for IOT

Course Outcome 3 (CO3)

1. Identify the components of IOT.
2. Compare the roles of switch and router.
3. What is the roll of cloud for IOT in different scenario?
4. Why is the roll of different protocol for IOT?
5. Suggest the sensors for IOT for the given application

Course Outcome 4 (CO4)

1. Explain how route optimization is done in IOT.
2. Develop pseudo code for accessing sensors in python
3. Develop an arduino code for accessing sensors and actuators

Course Outcome 5 (CO5)

1. Consider a point to point link 50 Km. in length. At what bandwidth would propagation delay equal transmit delay for 100 bytes packet? What about 512 byte packets?
2. Develop an IOT System with sensors for monitoring agriculture field
3. Develop an IOT System with sensors for street light monitoring and control

Course Outcome 6 (CO6)

1. Compute the propagation delay of an IOT system when an algorithm is running with a defined rate and networking delay
2. Analyse the criticality, implementation issues and constrain of the IOT system for the give real world scenario

Concept Map

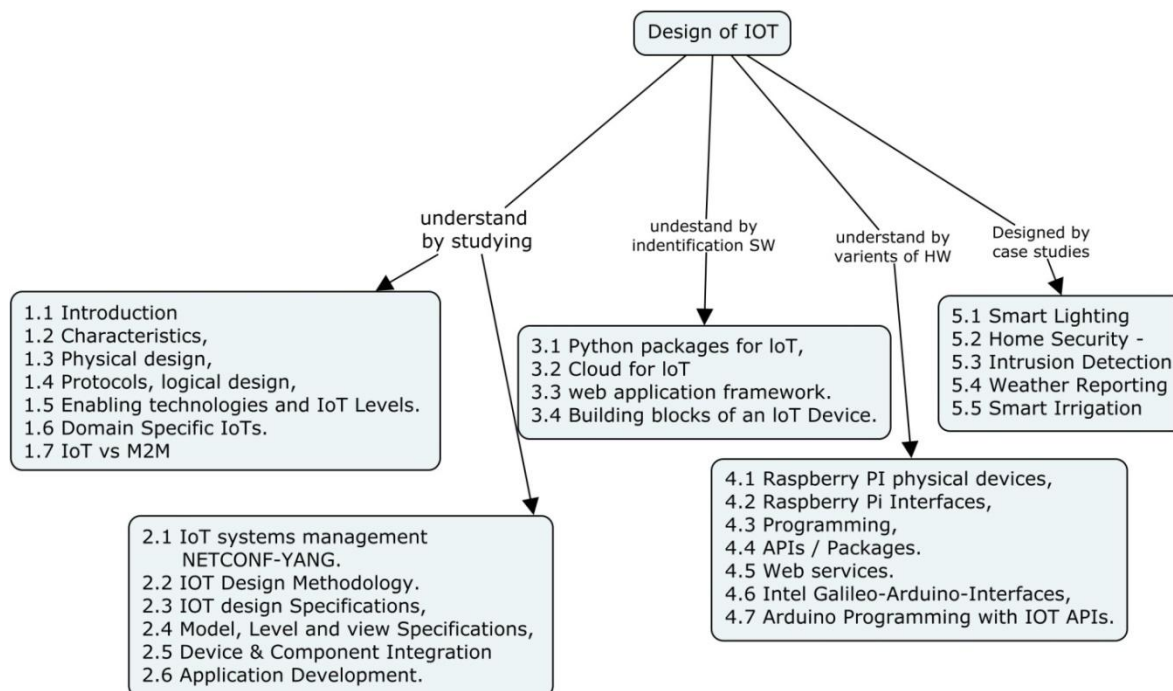

Syllabus

INTRODUCTION TO IOT: Introduction, Characteristics, Physical design, Protocols, logical design, Enabling technologies and IoT Levels. Domain Specific IoTs. IoT vs M2M. **DESIGN METHODOLOGY:** IoT systems management with NETCONF-YANG. IoT Design Methodology. IOT design Specifications, Model, Level and view Specifications, Device & Component Integration and Application Development. **LOGICAL DESIGN& PHYSICAL Devices:** Python packages of interest for IoT, Cloud for IoT, python web application framework. Basic building blocks of an IoT Device. **OPEN SOURCE HARDWARE:** Raspberry PI physical devices, Raspberry Pi Interfaces, Programming, APIs / Packages. Web services. Intel Galileo-Arduino-Interfaces, Arduino Programming with IOT APIs. **CASE STUDIES:** Real time applications of IoT-Connecting IoT to cloud.

Course Contents and Lecture Schedule

Module No	Topic	No.of Lectures
1	INTRODUCTION TO IOT	
1.1	Definition & Characteristics and Physical Design of IOT	1
1.2	Logical Design, Functional Blocks and Communication Models	1
1.3	Enabling Technologies, Levels & Deployment Templates	1
1.4	Domain Specific IoTs (Smart Lighting, Smart Appliances Intrusion Detection)	1
1.5	IoT and M2M-differences	1
2	DESIGN METHODOLOGY	
2.1	IoT systems management with NETCONF-YANG	1
2.2	IOT Design Specifications	1
2.3	Model, Level and view Specifications	1
2.4	Device & Component Integration	1
2.5	Application Development	1

2.6	Basic building blocks of an IoT Device	1
3	LOGICAL DESIGN& PHYSICAL DEVICES	
3.1	Introduction to Python	2
3.2	Control Flow Functions Modules Packages for IOT	2
3.3	Cloud for IoT	2
3.4	Python web application framework	2
3.5	Programming, APIs / Packages	2
4	OPEN SOURCE HARDWARE	
4.1	Raspberry PI physical devices	3
4.2	Raspberry Pi Interfaces	3
4.3	Web services	3
4.4	Intel Galileo-Arduino-Interfaces	3
4.5	Arduino Programming with IOT APIs	3
5	CASE STUDIES	
5.1	Smart Lighting	1
5.2	Home Security -Intrusion Detection	1
5.3	Weather Reporting Bot	1
5.4	Smart Irrigation	1

Text Books

1. Arshdeep Bahga, Vijay Madiseti, "Internet of Things – A hands-on approach", Universities Press, 2015
2. Peter Waher "Learning Internet of Things", Packt Publishing,UK, 2015.
3. Miguel de Sousa",Internet of Things with Intel Galileo" ", Packt Publishing,UK, 2015

Reference Books

1. Marco Schwartz, "Internet of Things with the Arduino Yun", Packt Publishing, 2014
2. Adrian McEwen, Hakim Cassimally "Designing the Internet of Things",Wiley Publishing, 2015
3. Manoel Carlos Ramon, "Intel® Galileo and Intel® Galileo Gen 2: API Features and Arduino Projects for Linux Programmers", Apress, 2014

Course Designers:

1. Dr. K.Hariharan khh@tce.edu
2. Dr. L.R.Karlmarx lrk@tce.edu

14ECPT0	RADIO FREQUENCY INTEGRATED CIRCUITS	Category	L	T	P	Credit
		PE	3	0	0	3

Preamble

This course introduces the principles, analysis, and design of CMOS Radio frequency (RF) integrated circuits for wireless communication systems. Besides system level design considerations for RFIC, this course also presents rule-of-thumbs in designing RF main blocks such as Low-Noise-Amplifier (LNA), mixer, Voltage-Controlled-Oscillator (VCO), and Phase-Locked-Loop (PLL). Students are supposed to understand architectures of RF system and master the keypoint of designing RF Integrated circuits. They are also required to design circuits and do simulation with EDA tools.

Prerequisite

14EC520 : Digital CMOS Systems

Course Outcomes

On the successful completion of the course, students will be able to

CO1	Understand the fundamentals of RF integrated circuits operating at Radio Frequencies	Understand
CO2	Discuss active and passive device technologies relevant to RFICs and their relative performance advantages and disadvantages	Apply
CO3	Design and Implementation of Low Noise Amplifier based on foundry models for Wireless Communication Systems	Apply
CO4	Design and Implementation of Power amplifier for portable applications	Apply
CO5	Design and analyze different types of Phase Locked Loops.	Analyse
CO6	Analyse the RF mixer circuit based on noise figure, conversion gain and implementation in CMOS technology	Analyse

Mapping with Programme Outcomes

COs	PO 1	PO 2	PO 3	PO 4	PO 5	PO 6	PO 7	PO 8	PO 9	PO 10	PO 11	PO 12	PSO 1	PSO 2	PSO 3
CO1	M	L	-	-	-	-	-	-	-	-	-	L	-	-	-
CO2	S	M	L	-	-	-	-	-	L	-	-	L	S	-	-
CO3	S	M	L	-	-	-	-	-	-	-	-	L	S	-	-
CO4	S	M	L	-	-	-	-	-	-	-	-	L	S	-	-
CO5	S	S	M	-	-	-	-	-	L	-	-	L	S	-	-
CO6	S	S	M	-	-	-	-	-	L	-	-	L	S	-	-

S- Strong; M-Medium; L-Low

Assessment Pattern

Bloom's category	Continuous Assessment Tests			End Semester Examinations
	1	2	3	
Remember	20	20	0	0
Understand	40	30	20	20
Apply	40	50	60	60
Analyze	0	0	20	20
Evaluate	0	0	0	0
Create	0	0	0	0

Course Level Assessment Questions

Course Outcome 1 (CO1):

1. Give any one expression for Q and state its units.
2. Distinguish between a heterodyne receiver and homodyne receiver.
3. Define: ACPR.
4. List out the various circuit level parameters used in RFIC.

Course Outcome 2 (CO2):

1. Determine the quality factor of the tank with respect to R, C, and L.

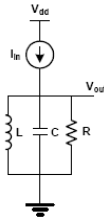

2. The mean square thermal noise density of a resistor in the room temperature is . If this resistor is used in a first-order RC filter as shown in Fig. 1, and the noise bandwidth of the RC filter is , calculate the value of C in Fig.1. Present the details of your calculations.
 $33 \times 10^{-17} \text{ V}^2/\text{Hz}$ 50 MHz .

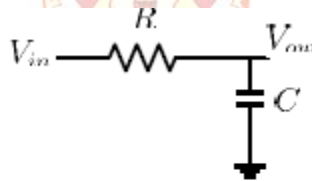
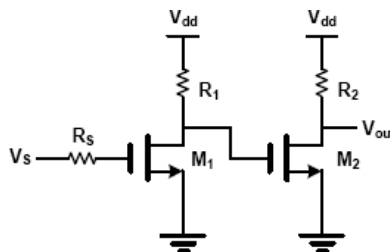

Fig. 1. A single-pole RC filter.

3. Draw the circuit diagram of a typical inductor degenerated MOSFET LNA.
4. Draw the high frequency equivalent circuit of MOSFET.
5. Explain the different choices of realization of RF inductors and capacitors in CMOS technology. Why these are different in compared to the conventional lumped component inductors and capacitors.

Course Outcome 3(CO3):

1. Fig. 1 shows a two-stage amplifier schematic. Determine the noise factor of this amplifier. Consider only the thermal noise sources and ignore the gate noise of the transistors. Ignore all the parasitics and assume that the transistors are long-channel devices and $\lambda_n = 0$.



2. A common-source low noise amplifier (LNA) with feedback is shown in Fig. is the input source resistance. Assume that the transistors are long-channel devices and

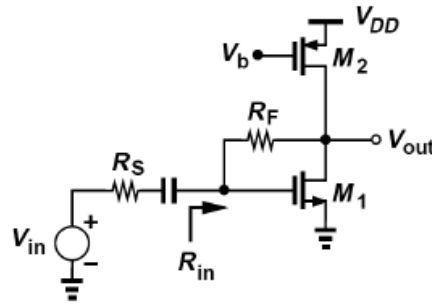

- Determine the input impedance (R_{in}) of the LNA.
- Calculate the voltage gain of the LNA (i.e. V_{out}/V_{in}) after matching if $R_F = 25R_S$.
- Derive an expression for the output noise of the LNA contributed by R_S after matching. Assume $R_F \geq R_S$.

- Consider the wideband common-gate low noise amplifier (LNA) shown in Figure is the input source resistance. Assume that the transistors are long-channel devices with $\gamma = 0$. Also assume that $\gamma_{body\ effect} = 0$.

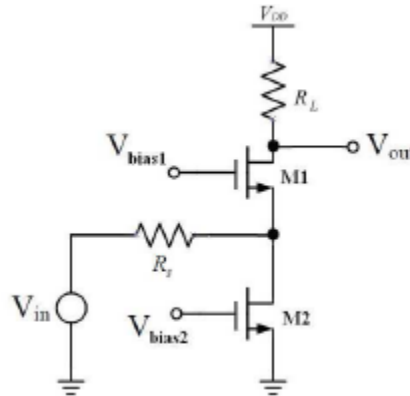

- Calculate the input impedance of the LNA. Assume that we can neglect all parasitic associated with the transistors.
- Derive an expression for the noise figure of the LNA. Only consider the thermal noise sources and ignore the gate noise of the transistors. Also assume that is a noiseless resistor.

Course Outcome 4(CO4):

- The following table lists three different properties for the A, B, C, D, and E power amplifier classes and their typical values. Identify the power amplifier class for each column.

Maximum drain efficiency [%]	100	78.5	100	50	100
Peak drain voltage [$*V_{DD}$]	2	2	1	2	3.6
Normalized power output capability [$P_{out}/(\max V \text{ and } I)$]	0.125	0.125	0.32	0.125	0.098
Power Amplifier Class					

- How would you select the gate-bias $V_{g,bias}$ for a class-AB power amplifier?
- What are the performance trade-offs when choosing this $V_{g,bias}$ -value?
- What is the purpose of a "load-pull characterization" of a power amplifier?

Course Outcome 5(CO5):

- For the frequency-multiplying PLL shown below, determine the:

- a. closed-loop transfer function
- b. damping factor ζ
- c. natural frequency ω_n
- d. loop bandwidth

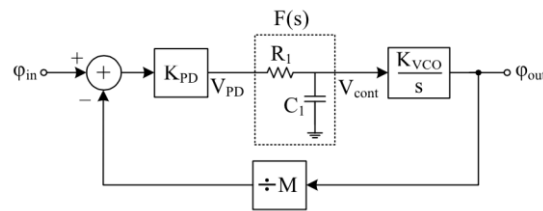

2. Explain how a type-I PLL operates as a FSK demodulator, if the VCO control voltage is considered as the output.
3. Figure show the waveforms of PFD and charge pump in a type-II PLL. Using this figure, determine the transfer function of this combination.

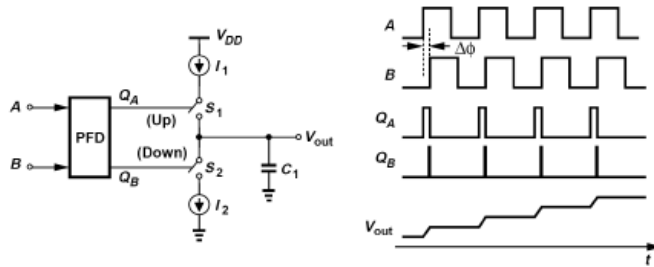

Course Outcome 6(CO6):

1. A single-balanced mixer is shown in Fig. Assume that the switching transistors M1 and M2 are ideal switches with zero on-resistance and .

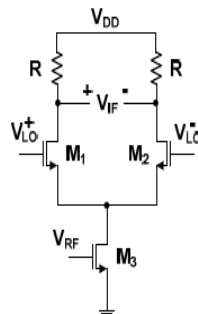

- (a) Derive an expression for the conversion gain of this mixer.
 - (b) Derive an expression for the noise figure of this mixer. Assume the switching transistors do not generate noise. The total noise is contributed by transistor M3, load resistors R and source resistor R_s connected to the RF input (is not shown in the figure). Consider only the thermal noise sources and ignore the gate noise of the transistor.
2. The circuit shown in Fig. is a dual-gate mixer used in traditional microwave design. Assume abrupt edges and a 50% duty cycle for the LO, and neglect channel-length modulation and body effect.

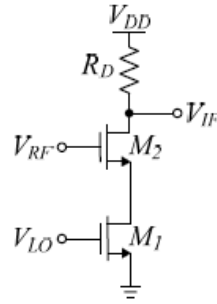

- (a) Assume that $M1$ is an ideal switch. Determine all the frequency components which appear at the mixer IF port.
- (b) Assume when $M1$ is on, it has an on-resistance of R_{on1} . Compute the voltage conversion gain of the circuit. Assume $M2$ does not enter the triode region and denote its transconductance by g_{m2} .
- (c) Assume that $M1$ is an ideal switch (noise contribution is zero). Derive the expression for the noise figure of the mixer.

3. Prove that the voltage conversion gain of a sampling mixer approaches 6 dB as the width of the LO pulses tends to zero (i.e., as the hold time approaches the LO period).

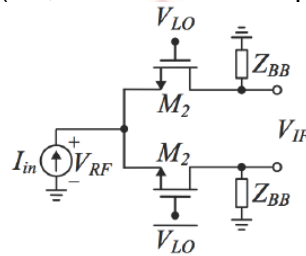

Concept Map

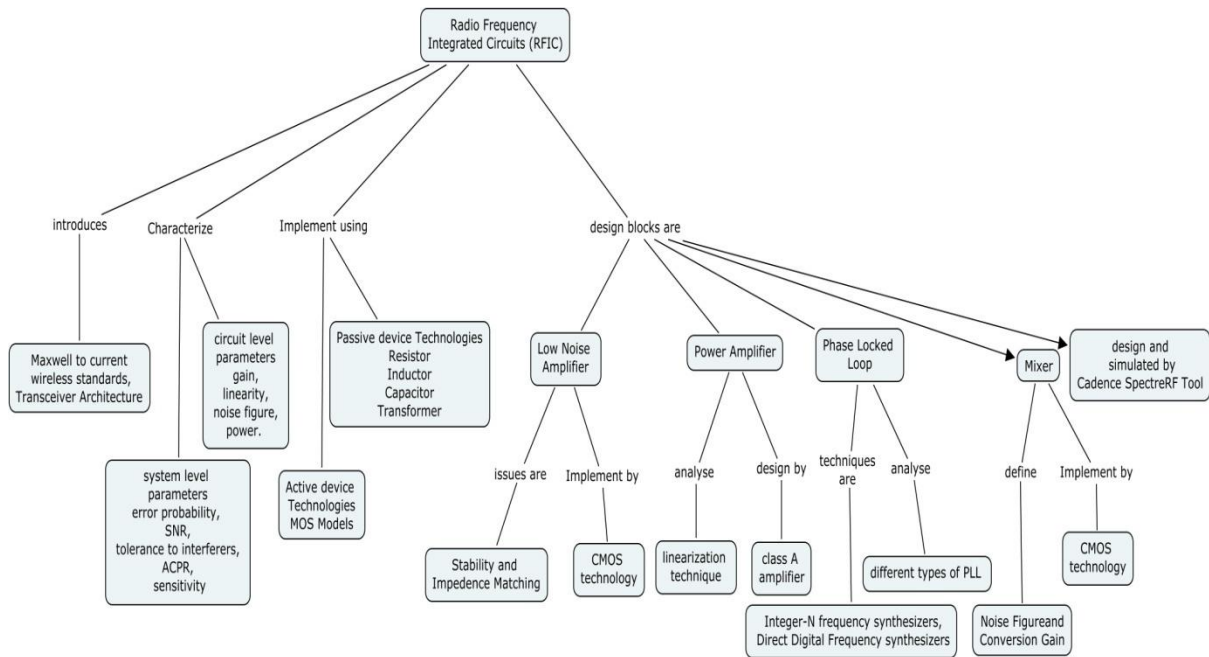

Syllabus

RFIC Design Basics: Historical Aspects – From Maxwell to Current Wireless standards, The bridge between communication system designer and RF IC Designer: Comm. System characterization, RF System characterization, Transceiver Architectures, System-level parameters: error probability, SNR, tolerance to interferers, ACPR, sensitivity, Circuit-level parameters: gain, linearity, noise figure, power.

The CMOS technology for RF: MOS models for RF, Characteristics of passive IC components at RF frequencies – interconnects, resistors, capacitors, inductors and transformers Transmission lines Classical two-port noise theory, Noise models for active and passive components.

Low Noise Amplifier: Tuned Low-Noise Amplifiers, Other LNA topologies, Design of LNA using EDA tools.

Power Amplifier: Stability of feedback systems: Gain and phase margin, Root-locus techniques, Time and Frequency domain considerations, Compensation, Classes of power amplifiers, Design of Power amplifier using EDA tools

Phase- Locked Loop: PLL Model, Loop filters and Charge pumps, Integer-N frequency synthesizers, Direct Digital Frequency synthesizers, Design of Phase Locked Loop and performance analysis using EDA tools.

Mixer: Active mixers, Passive and polyphase filters, Design of a mixer based on a Gilbert cell using SpectreRF.

Text Books:

1. Behzad Razavi, RF Microelectronics, 2nd Ed., Prentice Hall, Reprint 2012.
2. Thomas. H. Lee, The Design of CMOS Radio Frequency Integrated Circuits, Cambridge, U.K., Cambridge University Press, 2004.

Reference Books:

1. John W.M.Rogers and Calvin Plett, "Radio Frequency Integrated Circuit Design", 2nd Edition, Artech House, Norwood, 2010.
2. Devendra.K. Misra, "Radio Frequency and Microwave Communication Circuits – Analysis and Design", John Wiley and Sons, Newyork, 2004.
3. Wayne Wolf, Modern VLSI design, Pearson Education, 2003

Course Contents and Lecture Schedule

Module No	Topic	No.of Lectures
1	RFIC Design Basics	
1.1	Historical Aspects – From Maxwell to Current Wireless standards	1
1.2	The bridge between communication system designer and RF IC Designer: Comm. System characterization, RF System characterization	1
1.3	Transceiver Architectures	1
1.4	System-level parameters: error probability, SNR, tolerance to interferers, ACPR, sensitivity	2
1.5	Circuit-level parameters: gain, linearity, noise figure, power	2
2	The CMOS technology for RF	
2.1	MOS models for RF	2
2.1	Characteristics of passive IC components at RF frequencies – interconnects, resistors, capacitors, inductors and transformers	3
2.3	Transmission lines Classical two-port noise theory, ,	2
2.4	Noise models for active and passive components	3
3	Low Noise Amplifier	
3.1	Tuned Low-Noise Amplifiers	2

3.2	Other LNA topologies	2
3.3	Design of LNA using EDA tools	3
4	Power Amplifier2	
4.1	Stability of feedback systems: Gain and phase margin, Root-locus techniques, Time and Frequency domain considerations, Compensation	2
4.2	Classes of power amplifiers	3
4.3	Design of Power amplifier using EDA tools	3
5	Phase- Looked Loop	
5.1	PLL Model	1
5.2	Loop filters and Charge pumps	2
5.3	Integer-N frequency synthesizers, Direct Digital Frequency synthesizers.	2
5.4	Design of Phase Locked Loop and performance analysis usin EDA tools.	3
5.5	Hardware Demos of PLL chipset	1
6	Mixer	
6.1	Active mixers	1
6.2	Passive and polyphase filters	2
6.3	Design of a mixer based on a Gilbert cell using EDA tools	3
6.4	Hardware Demos of Mixer	1

Course Designers:

1.	Dr.S.Raju	rajuabhai@tce.edu
2.	Dr.D.Gracia Nirmala Rani	gracia@tce.edu

14ECPU0	RF SYSTEM DESIGN AND MEASUREMENTS	Category	L	T	P	Credit
		PE	3	0	0	3

Preamble

The purpose of this course is to provide the conceptual understanding of RF receiver Parameters, architectures with their different issues. It also focuses on the system design. This course provides insight into practical RF receiver measurements. The RF system integration issues are also presented.

Prerequisite

RF Transmission lines and passive circuits, RF active circuits, Antennas and Wave Propagation

Course Outcomes

On the successful completion of the course, students will be able to

CO1	Understand the receiver parameters.	Understand
CO2	Apply the receiver parameters to design receiver architectures.	Apply
CO3	Analyze the receiver design and parameter measurements towards the development of high frequency RF front ends.	Analyze
CO4	Design and develop a RF receiver model for the given specification.	Apply
CO5	Measure the receiver parameters	Apply

Mapping with Programme Outcomes

COs	PO 1	PO 2	PO 3	PO 4	PO 5	PO 6	PO 7	PO 8	PO 9	PO 10	PO 11	PO 12	PSO 1	PSO 2	PSO 3
CO1	M	L	-	-	-	-	-	-	-	-	-	L	-	-	-
CO2	S	M	L	-	-	-	-	-	-	-	-	L	S	-	-
CO3	S	S	M	-	-	-	-	-	S	-	-	L	S	-	-
CO4	S	M	L	-	-	-	-	-	S	-	-	L	S	-	-
CO5	S	M	L	-	-	-	-	-	S	-	-	L	S	-	-

S- Strong; M-Medium; L-Low

Assessment Pattern

Bloom's Category	Continuous Assessment Tests			Terminal Examination
	1	2	3	
Remember	0	0	0	0
Understand	30	30	30	20
Apply	50	50	50	60
Analyze	20	20	20	20
Evaluate	0	0	0	0
Create	0	0	0	0

Course Level Assessment Questions**CO1:**

1. A cellular system uses FDMA with a spectrum allocation of 12.8MHz in each direction, a guard band of 10 kHz at the edge of the allocated spectrum, and a channel bandwidth of 30 kHz. How many channels are available?

2. A GEO satellite is in an equatorial orbit with orbital period $t_s = 24$ h. It appears stationary over a fixed point on the earth surface. Verify that the altitude of a GEO satellite is 35,784 km.
3. For what distances is the two-ray plane earth loss model valid in a macrocell ($ht = 50$ m and $hr = 2$ m) and a microcell ($ht = 10$ m and $hr = 2$ m)? Consider the frequencies 900 MHz and 1800 MHz.

CO2:

1. Determine the maximum Doppler shift for a mobile moving at 50 and 100 km/h at frequencies of 1 GHz and 2 GHz.
2. If a user makes 10 calls per day with an average call duration of 6 minutes, what is the traffic due to this caller?
3. The GSM system transmits at 270.8 kbits/s to support 8 users per frame. If each user occupies one time slot per frame, what is the raw data rate for each user? In each time slot, guard and other overheads consume a rate of 10.1 kbits/s. What is the user traffic efficiency?

CO3:

1. For a telephone channel in the frequency range 300 Hz to 3000 Hz, (a) select a power efficient constellation to achieve a data rate of 9600 bits/s. (b) Assuming an ideal channel, if root-raised-cosine pulse is used as the transmitter pulse, select the roll-off factor.
2. A pager operating at a center frequency of 100 MHz has a noise bandwidth of 10 kHz. If the antenna efficiency is 40 percent and the noise figure is 10 dB, what is the minimum signal power into the receiver for a SNR of 5 dB?
3. Determine the available power in dBm at room temperature in a 10 MHz bandwidth for a resistance $R = 100$ k Ω . (Hint: the noise power $P = kTB$.)

CO4:

1. Experimentally how will we converge 3G and 4G.
2. Design the specification of the receiver blocks.

CO5:

1. Design a quarter-wave transformer to match a 50 Ω to a 75 Ω cable. Plot the VSWR for $0.5 \leq f/f_0 \leq 2.0$, where f_0 is the frequency at which the line is $\lambda/4$ long.
2. Using Spectrum Analyzer, measure and plot the S parameter of a given RF Board.
3. Using Spectrum Analyzer, measure the functionality of each section and give the inference about the result.

Concept Map

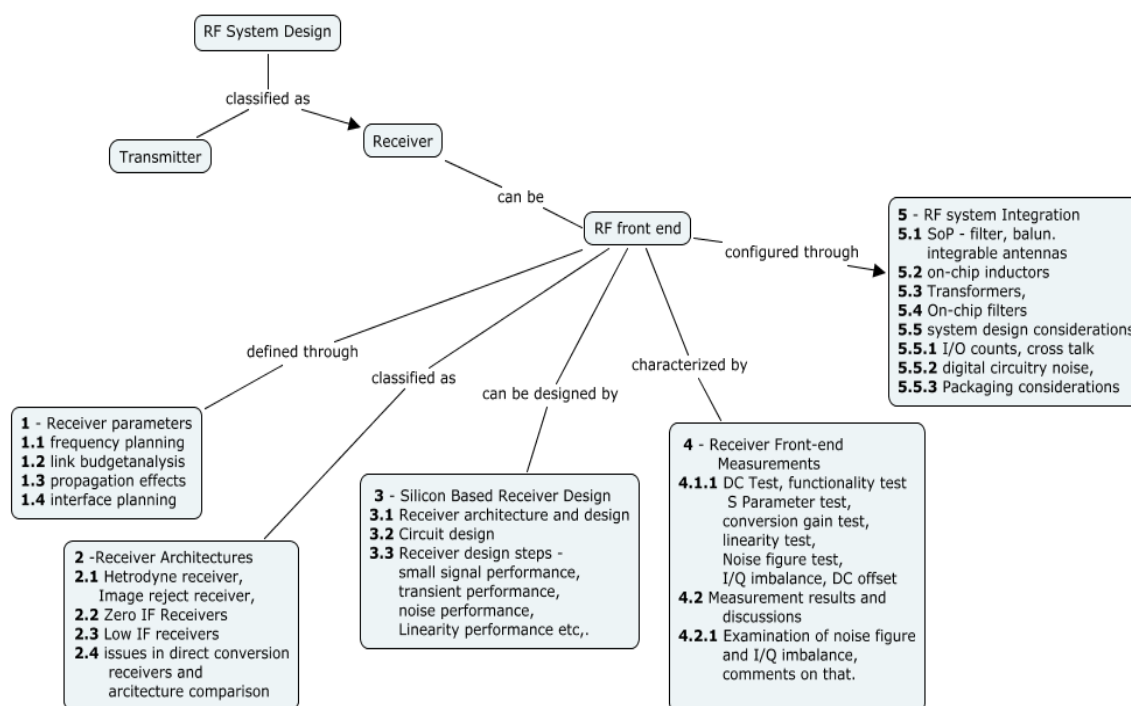

Syllabus

Introduction – Current state of art.

Module 1 - RF SYSTEM DESIGN: Frequency Planning - Blockers, Spurs and Desensing, Transmitter Leakage, LO Leakage and Interference, Image, Half IF, **Link Budget Analysis** – Linearity, Noise, Signal-to-Noise Ratio, Receiver Gain, **Propagation Effects** - Path Loss, Multipath and Fading, Equalization, Diversity, Coding, **Interface Planning**.

Module 2 - REVIEW OF RECEIVER ARCHITECTURES: Heterodyne Receivers, Image Reject Receivers - Hartley Architecture, Weaver Architecture, **Zero IF Receivers, Low IF Receivers**, Issues in Direct Conversion Receivers – Noise, LO Leakage and Radiation, Phase and Amplitude Imbalance, DC Offset, Intermodulations, Architecture Comparison and Trade-off.

Module 3 - SILICON-BASED RECEIVER DESIGN: Receiver Architecture and Design - System Description and Calculations, Basics of OFDM, System Architectures, System Calculations, **Circuit Design** - SiGe BiCMOS Process Technology, LNA, Mixer, Frequency Divider, **Receiver Design Steps**- Design and Integration of Building Blocks, DC Conditions, Scattering Parameters, Small-Signal Performance, Transient Performance, Noise Performance, Linearity Performance, Parasitic Effects, Process Variation, 50-Ω and Non-50-Ω Receivers, Layout Considerations

Module 4- RECEIVER FRONT-END MEASUREMENTS - DC Test, Functionality Test, S-Parameter Test, Conversion Gain Test, Linearity Test, Noise Figure Test, I/Q Imbalance, DC Offset, **Measurement Results and Discussions** - Close Examination of Noise Figure and I/Q Imbalance, Comments on I/Q Imbalance.

Module 5 – RF SYSTEM INTEGRATION: System on Package (SoP) - Multilayer Bandpass Filter, Multilayer Balun Structure, Module-Integrable Antennas, Fully Integrated SoP Module, **On-Chip Inductors** - Inductor Modeling, Inductor Parameters, Application in Circuits, Capacitors, Differentially Driven Inductors, **Transformers** - Electrical Parameters, Physical Construction, Electrical Model, Frequency Response of Transformers, Step-Up/Step-Down Transformers and Circuit Applications, **On-Chip Filters** - Filters Using Bond Wires, Active Filters, On-Wafer Antennas, Wafer-Level Packaging. **System Design Considerations: I/O Counts, Cross-Talk, Digital Circuitry Noise** - IC Floor Plan, Signal

Flow and Substrate Coupling, Grounding, Isolation, **Packaging Considerations** - Package Modeling, Bonding Limitation.

Text Books

1. Joy Laskar, Babak Matinpour, Sudipto Chakraborty, "Modern Receiver Front- Ends Systems, Circuits, and Integration", Wiley- Interscience, 2004.

Reference Books

1. Les Besser, Rowan Gilmore, "Practical RF circuit Design for Modern Wireless Systems", Volume I, Passive Circuits and Systems, Artech House, 2003.
2. Les Besser, Rowan Gilmore, "Practical RF circuit Design for Modern Wireless Systems", Volume II, Active Circuits and Systems, ARTECH House, 2003.
3. Ferril A. Losee, "RF Systems, Components, and Circuits Handbook", Second Edition, ARTECH House, 2004

Course Contents and Lecture Schedule

Module No.	Topic	No.of Lectures
	INTRODUCTION – Current state of art.	1
1	RECEIVER SYSTEM DESIGN	
1.1	Frequency Planning - Blockers, Spurs and Desensing, Transmitter Leakage, LO Leakage and Interference, Image, Half IF	2
1.2	Link Budget Analysis – Linearity, Noise, Signal-to-Noise Ratio, Receiver Gain	2
1.3	Propagation Effects - Path Loss, Multipath and Fading, Equalization, Diversity, Coding	1
1.4	Interface Planning	1
2	REVIEW OF RECEIVER ARCHITECTURES	
2.1	Heterodyne Receivers, Image Reject Receivers - Hartley Architecture, Weaver Architecture	1
2.2	Zero IF Receivers	
2.3	Low IF Receivers	0.5
2.4	Issues in Direct Conversion Receivers – Noise, LO Leakage and Radiation, Phase and Amplitude Imbalance, DC Offset, Intermodulations	1
2.5	Architecture Comparison and Trade-off	0.5
3	SILICON-BASED RECEIVER DESIGN	
3.1	Receiver Architecture and Design - System Description and Calculations, Basics of OFDM, System Architectures, System Calculations	2
3.2	Circuit Design - SiGe BiCMOS Process Technology, LNA, Mixer, Frequency Divider	2
3.3	Receiver Design Steps - Design and Integration of Building Blocks, DC Conditions, Scattering Parameters, Small-Signal Performance, Transient Performance, Noise Performance, Linearity Performance, Parasitic Effects, Process Variation, 50-Ω and Non-50-Ω Receivers, Layout Considerations	2
4	RECEIVER FRONT-END MEASUREMENTS	
4.1	DC Test, Functionality Test, S-Parameter Test, Conversion Gain Test, Linearity Test, Noise Figure Test, I/Q Imbalance, DC Offset	2
4.2	Measurement Results and Discussions - Close Examination of Noise Figure and I/Q Imbalance, Comments on I/Q Imbalance	2
5	RF SYSTEM INTEGRATION	
5.1	System on Package (SoP) - Multilayer Bandpass Filter,	2

	Multilayer Balun Structure, Module-Integrable Antenna, Fully Interated SoP Module	
5.2	On-Chip Inductors - Inductor Modeling, Inductor Parameters, Application in Circuits, Capacitors, Differentially Driven Inductors,	1
5.3	Transformers - Electrical Parameters, Physical Construction, Electrical Model, Frequency Response of Transformers, Step-Up/Step-Down Transformers and Circuit Applications	2
5.4	On-Chip Filters - Filters Using Bond Wires, Active Filters, On-Wafer Antennas, Wafer-Level Packaging.	2
5.5	System Design Considerations - I/O Counts, Cross-Talk	1
5.6	Digital Circuitry Noise - IC Floor Plan, Signal Flow and Substrate Coupling, Grounding, Isolation	2
5.7	Packaging Considerations - Package Modeling, Bonding Limitation	2

Course Designers

Dr.V.Abhaikumar
Dr.A.Thenmozhi

principal@tce.edu
thenmozhi@tce.edu



14ECPV0	PHYSICAL LAYER LTE SYSTEMS	Category	L	T	P	Credit
		PE	2	1	0	3

Preamble

This course aims at designing LTE baseband systems that are used for the design of physical layer LTE systems and its performance. A detailed quantitative framework for LTE baseband system is addressed.

Prerequisite

14EC540 Analog and Digital Communication Systems
14EC620 Wireless Communication Systems

Course Outcomes

On the successful completion of the course, students will be able to

CO1. Describe the FDD and TDD frame formats, physical signals and channels of downlink and uplink LTE systems.	Understand
CO2. Carry out the cell search using synchronization signals in LTE downlink and determine the channel frequency response using reference signals in downlink and uplink of LTE systems.	Apply
CO3. Describe the Multiple antenna transmission and reception techniques for Long Term Evolution standard.	Understand
CO4. Characterize the modulation schemes such as OFDM, OFDMA and SC-FDMA schemes and describe the single user and multi user techniques in LTE downlink and uplink physical layer channel processing systems.	Apply
CO5. Determine the bit error rate and outage probability performances of LTE downlink and uplink channels.	Apply

Mapping with Programme Outcomes

COs	PO 1	PO 2	PO 3	PO 4	PO 5	PO 6	PO 7	PO 8	PO 9	PO 10	PO 11	PO 12	PSO 1	PSO 2	PSO 3
CO1	M	L	-	-	-	-	-	-	L	L	-	L	S	L	L
CO2	S	S	M	L	-	-	-	-	L	L	-	L	S	M	L
CO3	M	L	-	-	-	-	-	-	L	L	-	L	S	L	L
CO4	S	M	L	-	-	-	-	-	L	L	-	L	S	M	L
CO5	S	M	L	-	-	-	-	-	L	L	-	L	S	M	L

S- Strong; M-Medium; L-Low

Assessment Pattern

Bloom's Category	Continuous Assessment Tests			Terminal Examination
	1	2	3	
Remember	20	20	0	0
Understand	20	20	40	40
Apply	60	60	60	60
Analyse	0	0	0	0
Evaluate	0	0	0	0
Create	0	0	0	0

Course Level Assessment Questions

Course Outcome 1 (CO1):

1. Define cyclic delay diversity.
2. Draw the block diagram of LTE downlink channel processing
3. Draw the block diagram of LTE uplink channel processing

Course Outcome 2 (CO2):

1. How the LTE downlink physical channel processing is applied for PHICH channel?
2. Give the FDD Type 1 and TDD Type 2 Frame structures of LTE system. How does the PHICH data are mapped into these frame structures?
3. Consider a PCFICH downlink control channel in LTE. It transmits information about the number of OFDM symbols used by control channels in a subframe. The 32 bit transmitting sequences for each values of CFI are listed in Table 1

CFI	$\langle \mathbf{b}_0, \mathbf{b}_1, \dots, \mathbf{b}_{31} \rangle$
1	$\langle 0,1,1,0,1,1,0,1,1,0,1,1,0,1,1,0,1,1,0,1,1,0,1,1,0,1,1,0,1,1,0,1 \rangle$
2	$\langle 1,0,1,1,0,1,1,0,1,1,0,1,1,0,1,1,0,1,1,0,1,1,0,1,1,0,1,1,0,1,1,0 \rangle$
3	$\langle 1,1,0,1,1,0,1,1,0,1,1,0,1,1,0,1,1,0,1,1,0,1,1,0,1,1,0,1,1,0,1,1 \rangle$
4	$\langle 0,0 \rangle$

Table 1

Assuming that PCFICH uses transmit diversity with two antenna ports, derive expressions for probability of error in detection of the CFI value when

- a. Single antenna port at the UE
- b. Two antenna ports at the UE

Course Outcome 3 (CO3):

1. Give the sampled signal models of SIMO and MISO systems, assuming that the channel is slow and flat frequency fading.
2. Consider a channel matrix of 4 x4 MIMO system. What is the multiplexing gain of each of channel, i.e., how many independent scalar data streams can be supported reliably?

$$H = \begin{bmatrix} -1 & -1 & 1 & 1 \\ -1 & 1 & 1 & -1 \\ -1 & -1 & -1 & -1 \\ -1 & 1 & -1 & 1 \end{bmatrix}$$

3. State true or false : Justify your answer
 - Channel knowledge at the transmitter is not required in MIMO channels to extract multiplexing gain.
 - Channel knowledge at the transmitter is required in MIMO channels to extract diversity gain

Course Outcome 4 (CO4):

1. What is cyclic prefix in OFDM system?
2. It is known that OFDM system converts a frequency selective fading channel into a set of parallel flat fading channel. Justify this statement with the assumption that the data $\tilde{s} = [1, -1, 1, -1]$ is to be transmitted through a frequency selective fading channel $g = [0.5, 0.25]$.
3. Derive expressions for ML estimation of time and frequency offset in OFDM system. The received signal model is given by $r(k) = s(k - \tau) \exp(j2\pi\epsilon k / N) + n(k)$. τ is the integer valued unknown arrival time of OFDM symbol and ϵ is normalized frequency offset. It is assumed that $2N + L$ consecutive samples are observed. N is number of subcarriers in OFDM symbol and L is length of cyclic prefix.

Course Outcome 5 (CO5):

1. Determine the pairwise probability of PCFICH channel assuming that CFI can take values between 1 and 4.

- Determine the bit error rate performance of LTE downlink PUSCH channel.
- Determine the bit error rate performance of LTE uplink PUSCH channel.

Concept Map

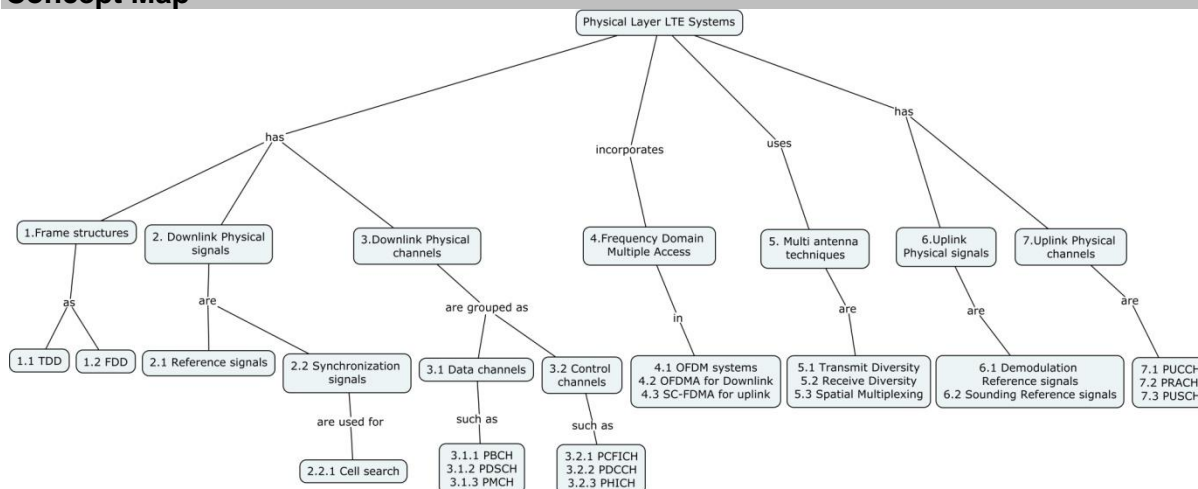

Syllabus

Frame structure: Frequency Division Duplexing, Time Division Duplexing
Downlink Physical signals: Synchronization signals, Cell Search, Reference signals: Frequency Domain, Time domain and Spatial Domain channel estimations, **Downlink Physical channels:** Data channels-PBCH,PDSCH,PMCH, Control channels: PCFICH, PDCCH, PHICH, Downlink channel processing, BER and Outage probability **Frequency Domain Multiple Access:** OFDMA for downlink, SC-FDMA for uplink **Multiple Antenna Techniques:** Single user systems: Space Frequency Block coding, Cyclic Delay Diversity, Spatial Multiplexing, Multi user systems: Space Division Multiple Access(SDMA) using precoding **Uplink Physical signals:** Demodulation Reference signals, channel Estimation, Sounding Reference signals, Channel Quality Determination, **Uplink Physical channels:** PUCCH,PRACH, PUSCH, Uplink channel processing, BER and Outage probability

Text Books

- Erik Dahlman, Stefan Parkvall, Johan Skold, "4G-LTE-LTE-Advanced for Mobile broadband", Elsevier, 2011.
- Rias Muhamed, Jeffrey G. Andrews, Jun Zhang, Arunabha Ghosh, "Fundamentals of LTE", Prentice Hall, 2010.

Reference Books

- Sasson Ahmadi, "LTE-Advanced: A Practical system approach to understand 3GPP LTE releases 10 and 11 Radio access technologies" Elsevier, Fifth Edition, 2014.
- Moray Rumney, "LTE and the evolution to 4G Wireless, Design and Measurement Challenges", John and Wiley Sons Ltd, Second Edition, 2013.
- 3GPP TS 36.211: "Evolved Universal Terrestrial Radio Access (E-UTRA); Physical channels and modulation", 2011
- 3GPP TS 36.212: "Evolved Universal Terrestrial Radio Access (E-UTRA); Multiplexing and channel coding". 2011
- 3GPP TS 36.213: "Evolved Universal Terrestrial Radio Access (E-UTRA); Physical layer procedures". 2011
- Stefania Sesia, Issam Toufik, Matthew Baker, "LTE-The UMTS Long Term Evolution From theory to practice, John Wiley & Sons Ltd., 2009.
- David Tse and Pramod Viswanath, "Fundamentals of Wireless Communications", Cambridge University Press, 2005 (First Asian Edition, 2006)
- Andrea Goldsmith, "Wireless Communications", Cambridge University Press, 2005
- A. Paulraj, R. Nabar and D Gore, "Introduction to Space-Time Wireless Communications", Cambridge University Press, 2003.

Course Contents and Lecture Schedule

Module No.	Topic	No. of Lectures
1	Frame structure	
1.1	Frequency Division Duplexing	1
1.2	Time Division Duplexing	1
2	Downlink Physical signals:	
2.1	Synchronization signals	1
2.1.1	Cell Search	1
2.2	Reference signals	1
2.2.1	Frequency Domain channel estimation	1
2.2.2	Time domain channel estimation	1
2.2.3	Spatial domain channel estimation	1
3	Downlink Physical channels	
3.1	Data channels	1
3.1.1	PBCH – Physical Broadcast Channel	1
3.1.2	PDSCH – Physical Downlink Shared Channel	1
3.1.3	PMCH – Physical Multicast Channel	1
3.2	Control channels	1
3.2.1	PCFICH – Physical Control Format Indicator Channel	1
3.2.2	PDCCH – Physical Downlink Control Channel	1
3.2.3	PHICH – Physical Hybrid ARQ Channel	1
3.3	Downlink channel processing	1
3.4	BER Analysis of Downlink physical Channels	1
3.5	Outage probability Analysis of Downlink Physical Channels	1
4	Frequency Domain Multiple Access	
4.1	OFDMA for downlink	1
4.2	SC-FDMA for uplink	1
5	Multiple Antenna Techniques:	
5.1	Single user systems:	1
5.1.1	Space Frequency Block coding	1
5.1.2	Cyclic Delay Diversity	1
5.1.3	Spatial Multiplexing	1
5.2	Multi user systems:	1
5.2.1	Space Division Multiple Access(SDMA) using precoding	1
6	Uplink Physical signals	
6.1	Demodulation Reference signals	1
6.1.1	channel Estimation	1
6.2	Sounding Reference signals	1
6.2.1	Channel Quality Determination	1
7	Uplink Physical channels:	
7.1	PUCCH – Physical Uplink Control Channel	1
7.2	PRACH – Physical Random Access Channel	1
7.3	PUSCH – Physical Uplink Shared Channel	1
7.4	Uplink channel processing	1
7.5	BER Analysis of Uplink physical Channels	1
7.6	Outage probability Analysis of Uplink Physical Channels	1
	Total	36

Course Designers:

1.	Dr.S.J.Thiruvengadam	sjtece@tce.edu
2.	Dr.G.Ananthi	gananthi@tce.edu

14ECPW0	MIXED SIGNAL INTEGRATED CIRCUITS	Category	L	T	P	Credit
		PE	3	0	0	3

Preamble

This course is to knowledge of link between analog world and digital world as in the name of mixed signal circuit. It is performed by sampling and hold circuit, DAC and ADC. The course mainly presents state-of-the-art Sample and hold circuits, digital-to-analog converters, a range of analog-to-digital converters, and the design of Class D power amplifiers.

Prerequisite

14EC220 - Passive Network Analysis and Synthesis

14EC230- Semiconductor Devices

14EC270 - Digital Logic Circuit Design

14EC330 - Electronic Circuit Design

Course Outcomes

On the successful completion of the course, students will be able to

CO1. Find out the performance parameters of ADC and DAC	Understand
CO2. Observe the design errors in S/H circuit, comparators	Apply
CO3. Design feedback, flash, and over-sampling ADCs	Apply,
CO4. Evaluate the variants of DAC and DAC architecture	Analyze
CO5. Evaluate the efficiency of Class A and D power amplifiers	Analyze

Mapping with Programme Outcomes

COs	PO 1	PO 2	PO 3	PO 4	PO 5	PO 6	PO 7	PO 8	PO 9	PO 10	PO 11	PO 12	PSO 1	PSO 2	PSO 3
CO1	M	L	-	-	-	-	-	L	M	L	-	-	L	-	-
CO2	S	M	L	-	-	-	-	L	M	L	-	-	M	-	-
CO3	S	M	L	-	-	-	-	L	M	L	-	L	M	-	L
CO4	S	M	L	-	-	-	-	L	M	L	-	L	M	-	L
CO5	S	M	L	-	-	-	-	M	L	L	-	L	M	-	L

S- Strong; M-Medium; L-Low

Assessment Pattern

Bloom's Category	Continuous Assessment Tests			Terminal Examination
	1	2	3	
Remember	10	10	10	10
Understand	30	30	30	30
Apply	60	60	60	60
Analyse	0	0	0	0
Evaluate	0	0	0	0
Create	0	0	0	0

Course Level Assessment Questions**Course Outcome 1 (CO1):**

1. What is Post filter and Prefilter in DAC and ADC?
2. Describe, in your own words, what are the difference between specifying SNR and SNDR of a data converter.
3. How will be the SNR ideal by increasing the value of N or the bit resolution of the quantizer?

4. Define offset, linearity errors of an ADC and DAC?
5. Define preamplifier and power amplifier.
6. What is the best input signal for class-E power amplifier?

Course Outcome 2 (CO2):

1. Is it possible to design a S/H with a gain of 0.5? How can this be done or why can't it be done?.
2. How can you decimate and interpolate the samples?
3. What do you do in the circuit to improve SNR?
4. How do you distinguish between efficiency and gain of a power amplifier?
5. Explain how the microphone in your amplifier works. How, exactly, does it convert waves of air pressure (sound) into electrical signals?

Course Outcome 3(CO3):

1. How impulse sampling a sine wave can result in an alias of the sampled sine wave at a different frequency. The Fourier transform of a sinusoid with frequency f_0 looks like

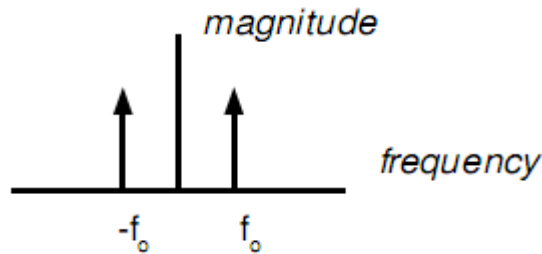

2. Find the transfer function for structure given below.

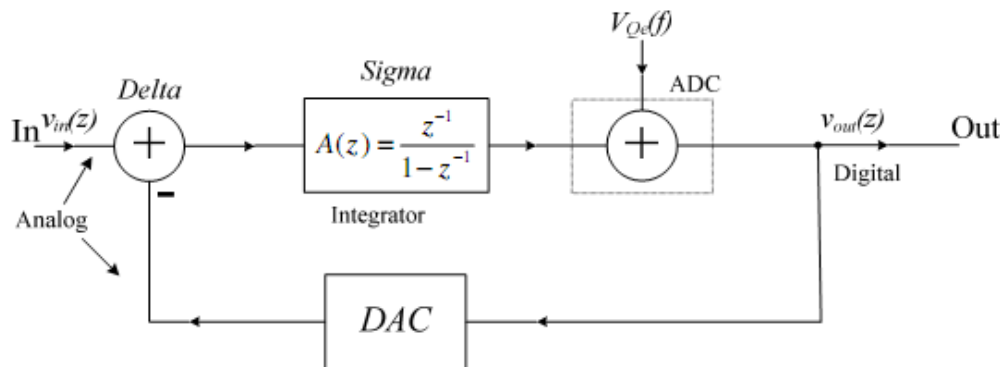

3. While Class A amplifier circuits are simpler to design and build, they are rarely used for high-power applications. Why is this? Why are Class B amplifier designs much more popular for high-power applications? Would it be practical for you to build a microphone amplifier such as this using nothing but Class A circuitry?
4. Explain how you plan to test for and eliminate (if necessary) any crossover distortion from your amplifier circuit. Do you suspect crossover distortion will be more noticeable at low volume levels or high volume levels? Explain why.

Course Outcome 4(CO4):

1. Develop an expression for the effective number of bits in terms of the measured signal-to-noise ratio if the input sine wave has a peak amplitude of 50% of $(V_{REF+} - V_{REF-})$.
2. Design a Digital circuit which will decimate or interpolate the samples.
3. Design a full-differential second-order Noise Shaping modulator.
4. Design a dual slope ADC with 2000 count resolution.

Course Outcome 5(CO5):

1. Design a RF class E power amplifier driving an antenna which is modeled as a load resistor with 50Ω impedance. and the EIRP should $\leq -45\text{dbm}$
2. Design a Class D amplifier to deliver maximum power of 28watts to an 8ohm speaker.
3. How accurate does an 8-bit ADC have to be in order to use a digital filter to average 16 output samples for a final resolution for 10-bits? Assume the ideal LSB of the 8-bit converter is 10mV.
4. Design a switched current source based 4 bit DAC.

Concept Map

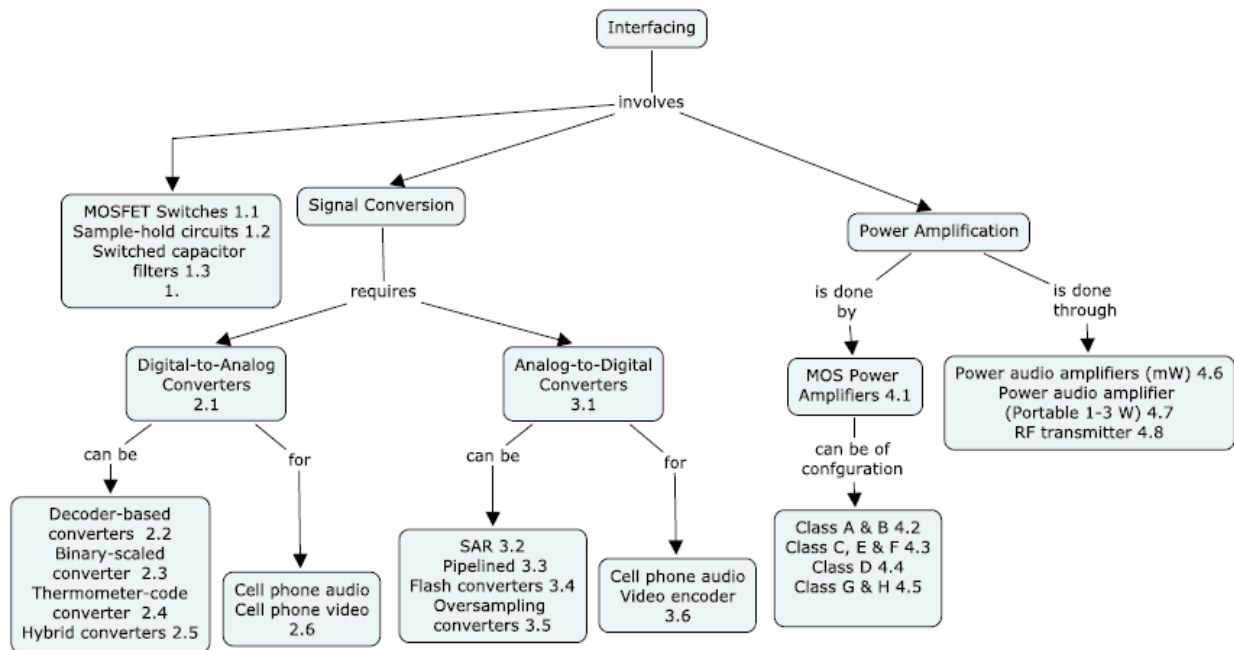

Syllabus

Switching Circuits for Data conversion: MOSFET Switches Comparators, Comparators Sample-hold and Voltage Reference Switched Capacitor Filters

Digital to Analog converter: DAC architecture and characteristics, Decoder-based DACs, Binary Scaled Converters, Thermometer-code Converter, Hybrid Converters.

Analog to Digital converter: ADC architecture and characteristics, Successive Approximation ADC, Pipelined ADC, Flash Converters,

Over-sampling Convertors: Over sampling-first order and second order Sigma delta ADCs, Decimation Filters

Power amplifiers: MOSFET Power Amplifier: Characteristics, MOSFET based Class A, B, AB amplifiers, Class D MOSFET Power Amplifier

Interfacing Data Convertors: Parallel and serial protocols

Text Books

1. David A. Johns and Ken Martin: Analog Integrated Circuit Design, Wiley India, 1997
2. R. Jacop Baker, CMOS Design, layout, simulation. Wiley Interscience, 2nd ed., 2005.
3. R. J Baker, CMOS Mixed signal circuit Design. Wiley Interscience, 2nd ed., 2009.
4. Sundaram Natarajan: Microelectronics Analysis& design, McGraw-Hill 2006.
5. Razavi, Design of Analog CMOS Integrated Circuits. Electrical Engineering, McGraw-Hill International, 2001.
6. Sorin Alexander Huss: Model Engineering in Mixed-Signal Circuit Design, Springer, 2001.

Course content

No.	Topic	No. of Lectures
1	Switching Circuits for Data conversion	8
1.1	MOSFET Switches Comparators	2
1.2	Comparators	2
1.3	Sample-hold and Voltage Reference	2
1.4	Switched Capacitor Filters	2
2.	Nyquist Rate Digital to Analog converter	6
2.1	DAC architecture and Error characteristics	2
2.2	Decoder-based DACs	1
2.3	Binary Scaled Converters	1
2.4	Thermometer-code Converter	1
2.5	Hybrid Converters	1
3	Nyquist Rate Analog to Digital converter	5
3.1	ADC architecture and Error characteristics	2
3.2	Successive Approximation ADC	1
3.3	Pipelined ADC	1
3.4	Flash Converters	1
4	Over sampling Converters	11
4.1	1st order Sigma delta ADCs	2
4.2	Noise shaping for 1st order ADC	2
4.3	2 nd order Sigma delta ADCs	2
4.4	Noise shaping for 2 nd order ADCs	3
4.5	Decimation filter	2
5	Power amplifiers	4
5.1	MOSFET Power Amplifier: Characteristics	1
5.2	MOSFET based Class A, B, AB amplifiers	1
5.3	Class D MOSFET Power Amplifier	2
6	Interfacing Data Converters	2
6.1	Parallel and Serial protocols	2

Course Designers

- | | |
|-----------------------|-------------------------|
| 1. Dr.K. Hariharan | khk@tce.edu |
| 2. Dr.L.R.Karlmarx | lrkarlmarx@tce.edu |
| 3. Mr.S.Parthasarathi | parthasarathi_s@tce.edu |

14ECPY0	ELECTRICAL AND ELECTRONIC MEASUREMENT	Category	L	T	P	Credit
		PE	3	0	0	3

Preamble

This course makes the students to gain knowledge about different types analog and digital measurement techniques of circuit components and electrical quantities. It introduces principle of basic operation of analog and digital measuring instruments for measurement of current, voltage, power, energy and etc. Measurement of resistance, inductance and capacitance by using DC/AC bridge circuits will be discussed in detail. This will also develop the basic knowledge in the areas of several domestic applications of measuring instruments. This Deals with the operating principle of Signal generators and their measurements and learning the basics of frequency. Students will gain insight knowledge on Different types transducers and their usage in the Data Acquisition and its instrumentation

Prerequisite

14EC330 - Electronic Circuit Design

Course Outcomes

On the successful completion of the course, students will be able to

CO1. Identify errors in different types of electrical measurements.	Understand
CO2. Determination of capacitance and inductance measurement Using AC bridges	Analyze
CO3. Explanation of Digital Measurement Concepts.	Apply
CO4. Design of signal generator and their measurements system	Apply
CO5. Design of Sensor for various application.	Apply

Mapping with Programme Outcomes

COs	PO 1	PO 2	PO 3	PO 4	PO 5	PO 6	PO 7	PO 8	PO 9	PO 10	PO 11	PO 12	PSO 1	PSO 2	PSO 3
CO1	M	L	-	-	-	-	-	L	M	L	-	-	L	-	-
CO2	S	M	L	-	-	-	-	L	M	L	-	-	M	-	-
CO3	S	M	L	-	-	-	-	L	M	L	-	L	M	-	L
CO4	S	M	L	-	-	-	-	L	M	L	-	L	M	-	L
CO5	S	M	L	-	-	-	-	M	L	L	-	L	M	-	L

S- Strong; M-Medium; L-Low

Assessment Pattern

Bloom's Category	Continuous Assessment Tests			Terminal Examination
	1	2	3	
Remember	20	20	10	0
Understand	40	40	30	20
Apply	40	40	20	60
Analyse	0	0	20	20
Evaluate	0	0	0	0
Create	0	0	0	0

Course Level Assessment Questions

Course Outcome 1 (CO1):

1. Mention the standards of measurement and errors.
2. Differentiate indicating and integrating instruments.
3. Explain in detail about PMMC.
4. Sketch the equivalent circuit model for the given system
5. Calculate random error, systematic error, gross error for the given MI readings.

Course Outcome 2 (CO2)

1. What is the value of series resistance to be used to extent '0'to 200V range of 20,000 Ω /volt voltmeter to 0 to 2000 volt?
2. Bring out the resistance variations with temperature.
3. Discuss about AC –Bridge to measure capacitance.
4. A 250V M.I. voltmeter has coil resistance of 500 Ω , coil inductance of 1.04 H and series resistance of 2k Ω . The meter reads correctively at 250V D.C. What will be the value of capacitance to be used for shunting the series resistance to make the meter read correctly at 50HZ? What is the reading of voltmeter on A.C. without capacitance?
5. Describe the types of inductance.

Course Outcome 3 (CO3)

1. What is Hysteresis effect?
2. Prove that for electro-dynamometer type wattmeter true power = $\{\cos \Phi / [\cos \Phi \cos (\Phi - \beta)]\}$ x actual wattmeter reading Where $\cos \Phi$ power factor of the circuit $\beta = \tan^{-1} (\omega L/R)$ where L and R are the inductance and resistance of the pressure coil of the circuit.
3. Enumerate about the various testing methods on single phase energy meter.
4. Illustrate the working of Spectrum Analyzer.
5. Describe the measurement of frequency, phase angle and time delay using oscilloscope with suitable diagrams and mathematical expressions.

Course Outcome 4 (CO4)

1. List out the basic components in a function generator.
2. Explain PWM and How it can be generated.
3. Illustrate the working of Basic Schmitt trigger used in Function generator.
4. What is VCO and name some applications in which VCO is used.
5. Describe the Working of PLL and its use in Frequency synthesizer.

Course Outcome 5 (CO5)

1. Analyze the effects of voltmeter calibrated with a potentiometer.
2. Discuss about the steps in selection of transducers and various types of transducers.
3. Design a smart sensor and mention its applications.
4. Bring out the difference between Piezoelectric and Hall effect.
5. Illustrate about Data Acquisition System

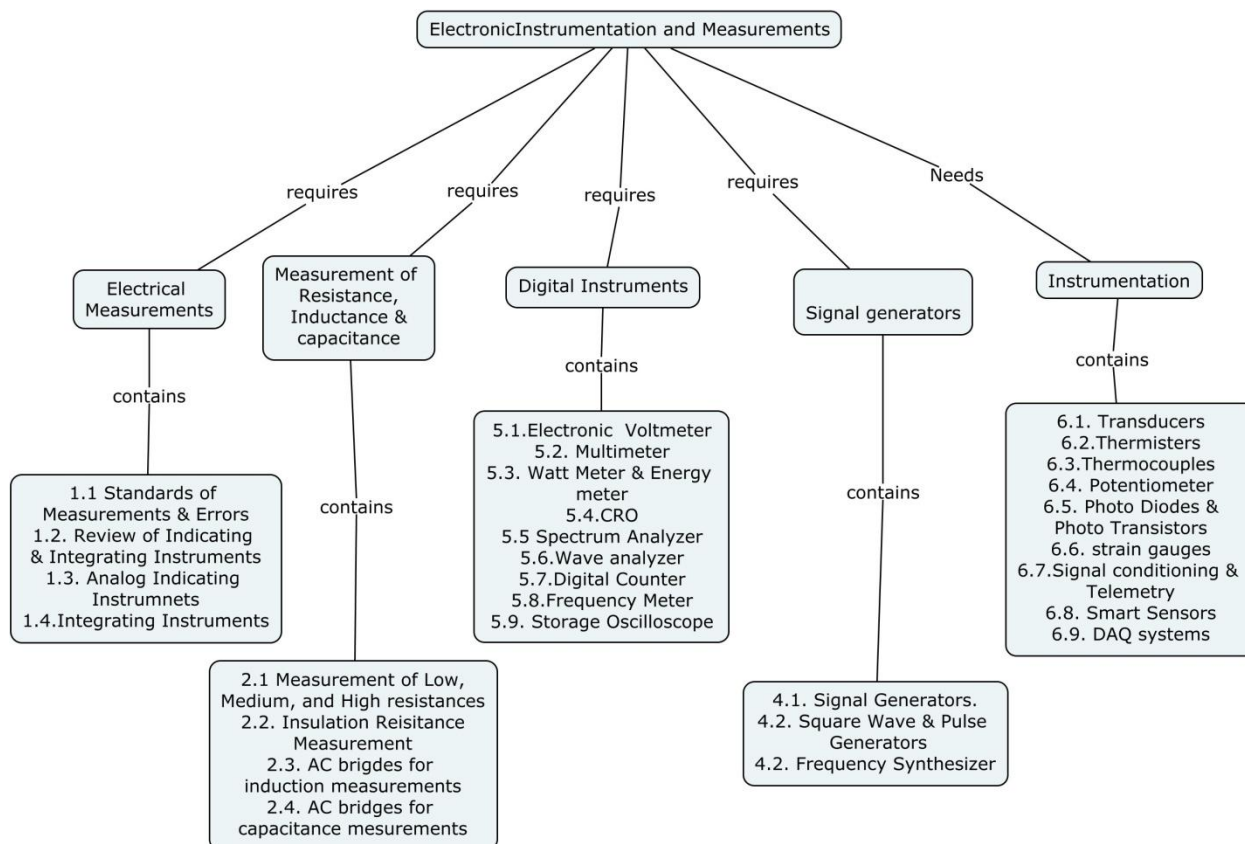
Concept Map**Syllabus**

Electrical Measurements-Standards of Measurement & Errors – Accuracy and precision types Statistical analysis, analog indicating instruments: MC,MI instruments: Voltmeter-Ammeter- Wattmeter- Multimeter and Energy meter.

Measurement of Resistance, Inductance and Capacitance-Measurement of low, medium and high resistances, insulation resistance measurement, AC bridges for inductance and capacitance measurement.

Digital Instruments: Electronic voltmeter- Multimeter- Wattmeter- Energy meter, Time-Frequency- phase angle measurements using CRO, Spectrum analyzer, Digital counter-frequency meter-virtual instruments

Signal generators. Function generators- pulse and square wave generators- Frequency Synthesizer

Transducers: classification & selection of transducers- inductive & capacitive transducers- piezoelectric and Hall-effect transducers- encoder, thermistors, thermocouples, potentiometer, photo-diodes & photo-transistors, strain gauges, signal conditioning and telemetry, basic concepts of smart sensors and application, Data Acquisition Systems. Interfacing of transducers, Multiplexing, Data loggers, Computer controlled Instrumentation

Text Books

1. Albert D.Helfrick and William D.Cooper –Modern Electronic Instrumentation and Measurement Techniques, Pearson / Prentice Hall of India, 2016.
2. Ernest O. Doebelin, Measurement Systems-Application and Design, TMH,2007.

Reference Books

1. Jones, B.E., "Instrumentation Measurement and Feedback", Tata McGraw-Hill, 1986.
2. Golding, E.W., "Electrical Measurement and Measuring Instruments", 3rd Edition, Sirlsac Pitman and Sons, 1960.
3. Buckingham, H. and Price, E.N., "Principles of Electrical Measurements", 1961.
4. A.K.Sawhney, "A Course in Electrical and Electronic Measurements and Instrumentation (Nineteenth Revised Edition 2011 Reprint 2014), Dhanpat rai & co.

Course Contents and Lecture Schedule

Module No.	Topic	No. of Lectures
1	Electrical Measurements	8
1.1	Standards of Measurement & Errors	1
1.2	Review of indicating and integrating instruments	1
1.3	Integrating instruments	1
1.3.1	Voltmeter, Ammeter, Multimeter	1
1.3.2	Wattmeter, Energy meter	1
1.4.1	PMMC meter	1
1.4.2	MI meter & ED meter	2
2	Measurement of R,L&C	5
2.1	Measurement of low, high resistances and insulation	1
2.2	Measurement of capacitance – AC bridges	2
2.3	Measurement of Inductance – AC bridges	2
3	Digital instruments	10
3.1	Electronic voltmeter & Ammeter	1
3.2	Electronic multimeter	2
3.3	Electronic wattmeter and energy meter	1
3.4	Digital counter	1
3.5	Frequency meter	1
3.6	Digital LCR meter	1
3.7	CRO and DSO	2
3.8	Spectrum analyzer	1
4	Signal Generators	5
4.1	Function generators	1
4.2	Pulse and Square wave generators & frequency synthesizer	2
4.3	Frequency synthesizer	2
5	Transducers	12
5.1	Classification & selection of transducers	1
5.2	Inductive & capacitive transducers	1
5.3	Piezoelectric and Hall-effect transducers	1
5.4	Encoder Thermistors, Thermocouples	1
5.5	Potentiometer, Photo-diodes & photo-transistors	1
5.6	Strain gauges, Signal conditioning and telemetry	1
5.7	Data Acquisition Systems	2
5.8	Interfacing of Transducers	2
5.9	Multiplexers, Data loggers	2
	Total Number of Hours	40

Course Designer:

- | | |
|-----------------------|--|
| 1. Dr.K.Hariharan | khh@tce.edu |
| 2. Dr. L.R. Karl Marx | lrkarlmarx@tce.edu |
| 3. Mr.S.Parthasarathi | parthasarathi_s@tce.edu |

14ECPZ0	SPEECH PROCESSING	Category	L	T	P	Credit
		PE	2	1	0	3

Preamble

This course highlights the central role of DSP techniques in modern speech communication research and applications. The course presents a comprehensive overview of digital speech processing that ranges from the basic nature of the speech signal, through a variety of methods of representing speech in digital form, to applications in voice communication and automatic synthesis and recognition of speech.

Prerequisite

14EC440 Signal Processing

Course Outcomes

On the successful completion of the course, students will be able to

CO1. Describe the process of speech production system and auditory perception system.	Understand
CO2. Analyze the speech signal using deterministic and stochastic process models.	Analyze
CO3. Determine the linear prediction coefficients for the speech samples. and	Apply
CO4. Design a scalar and vector quantizer to be used in the coding of speech and develop a scalar quantizer for linear prediction coefficients	Apply
CO5. Develop linear predictive coding algorithm for speech signal.	Apply
CO6. Develop code excited linear predictive coder for speech signal and analyze its components	Analyze

Mapping with Programme Outcomes

COs	PO	PO	PO	PO	PO	PO	PO	PO	PO	PO	PO	PO	PSO	PSO	PSO
	1	2	3	4	5	6	7	8	9	10	11	12	1	2	3
CO1	M	L	-	-	-	-	-	-	L	L	-	-	S	L	L
CO2	S	S	M	L	-	-	-	-	L	L	-	-	S	L	L
CO3	S	M	L	-	-	-	-	-	L	L	-	L	S	L	L
CO4	S	M	L	-	-	-	-	-	L	L	-	L	S	M	L
CO5	S	M	L	-	-	-	-	-	L	L	-	L	S	M	L
CO6	S	M	L	-	-	-	-	-	L	L	-	L	S	M	L

S- Strong; M-Medium; L-Low

Assessment Pattern

Bloom's Category	Continuous Assessment Tests			Terminal Examination
	1	2	3	
Remember	20	10	10	0
Understand	20	30	20	20
Apply	50	50	60	60
Analyse	10	10	10	20
Evaluate	0	0	0	0
Create	0	0	0	0

Course Level Assessment Questions**Course Outcome 1 (CO1):**

- 1 Explain the process of speech generation.
- 2 Explain the human auditory process.

- 3 What are voiced and unvoiced sounds?
- 4 Explain the AR modelling of speech generation process.

Course Outcome 2 (CO2):

1. Given the samples $x[0], x[1], \dots, x[N-1]$ and assuming that they are sorted in ascending order of magnitude $x[0] \leq x[1] \leq \dots \leq x[N-1]$, then the sample median \bar{x} of these numbers is defined by

$$\bar{x} = \begin{cases} x[(N+1)/2], & N \text{ odd} \\ (x[N/2] + x[N/2 + 1])/2, & N \text{ even} \end{cases}$$

Median filtering can be applied as an alternative to eliminate multiples of a pitch period.

- (a) Obtain a sequence of pitch period values by analyzing a speech signal given by $x(n) = \{0, 0.1, 0.2, 0.3, 0.4, 0.1, 0.2, 0.3, 0.4, 0.1, 0.2, 0.3, 0.4\}$ with the autocorrelation method. Apply the median filter and compare the input-output values; change the number of samples under consideration by the median filter and record its effects.
 - (b) Discuss the advantages/disadvantages of the method when compared to the autocorrelation approach.
2. Given the second order filter with $a_1 = -0.9, a_2 = 0.6$,
 - (a) Find the reflection coefficients.
 - (b) Find the difference equations corresponding to direct form and lattice form realizations for both the all-pole and all-zero configurations.
 - (c) Via a substitution/elimination process, manipulate the lattice equations into one single equation relating the output to the input. Show at the end that direct form and lattice form produce the exact same output.
 3. Given the Mth order all-pole filter, find out the computational complexity associated with direct form realization and lattice realization. The answer should be expressed as the number of additions and multiplications per output sample. Which realization is more efficient? Repeat for an all-zero filter.

Course Outcome 3 (CO3):

- 1 Consider the ARMA process generated by the difference equation

$$x(n) = 1.6x(n-1) - 0.63x(n-2) + w(n) + 0.9w(n-1)$$
 - (a) Determine the system function of the whitening filter and its poles and zeros.
 - (b) Determine the power density spectrum of $\{x(n)\}$.
 - (c) Determine the linear predictor coefficient using Levinson Durbin Algorithm.
- 2 Determine the impulse response of the FIR filter that is described by the lattice coefficients $K_1 = 0.6, K_2 = 0.3, K_3 = 0.5, K_4 = 0.9$.
- 3 An AR(3) process $\{x(n)\}$ is characterized by the autocorrelation sequence

$$Y_{xx}(0) = 1, Y_{xx}(1) = \frac{1}{2}, Y_{xx}(2) = \frac{1}{8}, \text{ and } Y_{xx}(3) = \frac{1}{64}$$
 - (a) Use the Schur algorithm to determine the three reflection coefficients K_1, K_2 and K_3 .
 - (b) Sketch the lattice filter for synthesizing $\{x(n)\}$ from a white noise excitation.

Course Outcome 4 (CO4):

- 1 Given a signal source x such that $-1 \leq x \leq 3$, design a uniform quantizer with $N=7$ by specifying all input boundaries and output levels.
- 2 Design the tree structure for a quantizer of size $N=7$. Assuming that the input variable has an equal probability of falling within any particular cell, what is the average number of comparison operations? Repeat for $N=6$.
- 3 We are given the following configurations of vector quantizers, all having the same resolution of 10 bits:

$$\begin{array}{ll} \text{Unconstrained VQ} & r = 10 \\ \text{Two-stage MSVQ} & (r_1, r_2) = (3, 7) \end{array}$$

Two-stage MSVQ	$(r_1, r_2) = (5, 5)$
Three-stage MSVQ	$(r_1, r_2, r_3) = (2, 2, 6)$
Three-stage MSVQ	$(r_1, r_2, r_3) = (3, 3, 4)$
Four-stage MSVQ	$(r_1, r_2, r_3, r_4) = (1, 1, 1, 7)$
Four-stage MSVQ	$(r_1, r_2, r_3, r_4) = (2, 2, 3, 3)$

Calculate the memory cost for each configuration. Sort the vector quantizers in terms of relative performance under a full search. Explain your results.

Course Outcome 5 (CO5):

- 1 A 130-sample block is selected for pitch-synchronous LP analysis within each 180-sample voiced frame, specified with $n \in [0, 179]$. The 130-sample block is indicated with a starting position $n_o \in [-20, 50]$; that is, the interval on which LP analysis is performed is given by $n \in [n_o, n_o + 129]$. The starting position is generally found in such a way that consecutive frames rely on approximately the same cycle of the waveform to perform LP analysis. In this way, synchronization is maintained. Design an algorithm to determine n_o based on peak location. Propose alternative realizations to boost robustness.
- 2 The first reflection coefficient is included in the enhanced version of the FS1015 coder for voicing detection. The parameter reflects the spectral tilt of the speech waveform. Voiced frames typically have a significant tilt of decreasing magnitude with increasing frequency. Using some speech signal, obtain the first reflection coefficient by LP analyzing on a frame-by-frame basis. What conclusion can be obtained for the first reflection coefficient and voicing state?
- 3 Many speech coding algorithms rely on interpolation to ensure a smooth transition between frames during decoding. That is, the actual parameters used for decoding are obtained through interpolation of two sets of parameters: past and present frames. For the case of the LPC coder, the parameters are pitch period, voicing, power, and LPC. Which of these parameters are not suitable for interpolation? Propose some interpolation schemes that would work reasonably well for signal decoding.

Course Outcome 6 (CO6):

1. Consider the analysis-by-synthesis loop described in the following figures. We are given the parameters: L: Size of excitation codebook, N1: Number of operations required by the pitch synthesis filter per excitation code vector, N2: Number of operations required by the (modified) formant synthesis filter per excitation code vector, N3: Number of operations required by the perceptual weighting filter per excitation code vector. Further assume that the number of operations required by other components of the loop is negligible. Compare the total number of operations needed to perform one complete codebook search (i.e., L passes through the loop). Which scheme is more efficient?

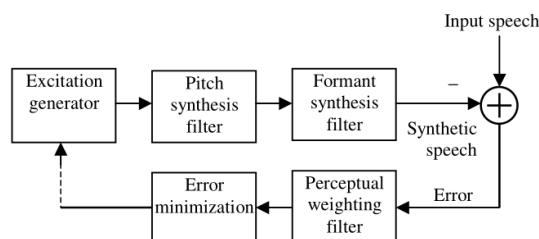

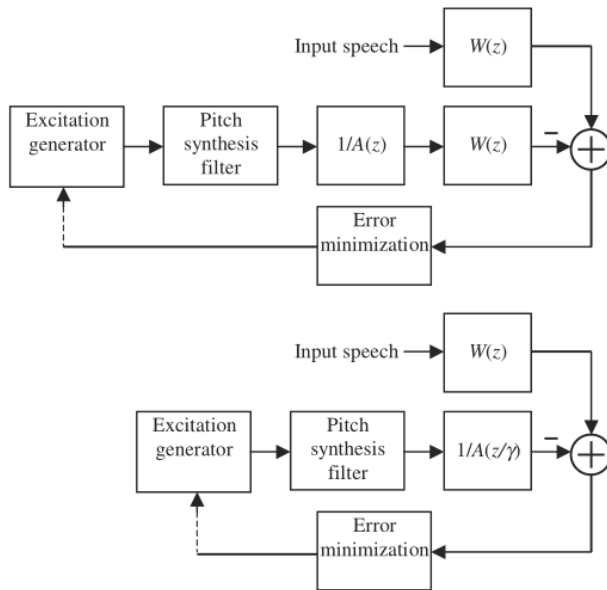

- Plot the number of products per excitation codebook search for the state-save method and the zero-input zero-state method, with $M=10$, $N=60$, and $T= 50$, as a function of L , where L ranges from 8 to 1024 (3 to 10 bits codebook). For what range of L is the zero-input zero-state method more efficient? Repeat for $T= 80$.
- Write down the difference equations relating the signals in an alternative zero input state method shown in figure. Calculate the numbers of sums and products. Is this approach more efficient? If so, explain.

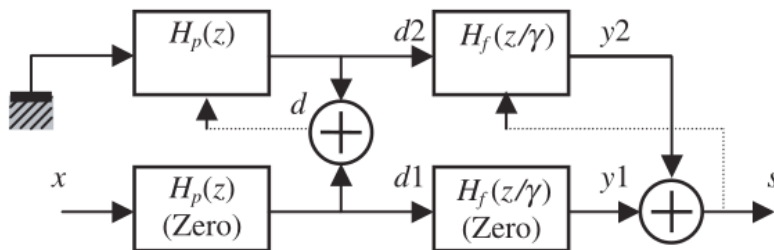

Concept Map

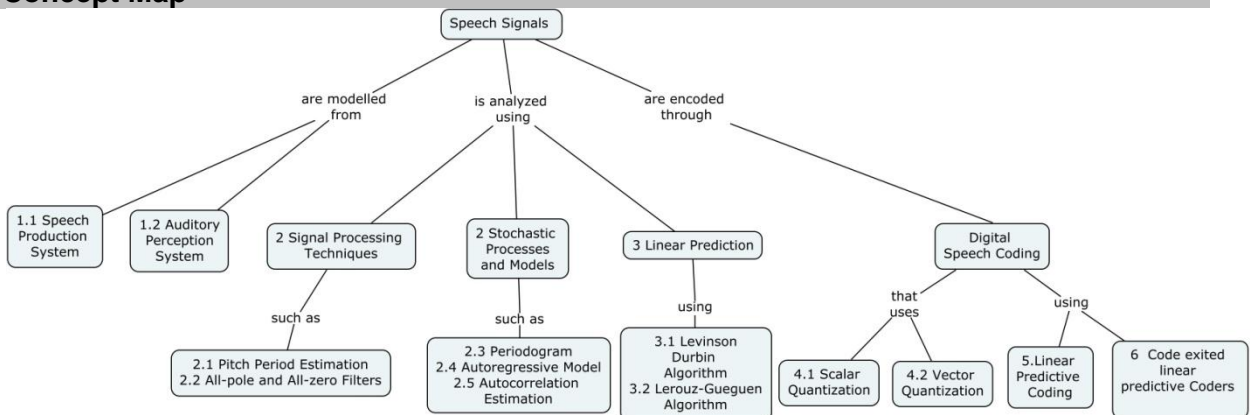

Syllabus

Speech Production and Auditory Perception: Speech Production and Modelling- Origin Classification, Modelling the Speech Production System, Human Auditory System- Structure, Absolute Threshold, Masking and Phase Perception.

Speech Analysis: Pitch Period Estimation, All-Pole and All-Zero Filters, Stochastic Processes and Models- Periodogram, Autoregressive Model, Autocorrelation Estimation

Linear Prediction: The Problem of Linear Prediction, The Levinson Durbin Algorithm, The Leroux–Gueguen Algorithm, Long-Term Linear Prediction, Synthesis Filters.

Quantization: Scalar Quantization, Vector Quantization, Scalar Quantization of Linear Prediction coefficients

Linear Predictive Coding: Speech Production Model, LPC encoder, LPC decoder, Voicing Detector, The FS1015 LPC Coder, Limitations of LPC model.

Code Excited Linear Prediction (CELP): The CELP Speech Production model, The Principle of Analysis-by-Synthesis, Encoding and Decoding, Excitation Codebook Search, Postfilter.

Text Book

1. Wai C. Chu, "Speech Coding Algorithms - Foundation and Evolution of Standardized Coders" John Wiley & Sons, 2003.

Reference Books

1. L. R. Rabiner and R. W. Schafer, "Introduction to Digital Speech Processing", now Publishers Inc., 2007
2. J. L. Flanagan, "Speech Analysis, Synthesis and Perception". Springer-Verlag, 1972
3. L. R. Rabiner and B. H. Juang, "Fundamentals of Speech Recognition". Prentice-Hall Inc., 1993.
4. J. H. Schroeter, "Basic principles of speech synthesis," Springer Handbook of Speech Processing, Springer- Verlag, 2006.

Course Contents and Lecture Schedule

No.	Topic	No. of Lectures
1	Speech Production and Auditory Perception	
1.1	Introduction	3
1.2	Speech Production and Modelling, Origin of Speech Signals, Classification of Speech Signals	1
1.3	Modelling the Speech Production System, Parametric Speech Coding	1
1.4	Human Auditory System, Structure of the Human Auditory System, Absolute Threshold, Masking and Phase Perception	1
2	Speech Analysis	
2.1	Pitch Period Estimation	1
2.2	All-Pole and All-Zero Filters, Convolution	1
2.3	Stochastic Processes and Models, Periodogram	1
2.4	Autoregressive Model, Autocorrelation Estimation, and Other Signal Models.	1
3	Linear Prediction	
3.1	The Problem of Linear Prediction, Linear Prediction Analysis of Nonstationary Signals	1
3.2	Examples of Linear Prediction Analysis of Speech	1
3.3	The Levinson Durbin Algorithm	2
3.4	The Leroux–Gueguen Algorithm.	1
3.5	Long-Term Linear Prediction, Synthesis Filters	1

4	Quantization	
4.1	Scalar Quantization	
4.1.1	Uniform Quantizer	1
4.1.2	Scalar Optimal Quantizer	1
4.2	Vector Quantization,	
4.2.1	Quantizer Design Algorithms	2
4.2.2	Multistage VQ	1
4.2.3	Predictive VQ	1
4.3	Scalar Quantization of linear prediction coefficients	2
5	Linear Predictive Coding	
5.1	Spectral Distortion, Quantization Based on Reflection Coefficient and Log Area Ratio	2
5.2	Line Spectral Frequency	1
5.3	Quantization Based on Line Spectral Frequency	1
5.4	Speech Production Model, Structure of the Algorithm and Voicing Detector	1
6.	Code Excited Linear Prediction	
6.1	The Celp Speech Production Model	1
6.2	The Principle of Analysis-by-Synthesis	2
6.3	Encoding and Decoding	2
6.4	Excitation Codebook Search	2
6.5	Postfilter	1

Course Designers:

1.	Dr.S.J.Thiruvengadam	sjtece@tce.edu
2.	Dr.M.N.Suresh	mnsece@tce.edu
3.	Dr.K.Rajeshwari	rajeswari@tce.edu

14ECRA0	AUDIO SIGNAL PROCESSING	Category	L	T	P	Credit
		PE	2	0	1	3

Preamble

The course "Digital Audio Signal Processing" is offered as an elective subject in continuation with core subject 14EC440 Signal processing and elective subject 14ECPA0 DSP Architecture and Programming. This course provides solutions to problems in audio signal processing like in the field of studio engineering, consumer electronics and multimedia.

Prerequisite

14EC440: Signal Processing

14ECPA0: DSP Architecture and Programming

Course Outcomes

On the successful completion of the course, students will be able to

CO1. Describe the applications of digital audio signal processing	Remember
CO2. Design and implement sampling rate convertors	Apply
CO3. Design and implement recursive, nonrecursive audio filters, and multicomplementary filter bank	Apply
CO4. Model the room impulse response and implement room simulation algorithms.	Apply
CO5. Design and implement dynamic range control algorithms	Apply
CO6. Implement audio coding algorithms in DSP processor	Apply

Mapping with Programme Outcomes

COs	PO 1	PO 2	PO 3	PO 4	PO 5	PO 6	PO 7	PO 8	PO 9	PO 10	PO 11	PO 12	PSO 1	PSO 2	PSO 3
CO1	M	L	-	-	-	-	-	-	M	M	-	-	S	L	L
CO2	S	M	L	-	S	-	-	-	M	M	-	-	S	L	L
CO3	S	M	L	-	S	-	-	-	M	M	-	L	S	L	L
CO4	S	M	L	-	S	-	-	-	M	M	-	L	S	M	L
CO5	S	M	L	-	S	-	-	-	M	M	-	L	S	M	L
CO6	S	M	L	-	S	-	-	-	M	M	-	L	S	M	L

S- Strong; M-Medium; L-Low

Assessment Pattern

Bloom's Category	Continuous Assessment Tests			Terminal Examination
	1	2	3	
Remember	10	10	Practical	10
Understand	30	30		30
Apply	60	60		60
Analyse	0	0		0
Evaluate	0	0		0
Create	0	0		0

Course Level Assessment Questions**Course Outcome 1(CO1):**

8. List the applications of digital audio signal processing.
9. Define digital crossover.
10. Name the audio codec standard to be used in entertainment applications.

Course Outcome 2 (CO2):

4. Consider a simple sampling rate conversion system with a conversion rate of $\frac{4}{3}$. The system consists of two upsampling blocks, each by 2, and one downsampling block by 3. What are anti-imaging and anti-aliasing filters and where do we need them in our system? Sketch the block diagram. Sketch the input, intermediate and output spectra in the frequency domain.
5. Design one-stage and two-stage interpolators to meet the following specification:
 - $L=20$
 - Input sampling rate: 10,000Hz
 - Passband: $0 \leq F \leq 90$
 - Transition band: $90 \leq F \leq 100$
 - Ripple: $\delta_1 = 10^{-2}$ and $\delta_2 = 10^{-3}$
6. Design a two-stage decimator for the following specifications
 - $D=100$
 - Passband: $0 \leq F \leq 50$
 - Transition band: $50 \leq F \leq 55$
 - Input sampling rate: 10,000 Hz
 - Ripple: $\delta_1 = 10^{-1}$, $\delta_2 = 10^{-3}$

Course Outcome 3 (CO3):

7. How can we derive a high frequency shelving filter? Which parameters define the filter?
8. Derive the digital transfer function?
9. Derive a signal flow graph for first and second order parametric Zolzer filter with a direct form implementation of the all pass filters.

Course Outcome 4 (CO4)

4. How does the length of the room impulse response affect the length of the test signal?
5. Based on the Schroeder algorithm, draw a signal flow graph for a comb filter consisting of a single delay line of M samples with a feedback loop containing an attenuation factor g. Derive the transfer function of the comb filter. Calculate the reverberation time of the comb filter for $f_s = 44.1\text{kHz}$, $M = 8$ and g specified previously.
6. Realize an all-pass structure as suggested by Schroeder.

Course Outcome 5 (CO5):

7. Generally, envelope computation is performed by low-pass filtering the input signal's absolute value or its square.
 1. Sketch the block diagram of a recursive first-order low-pass $H(z) = \frac{\lambda}{[1 - (1 - \lambda)z^{-1}]}$. Sketch its step response.
8. Sketch the characteristic curves mapping input level to output level and input level to gain for and describe briefly the application of limiter, compressor, expander and noise gate.
9. Taking absolute value or squaring are non-linear operations. Therefore, care must be taken when using them in discrete-time systems as they introduce harmonics the frequency of which may violate the Nyquist bound. This can lead to unexpected results, as a simple example illustrates. Consider the input signal $x[n] = \sin\left(\frac{\pi}{2}n + \varphi\right)$, $\varphi \in [0, 2\pi]$. Sketch $x[n]$, $|x[n]|$ and $|x^2[n]|$ for different values of φ

Course Outcome 6 (CO6):

7. Human hearing
 - (a) What is the frequency range of human sound perception?
 - (b) What is the frequency range of speech?
 - (c) In the above specified range where is the human hearing most sensitive?
 - (d) Explain how the absolute threshold of hearing has been obtained.
8. Explain the lossless coder and decoder.
9. Consider a_i and f_i to be respectively the amplitude and the frequency of a partial at index i and $V(a_i)$ to be the corresponding volume in dB. The difference between the level of the masker and the masking threshold is -10 dB. The masking curves toward lower and higher frequencies are described respectively by a left slope (27 dB/Bark) and a right slope (15 dB/Bark). Explain the main steps of frequency masking in this case and show with plots how this masking phenomena is achieved.

Concept Map

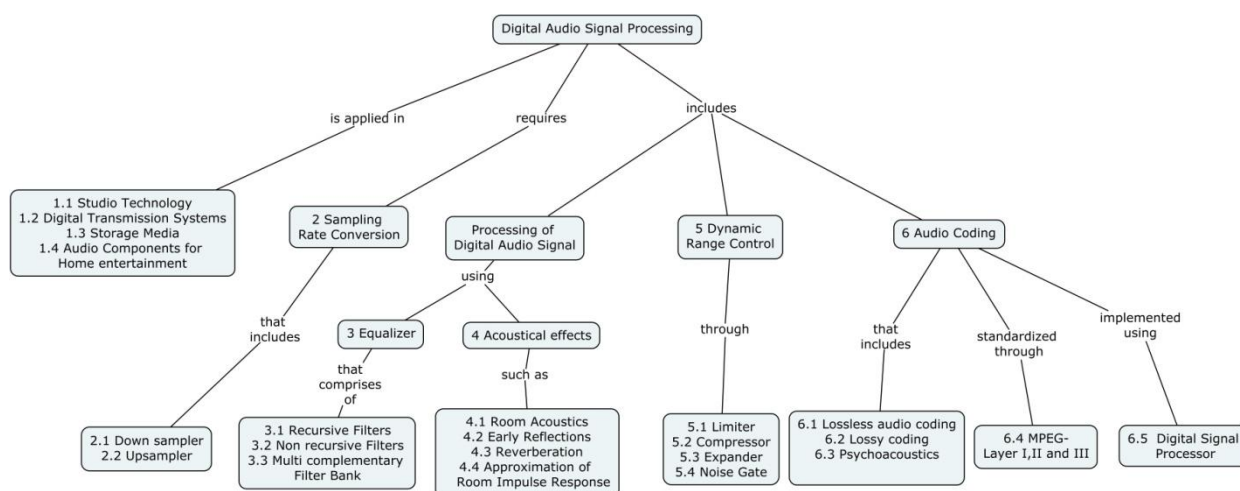

Syllabus

Introduction: Studio Technology, Digital Transmission Systems, Storage Media, Audio Components for Home Entertainment

Sampling Rate Conversion: Down Sampler, Up Sampler.

Digital Audio Signal Equalizer: Recursive Filters, Non Recursive Filters, Multi Complementary Filter Bank.

Acoustic effects: Room Acoustics, Early Reflections, Reverberation, Approximation of Room Impulse Response.

Dynamic Range Control: Static Curve, Dynamic Behaviour, Limiter, Compressor, Expander, Noise Gate, Combination System, Realization Aspects.

Audio Coding: Lossless Audio Coding, Lossy Audio Coding, Psychoacoustics, MPEG-Layer I, II and III.

List of Laboratory Experiments

8. Quantization of speech signal using Blackfin processor
9. For a given sound (voice sound) calculate the delay time of a single first reflection. Write a program for the following computations.
 - a. How do we choose this delay time? What coefficient should be used for it?
 - b. Write an algorithm which performs the convolution of the input mono signal with two impulse responses which simulate a reflection to the left output and a second reflection to the right output. Check the results by listening to the output sound.
10. Write a program that implements Schroeder's reverberator

11. Design and implement quadrature mirror filter.
12. Design and implement volume control of an audio input signals.
13. Design and implement wavelet transformation of the given audio signal.

Text Books

1. UdoZolzer "Digital Audio Signal Processing", Wiley, Second Edition, 2008.
2. Woon-Seng Gan, Sen.M.Kuo, Embedded Signal Processing with Micro Signal Architecture, John Wiley Sons, 2007

Reference Books:

24. Ken.C.Pohlmann, "Principles of Digital Audio", McGraw-Hill, Sixth edition, 2011.
25. Andreas Spanias, Ted Painter, Venkatraman Atti, "Audio Signal Processing and Coding", Wiley, 2007.

Course Content and Lecture Schedule

No.	Topic	No. of Lectures
1	Introduction	
1.1	Studio Technology	1
1.2	Digital Transmission Systems	1
1.3	Storage Media	1
1.4	Audio Components for Home Entertainment	1
2	Sampling Rate Conversion	
2.1	Down Sampler	1
2.2	Up Sampler	1
3	Digital Audio Signal Equalizer	
3.1	Recursive Filters	1
3.2	Non Recursive Filters	1
3.3	Multi Complementary Filter Bank	1
4	Acoustic Effects	
4.1	Room Acoustics	1
4.2	Early Reflections	1
4.3	Reverberation	1
4.4	Approximation of Room Impulse Response	1
5	Dynamic Range Control	
5.1	Static Curve, Dynamic Behaviour	1
5.2	Limiter	1
5.3	Compressor	1
5.4	Expander	1
5.5	Noise Gate, Combination System	1
5.6	Realization Aspects	1
6	Audio Coding	
6.1	Lossless Audio Coding	1
6.2	Lossy Audio Coding	1
6.3	Psychoacoustics	1
6.4	MPEG – Layer I, II and III	2
	Total	24

Course Designers:

1	Dr.S.J.Thiruvengadam	sitece@tce.edu
2	Dr.K.Rajeswari	krajeswari@tce.edu
3	Dr.P.G.S.Velmurugan	pqsvs@tce.edu

14ECRB0	COMPUTER VISION AND APPLICATIONS	Category	L	T	P	Credit
		PE	3	0	0	3

Preamble

This course focuses on how computer treats vision as a process to understand human visual world. It deals with the construction of explicit meaningful descriptions of physical objects or other observable phenomena from images and how they are visualized by a computer and its applications. In lower level, this course deals feature detection techniques such as interest points, Harris corner and SIFT. Subsequently, it describes that how the feature points are matched and the alignment of matched feature points. In mid level, it deals various segmentation algorithms such as thresholding, connected component, contour detection and motion segmentation. Further, it discusses grouping algorithms which comprises of clustering and Graph cut to obtain meaningful segments. The higher-level vision encompasses object recognition which includes object modelling, scene understanding and shape recognition. Finally, it explores applications such as face recognition, scene understanding, activity recognition and augmented reality.

Prerequisite

14EC570 Image Processing

Course Outcomes

On the successful completion of the course, students will be able to

CO1.	Understand how to relate world coordinates and image coordinates.	Understand
CO2.	Apply various feature detection methods and matching such features by measuring the similarity of two regions and understand that how to recover transformation parameters based on matched points for alignment.	Apply
CO3.	Apply numerous segmentation algorithms such as thresholding, contour, region, motion and find the correlation between them for grouping to obtain meaningful segments.	Apply
CO4.	Apply low and mid level methods for object recognition by modelling an object based on shape and scene understanding.	Apply
CO5.	Apply the low, mid and high level methods for various applications like face recognition, scene understanding, action recognition and augmented reality.	Apply

Mapping with Programme Outcomes

COs	PO 1	PO 2	PO 3	PO 4	PO 5	PO 6	PO 7	PO 8	PO 9	PO 10	PO 11	PO 12	PSO 1	PSO 2	PSO 3
CO1	M	L	-	-	L	-	-	-	L	-	-	-	L	M	-
CO2	S	M	L	L	M	-	-	-	M	-	-	-	M	M	-
CO3	S	M	L	L	M	-	-	-	M	L	-	-	M	M	-
CO4	S	M	L	L	L	-	-	-	M	-	-	-	M	M	-
CO5	S	S	M	L	M	M	L	M	M	M	-	L	S	S	L

S- Strong; M-Medium; L-Low

Assessment Pattern

Bloom's Category	Continuous Assessment Tests			Terminal Examination
	1	2	3	
Remember	10	10	10	10
Understand	30	30	10	10
Apply	60	60	80	80

Analyse	0	0	0	0
Evaluate	0	0	0	0
Create	0	0	0	0

Course Level Assessment Questions

Course Outcome 1 (CO1):

- Under what conditions will a line viewed with a pinhole camera have its vanishing point at infinity? Using the same camera model specialized for this particular scenario, write a general formula that describes the relationship between world coordinates (x) , specifying the height of the table top, and image coordinates (u, v) , specifying the pixel coordinates where the point of light is detected. Give your answer using homogeneous coordinates and a projection matrix containing variables.
- A cube has vertices in world coordinates: $(0,0,0)$, $(1,0,0)$, $(1,1,0)$, $(0,1,0)$, $(0,0,1)$, $(1,0,1)$, $(1,1,1)$, $(0,1,1)$. Generate an image of a wireframe model of the cube as if were seen by the camera, similar to the figure below. Assume a pinhole camera model, with focal length = 600 pixels, where the image size is 640 pixels wide by 480 pixels high.
- Hint: The first two vertices of the cube, the ones with world coordinates $(X,Y,Z) = (0,0,0)$ and $(1,0,0)$, project to pixel locations $(x,y) = (252, 240)$ and $(301,255)$, rounded to the nearest pixel.
- The pose of an object (or model) with respect to the world is given by

$$H_{m_w} = \begin{bmatrix} 0.9254 & 0.0180 & 0.3785 & 0.5000 \\ 0.1632 & 0.8826 & -0.4410 & -0.5000 \\ -0.3420 & 0.4698 & 0.8138 & 5.0000 \\ 0 & 0 & 0 & 1.0000 \end{bmatrix}$$

A camera has pose with respect to the world:—Orientation of the camera is aligned with the world. The origin of the camera is at world point = $[0;0;-2]$.

Draw (in 3D) the coordinate axes of the world, the camera, and the model.

Course Outcome 2 (CO2):

- Describe how the *RANSAC algorithm* could be used to detect the orientation of the plane in the scene from the scene points.
- Develop an algorithm to stitch two sample images of the mural in the geology museum which are taken by moving a handheld camera in a freeform motion. Use SIFT features and propose solution for matching and alignment.
- Illustrate various matching strategies and error rates. Compare the results by fixing the false positive rates.
- Develop an algorithm using Harris corner detection and describe one feature alignment technique for the two matched points captured in our TCE Dome.

Course Outcome 3 (CO3):

- Prove that, in the absence of external forces, a snake will always shrink to a small circle and eventually a single point, regardless of whether first- or second order smoothness (or some combination) is used. Also, illustrate how active contour models are used for object detection as a geodesic computation approach.
- Describe region based
- Develop an algorithm to group the scattered nodules in a mammogram image using K-means clustering algorithm.
- Illustrate Graph cut algorithm to segment moving object from the static background.

Course Outcome 4 (CO4):

- How do we identify the important similarities of objects within a category?
- Develop an algorithm to recognize the detected object is car or a human being when this frame is captured by a single static camera. Write the complexities for such classification for the given scenario.
- Illustrate context based object recognition for scene understanding with an example.

- Develop an algorithm to recognize objects based on shape in a cluttered environment, for example an office table comprises of penstand, stapler, cup and water bottle etc.

Course Outcome 5 (CO5):

- Develop a face recognition system using PCA subspace approach for authentication system to enter into the restricted zone.
- Develop an algorithm using shape and motion as cues to classify normal vs abnormal behaviour of a human.
Hint: Consider normal behaviour as walking and abnormal behaviour as running.
- Develop an algorithm to recognize a marker, determine its pose, and overlay a circle on the image showing the location of the on/off switch as an overlay.
- Illustrate scene understanding for an indoor scenario, for example one laboratory of your department with main components.

Concept Map

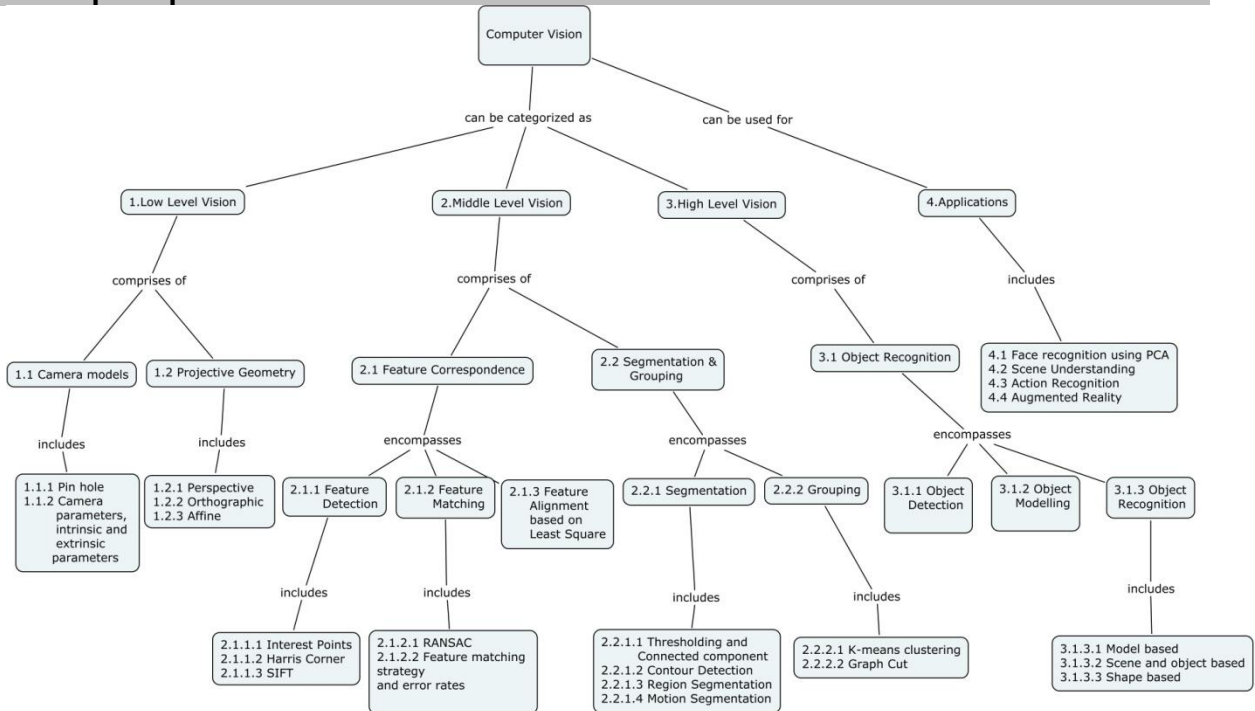

Syllabus

Introduction to Computer Vision, Camera models and Projective Geometry:

Introduction to Computer Vision, Applications, Camera Model- Pinhole camera, Camera parameters, intrinsic and extrinsic parameters, Projective Geometry- Perspective Projection, Orthographic Projection, Affine Projection, camera parameters for perspective projection

Feature Detection, Matching and Alignment: Interest point detection, corner detection, SIFT, Feature matching- RANSAC, matching strategy and error rates, 2D Feature based Alignment- Least squares method

Segmentation and Grouping: Segmentation-Thresholding and Connected component algorithm, Contour Detection, Region Segmentation, Motion Segmentation- Grouping- K-means clustering, Graph cut

Object Recognition: Object detection, Object Modeling, Model-based Object Recognition, Scene and Object Recognition, Shape based Object Recognition.

Applications: Face Recognition using PCA, Scene Understanding, Action Recognition, Augmented Reality

Text Book

- R Szeliski, "Computer vision: algorithms and applications", Springer Science & Business Media, 2010.

Reference Books

1. David A. Forsyth, Jean Ponce, "Computer Vision – A Modern Approach", Prentice Hall, 2003, ISBN: 0130851981.
2. Richard Hartley and Andrew Zisserman, "Multiple View Geometry in Computer Vision", Second Edition, Cambridge University Press, March 2004.
3. Al Bovik, "Handbook of Image & Video Processing", Academic Press, 2000, ISBN: 0121197905.
4. Chris Stauffer and W.E.L Grimson, "Adaptive background mixture models for real-time tracking". In IEEE Computer Vision and Pattern Recognition, volume 2, pages 2242–2252, June 1999.
5. <http://www.ius.cs.cmu.edu/demos/facedemo.html>

Course Contents and Lecture Schedule

No.	Topic	No. of Lectures
1	Low Level Vision: Camera models and Projective Geometry:	
	Camera models and Projective Geometry: Introduction to Computer Vision, Course Objectives and Outcomes, Review on Digital Image Processing and its Applications	2
1.1	Camera Models	2
1.1.1	Pinhole cameras	
1.1.2	Camera parameters, intrinsic and extrinsic parameters	1
1.2	Projective Geometry	1
1.2.1	Perspective projection, intrinsic and extrinsic parameters for perspective projection	
1.2.2	Orthographic projection	1
1.2.3	Affine projection	1
2	Mid Level Vision:	
2.1	Feature Correspondence:	
2.1.1	Feature detection	1
2.1.1.1	Interest point detection	
2.1.1.2	corner detection	1
2.1.1.3	SIFT	1
2.1.2	Feature matching	2
2.1.2.1	RANSAC	
2.1.2.2	Feature matching strategy and error rates	1
2.1.3	Least squares method based feature alignment	1
2.2	Segmentation and Grouping:	
2.2.1	Segmentation	1
2.2.1.1	Thresholding and Connected component algorithm	
2.2.1.2	Contour detection	1
2.2.1.3	Region segmentation	1
2.2.1.4	Motion segmentation	1
2.2.2	Grouping	1
2.2.2.1	K-means clustering	
2.2.2.2	Graph cut	2
3	High level Vision:	
3.1	Object Recognition:	
3.1.1	Object detection	1
3.1.2	Object modelling	1
3.1.3	Object recognition	2

3.1.3.1	Model-based object recognition	
3.1.3.2	Scene and object recognition	2
3.1.3.3	Shape based object recognition	1
4	Applications:	
4.1	Face recognition using PCA	2
4.2	Scene understanding	2
4.3	Action recognition	1
4.4	Augmented Reality	2
	Total	36

Course Designer:

1	Dr.B. Yogameena	ymece@tce.edu
---	-----------------	--



14ECRC0	SATELLITE IMAGE ANALYSIS	Category	L	T	P	Credit
		PE	3	0	0	3

Preamble

Remote Sensing (RS) refers to the science of identification of earth surface features by measuring portion of reflected or emitted electromagnetic radiation from earth's surface by sensors onboard manmade satellites orbiting around the earth. The output of a remote sensing system is usually an image representing the scene being observed. Many further steps of digital image processing and modeling are required in order to extract useful information from the image. This course deals with various image processing techniques that are applied on satellite images for the purpose of geometric & radiometric correction, enhancement, feature extraction, classification, fusion and compression operations.

Prerequisite :

14EC570 Image Processing

Course Outcomes

On the successful completion of the course, students will be able to

CO1. Describe the techniques for removing errors from satellite data and understand the nature of the image through their statistics.	Remember
CO2. Understand and apply the different types image enhancement techniques to improve the visual quality of satellite images	Understand
CO3. Apply various feature extraction techniques to extract statistical, structural and spectral features from satellite images	Apply
CO4. Analyze the performance of supervised and unsupervised methods used for mapping different earth surface features in an image	Analyze
CO5. Perform various fusion and compression algorithms over satellite data for the purpose of higher spatial & spectral information and removing the data redundancies.	Apply

Mapping with Programme Outcomes

COs	PO 1	PO 2	PO 3	PO 4	PO 5	PO 6	PO 7	PO 8	PO 9	PO 10	PO 11	PO 12	PSO 1	PSO 2	PSO 3
CO1	M	L	-	-	-	-	-	L	-	-	-	-	L	-	-
CO2	S	M	L	-	M	-	L	L	M	L	-	-	M	L	L
CO3	S	M	L	-	M	M	M	L	M	L	-	-	M	L	L
CO4	S	S	M	L	M	M	M	L	M	L	-	L	S	M	L
CO5	S	M	L	-	M	M	M	L	M	L	-	L	M	L	L

S- Strong; M-Medium; L-Low

Assessment Pattern

Bloom's Category	Continuous Assessment Tests			Terminal Examination
	1	2	3	
Remember	20	0	0	0
Understand	40	40	30	30
Apply	40	60	40	40
Analyze	0	0	30	30
Evaluate	0	0	0	0
Create	0	0	0	0

Course Level Assessment Questions**Course Outcome (CO1)**

1. What is meant by geometric correction?
2. How does the satellite sensor characteristics affect the satellite data quality?
3. What do you mean by spatial resolution of a satellite image?
4. How do we achieve the radiometric correction process for a raw satellite data?

Course Outcome (CO2)

1. Why do we need contrast stretching for a satellite data.
2. How do we Geo-reference a satellite data?.
3. Consider an image of size 3*3 and its noise affected version image.
Calculate the SNR related quality parameters.?
4. The following table shows the histogram of a poor contrast grey scale Image:

Grey level i	0	1	2	3	4	5	6	7	8	9	10	11	12	13	14	15
n_i	15	0	0	0	0	70	110	45	70	35	0	0	0	0	0	15

Modify the same image as a high contrast one.

5. The following table gives the number of pixels at each of the grey levels in an image with those grey values only:

0	1	2	3	4	5	6	7
3244	3899	4559	2573	1428	530	101	50

Draw the histogram corresponding to these grey levels, and then perform histogram equalization and draw the resulting histogram.

Course Outcome (CO3)

1. .Classify the following image into 3 classes using K- means clustering.

12	6	5	13	14	14	16	15
11	10	8	5	8	11	14	14
9	8	3	4	7	12	18	19
10	7	4	2	10	12	13	17
16	9	13	13	16	19	19	17
12	10	14	15	18	18	16	14
11	8	10	12	14	13	14	15
8	6	3	7	9	11	12	12

2. Construct a binary image of size 4x4. Apply the dilation and erosion morphological operations with a square structuring element with suitable size. Comment on the output.
3. Compute the GLCM matrix at $(d=1, 0^\circ)$ for the following image of size 4x4 and derive the possible features from the GLCM matrix.

0	0	1	1
0	0	2	2
1	1	2	3
4	4	3	3

Course Outcome (CO4)

1. In a multi spectral image of size 512 X 512, each pixel is associated with 7 bytes of colour information; How many bytes are required to store that image?
2. Consider the following matrices of size 4x4. Apply any four vegetation index parameters and analyze the results.
Im-R = [23 25 26 29; 31 35 32 34; 26 25 35 34;45 42 47 46]
Im-IR= [45 46 48 49; 58 59 65 68;86 89 75 76;95 96 85 78]
3. Construct a binary image of size 4x4. Apply the dilation and erosion morphological operations with a square structuring element with suitable size. Comment on the output

Course Outcome (CO5)

1. Construct panchromatic and multispectral images of an area with the size of 4x4 . Apply the brovey method to fuse these two images. Comment the results.
2. Use Huffman coding strategy to achieve compression on the following image. Obtain the redundancy and analyze the output with respect to lossless .



3. Construct an information string with the length of 20 symbols/digits. Apply any four run length coding compression strategies to achieve compression. Also calculate the efficiency.

2 5 3 2 3
0 0 3 2 3
4 4 3 2 1
7 5 3 2 1
5 5 4 2 1

Concept Map

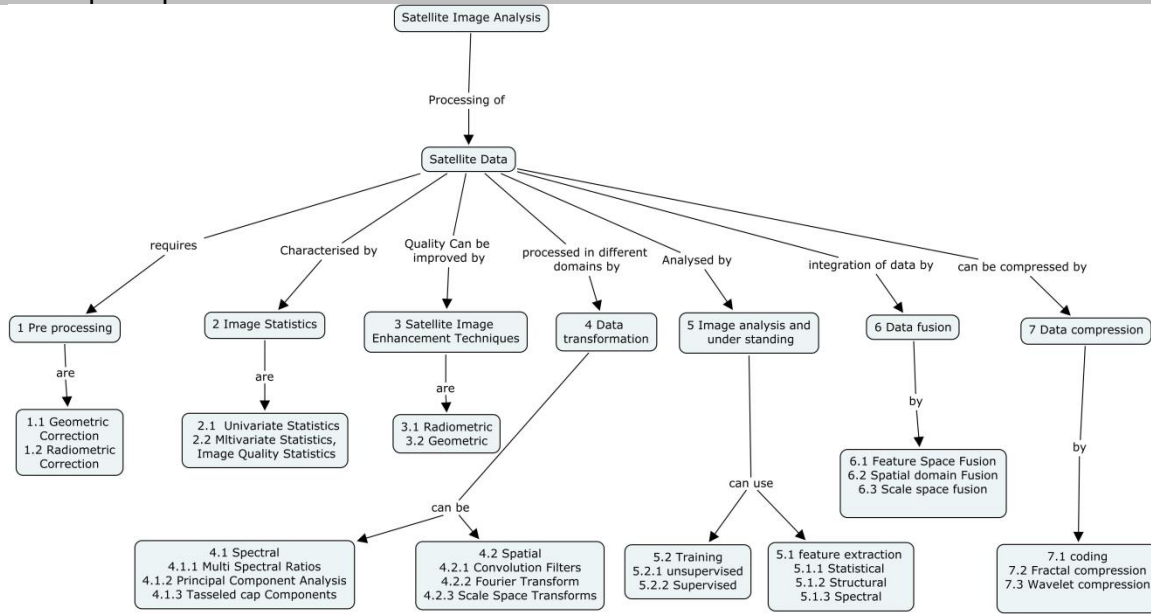

Syllabus

Satellite Data: Satellite Image Characteristics, Preprocessing- Geometric Correction, Radiometric Correction, **Image Statistics:** Univariate Statistics, Multivariate Image Statistics, Image Quality statistics, **Satellite Image Enhancement:** Radiometric Enhancement-Histogram Based Enhancements, Density Slicing, Stretching, Geometric Enhancement-Neighborhood Operations, Template Operators, **Data Transformation:** Spectral Transforms - Multispectral Ratios - Vegetation Indexes, Principal Components, Tasseled-Cap Components, Color-Space Transforms, Spatial Transforms – Convolution, Fourier Transform, Scale Space Transforms, **Image Analysis And Understanding:** Feature Extraction- Statistical, Structural, Spectral, Training –Supervised, Unsupervised, Hybrid Training, **Data Fusion:** Feature Space fusion, Spatial domain fusion, Scale space fusion, **Data Compression:** Compression by coding, Fractal Compression, Wavelet Compression.

Text Book:

1. Robert A. Schowengerdt, Remote Sensing Models & Methods For Image Processing, III Edition, 2004.
2. J. A. Richards “Remote Sensing Digital Image Analysis: An Introduction”, Second Revised Edition, 1993.

Reference Books:

1. Thomas M.Lillesand, Ralph W.Kiefer, “Remote Sensing And Image Interpretation”, Fifth Edition, 2004.
2. John R. Jensen, “Remote Sensing Of The Environment – An Earth Resource Perspective”, Pearson Education Series, 2003.
3. Rafael C.Gonzalez, Richard E.Woods, “Digital Image Processing” (3rd Edition) Rafael C.Gonzalez, Richard E.Woods, Prentice Hall, 2007.

Course Contents and Lecture Schedule

No.	Topic	No. of Lectures
1.	Satellite Data	
1.1	Satellite Image Characteristics	1
1.2	Geometric Correction	1

No.	Topic	No. of Lectures
1.3	Radiometric Correction	1
2.	Image Statistics	
2.1	Univariate Statistics	1
2.2	Multivariate Statistics, image quality statistics	1
3.	Satellite Image Enhancement	
3.1	Radiometric Enhancement	1
3.1.1	Histogram Based Enhancements, Density slicing	1
3.1.2	Stretching	1
3.2	Geometric Enhancement	1
3.2.1	Neighborhood Operations, Template operators	1
4.	Data Transformation	
4.1	Spectral Transforms	1
4.1.1	Multispectral Ratios	1
4.1.2	Vegetation Indexes	1
4.1.3	Principal Components	1
4.1.4	Tasseled-Cap Components	1
4.1.5	Color-Space Transforms	1
4.2	Spatial Transforms	1
4.2.1	Convolution	1
4.2.2	Fourier Transform	1
4.2.3	Scale Space Transforms	3
5.	Image Analysis And Understanding	
5.1	Feature Extraction	1
5.1.1	Statistical	1
5.1.2	Structural	1
5.1.3	Spectral	2
5.2	Training	1
5.2.1	Supervised	2
5.2.2	Unsupervised	1
5.2.3	Hybrid Training	1
6.	Data Fusion	
6.1	Feature Space fusion	1
6.2	Spatial domain fusion	1
6.3	Scale space fusion	2
7.	Data Compression	
7.1	Compression by coding	1
7.2	Fractal Compression	1
7.3	Wavelet Compression	2
	Total No. of Hours	40

Course Designers

1. Dr. B.Sathya Bama sbece@tce.edu
2. Dr. R.A.Alagu Raja alaguraja@tce.edu

14ECRD0	DATA COMPRESSION	Category	L	T	P	Credit
		PE	3	0	0	3

Preamble

Data compression is a key part of almost every aspect of computer and communications technology. Irrespective of large storage systems, the concern of space optimization and the algorithmic aspects of the efficiency looms large. Developing techniques to achieve better transmission rates is paramount importance today. Data compression is grounded in information theory, and there are many fundamental algorithms that one must deal with daily in information transmission and storage tasks. The objective of this course is to introduce the lossy and lossless compression techniques in text, audio, image and video signals. The course will start with the basic theory behind these methods followed by techniques that are used to augment the performance of the compression algorithms. Image/ Video compression standards like JPEG, MPEG and H.264 will also be discussed. The course will contain both mathematical and analytical components.

Prerequisite

14EC440, 14EC570

Course Outcomes

On the successful completion of the course, students will be able to

CO1. Understand the information theory related to data	Understand
CO2. Understand and apply different probabilistic coding techniques on data	Apply
CO3. Apply dictionary based techniques to compress textual data	Apply
CO4. Characterize the influence of transform coding techniques on image and video compression	Apply
CO5. Model and apply audio compression schemes	Apply

Mapping with Programme Outcomes

COs	PO 1	PO 2	PO 3	PO 4	PO 5	PO 6	PO 7	PO 8	PO 9	PO 10	PO 11	PO 12	PSO 1	PSO 2	PSO 3
CO1	M	L	-	-	-	-	-	-	-	-	-	L	L	-	-
CO2	S	M	L	-	M	-	-	L	M	-	-	-	M	L	-
CO3	S	M	L	L	M	L	-	L	M	L	-	L	M	L	L
CO4	S	M	L	L	L	L	-	L	M	L	-	L	M	L	L
CO5	S	M	L	L	L	M	-	L	M	L	-	L	M	L	L

S- Strong; M-Medium; L-Low

Assessment Pattern

	Bloom's category	Continuous Assessment Tests			End Semester Examinations
		1	2	3	
1	Remember	20	20	20	20
2	Understand	30	30	20	20
3	Apply	50	50	60	60
4	Analyze	0	0	0	0
5	Evaluate	0	0	0	0

6	Create	0	0	0	0
---	--------	---	---	---	---

Course Level Assessment Questions

Course Outcome 1 (CO1):

1. Define modeling?
2. State entropy
3. Discuss redundancies
4. What is the term "rate" in compression?
5. What are Digrams?
6. What is E3 mapping?

Course Outcome 2 (CO2):

1. Why do we go for extended Huffman code?
2. Consider a source alphabet with probabilities $A=\{a_1, a_2, a_3, a_4, a_5\}$ with $P(a_1)=P(a_3)=P(a_4)=0.2$, $P(a_2)=0.3$ and $P(a_5)=0.1$. Will the Huffman and minimum variance Huffman code have the same average length?
3. How integer arithmetic could be used to generate binary code and examine the same for the typical scenario of $u(n) = 54$ and $l(n) = 33$ with $m = 6$.
4. For an alphabet $A = \{a_1, a_2, a_3, a_4\}$ with probabilities $P(a_1) = 0.1$, $P(a_2) = 0.3$, $P(a_3) = 0.25$, $P(a_4) = 0.35$ Find Huffman code and compare with the minimum variance procedure. Also comment on the difference.
5. Why Huffman code is called optimum code?
6. How do we start decoding in arithmetic coding process?

Course Outcome 3 (CO3):

1. Encode the sequence with lossy differential scheme: 4.2, 1.8, 6.2, 9.7, 13.2, 5.9, 8.7, 0.4
2. Build the dictionary of diagram coding for '3' letter alphabet $S = \{a, b, c\}$
3. Encode the following sequence by LZ77 approach with window = 14 , LAB = 5 a b c a r a d a b r a r r a a d r r
4. How LZW algorithm is implemented to achieve graphic interchange format?

Course Outcome 4 (CO4):

1. Compare MH, MR, MMR
2. Discuss about Facsimile encoding technique.
3. Explain how compression is obtained with Adaptive DPCM
4. Discuss about Wavelet coding
5. Explain how JPEG Image compression is obtained using transform coding
6. Show that for any sequence $x = (x_1, x_2, \dots, x_n)$, upper bound and lower results in a recursive expression. Provide comparison of facsimile coding algorithms.
7. Explain MPEG-1 standard for video information.

Course Outcome 5 (CO5):

1. Explain about MPEG-4 Audio Lossless Coding(ALS)
2. How do you estimate pitch period in the linear predictive coding of speech?
3. Explain linear prediction model.
4. Compare various Audio compression techniques

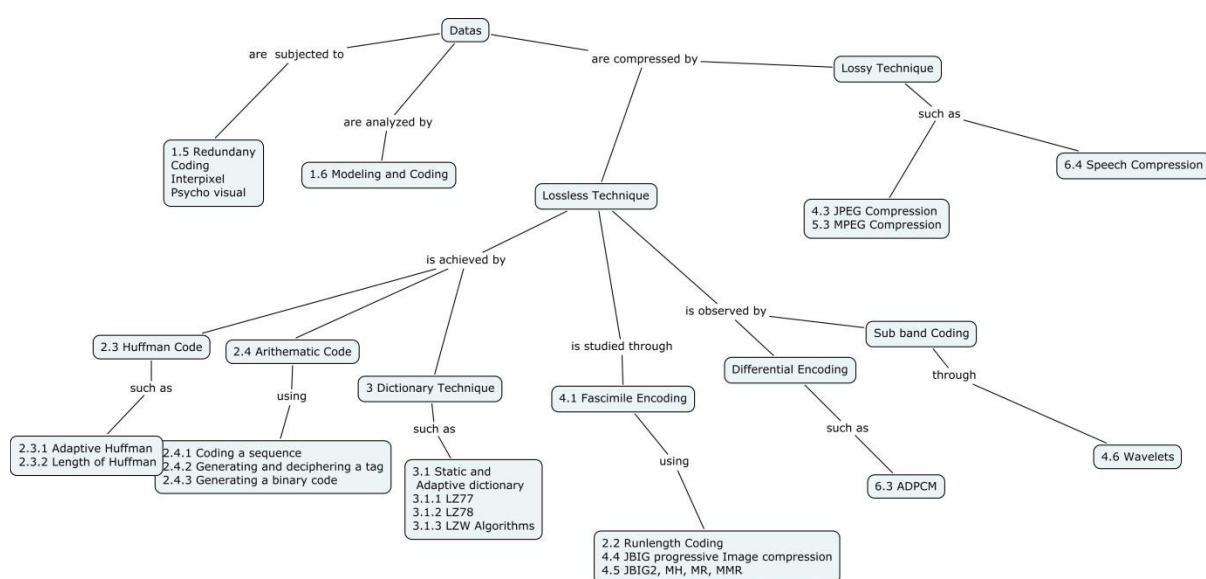
Concept Map**Syllabus**

Information Theory - Transmission medium characteristics, Theoretical limits of compressibility, Entropy, Information Value, Redundancy, Coding, Interpixel, Psychovisual, Modeling and Coding. **Statistical Methods** - Shannon-Fano Algorithm, Run-length coding, Huffman Algorithm, Arithmetic Coding. **Dictionary Methods** - Static and Adaptive dictionary, LZ77, LZ78, LZW Algorithms. **Image Compression** - Facsimile and gray scale compression, GIF, JPEG and JBIG progressive image compression, JBIG2, MH, MR, MMR, Wavelets. **Video Compression** - Motion Compensation, Temporal and Spatial Prediction, MPEG and H.264. **Audio Compression** - Digital Audio, WAVE Audio Format, ADPCM Audio Compression, Speech Compression, FLAC, MPEG-4 Audio Lossless Coding(ALS), MPEG-1/2 Audio Layers.

Text Book

1. Khalid Sayood, "Introduction to Data Compression" Fourth Edition, Morgan Kauffmann Publishers, Inc, Newnes, 2012.

Reference Books

1. David Salomon, "Data Compression: The Complete Reference" Fourth Edition Springer Science & Business Media, 2007.
2. David Salomon, "A Guide to Data Compression Methods" Fourth Edition Springer Science & Business Media, 2013.
3. Darrel Hankerson, Greg A. Harris, and Peter D. Johnson Jr, "Introduction to information theory and data compression". CRC press, 2003.

Course Contents and Lecture Schedule

S.No.	Topics	No. of Lectures
1.	Introduction to Information Theory	1
1.1	Transmission medium characteristics	1
1.2	Theoretical limits of compressibility	
1.3	Entropy	1
1.4	Information Value	
1.5	Redundancy: Coding, Interpixel, Psychovisual	1
1.6	Modeling and Coding	

2.	Statistical Methods	
2.1	Shannon-Fano Algorithm	1
2.2	Run-length coding	
2.3	Huffman Algorithm	1
2.3.1	Adaptive Huffman Coding	1
2.3.2	Length of Huffman code	1
2.4	Arithmetic Coding	1
2.4.1	Coding a sequence	
2.4.2	Generating and deciphering the tag	1
2.4.3	Generating a binary code	
2.4.4	Adaptive Arithmetic Code	1
3.	Dictionary Methods	
3.1	Static and Adaptive dictionary	1
3.1.1	LZ77	1
3.1.2	LZ78	1
3.1.3	LZW Algorithm	2
4.	Image Compression	
4.1	Facsimile and gray scale compression	1
4.2	GIF compression	1
4.3	JPEG compression	2
4.4	JBIG progressive image compression	1
4.5	JBIG2, MH, MR, MMR	2
4.6	Wavelets	2
4.6.1	Wavelet Methods	
4.6.2	Discrete Wavelet Transform	1
4.6.3	JPEG 2000	1
5	Video Compression	
5.1	Motion Compensation	1
5.2	Temporal and Spatial Prediction	1
5.3	MPEG (Frame-by-frame compression, Inter-frame compression) and H.264	2
6.	Audio Compression	
6.1	Digital Audio	1
6.2	WAVE Audio Format	1
6.3	ADPCM Audio Compression	1
6.4	Speech Compression	1
6.5	FLAC	1
6.6	MPEG-4 Audio Lossless Coding(ALS)	1
6.7	MPEG-1/2 Audio Layers	1

Course Designers:

1. Dr.S.Md.Mansoor Roomi smmroomi@tce.edu
2. Dr.B.Sathyabama sbece@tce.edu

14ECRE0	ELECTROMAGNETIC INTERFERENCE AND COMPATIBILITY	Category	L	T	P	Credit
		PE	3	0	0	3

Preamble

This course aims at understanding the sources of EMI/EMC and estimation, standards, Filters to remove noise and EMI/EMC measurement for compliances.

Prerequisite

14EC431: RF Transmission Lines and Passive Circuits(0r) 15EC431: RF Transmission Lines and Passive Circuits

Course Outcomes

On the successful completion of the course, students will be able to

CO1. understand the effects of EMI-EMC and their sources of origination and the standards and estimate the non ideal behaviour of passives at high frequencies	Apply
CO2. Synthesize EMI rejection filters for a particular application	Analyse
CO3. Calculate the effects of shielding and grounding in a circuit environment	Apply
CO4. Determine the cross talk effects in time and frequency domain	Apply
CO5. Evaluate EMI/EMC through measurement	Analyze

Mapping with Programme Outcomes

COs	PO 1	PO 2	PO 3	PO 4	PO 5	PO 6	PO 7	PO 8	PO 9	PO 10	PO 11	PO 12	PSO 1	PSO 2	PSO 3
CO1	S	M	L	L	-	-	-	-	-	L	-	-	S	-	-
CO2	S	S	M	L	L	-	-	-	-	L	-	L	S	L	-
CO3	S	M	L	-	-	-	-	-	L	L	-	L	S	-	-
CO4	S	M	L	-	-	-	-	-	-	L	-	L	S	-	-
CO5	S	S	S	M	-	-	-	-	M	-	-	-	S	L	-

Assessment Pattern

Bloom's Category	Continuous Assessment Tests			Terminal Examination
	1	2	3	
Remember	10	10	0	0
Understand	30	20	20	20
Apply	60	50	60	60
Analyse	0	0	20	20
Evaluate	0	0	0	0
Create	0	0	0	0

Course Level Assessment Questions**Course Outcome 1 (CO1)**

1. What do you mean by EMI and EMC?
2. Enumerate at least three sources of EMI
3. Name three International standards for EMI-EMC
4. Write the International standards of EMI- EMC for the following
5. Electric Motor, 2. PCB, SMPS, Antenna Tower with Antenna
6. What are the needs for modelling the passive devices at high frequencies

Course Outcome 2 (CO2)

1. A differential-mode (DM) filter is needed to attenuate noise emission from an uninterruptable power supply (UPS). The equivalent DM noise source impedance of the UPS can be modelled as a resistance of 2Ω in series with an inductance of $5 \mu H$. The UPS is connected to a Line Impedance Stabilization Network (LISN). Design the DM filter using the following components: Two capacitors ($0.2 \mu H$ each with a self-resonant frequency of 5 MHz) and one inductor ($5 \mu F$ with a self-resonant frequency of 2 MHz). Draw the full circuit with your designed filter.
 - (a) If the filter has two capacitors only, what is the filter attenuation at 200 kHz, 10 MHz and 100 MHz, respectively?
 - (b) Determine the filter attenuation of the filter designed in part (b) at 100 kHz, 1 MHz and 10 MHz.
2. Design a second order common-mode (CM) filter to attenuate the CM conducted noise generated by a switched mode power supply (SMPS). The SMPS is powered through a line impedance stabilization network (LISN). The equivalent CM noise source impedance of the SMPS can be modelled as a capacitor of 1000 pF. The CM circuit has to be realized by two capacitors of value 2000 P.F with self resonance frequency of 5 MHz and one inductor with inductance of 1mH with self resonance frequency of 10 MHz

Course Outcome 3 (CO3)

1. A microcontroller is kept inside painted shielded chamber 25cm X 20cm X 10 cm with the painting thickness of $60 \mu m$ with conductivity and permeability are 5×10^7 S/m and $6\pi \times 10^{-7}$ H/m respectively. The cross section of the chamber has a slot of 2 mm width with 15 cm length to insert the microcontroller. Considering the microcontroller acts as a loop antenna and the distance between the card and the paint is about 8 cm determine the shielding effectiveness (SE) of the coating between 100 MHz to 800 MHz and determine the frequencies at which the SE deteriorates.
2. A power supply board is placed near an tarpaulin shed with aluminium coating The conductivity of Aluminium is 3.55×10^7 S/m. Assuming the tarpaulin shed is much bigger than the power board and assuming the power board acts as circular loop antenna, determine the shielding effectiveness The effect of the tarpaulin plastic can be ignored in all the calculations..

Course Outcome 4 (CO4)

1. A two-layer printed circuit board (PCB). A voltage regulator (VR) provides DC power to an integrated circuit(IC) through the power and ground planes of the PCB. When the IC is in operation, it draws the current from the capacitor in saw tooth form with amplitude of 100 mA , with rising edge of 2 nS and period 20nS. Assume that the capacitor is ideal and its capacitance is large enough to supply the current to the IC.
 - (a) Will the PCB comply with CISPR 22 Class B limit as given in Table. Justify your answer by calculating and plotting the radiated electric field spectrum against the limit up to 1 GHz.
 - (b) What is the purpose of adding the capacitor next to the IC?

Frequency in MHz	Electric Field Limit at 10 m in dB $\mu V/m$
30-230	30
230-1000	37

2. A dipole as a transmitting antenna and a circularly polarized patch receiving antenna are separated by a distance D and a height H , The patch antenna is tilted by an angle α from the vertical axis.

(a) Show that the polarization mismatch loss (PML) is given by:

$$\text{PML (dB)} = 20 \log [\cos (\alpha - \beta)] - 3, \text{ where } \beta = \tan^{-1} (H/D).$$

(b) Given that $D = 10$ m and $H = 1.2$ m, determine the tilt angle α that will result in minimum PML. Compute the PML under this condition.

Course Outcome 5 (CO5)

1. Compare and contrast various EMI measurement set up with respect to their size, design complexity and versatility.
2. What are the measurement set up to measure Conducted emission and radiation emission

Concept Map

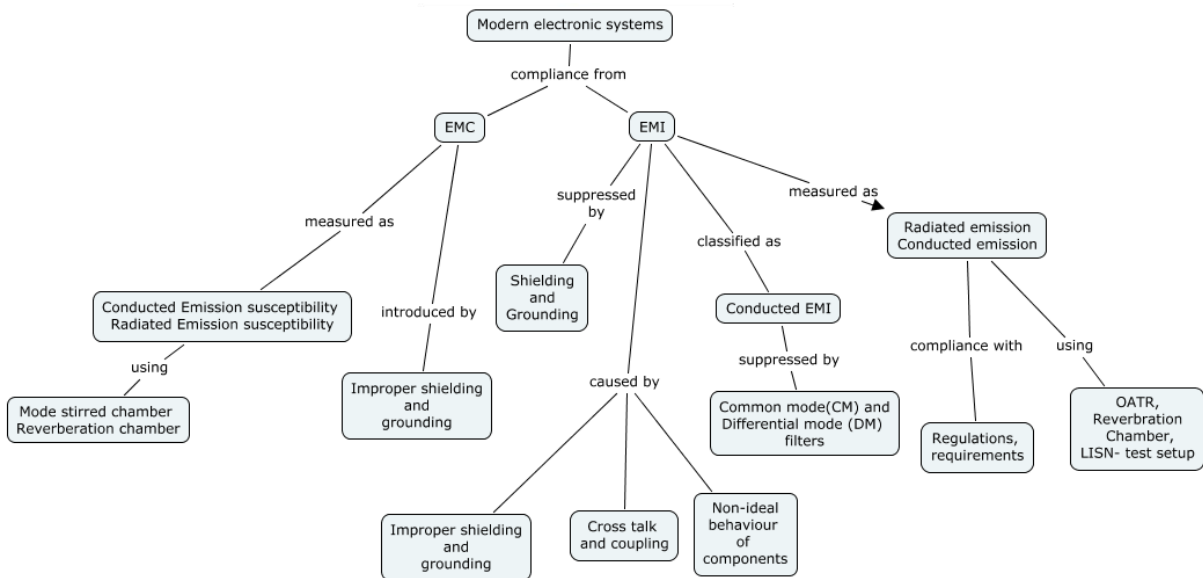

Syllabus

EMI & EMC - Frequency allocation - International EMI regulations - EMI radiations - EMC requirements - EMC units and conversion - **Non - Ideal behaviour of conductors** - dc/ac resistance - inductance between two parallel conductors - capacitance between two parallel wires - equivalent circuit model of RLC

Conducted EMI and Filter design - Power supply to active - passive load - conducted EMI through power grid - conduction mode (CM) EMI - Differential Mode (DM) EMI - CM filter - DM filter - integrated EMI filter- CM & Dm chokes & capacitor - effective EMI filter design - Lay out consideration for EMI coupling.

Electromagnetic shielding - shielding mechanism - absorption loss - reflection loss - multiple reflection loss - resultant shielding effect (SE) calculations - single opening & multiple opening- cavity resonance of a shielded enclosure - **Grounding** - safety ground - signal ground - grounding for different systems - power systems conventional models - electronic systems- DC / RF circuit transmission line model - parameter calculation - single point ground - multi point ground- Practical grounding Approach

Cross talk and Coupling - cross talk analysis at low frequency - capacitive cross talk - Near end & far end cross talk - estimation of cross talk - Inductive cross talk - Propagation delay in digital signals - Time domain cross talk - near end and far end - short and open load
EMI Testing - Parallel plate - TEM - GTEM - Open area test range - shielded enclosure - anechoic chamber - mode stirred chamber - Reverberation chamber- EMI Rx- LISN-EMI Measurement - conducted Emission - conducted susceptibility - radiated emission - radiated susceptibility

Reference Books

1. Reinhold Ludwig and Pavel Bretchko, RF Circuit Design: Theory and Applications, Prentice Hall, 2000, Chapter 1.
2. Clayton R. Paul, Introduction to Electromagnetic Compatibility, 2nd Edition, Wiley Interscience, 2006, Chapter 5 & 11.
3. Jasper Goed bloed, Electromagnetic Compatibility, 1990, Prentice Hall, Chapter 6.
4. High-Speed Digital System Design, Stephen H. Hall, Wiley Inter-Science, 2000.
5. Handbook series on Electromagnetic Interference and compatibility, Vol 6, Electromagnetic interference test methodology and procedures, E. L. Bronaugh, W. S. Lambdin, ICT 1995
6. Engineering Electromagnetic Compatibility, Principles, Measurements, and Technologies, V. P. Kodali, IEEE Press, 1996
7. K. V. Tarateeraseth, K. Y. See, F. G. Canavero and W. Y. Chang, "Systematic electromagnetic interference filter design based on information from in circuit impedance measurement", *IEEE Trans. on Electromagnetic Compatibility*, Aug. 2010, Vol. 52, No. 3, pp. 588-598.
8. V. Tarateeraseth, L. B. Wang, K. Y. See and F. G. Canavero, "Systematic power line EMI filter design for SMPS", EMC Europe, Sep. 2011, York, United Kingdom, pp. 586 – 591.

Course Contents and Lecture Schedule

Module No.	Topic	No. of Lectures
	Introduction	1
1	EMI & EMC - Frequency allocation - International EMI regulations - conditions for EMC	1
1.1	Typical examples EMI radiations - EMC requirements - EMC units and conversion	1
1.2	Ideal behaviour of conductors - dc/ac resistance - skin depth - internal / external inductance-	2
1.2.1	Inductance between two parallel conductors - capacitance between two parallel wires -	2
1.2.2	Equivalent circuit model of an resistor - inductor - capacitor	2
2.1	Conducted EMI and Filter design - Power supply to active - passive load - equivalent circuit model - conducted EMI through power grid -	1
2.2	Measurement of Conducted EMI - Conducted EMI measurement with LISN - conduction mode (CM) EMI - Differential Mode (DM) EMI	1
2.3	CM filter - DM filter design	4
2.4	Integrated EMI filter- CM & Dm chokes & capacitor - effective EMI filter design - Lay out consideration for EMI coupling.	
3.1	Electromagnetic shielding - shielding mechanism - absorption loss	2

Module No.	Topic	No. of Lectures
3.1.1	Reflection loss - multiple reflection loss - resultant shielding effect (SE) calculations -	2
3.1.2	Single opening & multiple opening- cavity resonance of a shielded enclosure	2
3.2	Grounding - safety ground - signal ground - grounding for different systems - power systems conventional models -	1
3.2.1	Electronic systems- DC / RF circuit transmission line model - parameter calculation -	3
3.2.2	Single point ground - multi point ground- Practical grounding Approach	1
4.1	Cross talk and Coupling - cross talk analysis at low frequency	1
4.2	Capacitive cross talk - Near end & far end cross talk - estimation of cross talk - Inductive cross talk -	2
4.3	Propagation delay in digital signals - Time domain cross talk - near end and far end - short and open load	4
5.1	EMI Testing - Parallel plate - TEM - GTEM -	1
5.2	Open area test range - shielded enclosure - anechoic chamber -	2
2.2	Mode stirred chamber - Reverberation chamber	1
5.3	LISN-EMI Measurement - conducted Emission - conducted susceptibility -	2
5.4	radiated emission - radiated susceptibility	2

Course Designers:

1. Dr.S.Raju , rajuabhai@tce.edu
2. Dr.A.Thenmozhi thenmozhi@tce.eduS

14ECRF0	RF MEMS	Category	L	T	P	Credit
		PE	3	0	0	3

Preamble

The course is offered in the seventh semester elective course in continuation with the course on RF Passive and Active Circuits. The performance of current RF (Radio Frequency) systems can be enhanced by replacing critical components by their micromechanical counterparts, MEMS (Micro Electro Mechanical Systems). This is a strong drive for developing RF MEMS units. The course will start by giving an overview of various applications of MEMS and benefits of micromachining and also aims at modeling of various RF MEMS components. The course concludes by giving a short overview of packaging and the usage of the MEMSCAD tools such as Intellisuite and Coventoreware.

Prerequisite

14EC431: RF Transmission Lines and Passive Circuits(0r) 15EC431: RF Transmission Lines and Passive Circuits

Course Outcomes

On the successful completion of the course, students will be able to

CO1. Summarize the Concept of miniaturization, need for MEMS in various applications and also the need for packaging.	Understand
CO2. Explain the concepts of various actuation mechanisms of MEMS.	Understand
CO3. Design and analyze RF MEMS components such as switches, capacitors, phase shifters and antennas.	Apply
CO4. Generalize Micro fabrication techniques.	Understand
CO5. Utilization of RF MEMS CAD software	Understand

Mapping with Programme Outcomes

COs	PO 1	PO 2	PO 3	PO 4	PO 5	PO 6	PO 7	PO 8	PO 9	PO 10	PO 11	PO 12	PSO 1	PSO 2	PSO 3
CO1	M	L	-	-	-	-	-	-	-	-	-	-	L	-	-
CO2	S	M	L	-	-	-	-	-	-	-	-	L	-	-	-
CO3	S	M	L	-	-	-	-	-	M	L	-	L	S	-	L
CO4	M	L	-	-	-	-	-	-	-	-	-	L	L	-	-
CO5	S	M	L	-	L	-	-	-	M	L	-	S	L	-	-

S- Strong; M-Medium; L-Low

Assessment Pattern

Bloom's Category	Continuous Assessment Tests			Terminal Examination
	1	2	3	
Remember	0	0	0	0
Understand	50	50	50	50
Apply	50	50	50	50
Analyse	0	0	0	0
Evaluate	0	0	0	0
Create	0	0	0	0

Course Level Assessment Questions

Course Outcome 1 (CO1):

1. Tabulate the direct analogy of electrical and mechanical domains.
2. Classify MEMS packages. Based on the need for packaging of MEMS devices classify and differentiate various packaging methodologies.
3. Mention few MEMS softwares?
4. What is miniaturization? What do you mean by scaling?
5. Differentiate Bulk and Surface micro machining.

Course Outcome 2 (CO2):

1. Compare and contrast various actuation mechanisms.
2. Applying the various actuation mechanisms, discuss how MEMS capacitors can be realized?

Course Outcome 3 (CO3):

1. Design a RF MEMS shunt switch with an equivalent circuit approach operating at a frequency of 40 GHz.
2. Determine the fragg frequency and the phase shift per unit length of a DMTL phase shifter at a frequency of 10 GHz.
3. i)Applying the concepts of direct analogy between electrical and mechanical domains Convert the mechanical model of a RF MEMS shunt switch to electrical model.
ii) Derive the expression for pull down voltage of a switch.
4. Tabulate and compare the performance parameters of a RF switch with MEMS Switches.
5. List the ways of designing RF MEMS capacitors and explain the draw backs present in two plate system. How three plate system provides better capacitance ratio.
6. How radiation occurs from microstrip antennas. Comment on the various choices of micromachining techniques for realizing microstrip antennas.

Course Outcome 4 (CO4):

1. What is PVD and CVD?
2. What do you mean by top to bottom design approach?
3. a)Classify the materials used for MEMS fabrication.
b) List the properties of silicon nitride.
4. With the help of diagrams explain the different process steps involved in the bulk micromachining technology for realizing a polysilicon cantilever beam.
5. When do you prefer flip-chip assembly technology of packaging? justify.

Course Outcome 5 (CO5):

1. Compare and contrast the usage of Intellisuite and Coventorware MEMS CAD tools.
2. List the important features of coventorware MEMS CAD tool.

Concept Map

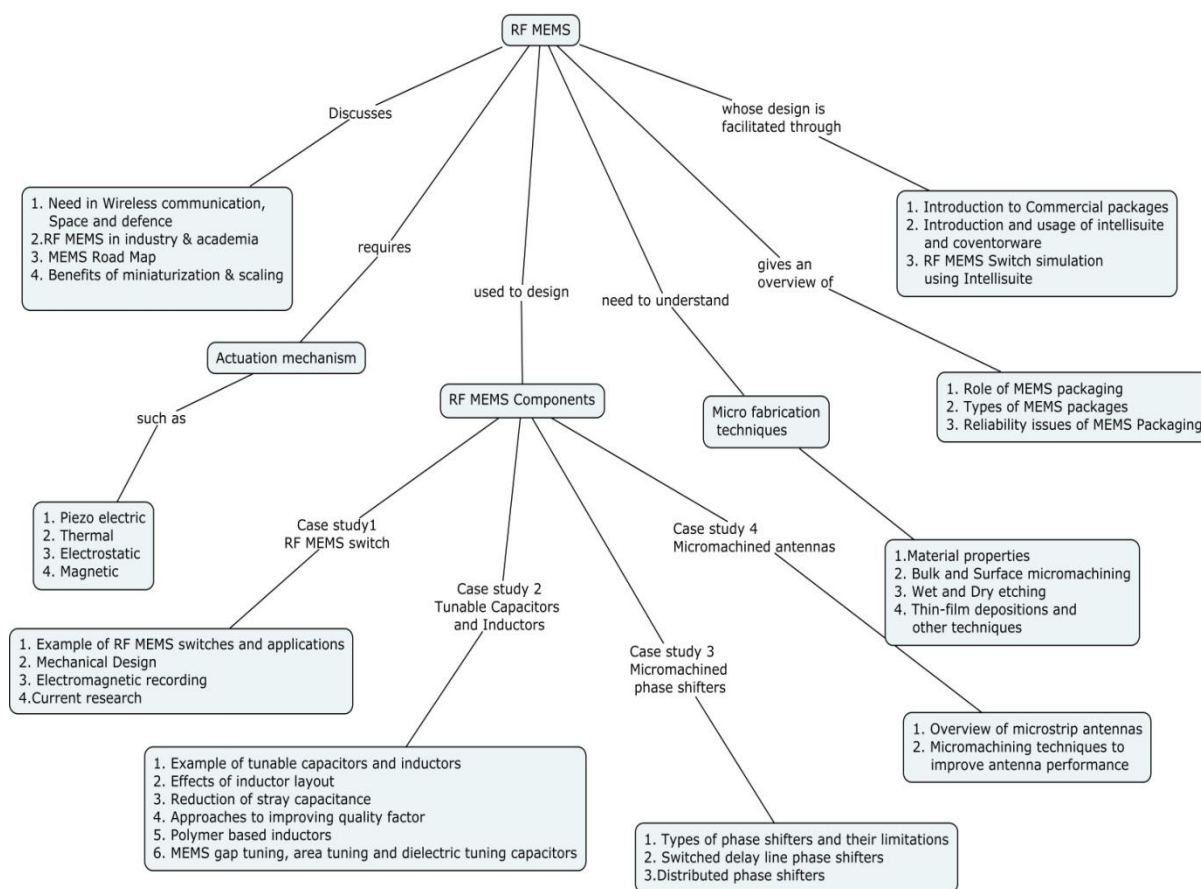

Syllabus

Introduction to RF MEMS: Application in wireless communications, space and defense applications, Benefits of Miniaturization and Scaling, RF MEMS in industry and academia.

Actuation Mechanisms in MEMS: Piezoelectric, Electrostatic, Thermal and Magnetic.

RF MEMS Components: Case study 1: MEMS Switch, Example of RF MEMS switches and applications, Mechanical design, Electromagnetic modeling (Capacitance, Loss, Isolation), Current research **Case Study 2: Tunable Capacitors and Inductors,** Example of tunable capacitors and inductors and their applications in circuits, Effect of inductor layout, reduction of stray capacitance of planar inductor, Approaches for improving quality factor, Polymer based inductors, MEMS gap tuning, area tuning and dielectric tuning capacitors, **Case study 3: Micromachined phase shifters:** Types of phase shifters and their limitations, MEMS phase shifters: Switched delay line phase shifters, Distributed phase shifters **Case study 4: Micromachined antennas:** Microstrip antennas, Micromachining techniques to improve antenna performance.

Micro fabrication Techniques: MEMS Materials, Material Properties, Bulk and surface micromachining, Wet and dry etching Thin-film depositions (LPCVD, Sputtering, Evaporation), other techniques (LIGA, Electroplating).

Packaging of RF MEMS : Role of MEMS packaging, Types of MEMS Packages, Reliability issues of MEMS packaging.

Computer aided design of MEMS: Introduction to Commercial packages, Introduction and usage of Intellisuite and Coventorware, RF MEMS Switch simulation using Intellisuite.

Reference Books

1. Vijay K Varadhan, K.J. Vinoy "RF MEMS and their Applications", John Wiley & Sons, 1998.
2. K.J Vinoy, K.N Bhat, V.K Aatre "Micro and Smart Systems", John Wiley & Sons, 2010

Course Contents and Lecture Schedule

Sl.NO	Topic	No. of Lectures
1	Introduction to RF MEMS	
1.1	Application in wireless communications, space and defense applications	1
1.2	Benefits of Miniaturization and Scaling, MEMS road map	1
1.3	RF MEMS in industry and academia	1
2	Actuation Mechanisms in MEMS	
2.1	Piezoelectric, Electrostatic	1
2.2	Thermal, Magnetic	1
3	RF MEMS Components	
3.1	Case study 1: RF MEMS Switches	1
3.1.1	Example of RF MEMS switches and applications	1
3.1.2	Mechanical design	1
3.1.3	Electromagnetic modeling (Capacitance, Loss, Isolation)	1
3.1.4	Current research in MEMS switches	1
3.2	Case study 2: Tunable Capacitors and Inductors	1
3.2.1	Example of tunable capacitors and inductors and their applications in circuits	2
3.2.2	Effect of inductor layout, reduction of stray capacitance of planar inductor	2
3.2.3	Approaches for improving quality factor	1
3.2.4	MEMS gap tuning, area tuning and dielectric tuning capacitors	2
3.3	Case study 3: Micromachined phase shifters	2
3.3.1	Types of phase shifters and their limitations	1
3.3.3	MEMS phase shifters: Switched delay line phase shifters, Distributed phase shifters	2
3.4	Case study 4: Micromachined Antennas	
3.4.1	Microstrip antennas	1
3.4.2	Micromachining techniques to improve antenna performance	2
4	Micro fabrication Techniques: Materials Properties, Bulk and surface micromachining	
4.1	Wet and dry etching Thin-film depositions (LPCVD, Sputtering, Evaporation), other techniques (LIGA, Electroplating)	1
5	Packaging of RF MEMS: Role of MEMS packaging	1
5.1	Types of MEMS Packages	2
5.2	Reliability issues of MEMS packaging	1
6	Computer aided design of MEMS: Introduction to Commercial packages, Introduction and usage of Intellisuite and Coventorware RF MEMS Switch simulation using Intellisuite	5
	Total	36

Course Designers:

1.	Dr.S.Raju	rajuabhai@tce.edu
2.	Dr.S.Kanthamani	skmece@tce.edu

14ECRG0	PLANAR ANTENNAS FOR WIRELESS APPLICATIONS	Category	L	T	P	Credit
		PE	3	0	0	3

Preamble

The tremendous success enjoyed by the cellular phone industry and advances in radio frequency integrated circuits have in recent years fostered the development of various wireless communication systems including near field, indoor and outdoor applications. For aesthetic reasons, all these systems require small antennas that can be embedded into the base station and user equipments. Furthermore, the development of new services and radio technologies demand for low cost, light weight, miniaturized, efficient antennas for portable wireless devices. One of the main competencies that a present day antenna engineer has to possess is the capability to design antennas for portable wireless devices that have good bandwidth, gain and radiation characteristics.

This subject is essential to understand the need for designing broadband and miniaturized antennas for wireless applications such as Mobile handsets, Radio frequency identification, Zigbee, Wearable devices and Ultra wide band communication. This course presents various types of antenna geometry suitable for the above mentioned wireless devices, the issues in respect of their design and development. One of the main competencies that a present day communication engineer has to acquire is the capability to design antennas for wireless applications that provide good bandwidth and gain.

Prerequisite

14EC350 - Electromagnetics

14EC530 - Antennas and wave Propagation

Course Outcomes

On the successful completion of the course, students will be able to

CO1	Explain the requirements of an antenna for wireless applications in terms its parameters	Understand
CO2	Simulate the radiation pattern of antennas using EM CAD simulator software-ADS	Understand
CO3	Identify, design antennas for typical applications including RFID, Zigbee, cellular, wearable devices and UWB communication	Analyze
CO4	Simulate, Develop prototype of a designed antenna	Apply
CO5	Measure the antenna parameters	Apply

Mapping with Programme Outcomes

COs	PO 1	PO 2	PO 3	PO 4	PO 5	PO 6	PO 7	PO 8	PO 9	PO 10	PO 11	PO 12	PSO 1	PSO 2	PSO 3
CO1	M	L	-	-	-	-	-	-	-	-	-	-	-	-	-
CO2	M	L	-	-	-	-	-	-	-	-	-	-	-	-	-
CO3	S	S	L	-	-	-	-	-	M	M	-	L	M	-	-
CO4	S	M	S	M	S	-	-	-	M	M	L	L	M	L	-
CO5	S	M	S	M	L	-	-	-	L	L	-	-	L	L	-

S- Strong; M-Medium; L-Low

Assessment Pattern

Bloom's Category	Continuous Assessment Tests			Terminal Examination
	1	2	3	
Remember	20	20	20	0
Understand	40	30	20	40
Apply	40	40	40	40

Analyze	0	10	20	20
Evaluate	0	0	0	0
Create	0	0	0	0

Course Level Assessment Questions

Course Outcome (CO1)

- 1.What are the features of 3G wireless systems?
- 2.Explain the spectrum allocation for various wireless applications.
- 3.List some of the antennas used in handset.
- 4.Explain the radiation mechanism of PIFA antenna and their parameters.

Course Outcome (CO2)

1. What are the effects of environment on RFID Tag antenna?
2. What are the effects of user on the mobile unit performance?
3. Why monopole antennas are preferred for wireless communication in Laptop?
4. Compare active and passive RFID's
5. What wireless antenna can be used to cover a small campus area of a few buildings?

Course Outcome (CO3)

- 1.Design a mini wireless antenna for Laptop computer applications.
- 2.Design a planar inverted F antenna operating in Cellular GSM lower band.
- 3.Suggest a suitable planar antenna system for the given specification:
Center Frequency - 5GHz
Dielectric constant – 3.38
Thickness - 1.52mm
VSWR - 2:1
Bandwidth > 500MHz
- 4.Design a conformal, flexible E shaped antenna for wearable antenna application.

Course Outcome (CO4)

- 1.Propose simulation steps to facilitate the design of patch antenna on a multilayer substrate having effective dielectric constant of 5.5.
- 2.Derive the maximum reading distance of a tag in a RFID system.
- 3.Evaluate the performance of PC card antenna and INF antenna in a laptop prototype.
- 4.Prepare a model chart for developing antenna for wearable devices considering different RF constraints.

Concept Map

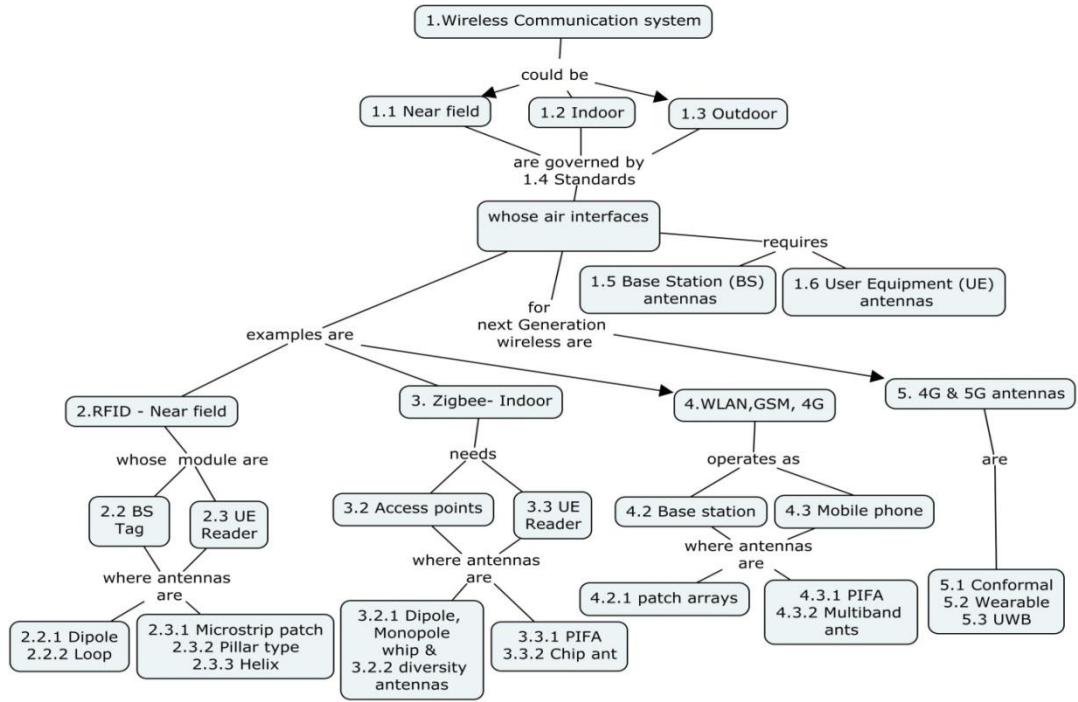

Syllabus

Introduction: Evolution of wireless communications, Key terms and concepts, Wireless systems and standards – Applications, Air interface- Near field, Indoor, Outdoor, Requirements of antenna for above applications, Base station (BS) and User equipment (UE) antennas

Near field applications: RFID Frequency, Regulations and Standardization, Reader Air interface parameters- power, data rate. Types of readers - Handheld, Fixed, high power. Reader antennas- Specifications- gain, bandwidth and polarization, Microstrip patch, pillar antennas and design.

RFID Tag Antennas: Tag architecture- Tag, clip type, Types of Tag-Dipole, loop, design considerations, Radio Link, Parameters, Effect of Environment on RFID Tag Antennas. Design of reader and tag antennas.

Antennas for Indoor applications: Zigbee and WLAN: air interface, frequency, Bandwidth and data rate requirement. Specification & topologies, Antennas for Zigbee/WLAN Access points- Dipoles, monopoles, whip antennas, diversity. Antennas for user equipment- design challenges- gain, efficiency, SAR and size constraints. Topologies- PIFA & Chip antennas and design.

Cellular antennas: Cellular applications, Performance Requirements, Mode of operation, Base station antenna- specifications and challenges, topologies, Electrically Small Antennas, Topologies- Patch arrays, Beam tilting, null fill. User equipment- antenna design challenges, Multiband PIFA, SAR, Practical Design- Simulations, prototype, Measurements.

Antennas for next Generation wireless Applications: U4G & 5G communication, challenges, form factor and broadband performance, Conformal, wearable and UWB antennas

Reference Books

1. Zhi Ning Chen, "Antennas for Portable devices" Wiley Publishers, 2007
2. R.Waterhouse "Printed antennas for wireless communications" John Wiley Publishers
3. Peter S.Hall, Yang Hao "Antennas and propagation for body-centric wireless communications"
4. J.C.Liberti, JR and Theodore Rappaport, "Smart Antennas for Wireless communication" Prentice Hall of India, 1999.
5. Grishkumar and K.P.Ray, "Broadband microstrip antennas" Artech House, 2003
6. John D.Kraus, Ronald J.Marhefka "Antennas for all Applications" Fourth Edition, Tata McGraw- Hill, 2006.

Course Contents and Lecture Schedule

Module No	Topics	No. of Lectures
	Introduction:	
1	Evolution of wireless communications, Key terms and concepts,	2
2	Wireless systems and standards – Applications,	1
3	Air interface- Near field, Indoor, Outdoor	1
4	Requirements of antenna for above applications, Base station (BS) and User equipment (UE) antennas	3
5	Tutorial	4
	Near field applications:	
6.	RFID Frequency, Regulations and Standardization	1
7.	RFID Reader: Air interface parameters- power, data rate, Types of readers- Handheld, Fixed, high power	1
8.	Reader antennas- Specifications- gain, bandwidth and polarization	1
9.	Microstrip patch, pillar antennas and design.	2

10.	RFID Tag Antennas:Tag architecture- Tag, clip type,	1
11.	Types of Tag-Dipole , loop, design considerations	1
12.	Radio Link, Parameters, Effect of Environment on RFID Tag Antennas. Design of reader and tag antennas.	2
13.	Tutorial	3
	Cellular antennas:	
14	Cellular applications, Performance Requirements, Mode of operation,	1
15	Base station antenna- specifications and challenges, topologies,	1
16	Electrically Small Antennas, Topologies- Patch arrays, Beam tilting, null fill.	2
17	User equipment- antenna design challenges,	1
18	Multiband PIFA, SAR, Practical Design- Simulations	2
19	Tutorial	4
	Antennas for next Generation wireless Applications:	
20	4G & 5G communication	1
21	challenges, form factor and broadband performance,	1
22	Conformal, wearable and UWB antenna	3
	Tutorial & Mini project	4

Course Designers:

1	Dr.V.Abhaikumar	principal@tce.edu
2.	Dr.B.Manimegalai	naveenmegaa@tce.edu

14ECRH0	WIRELESS TECHNOLOGIES WITH MOBILE INTERNET	Category	L	T	P	Credit
		PE	3	0	0	3

Preamble

This course provides a preview of emerging wireless technologies and their architectural impact on the future mobile Internet and to enable the students to revise the curriculum of related courses in future with sufficient flexibility in the design of the course.

Prerequisite

14EC510 Data Communication Networks

Course Outcomes

On the successful completion of the course, students will be able to

CO1	Identify new protocol features for the future Internet.	Understand
CO2	Present an insight into the emerging wireless network technologies WLAN, Hyper lan, WPAN, WMAN	Understand
CO3	Plan and design of wireless communication systems with protocols.	Analyze
CO4	Analyze the performance of WLAN, Cognitive radio and VANETs	Analyze
CO5	Implement wireless ATM convergent network for real and non-real time services with QoS	Apply

Mapping with Programme Outcomes

COs	PO 1	PO 2	PO 3	PO 4	PO 5	PO 6	PO 7	PO 8	PO 9	PO 10	PO 11	PO 12	PSO 1	PSO 2	PSO 3
CO1	M	M	L	L	L	-	-	M	M	M	-	L	M	M	L
CO2	M	M	L	L	L	-	-	M	M	M	M	M	M	M	-
CO3	M	M	M	S	M	-	-	M	S	S	M	M	S	M	M
CO4	M	S	M	-	M	-	-	M	S	S	M	M	S	S	M
CO5	S	M	M	-	S	-	-	M	S	S	M	M	S	M	M

Assessment Pattern

Continuous Assessment Tests				End Semester Examinations
Bloom's Category	1	2	3	
Remember	20	20	20	0
Understand	40	40	20	40
Apply	40	40	40	20
Analyze	0	10	20	40
Evaluate	0	0	0	0
Create	0	0	0	0

Course Level Assessment Questions**Course Outcome 1 (CO1):**

1. Classify various wireless networking scenarios in emerging wireless technologies.
2. Identify the radio technologies and service trends in future generation wireless standards.
3. State the challenges for the implementation of VANETs.
4. What information is stored on RFID tags?
5. How does IEEE 802.1x overcome the security vulnerabilities of WEP?

6. Mention the radio access layer requirements of WATM.

Course Outcome (CO2):

1. Compare the salient features, advantage and disadvantage of IEEE 802.11 WLAN standard infrastructure and adhoc.
2. How does LTE-A enhance the features of existing LTE?
3. Compare and contrast WiFi-WiMAX-3G optical fiber deployment scenarios.
4. Give the requirements of cognitive radio.
5. Explain the concept behind WATM and compare its performance with other networks?
6. What are the key challenges in enabling protocols in VANETs for safety applications?

Course Outcome (CO3):

1. Find out the transmission range of a wireless node operating at 2.4 GHz with transmission power of 7dBm and receiver sensitivity of -81 dBm. Assume free space propagation.
2. The IEEE 802.11 WLAN system operates at 1 Mbps. Calculate the data transfer time of a 20 kB file.
3. Consider the HIPERLAN-2 standard that uses BPSK and $r=3/4$ codes for 9 Mbits/sec information transmission and 16 QAM with the same coding for the actual payload data transmission rate of 36 Mbits/sec.
 - a. Calculate the coded symbol transmission rate per subscriber for each of the two nodes. What is the bit transmission rate per subscriber for each of the two nodes?
 - b. If one switches from 32 Mbps mode to 9 Mbps mode, how much mode in DB of the path loss can it afford?
4. Identify the major challenges in implementing WATM that does not exist for data oriented Ethernet IEEE 802.3.

Course Outcome (CO4):

1. Analyze why packet switching is more efficient than circuit switching for bursty traffic?
2. Emphasize the benefits of CR to users on the way to a vision of future.
3. Illustrate the core protocol functions from which many MAC and cognitive protocol layers are built.
4. MANET Vs VANET. Analyze the difference.
5. Assess the scenario of vehicular sensor platforms where vehicles are used as data sources.
6. Explain how MobiMESH network architecture dynamically handles the connectivity as clients roam throughout the network.
7. A given MANET consists of 200 mobile nodes. The mobility of the nodes is such that four existing wireless links are broken, while four new wireless links are established every one second. Assume that each mobile node is connected to exactly four adjacent mobile nodes. Find the total number of wireless links at any time in the network.

Course Outcome (CO5):

1. Calculate the total delay experienced by a packet generated by a source travels over one link, gets buffered at a switch, is then routed to another link, and so on, until it arrives at its destination with example.
2. Calculate the packetization delay for i) 53 byte ATM cells ii) a thousand byte packet transfer service for a) voice samples that are sampled 8000 times per sec and encoded into a 64 bits per sec stream and b) MPEG1 which takes 30 video frames per sec and encodes them into a 1Mbps stream. (The packetization delay depends on the speed of information transfer).
3. Identify the propagation delay of a link from an earth station to a geostationary satellite and also identify the end-to-end delay of a voice conversation that is relayed via such a satellite?

Concept Map

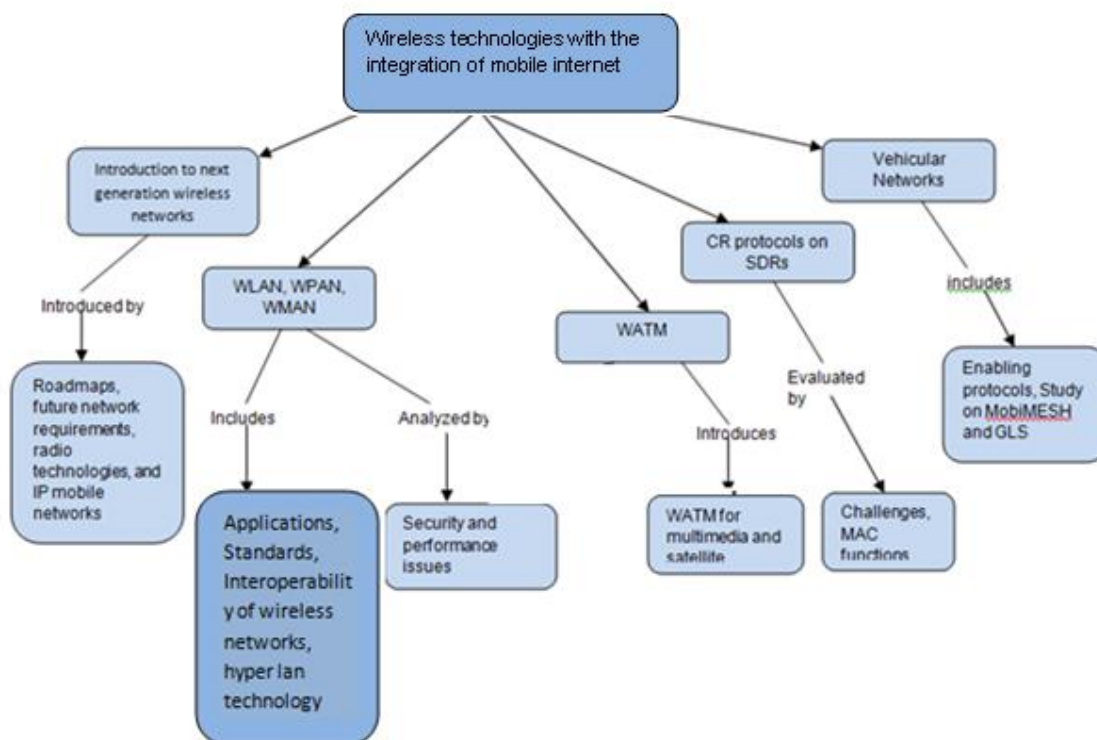

Syllabus

Introduction to wireless technologies: Background-roadmap-wireless network scenarios-future wireless network requirements. **Next Generation Wireless standards and their integration with the internet:** Technology and service trends- Radio technologies in next generation wireless standards-Spectrum management and cognitive radio networks-IP mobile networks-Mobility and vertical handover-Multihop wireless networks. **WLAN IEEE 802.11:** Standards-WLAN applications- System performance and security issues, Hyper lan Technology, **WPAN & WMAN:** Applications- standards, Interoperability of wireless networks, Wi-max and LTE/ 3GPP comparison, MMAC-PC standard, **Wireless ATM Networks:** WATM for Wireless, Multimedia and Satellite Communication, WATM prototypes, Commercial WATM systems for Local loop, **Supporting cognitive radio network protocols on software defined radios-** Software defined radio architecture and challenges-Core cognitive radio and MAC functions- MAC layer Evaluation, **Vehicular networks-** Introduction, Application, Enabling protocols, Study on MobiMESH and GLS.

Text Books

1. Dipankar Raychaudhuri, Mario Gerla, "Emerging Wireless Technologies and the Future Mobile Internet", ISBN: 978-0-521-11646-6, Cambridge University Press, 2011.
2. T.L. Singal, "Wireless Communications", Tata McGraw Hill Education Private Limited, ISBN: 978-0-07-068178-1 Second Edition, 2011,

Reference Books:

1. ITI Saha Misra, "Wireless Communications and Networks 3G and Beyond", Second edition, ISBN:978-1-25-906273-5, McGraw Hill Education Private Limited, 2009.
2. Wireless ATM- A Overview by Ayse Yasemin Seydim, Southern Methodist University, spring 2000.

Course Contents and Lecture Schedule

Module No.	Topics	No. of Lectures
1.	Introduction to wireless technologies	
1.1	Background	2
1.2	Roadmap	1
1.3	Wireless network scenarios	2
1.4	Future Wireless network requirements	1
2.	Next Generation Wireless Standards and their integration with the internet	
2.1	Technology and service trends	1
2.2	Radio technologies in next generation wireless standards	2
2.3	Spectrum Management	1
2.4	Cognitive radio networks	1
2.5	IP Mobile networks	1
2.6	Mobility and vertical handover	1
2.7	Multi hop wireless networks	1
3	WLAN IEEE 802.11	
3.1	Standards	2
3.2	WLAN applications	1
3.3	System performance	1
3.4	Security Issues	1
3.5	Hyper LAN technology	1
4	WPAN & WMAN	
4.1	Applications	1
4.2	Standards: IEEE 802.15,802.16, 802.21	2
4.3	Interoperability of wireless networks	1
4.4	Wi-max and LTE/ 3GPP comparison	1
4.5	MMAC-PC standard	1
5	Wireless ATM Networks	
5.1	WATM for Wireless, Multimedia and Satellite Communication	2
5.2	Commercial WATM systems for Local loop	1
6	Supporting cognitive radio network protocols on software defined radios	
6.1	Software defined radio architecture and challenges	1
6.2	Core cognitive radio and MAC functions	1
6.3	MAC layer Evaluation	1
7	Vehicular networks	
7.1	Introduction	1
7.2	Application	1
7.3	Enabling protocols	1
7.4	Study on MobiMESH and GLS	1
Total		36

Course Designers

Dr. (Mrs). M. Suganthi

msuganthi@tce.edu

14ECRJ0	WIRELESS AD-HOC AND SENSOR NETWORKS	Category	L	T	P	Credit
		PE	3	0	0	3

Preamble

The objective of this course is to introduce students with fundamental concepts, design issues and solutions to the issues – architectures and protocols- and the state-of-the-art research developments in ad hoc and sensor networks.

Prerequisite

14EC510 Data Communication Networks

Course Outcomes

On the successful completion of the course, students will be able to

CO1	Identify the necessity of Ad Hoc and Sensor networks	Understand
CO2	Describe the operation of the routing and localization	Understand
CO3	Compute the power consumption and Euclidean distance of a sensor network	Apply
CO4	Analyze the MAC issues in Ad hoc and sensor networks	Analyze
CO5	Design sensor network for indoor applications	Apply

Mapping with Programme Outcomes

COs	PO 1	PO 2	PO 3	PO 4	PO 5	PO 6	PO 7	PO 8	PO 9	PO 10	PO 11	PO 12	PSO 1	PSO 2	PSO 3
CO1	M	L	-	-	L	-	-	M	M	M	-	M	L	-	L
CO2	M	L	-	-	M	-	-	M	M	M	L	L	L	L	L
CO3	S	M	L	-	M	-	-	M	M	S	M	M	M	L	M
CO4	S	S	M	-	M	-	-	M	S	S	S	M	S	L	M
CO5	S	M	L	-	M	-	-	M	S	S	S	M	M	L	M

S- Strong; M-Medium; L-Low

Assessment Pattern

Bloom's Category	Continuous Assessment Tests			Terminal Examination
	1	2	3	
Remember	0	0	0	0
Understand	40	40	30	40
Apply	60	60	50	40
Analyse	0	0	20	20
Evaluate	0	0	0	0
Create	0	0	0	0

Course Level Assessment Questions**Course Outcome 1 (CO1):**

1. Define hidden terminal problem and how it is alleviated at the MAC layer?
2. Define loop-free property ensured in on-demand routing protocols?
3. Identify and elaborate some of the important issues in pricing for multi hop wireless communication.
4. Enlist the applications of sensor networks.
5. Mention the future trends in sensor networks

Course Outcome 2 (CO2):

1. Identify the advantages and limitations of routing protocol that uses GPS information for an ad hoc wireless network for search and rescue operations.
2. Give application scenarios where contention-based, reservation-based and packet scheduling-based MAC protocols can be used.
3. Calculate the probability of data packet collision in the MACA protocol. Assume that T_c is the control packet transmission and propagation delay, T_w is the optimal maximum back-off time, β is the percentage of ready nodes, and R is the transmission range of each node.
4. Why is power management important for ad hoc wireless networks?
5. What role does the routing protocol play in the provisioning of QoS guarantees for ad hoc wireless networks?
6. How does data gathering done in WSN?

Course Outcome 3 (CO3):

1. Find out the probability of a path break for an eight-hop path, given that the probability of a link break is .2.
2. Consider the third iteration of LEACH protocol. If the desired number of nodes per cluster is ten, what is the threshold calculated for a node during its random number generation?
3. In FPRP, can a situation occur where a requesting node is not able to detect collisions that have occurred in the reservation request phase? If so, suggest simple modifications to solve the problem.
4. Consider sensors placed at (3,4), (2,5), (-4,3), (1,1) and (-3,-2). If the parameters λ and k in the sensing power computation are 1 and 2 respectively. What are the I_A and I_C at the origin (0,0)? (Consider Euclidean distance of p from s)
5. State the two basic approaches for the maintenance of multicast tree in BEMRP? Which of the two perform better? Why?
6. For the given topology, find the zone link state packets for the various zones marked.

Course Outcome 4 (CO4):

1. Channel quality estimation can be done both at the sender and receiver. Which is more advantageous? Why?
2. In the CGSR protocol, the resources of the node chosen as the cluster-head get drained very quickly, more rapidly than the other nodes in the cluster. How can this problem be overcome?
3. Point out the implications of an extension of split TCP. Where every intermediate node acts as proxy node
4. Analyze the effect of the carrier sensing zone of a transmission on the performance of a MAC protocol.
5. State the two basic approaches for the maintenance of multicast tree in BEMRP? Which of the two perform better? Why?
6. Assume that the current size of the congestion window is 48 KB, the TCP sender experiences a time out. What will be the congestion window size if the next three transmission bursts are successful? Assume that MSS is 1 KB. Consider TCP Tahoe and TCP Reno

Course Outcome 5 (CO5):

1. During a research discussion, one of your colleagues suggested an extension of split-TCP where every intermediate node acts as proxy node. What would be the implications of such a protocol?
2. Determine the back-off calculation mechanism used in DWOP. Is it guaranteed to be accurate at all times? If not, explain why?
3. Design a habitat monitoring system using sensor networks
4. Design and develop a Cross layer Design based sensor networks.

Concept Map

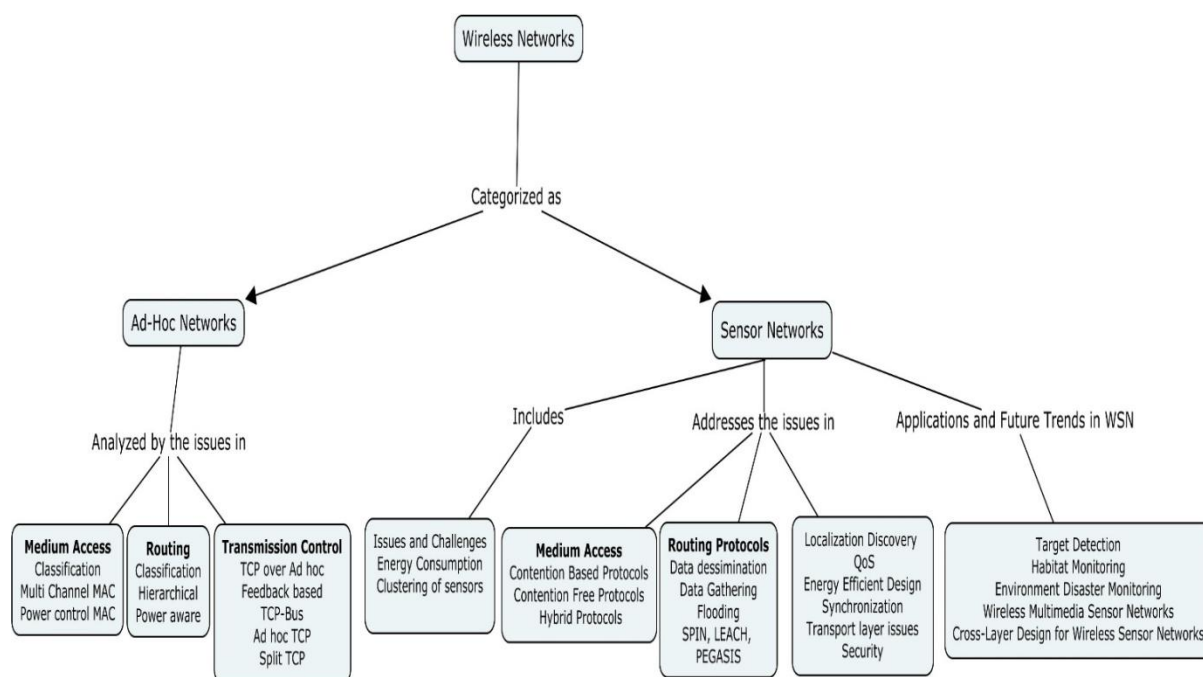

Syllabus

Ad-hoc Mac: Design Issues in Ad-Hoc Networks - MAC Protocols – Issues, Classifications of MAC protocols: Contention Based Protocols, Contention Based Protocols with reservation mechanisms, Contention Based Protocols with Scheduling Mechanism – MAC protocol with Directional Antenna - Multi channel MAC & Power control MAC protocol. **Ad-Hoc Routing protocols and Ad-Hoc Transport layer:** Issues – Classifications of routing protocols: Table Driven Protocols, On-Demand Routing Protocols, Hybrid Routing Protocols – Hierarchical and Power aware Routing Protocols – Ad Hoc Transport Layer Issues, TCP Over Ad Hoc – Feedback based, TCP with explicit link, TCP-Bus, Ad Hoc TCP, and Split TCP. **WSN:** Introduction – Design Issues and challenges – Energy consumption – Clustering of sensors **MAC protocols:** Classifications of MAC protocols: Contention Based Protocols, Contention Free Protocols, Hybrid Protocols. **Routing Protocols for Wireless Sensor Networks:** Data Dissemination – Data Gathering – Routing Challenges and Design Issues in WSN - Routing Strategies in Wireless Sensor Networks: Flooding and Its Variants - Sensor Protocols for Information via Negotiation(SPIN) - Low-Energy Adaptive Clustering Hierarchy(LEACH) - Power-Efficient Gathering in Sensor Information Systems(PEGASIS) - Directed Diffusion - Geographical Routing - Location Discovery – QoS – Other issues: Energy Efficient Design, Synchronization, Transport layer issues, Security. **Applications and Future Trends in Wireless Sensor Networks:** Target detection – Habitat Monitoring – Environment disaster Monitoring – Wireless Multimedia Sensor Networks - Cross-Layer Design for Wireless Sensor Networks

Text Book

1. C.Siva Ram Murthy and B.S. Manoj, “Ad Hoc Wireless Networks – Architectures and Protocols”, Pearson Education, 2004.

Reference Books

1. Jun Zheng and Abbas Jamalipour, “Wireless Sensor Network A Networking Perspective”, A John Wiley & Sons, Inc., Publication, 2009.
2. KazemSohraby, Daniel Minoli and TaiebZnati, “Wireless Sensor Networks: Technology, Protocols and Applications, A John Wiley & Sons, Inc., Publication, 2007.

3. Carlos de Morais Cordeiro, Dharma Prakash Agrawal, "Ad Hoc and Sensor Networks, Theory and Applications", World Scientific 2006.
4. Feng Zhao and Leonidas Guibas, "Wireless Sensor Networks", Morgan Kaufman Publishers, 2004.
5. C.K.Toth, "Ad Hoc Mobile Wireless Networks", Pearson Education, 2002.

Course Contents and Lecture Schedule

Module No.	Topic	No. of Lectures
1	Ad hoc Mac:	
1.1	Design Issues in Ad-Hoc Networks	1
1.2	MAC Protocols Issues	1
1.3	Classifications of MAC protocols: Contention Based Protocols	1
1.4	Contention Based Protocols with reservation mechanisms, Contention Based Protocols with Scheduling Mechanism	1
1.5	MAC protocol with Directional Antenna	1
1.6	Multichannel MAC	1
1.7	Power control MAC protocol	1
2	Ad-Hoc Routing protocols and Ad-Hoc Transport layer	
2.1	Issues, Classifications of routing protocols: Table Driven Protocols	2
2.2	On-Demand Routing Protocols, Hybrid Routing Protocols	2
2.3	Hierarchical and Power aware Routing Protocols	1
2.4	Ad Hoc Transport Layer Issues, TCP Over Ad Hoc	1
2.5	Feedback based, TCP with explicit link, TCP-Bus	2
2.6	Ad Hoc TCP, and Split TCP	1
3	WSN: MAC protocols	
3.1	Introduction of WSN	1
3.2	Design Issues and challenges and Energy consumption	2
3.3	Clustering of sensors	1
3.4	Classifications of MAC protocols: Contention Based Protocols	1
3.5	Contention Free Protocols, Hybrid Protocols	1
4	Routing Protocols for Wireless Sensor Networks:	
4.1	Data Dissemination, Data Gathering	1
4.2	Routing Challenges and Design Issues in WSN	2
4.3	Routing Strategies in Wireless Sensor Networks: Flooding and Its Variants	1
4.4	SPIN , LEACH , PEGASIS	2
4.5	Directed Diffusion, Geographical Routing	1
4.6	Location Discovery, QoS	1
4.7	Other issues: Energy Efficient Design, Synchronization, Transport layer issues, Security	1
5	Applications and Future Trends in Wireless Sensor Networks	
5.1	Target detection	1
5.2	Habitat Monitoring	1
5.3	Environmental disaster Monitoring	1
5.4	Wireless Multimedia Sensor Networks	1
5.5	Cross-Layer Design for Wireless Sensor Networks	1
Total		36

Course Designers:

1.	Dr.T.Aruna	tacee@tce.edu
----	------------	---------------

14ECRK0	COOPERATIVE COMMUNICATION SYSTEMS	Category	L	T	P	Credit
		PE	3	0	0	3

Preamble

The main purpose of this course is to introduce to the students the emerging areas of cooperative communication systems. This will enable the students to acquire a solid understanding of different cooperative protocols and their performance in wireless communication systems.

Prerequisite

14EC510:Data Communication Networks

Course Outcomes

On the successful completion of the course, students will be able to

CO1	Identify the necessity of cooperative communication	Remember
CO2	Describe the need for relay selection scheme	Understand
CO3	Determine the performance of AF cooperative protocols	Apply
CO4	Determine the SER of DSTC and DFSC based DF protocols	Apply
CO5	Analyse the MAC performance issues in AF and DF cooperative communication	Analyse

Mapping with Programme Outcomes

COs	PO 1	PO 2	PO 3	PO 4	PO 5	PO 6	PO 7	PO 8	PO 9	PO 10	PO 11	PO 12	PSO 1	PSO 2	PSO 3
CO1	S	M	L	-	S	-	-	M	M	M	M	M	M	L	M
CO2	M	L	-	-	M	-	-	M	M	M	L	M	L	L	M
CO3	S	M	L	-	S	-	-	M	S	S	M	M	M	L	M
CO4	S	M	L	-	S	-	-	M	S	S	M	M	M	L	M
CO5	S	S	M	-	S	-	-	M	S	S	S	M	S	L	M

S- Strong; M-Medium; L-Low

Assessment Pattern

Bloom's Category	Continuous Assessment Tests			Terminal Examination
	1	2	3	
Remember	20	20	0	0
Understand	20	20	40	40
Apply	60	60	50	50
Analyse	0	0	10	10
Evaluate	0	0	0	0
Create	0	0	0	0

Course Level Assessment Questions**Course Outcome 1 (CO1):**

1. Mention the phases in Cooperative communication strategy
2. Draw and explain the simplified relay model
3. Define the upper band of the aggregate network throughput
4. Define the capacity of SIMO channel

Course Outcome 2 (CO2):

1. Why half – duplex constrained is assumed in Cooperative communication
2. Distinguish between fixed and adaptive relay schemes
3. Give the challenges in achieving frequency diversity in wireless relay networks
4. Compare AF and DF protocols

5. How synchronization is achieved in randomly located relay nodes

Course Outcome 3 (CO3):

1. Derive an expression for outage probability of the following over Rayleigh fading
 - AF Protocol
 - DF Protocol
2. Compute the closed SER expression for the cooperative communication system with MPSK and MQAM modulation.
 - AF Protocol
 - DF Protocol
3. Determine the closed SER expression for the AF cooperative communication system with MPSK and MQAM modulation.
4. Calculate the SER under fading channel condition
5. Obtain the optimal power allocation formula for a linear network that minimizes the SER expression.

Course Outcome 4 (CO4):

1. Calculate the BW effect and SER upper band of single relay selection based DF cooperative scheme
2. Compute the performance when L=1 and L=2
 - AF Protocol
 - DF Protocol
3. Calculate the upper and lower bands of DF/ AF scheme
4. Apply the optimal power allocation strategy for the multi node network and obtain the SER with QPSK /QAM modulation for DF protocol

Course Outcome 5 (CO5):

1. Analyze the outage performance of selective relaying and incremental relaying
2. Analyze the phases of hierarchical Cooperative protocol
3. Develop the system model of DFSC based AF system compute the diversity order of the scheme
4. Design the DF based DSTC system for a 2 hop relay network and derive expression for its output response

Concept Map

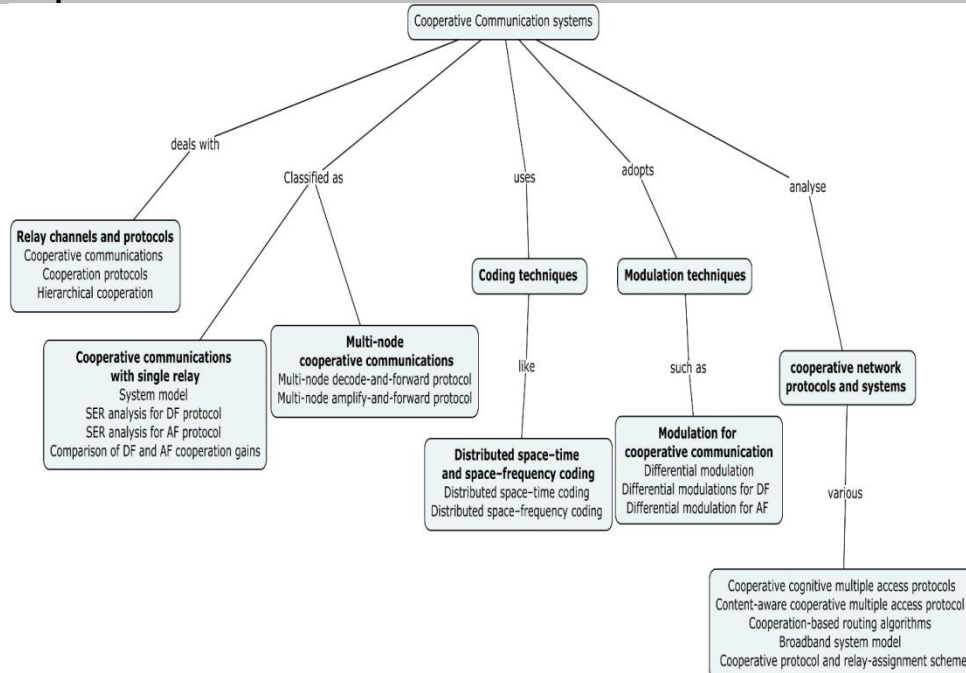

Syllabus

Relay channels and protocols: Cooperative communications - Cooperation protocols - Hierarchical cooperation **Cooperative communications with single relay:** System model - SER analysis for DF protocol - SER analysis for AF protocol - Comparison of DF and AF

cooperation gains **Multi-node cooperative communications:** Multi-node decode-and-forward protocol - Multi-node amplify-and-forward protocol **Distributed space–time and space–frequency coding:** Distributed space–time coding - Distributed space-frequency coding **Modulation for cooperative communication:** Differential modulation - Differential modulations for DF cooperative communications - Differential modulation for AF cooperative communications **Cooperative Networks:** Cooperative cognitive multiple access protocols-Content-aware cooperative multiple access protocol - Cooperation-based routing algorithms - Broadband system model - Cooperative protocol and relay-assignment scheme.

Text Book

1. K.J.Ray Liu, Ahmed K.Sadek, Weifeng Su and Andres Kwasinski, “Cooperative Communications and Networking”, Cambridge University Press 2009.

Reference Books

1. Peter Hong Y.W, Wan-Jen Huang, C.-C. Jay Kuo, “Cooperative Communications and Networking: Technologies and System Design” , Springer 2010.
2. Mischa Dohler and Yonghui Li, “Cooperative Communications: Hardware, Channel and PHY”, Wiley 2010.
3. Murat Uysal , “Cooperative Communications for Improved Wireless Network Transmission: Framework for Virtual Antenna Array Applications”, Information Science; 1 edition, 2009.

Course Contents and Lecture Schedule

Module No.	Topic	No. of Lectures
1	Relay channels and protocols	
1.1	Cooperative communications	2
1.2	Cooperation protocols	2
1.3	Hierarchical cooperation	2
2	Cooperative communications with single relay	
2.1	System model	1
2.2	SER analysis for DF protocol	2
2.3	SER analysis for AF protocol	2
2.4	Comparison of DF and AF cooperation gains	2
3	Multi-node cooperative communications	
3.1	Multi-node decode-and-forward protocol	2
3.2	Multi-node amplify-and-forward protocol	2
4	Distributed space–time and space–frequency coding	
4.1	Distributed space–time coding	2
4.2	Distributed space–frequency coding	2
5	Modulation for cooperative communication	
5.1	Differential modulation	1
5.2	Differential modulations for DF cooperative communications	2
5.3	Differential modulation for AF cooperative communications	2
6	Cooperative Network	
6.1	Cooperative cognitive multiple access protocols	2
6.2	Content-aware cooperative multiple access protocol	2
6.3	Cooperation-based routing algorithms	2
6.4	Broadband system model	2
6.5	Cooperative protocol and relay-assignment scheme	2
Total		36

Course Designers:

1.	Dr.T.Aruna	tacece@tce.edu
----	------------	----------------

14ECRL0	CAD FOR VLSI	Category	L	T	P	Credit
		PE	3	0	0	3

Preamble

The semiconductor industry has advanced tremendously over the last ten years with features sizes being downscaled from micrometer to nanometer regime today. Due to the increasing high complexity of modern VLSI chip design, Computer Aided Design (CAD) tools play an important role in delivering high system performance. The VLSI design professional needs to have a good understanding of the operation of these CAD VLSI design tools as these are developed primarily for and by the VLSI design professionals. This course introduces the techniques of modelling digital systems at various abstraction levels and exploring the various algorithms in VLSI physical design, which serve as a basis for the research and development of new Computer Aided Design (CAD) tools.

Prerequisite

14EC520 : Digital CMOS Systems

Course Outcomes

On the successful completion of the course, students will be able to

CO1	Demonstrate the knowledge of computational and optimization algorithms and tools applicable to solving CAD related problems	Understand
CO2	Describe the problems of complexity, productivity, and optimization algorithms in placement and partitioning.	Apply
CO3	Illustrate the Floorplanning concepts and its representation.	Apply
CO4	Analyse the various optimizations algorithms in VLSI Routing	Analyse
CO5	Representation mechanism for Boolean functions that has application in logic synthesis and Verification	Apply

Mapping with Programme Outcomes

COs	PO 1	PO 2	PO 3	PO 4	PO 5	PO 6	PO 7	PO 8	PO 9	PO 10	PO 11	PO 12	PSO 1	PSO 2	PSO 3
CO1	M	L	L	-	-	-	-	-	-	-	-	L	M	L	L
CO2	S	M	M	L	M	-	-	-	M	M	M	M	M	L	M
CO3	S	M	M	L	L	-	-	-	M	M	M	M	M	L	M
CO4	S	S	M	L	M	-	-	-	M	M	M	M	M	M	M
CO5	S	M	L	L	M	-	-	-	M	M	-	M	S	M	M

S- Strong; M-Medium; L-Low

Assessment Pattern

Bloom's category	Continuous Assessment Tests			End Semester Examinations
	1	2	3	
Remember	30	20	10	10
Understand	40	30	10	10
Apply	30	50	40	60
Analyze	0	0	40	20
Evaluate	0	0	0	0
Create	0	0	0	0

Course Level Assessment Questions

Course Outcome 1 (CO1):

1. Differentiate DFS and BFS search methods.
2. How the problems are classified based on the complexity?
3. Discuss on the VLSI Design methodologies used for IC layout design.
4. Explain the Gajski Y-chart.

Course Outcome 2 (CO2):

1. Explain how Kernighan-Lin algorithm is used for partitioning and using the algorithm, find the minimum cut for the graph shown in Figure.

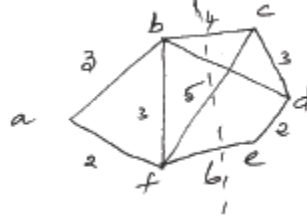

2. Using branch and bound algorithm, compute the search tree for the travelling salesman problem shown in Figure. Also write the pseudo code of the algorithm

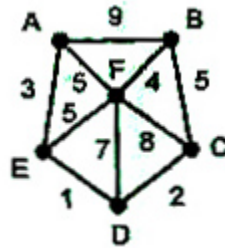

3. Find the shortest path between "A" and "E" in the graph shown in Figure using Dijkstra's algorithm and also find the minimum spanning tree for the same graph using Prim's algorithm

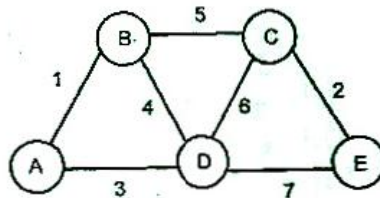

4. Design a cost function for the general building block placement problem which considers the wire length, estimated area, module overlap, and aspect ratio of the entire layout.

Course Outcome 3(CO3):

1. Prove that there is a one to one correspondence between a sliceable floorplan and a normalized Polish expression.
2. Given a Polish expression corresponding to a given a slicing floorplan, show that the expression 12-3-.....-n- can be reached and vice versa.
3. Find an optimal implementation of modules M_1, \dots, M_8 for sizing of the following sliceable floorplans.

Floor 1: 1 2 V 3 4 V H 5 6 V 7 8 V H V
 Floor 2: 1 2 V 3 4 V 5 H 6 V 7 H 8 V H

Course Outcome 4 (CO4):

1. List the parameters characterizing the local routing problem.
2. Show that left edge algorithm produces a solution, with a number of rows exactly equal to the density of the problem.
3. Draw the horizontal and vertical constraint graphs for the channel shown in below figure. Explain how to handle the net that exist the channel and its pseudo terminal.

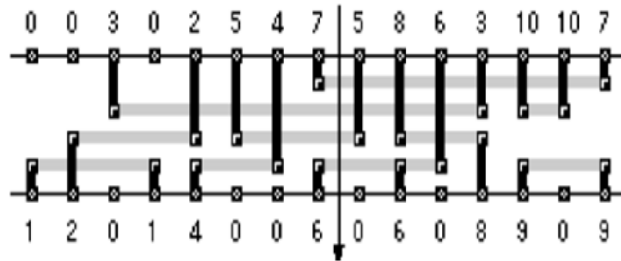

Course Outcome 5 (CO5):

1. Write the problem definition for two level logic synthesis.
2. For the Boolean function $f(x_1, x_2, x_3) = (0, 1, 2, 5, 6, 7)$. Find its locally and globally minimal irredundant prime cover.
3. With suitable example, explain hoe ROBDD can be used in different applications.
4. Draw the ROBDD for the given function $f = ab(c + d)$..

Concept Map

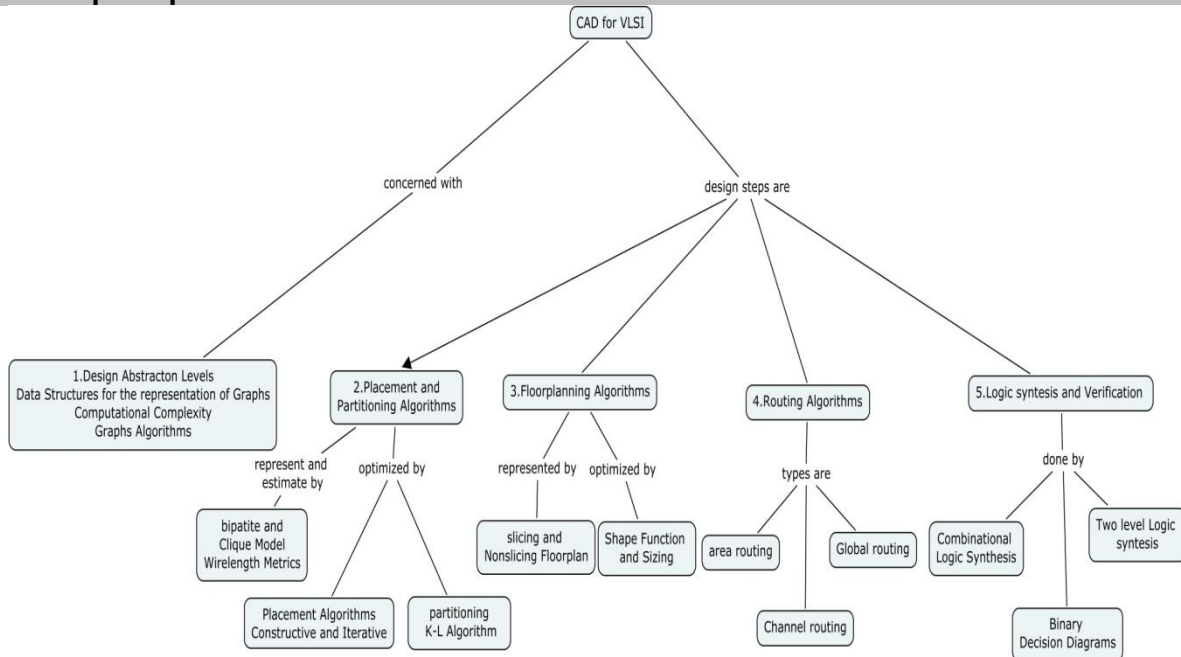

Syllabus

VLSI Design Automation Tools: Design Abstraction Levels, Data Structures for the representation of Graphs. Computational Complexity, Graphs Algorithms.

Placement and Partitioning Algorithms: Circuit Representation, Wire length Estimation, Placement Algorithms, Partitioning Algorithm.

Floorplanning Algorithms: Floorplanning Concept, Optimization Problems in Floorplanning, Shape Function and Sizing

Routing Algorithms: Local Routing Problems, Area Routing, Channel Routing, Global Routing, Algorithms for Global Routing.

Logic Synthesis and Verification: Combinational Logic Synthesis, Binary Decision Diagrams, ROBDD principles, ROBDD Manipulation, Variable Ordering, Two Level Logic Synthesis.

Text Book:

1. S.H. Gerez, *Algorithms for VLSI Design Automation*, Wiley-India, Reprint 2008

Reference Books:

1. Giovanni De Micheli, *Synthesis and Optimization of Digital Circuits*, Tata McGraw Hill, 1994
2. D.D Gajski et al., *High Level Synthesis: Introduction to Chip and System Design*, Kluwer Academic Publishers, 1992
3. N.A. Sherwani, *Algorithms for VLSI Physical Design Automation*, Kluwer Academic Publisher
4. M. Sarrafzadeh and C.K. Wong, *An Introduction to VLSI Physical Design*, McGraw Hill, 1996
5. Current Literature: *IEEE Trans. on CAD of ICs*, *IEEE Trans. on VLSI Systems*, *ACM TODAES*

Course Contents and Lecture Schedule

Module No	Topic	No. of Lectures
1	VLSI Design Automation Tools	
1.1	Design Abstraction Levels	2
1.2	Data Structures for the representation of Graphs	2
1.3	Computational Complexity	2
1.4	Graphs Algorithms	2
2	Placement and Partitioning Algorithms	
2.1	Circuit Representation	1
2.2	Wire length Estimation	1
2.3	Placement Algorithms	3
2.4	Partitioning Algorithm	3
	Assignment I – Implement the Optimization Algorithm in VLSI Design Problems	
3	Floorplanning Algorithms	
3.1	Floorplanning Concept	1
3.2	Optimization Problems in Floorplanning	2
3.3	Shape Function and Sizing	1
	Assignment II – Implement the Floorplanning Optimization Algorithm	
4	Routing Algorithms	
4.1	Local Routing Problems	1
4.2	Area Routing	1
4.3	Channel Routing	3
4.4	Global Routing	2
4.5	Algorithms for Global Routing	2
	Assignment III – Analyse the different routing algorithms in VLSI Circuits	
5	Logic Synthesis and Verification	
5.1	Combinational Logic Synthesis	1
5.2	Binary Decision Diagrams	1
5.2.1	ROBDD principles	1
5.2.2	ROBDD Manipulation	1

5.2.3	Variable Ordering	1
5.3	Two Level Logic Synthesis	2
	Total	36

Course Designers:

1.	Dr.S.Rajaram	rajaram_siva@tce.edu
2.	Dr.D.Gracia Nirmala Rani	gracia@tce.edu



14ECRM0	IMAGE ANALYSIS AND VISUALIZATION	Category	L	T	P	Credit
		PE	3	0	0	3

Preamble

This course introduces fundamental concepts and techniques for image analysis and visualisation as an extension of image processing. Image Analysis has become ubiquitous in our society, with applications in search, image understanding, apps, mapping, medicine, drones, and self-driving cars. Visual analysis tasks such as image detection, localization, classification and Image analysis will offer a more enriched learning experience on fundamental concepts and techniques. It aims to provide technology-oriented students with the knowledge and ability to develop creative solutions, and better understand the effects of future developments of image Analysis on people and society. This course will address how efficiently image can be processed, transformed, restored, classified and visualized with specific applications.

Prerequisite

14EC570 Image Processing

Course outcomes

On the successful completion of the course, students will be able to

CO1.	Examine different transforms and analyse their merits and demerits with specific image processing applications.	Analyse
CO2.	Apply various restoration techniques in spatial domain as well as in frequency domain for image enhancement.	Apply
CO3.	Select and apply deterministic or probabilistic classifiers for image analysis.	Apply
CO4.	Visualize the scenarios as 2D, 2.5D and 3D images.	Understand
CO5.	Compare image analysis techniques and classifiers for real world image processing applications	Analyse

Mapping with Programme Outcomes

COs	PO 1	PO 2	PO 3	PO 4	PO 5	PO 6	PO 7	PO 8	PO 9	PO 10	PO 11	PO 12	PSO 1	PSO 2	PSO 3
CO1	S	M	L	L	L	L	-	-	L	L	-	-	M	M	L
CO2	S	M	L	-	L	L	-	-	L	L	-	-	L	L	-
CO3	M	L	-	-	L	L	-	-	L	L	-	-	L	L	-
CO4	M	L	-	-	-	-	-	-	-	-	-	-	-	-	-
CO5	S	M	L	L	L	L	-	L	L	L	-	-	S	M	L

S- Strong; M-Medium; L-Low

Assessment Pattern

Bloom's Category	Continuous Assessment Tests			Terminal Examination
	1	2	3	
Remember	10	10	0	0
Understand	10	10	20	20
Apply	40	40	40	40
Analyse	40	40	40	40
Evaluate	0	0	0	0
Create	0	0	0	0

Course Level Assessment Questions

Course Outcome 1 (CO1):

1. Compute the Haar transform of the image $f(x,y) = [4 \ -1; \ 2 \ 3]$. Also, compute the inverse Haar transform for the obtained result.
2. Perform KL transform for the matrix $X = [4 \ -2; \ -1 \ 3]$;
3. Derive 1D and 2D continuous wavelet transform.
4. Write the equation for 2D radon transform and its inverse. Write any three applications of radon transform

Course Outcome 2 (CO2):

1. A blur filter $h(m,n)$ is given by $h(m,n) = [0 \ 0.1 \ 0.1 \ 0; \ 0.1 \ 0.1 \ 0.1 \ 0.1; \ 0.05 \ 0.1 \ 0.1 \ 0.05; \ 0 \ 0.05 \ 0.05 \ 0]$. Find the deblur filter using a) inverse filter b) pseudo-inverse filter approach with $\epsilon=0.05$, c) pseudo-inverse filter approach with $\epsilon=0.2$
2. A blur filter $h(m,n)$ is given by $h(m,n) = [0 \ 0.05 \ 0.05 \ 0; \ 0.15 \ 0.1 \ 0.1 \ 0.15; \ 0 \ 0.1 \ 0.1 \ 0; \ 0 \ 0.1 \ 0.1 \ 0]$. Find the deblur filter using a) Wiener filter with $\sigma_x^2 = 200$ and $\sigma_w^2 = 100$.
3. Distinguish between stochastic and deterministic methods of image restoration.
4. Illustrate, how you will locate feature in one image that appear in another using correlation.

Course Outcome 3 (CO3):

1. Distinguish between deterministic and stochastic classifiers.
2. Derive the gradient for stochastic gradient descent and utilize it for logistic regression.
3. Illustrate Random forest classifier with intermediate steps to.
4. Define KNN classifier and list some of its applications.

Course Outcome 4 (CO4):

1. Describe 3D scene model using different cameras with perspective projection.
2. Model 2.5D scene using different cameras with ambient illumination and orthographic projection.
3. Draw the projection of 2D motion model relating 2D and 3d motion vectors.
4. In what type of visualisation 2D/3D will be better. List some of the pros and cons of 3D.

Course Outcome 5 (CO5):

1. How will you identify the structure and geometry of linear textile fabrics
2. Classify images using Local Naive Bayes Nearest Neighbour.
3. Segment the flowers in the plant image using thresholding, apply GLCM for feature extraction and finally compute Eucledian distance for classifying flower using knn classifier.
4. List some of the applications of 3D visualisation.

Concept Map

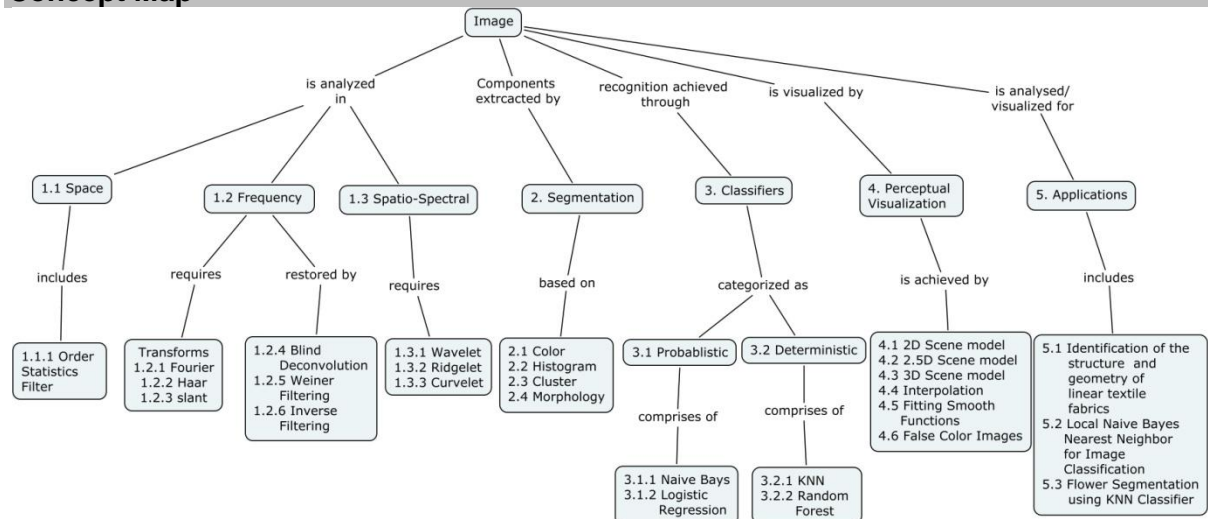

Syllabus

Introduction to Image Analysis and Image Transforms: Introduction to Image Analysis and Visualisation, Course Objective and Outcomes, Review on Image Processing, **Space-** Order Statistics Filter, Frequency- Image Transforms– Fourier, Haar, Slant, Wavelet,

Restoration-Blind Deconvolution, Weiner Filtering, Inverse Filtering, Spatio-Spectral-Wavelet, Ridgelet, Curvelet

Segmentation: Color, Histogram, Cluster and Morphology based segmentation

Classification: Probabilistic Classifiers - Navie Bayes Classifier, Logistic Regression, Deterministic Classifiers - KNN Classifier and Random Forests Classifier.

Perceptual visualization: 2D Scene Model, 2.5 D Scene Model, 3D Scene Model and Role of 2D /3D in Visualization

Applications - Identification of the structure and geometry of linear textile fabrics, Local Naive Bayes Nearest Neighbor for Image Classification and Flower Segmentation using KNN Classifier

Text Book

1. R. C. Gonzalez and R. E. Woods, Digital Image Processing, 3rd edition, Prentice Hall, 2008.
2. Yao Wang, Jorn Ostermann, and Ya-Qin Zhang, Video Processing and Communications, Prentice-Hall, ISBN 0-13-017547-1

Reference Books and Resources

1. A.K.Jain, Fundamentals of Digital Image Processing, Prentice-Hall, 1989.
2. A.Bovik, ed., The Essential Guide to Image Processing, Academic Press, 2009.
3. R.C. Gonzalez, R.E. Woods, S.L. Eddins, Digital Image Processing using MATLAB, Prentice-Hall, 2004, ISBN 0-13-008519-7.
4. W. Pratt, *Digital Image Processing*, 3rd edition, John Wiley & Sons, 2001, ISBN 0-471-37407-5.

Course Contents and Lecture Schedule

No.	Topic	No. of Lectures
1	Introduction to Image Analysis and Image Transforms	
	Introduction to Image Analysis and Visualisation, Course Objective and Outcomes	1
	Review on Image Processing	1
1.1	Space	
1.1.1	Order Statistics Filter	1
1.2	Frequency	
1.2.1	Fourier	1
1.2.2	Haar	2
1.2.3	Slant	1
1.2.4	Blind Deconvolution	1
1.2.5	Weiner Filtering	2
1.2.6	Inverse Filtering	1
1.3	Spatio-Spectral	
1.3.1	Wavelet	1
1.3.2	Ridgelet	1
1.3.3	Curvelet	1
2	Segmentation	
2.1	Color	1
2.2	Histogram	1
2.3	Cluster	2
2.4	Morphology	2
3	Classification	
3.1	Probabilistic Classifiers	1

3.1.1	Navie Bayes Classifier	
3.1.2	Logistic Regression	1
3.2	Deterministic Classifier	2
3.2.1	KNN Classifier	
3.2.2	Random Forests Classifier	1
4	Perceptual Visualization	
4.1	2D Scene Model	1
4.2	2.5 D Scene Model	1
4.3	3D Scene Model, Role of 2D /3D in Visualization	1
4.4	Interpolation	1
4.5	Fitting smooth functions to sparse data, least-squares	1
4.6	False Color Images	1
5	Applications	
5.1	Identification of the structure and geometry of linear textile fabrics	1
5.2	Local Naive Bayes Nearest Neighbor for Image Classification	2
5.3	Flower Segmentation using KNN Classifier	2
	Total	36

Course Designers:

1.	Dr.S.Md. Mansoor Roomi	smmroomi@tce.edu
----	------------------------	------------------



14EC2A0	DEVICE CHARACTERIZATION	Category	L	T	P	Credit
		PE	1	0	1	2

Preamble

The purpose of this course is to enhance student's knowledge and educate about the Basics of Device Characterization and Modeling..

Prerequisite

Nil

Course Outcomes

On the successful completion of the course, students will be able to

CO1.	Explain the basics of IV measurement	Understand
CO2.	Carry out Advanced IV and CV measurements	Apply
CO3.	Explain Nano device measurements	Understand
CO4.	Explain basics of Device modelling	Understand

Assessment Pattern

- Objective type written exam at the end of the course
- DuT will be given to students to perform practical measurements, approach, technique and the process to perform measurement will be examined

Syllabus

Understanding Basics of IV: IV measurement basics, Low current measurement techniques, Understanding of Basics SMU's and Parametric Analyzer, Performing basic measurement using SMU on basic devices like diode, resistor. **Understanding of Advanced IV Measurement and CV Measurement:** Understanding of semiconductor process, Understanding of performing CV measurements, Performing IV and CV measurements on MOSFETs and BJT devices. **Understanding of Nano Device Measurements:** New trends and technology developing in semiconductor industry, Need of performing the pulsed IV measurements, Challenges involved in performing nano device measurements, Nano device probing challenges, Performing advanced measurements on MOSFETs. **Understanding basics of Device Modeling:** Device Modelling Requirements, Device Modeling Challenges, Device Modeling Tools and Techniques, Introduction to IC-CAP Device Modeling software.

Reference Books and Resources

26. The Parametric Measurement Handbook from Keysight Technologies
27. Keysight Technologies Educators Corner.
28. Keysight Technologies and Academia

Course Contents and Lecture Schedule

No.	Topic	No. of Lectures
1	Understanding Basics of IV	
1.1	IV measurement basics	1
1.2	Low current measurement techniques	1
1.3	Understanding of Basics SMU's and Parametric Analyzer	1
1.4	Performing basic measurement using SMU on basic devices like diode, resistor	2
2	Understanding of Advanced IV Measurement and CV Measurement	
2.1	Understanding of semiconductor process	2
2.2	Understanding of performing CV measurements	2
2.3	Performing IV and CV measurements on MOSFETs and BJT devices	2
3	Understanding of Nano Device Measurements	
3.1	New trends and technology developing in semiconductor industry	1
3.2	Need of performing the pulsed IV measurements	1
3.3	Challenges involved in performing nano device measurements	2
3.4	Nano device probing challenges	2
3.5	Performing advanced measurements on MOSFETs	1
4	Understanding basics of Device Modeling	
4.1	Device Modelling Requirements	1
4.2	Device Modeling Challenges	2
4.3	Device Modeling Tools and Techniques	2
4.4	Introduction to IC-CAP Device Modeling software	1
	Total	24

Course Designer:

2.	Mr.V.V. Pathy	pathiyer@keysight.com
3.	Dr.S.Rajaram	rajaram_siva@tce.edu
4.	Dr.N.B.Balamruga	nbbalamurgan@tce.edu

14EC2B0	SEMICONDUCTOR MODELING	Category	L	T	P	Credit
		PE	1	0	1	2

Preamble

The purpose of this course is to enhance student's knowledge and educate about the basics of device characterization and modeling.

Prerequisite

Nil

Course Outcomes

On the successful completion of the course, students will be able to

CO1.	Understand various foundry technologies	Understand
CO2.	Programme using AEL	Understand
CO3.	Develop front to back end PDK	Apply
CO4.	Develop DFM solutions in ADS and EM	Apply

Assessment Pattern

Objective type written exam at the end of the course

Syllabus

Foundry Technologies: Introduction to different foundry technologies (SiCMOS, SiGe, GaAs, GaN, InP, IPD), Overview of MMIC Fabrication techniques, Design flows and overview of keysight EEsof products, Brief about ADS, Introduction to PDK and overview of typical ADS PDK features. **Programming using AEL:** Introduction to AEL and Programming using AEL, Lab1: programming in AEL, Front to back end PDK, PDK structure, Front to back end PDK development, Create basic definition files, How to make a foundry specific netlist include component, Create netlist files for simulation, PDK Development, **Front to back end PDK (continued):** Writing layout Macros's : Example of FET artwork, Install design kit, Design kit verification, Debugging AEL code, Lab2:Hand on PDK development (code writing and debugging). **DFM solution in ADS and EM:** DFM solution in ADS, DRC – rule deck development using AEL, LVS – rule deck development using AEL, Lab3: Hands on writing on device recognition, parameter call backs for a device and creating DRC rules, Substrate stack up creation, EM co-sim using nonlinear demo kit, Lab4:Hands on creating substrate stack up.

Reference Books and Resources

29. The Parametric Measurement Handbook from Keysight Technologies
30. Keysight Technologies Educators Corner.
31. Keysight Technologies and Academia

Course Contents and Lecture Schedule

No.	Topic	No. of Lectures
1	Foundary Technologies	
1.1	Introduction to different foundary technologies (SiCMOS, SiGe, GaAs, GaN, InP, IPD)	1
1.2	Overview of MMIC Fabrication techniques	1
1.3	Design flows and overview of keysight EEsof products	1
1.4	Brief about ADS	1
1.5	Introduction to PDK and overview of typical ADS PDK features	1
2	Programming using AEL	
2.1	Introduction to AEL and Programming using AEL	1
2.1.1	Lab1: programming in AEL	1
2.2	Front to back end PDK	1
2.2.1	PDK structure	1
2.2.2	Front to back end PDK development	1
2.2.2.1	Create basic definition files	1
2.2.2.2	How to make a foundary specific netlist include component	1
2.2.2.3	Create netlist files for simulation	1
3	PDK Development	
3.1	Front to back end PDK (conmtined)	1
3.1.1	Writing layout Macros's : Example of FET artwork	1
3.1.2	Install design kit	1
3.2	Design kit verification	1
3.3	Debugging AEL code	1
3.4	Lab2:Hand on PDK development (code writing and debugging)	1
4	DFM solution in ADS and EM	
4.1	DFM solution in ADS	1
4.1.1	DRC – rule deck development using AEL	1
4.1.2	LVS – rule deck development using AEL	1
4.1.3	Lab3: Hands on writing on device recognition, parameter call backs for a device and creating DRC rules	1
4.2	Substrate stack up creation	1
4.3	EM co-sim using nonlinear demo kit	1
4.4	Lab4:Hands on creating substrate stack up	1
	Total	24

Course Designers:

1.	Mr.V.V. Pathy	pathyiver@keysight.com
2.	Dr.S.Raju	venthiru@tce.edu

14EC2C0	RF DESIGN AND MEASUREMENT TOOLS	Category	L	T	P	Credit
		PE	1	0	1	2

Preamble

The purpose of this course is to enhance student's knowledge and educate about the RF components, subsystems and system level testing.

Prerequisite

Nil

Course Outcomes

On the successful completion of the course, students will be able to

CO1.	Understand the fundamentals of communication	Understand
CO2.	Capturing and analyzing the signals	Understand
CO3.	Design and simulation of basic RF components using ADS	Apply

Assessment Pattern

- Objective type written exam at the end of the course
- DuT will be given to students to perform practical measurements, approach, technique and the process to perform measurement will be examined

Syllabus

Design and Simulation of Basic RF Components using ADS:Basics of RF simulation tool, Understanding of various simulation engines, Linear, non-linear and EM simulator, Design and simulation of filters, couplers, antennas and amplifiers, Hands on training on ADS simulation tool. **Fundamentals of Communication:** Understanding of basic modulation, Fundamentals of digital and wireless communication standards, Understanding of flow of modulated signal through transmitter and receiver blocks, Understanding of channel impairments on modulation quality, Understanding of EVM, BER, phase/amplitude error, offset error. **Capturing and Analyzing the Signals:** Capturing and recording of signals, with proper triggering techniques, Record and play signals for offline signal analysis. Capturing the signal of interest in presence of multiple signals, Understanding the selection of signal analysis tools depending upon the signals available, Understanding of digital receiver and challenges involved in testing.

Reference Books and Resources

32. Simon Haykin, "Communication systems" John Wiley & Sons, Fourth Edition, 2006
33. B.P.Lathi and Zhiding, "Modern digital and Analog Communication systems" John Wiley & Sons, Fourth Edition, 2006
34. ---"The Advanced Design System(ADS) Cookbook" Keysight Technologies educator's corner

Course Contents and Lecture Schedule

No.	Topic	No. of Lectures
1	Design and Simulation of Basic RF Components using ADS	
1.1	Basics of RF simulation tool	2
1.2	Understanding of various simulation engines	2
1.3	Linear, non-linear and EM simulator	2
1.4	Design and simulation of filters, couplers, antennas and amplifiers	2
1.5	Hands on training on ADS simulation tool	2
2	Fundamentals of Communication	

2.1	Understanding of basic modulation	1
2.1.1	Fundamentals of digital and wireless communication standards	2
2.2	Understanding of flow of modulated signal through transmitter and receiver blocks	2
2.2.1	Understanding of channel impairments on modulation quality	2
2.2.2	Understanding of EVM, BER, phase/amplitude error, offset error	2
3	Capturing and Analyzing the Signals	
3.1	Capturing and recording of signals, with proper triggering techniques	1
3.2	Record and play signals for offline signal analysis	1
3.3	Capturing the signal of interest in presence of multiple signals	1
3.4	Understanding the selection of signal analysis tools depending upon the signals available	1
3.5	Understanding of digital receiver and challenges involved in testing	1
	Total	24

Course Designer:

1.	Mr.V.V. Pathy	pathyiyer@keysight.com
2.	Dr.S.Raju	rajuabhai@tce.edu
3.	Dr.S.J. Thiruvengadam	sitece@tce.edu



NEW GENERAL ELECTIVE COURSES

- 1. 14ECGA0 – Consumer Electronics**
- 2. 14ECGB0 – Multimedia Systems**
- 3. 14ECGC0 – Telecom Systems**
- 4. 14ECGD0 – Image Processing and Applications**

FOR

B.E. / B.Tech. DEGREE PROGRAMMES

(Department of Electronics and Communication Engineering)



**FOR THE STUDENTS ADMITTED IN THE
ACADEMIC YEAR 2014-15 ONWARDS**

**DEPARTMENT OF ELECTRONICS AND COMMUNICATION
ENGINEERING
THIAGARAJAR COLLEGE OF ENGINEERING**

(A Government Aided ISO 9001:2008 certified Autonomous Institution affiliated to Anna University)
MADURAI – 625 015, TAMILNADU

Phone: 0452 – 2482240, 41

Fax: 0452 2483427

Web: www.tce.edu

14ECGA0	CONSUMER ELECTRONICS	Category	L	T	P	Credit
		PE	3	0	0	3

Preamble

The consumer electronics market is flooded with new products with the number of new consumer devices due to the digitization of technology both products and media has led to leaps in product development. It has enabled easier exchange of media, cheaper and more reliable products, and convenient services

This course aim at understanding various of various electronics audio video systems, loud speakers and audio players, smart office / digital home systems, automotive entertainment devices and digital consumer devices and their related applications.

Prerequisite

NIL

Course Outcomes

On the successful completion of the course, students will be able to

CO1	Explain about various electronic audio devices and systems	Understand
CO2	Explain about various electronic video devices and systems	Understand
CO3	Describe various display technologies and digital storage	Understand
CO4	Understand working principle and main feature of smart office and digital home systems	Understand
CO5	Construct automotive and consumer electronic circuits	Apply

Mapping with Programme Outcomes

Cos	PO1	PO2	PO3	PO4	PO5	PO6	PO7	PO8	PO9	PO10	PO11	PO12
CO1	S	M	-	-	M	M	M	M	-	-	-	M
CO2	S	S	M	M	M	-	M	-	-	-	-	M
CO3	S	S	M	M	M	M	L	L	-	-	-	M
CO4	S	S	M	M	M	-	M	-	-	-	-	M
CO5	S	S	M	M	M	M	L	L	-	-	-	M

S- Strong; M-Medium; L-Low

Assessment Pattern

Bloom's category	Continuous Assessment Tests			End Semester Examination
	1	2	3	
Remember	20	20	0	0
Understand	60	60	80	80
Apply	20	20	20	20
Analyze	0	0	0	0
Evaluate	0	0	0	0
Create	0	0	0	0

Course Level Assessment Questions**Course Outcome 1 (CO1):**

1. Define principle of micro phone and loud speaker system.
2. Discuss the principle of digital audio players
3. List the various standards of television systems.
4. Discuss filed emission display

Course Outcome 2 (CO2):

1. Discuss direct radiating loud speaker and horn loaded woofer
2. Describe residential gate ways and IVRS
3. Explain set top box, DTH and Home theatre system.

Course Outcome 3(CO3):

1. Explain plasma address display system.
2. Describe LED/LCD display system.
3. Discuss about 3D-display system.

Course Outcome 4(CO4):

1. Explain the concept of Smart Phones.
2. Discuss about Screenphone.
3. Describe in detail about PDA and Smart Card Reader,

Course Outcome 5(CO5):

1. Construct and illustrate various Electronics systems in Automobiles
2. Design in-vehicle Multimedia system.
3. Illustrate and describe GPS used in automobiles.

Concept Map

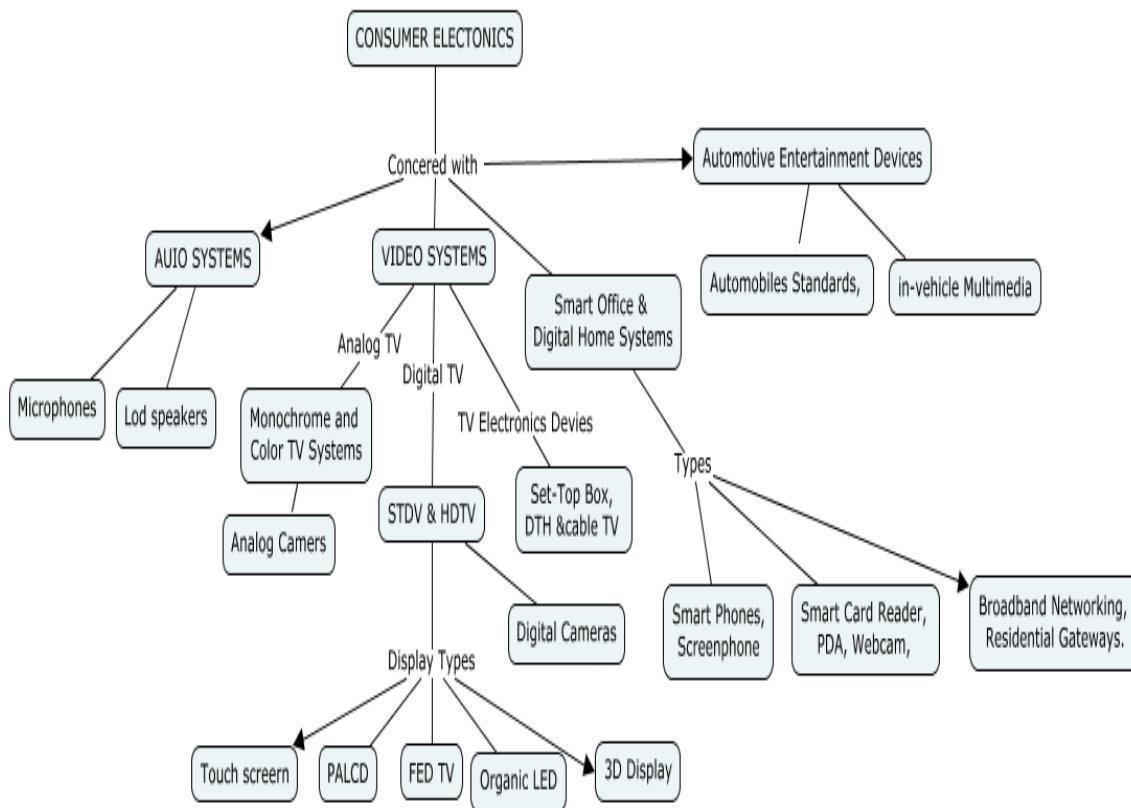

Syllabus

Audio system: Microphones, Loudspeaker and Audio Players: Introduction to microphones and types baffles. Ideal loudspeaker and its ranges, woofers, tweeters and equalizers. Digital Audio player, storage Audio formats, Internet Audio Formats, MP3 Portable Players, Internet Radio Digital Audio Radio Online Music Distribution. **Video Systems:** Black & White TV. Video transmitter and receiver. NTSC and PAL system. Digital TV System & Standards, SDTV and HDTVs, Set-top Boxes, Home Theatre, DTH Video Recorders, cable TV and cable TV in internet. LCD, Plasma, Plasma Addressed LCD (PALCD), Field Emission Displays (FEDs), Organic LEDs, LED Video, Liquid Crystal on Silicon, 3-D Displays ,

Touch-screen standards. Digital Still Cameras, Digital Video/Versatile Disc. **Smart Office & Digital Home Systems:** Smart Phones, Screenphone, PDA, Smart Card Reader, Webcam, Broadband Networking, Residential Gateways and IVRS. **Automotive Electronic:** Electronics in Automobiles, in-vehicle Multimedia.

Text Books:

1. Bali S.P, "Consumer Electronics", Pearson Education, 2008
2. The Digital Consumer Technology Handbook A Comprehensive Guide to Devices, Standards, Future Directions, and Programmable Logic Solutions by Amit Dhir Xilinx, Inc, Elsevier 2004.

Reference Book

1. R.R Gulati, "Colour Television-principles & practice", Wiley Eastern Limited, New Delhi, 2008

Course Contents and Lecture Schedule

Module No	Topic	No.of Lectures
1	Audio system	
1.1	Microphones: Introduction, characteristics of microphones,	3
1.2	types of microphone: carbon, moving coil, wireless, crystal,	2
1.3	Ideal loudspeaker and its ranges, baffles. woofers, tweeters and equalizers	2
1.4	Digital Audio player, storage Audio formats, Internet Audio Formats,	2
1.5	MP3 Portable Players, Internet Radio Digital Audio Radio Online Music Distribution	2
2	Video Systems	
2.1	Black & White TV. Video transmitter and receiver.	2
2.2	NTSC and PAL system	1
2.3	Digital TV System & Standards, SDTV and HDTVs,	2
2.4	Set-top Boxes, Home Theatre, DTH Video Recorders,	
2.5	Cable TV and cable TV in internet. LCD, Plasma, Plasma Addressed LCD (PALCD),	2
2.6	Field Emission Displays (FEDs), Organic LEDs, LED Video, Liquid Crystal on Silicon, 3-D Displays ,	4
2.7	Touch-screen standards. Digital Still Cameras, Digital Video/Versatile Disc	2
3	Smart Office & Digital Home Systems	
3.1	Smart Phones, Screen phone,	2
3.2	PDA, Smart Card Reader,	2
3.3	Webcam, Broadband Networking	2
3.4	Residential Gateways and IVRS.	
4	Automotive Electronics	
4.1	Electronics in Automobiles	3
4.2	In-vehicle Multimedia.	3
	Total No. of Hours	36

Course Designers:

1.	Dr.K.Hariharan	khh@tce.edu
2.	Mr.M.Senthilnathan	msnece@tce.edu

14ECGB0	MULTIMEDIA SYSTEMS	Category	L	T	P	Credit
		PE	3	0	0	3

Preamble

Multimedia has become an indispensable part of modern computer technology. In this course, students will be introduced to principles and current technologies of multimedia systems. Issues in effectively representing, processing, and retrieving multimedia data such as sound and music, graphics, image and video will be addressed. Latest Web technologies and some advanced topics in current multimedia research will also be discussed.

Prerequisite

NIL

Course Outcomes

On the successful completion of the course, students will be able to

CO1. state the properties of different media streams; compare and contrast different network protocols	Remember
CO2. understand the structure of the tools in the light of low-level constraints imposed by the adoption of various QoS schemes	Understand
CO3. describe mechanisms for providing QoS guarantees in the network	Understand
CO4. understand the effects of scale and use on both presentation and lower-level requirements	Apply
CO5 realise different multimedia tools and the way in which they are used	Analyze

Mapping with Programme Outcomes

COs	PO1	PO2	PO3	PO4	PO5	PO6	PO7	PO8	PO9	PO10	PO11	PO12
CO1	M	M	L	L	L	L	-	L	-	-	-	-
CO2	S	M	L	-	L	-	-	L	-	L	-	-
CO3	S	M	L	L	L	-	-	L	L	L	-	-
CO4	S	S	S	-	S	-	-	L	-	L	-	-
CO5	S	S	L	L	L	L	-	L	M	-	-	L

S- Strong; M-Medium; L-Low

Assessment Pattern

Bloom's Category	Continuous Assessment Tests			Terminal Examination
	1	2	3	
Remember	30	0	0	0
Understand	30	40	30	30
Apply	40	40	40	40
Analyse	0	20	30	30
Evaluate	0	0	0	0
Create	0	0	0	0

Course Level Assessment Questions**Course Outcome 1(CO1):**

1. State the basic form of representation of: text, an image, audio, video. State the form of representation that is used when all are integrated together and give your reason.
2. State the meaning of the term "bits per second" in relation to digitized audio and video. What is the meaning of the term "compression" and why is compression used?
3. State the meaning of the term "dynamic range" as applied to an analog signal and show how this is expressed in decibels. How does this influence the number of bits to be used for the quantizer part of an ADC?

4. State the meaning of the term “composite video signal” and with the aid of a diagram, describe how the two colour difference signals are transmitted within the same frequency band as that used for the luminance signal.
5. State the characteristic of the eye that is exploited in the quantization phase of the JPEG algorithm.
6. State the characteristics of the values in the quantization coefficient matrix that are exploited during the entropy encoding stage. Why is vectoring using a zig-zag scan applied to the matrix?
7. State how the compression algorithm used with MPEG-1 differs from that used in the H.261 standard.

Course Outcome 2 and 3(CO2 and CO3):

1. Explain why a pair of modems is required to transmit a digital signal over a PSTN. With the aid of a diagram, show the location of the two modems when two digital devices communicate over a PSTN and the types of signal analog or digital –that are used over each part of the access circuit.
2. Explain why most data networks operate in a packet mode. Hence explain why services involving audio and video are supported.
3. With the aid of a diagram, explain the function of a telephony gateway in relation to internet telephony. Hence state the origin of the term “voice over IP” (VoIP).
4. Explain the role of an MCU in relation to a videoconferencing session involving multiple geographically distributed videoconferencing studio. Quantify the bandwidth implications of locating the MCU at one of the sites.
5. Identify and explain the meaning of the key QoS parameters associated with the following network types:
 - (i) Circuit-switched
 - (ii) Packet-switched
6. With the aid of a set of signal waveforms, show the principles of how a time-varying analog signal is made up of a range of sinusoidal frequency components of differing amplitude and phase relative to one another.
7. With the aid of a diagram, identify and explain the role of the following relating to e-commerce over the internet: (i) forms (ii) CGI script (iii) encryption (iv) submit button.
8. Explain the following relating to the CIF and QCIF formats of H.261 encoding standards: (i) horizontal and vertical resolution in pixels (ii) the number of macroblocks per frame.

Course Outcome 4(CO4):

1. A digitized video is to be compressed using the MPEG-1 standard. Assuming a frame sequence of
 IBBPBBPBBPBBI.....
 and average compression ratio of 10:1 (I), 20:1 (P) and 50:1 (B), derive the average bit rate that is generated by the encoder for both the NTSC and PAL digitization formats.
2. A statistical encoding algorithm is being considered for the transmission of a large number of long text files over a public network. Analysis of the file contents has shown that each file comprises only the six different characters M,F,Y,N,0 and 1 each of which occurs with a relative frequency of occurrence of 0.25, 0.25, 0.125,0.125, 0.125 and 0.125 respectively. If the encoding algorithm under consideration uses the following set of codewords:
 M=10, F=11, Y=010, N=011, 0=000, 1=001
 Compute:
 - (i) the average number of bits per codeword with the algorithm
 - (ii) the entropy of the source
 - (iii) the minimum number of bits required assuming fixed-length codewords.

3. Assuming a quantization threshold value of 16, derive the resulting quantization error for each of the following DCT coefficients:
127, 72, 64, 56, -56, -64, -72, -128.
 4. Determine the encoded version of the following difference values which relate to the encoded DC coefficients from consecutive DCT blocks
12, 1,-2, 0,-1
 5. Derive the binary form of the following run-length encoded AC coefficients:
(0,6) (0,7) (3,3) (0,-1) (0,0)
- Determine the Huffman-encoded version of the following difference values which relate to the encoded DCT coefficients from consecutive DCT blocks.
12,1,-2,0,-1

Use the default Huffman codewords defined below:

Number of bits needed (SSS)	Huffman codeword
0	010
1	011
2	100
3	00
4	101
5	110
6	1110
7	11110
:	:
11	11111110

6. Determine the rate of the sampler and the bandwidth of the bandlimiting filter in an encoder which is to be used for the digitization of an analog signal which has a bandwidth from 15Hz through to 10kHz assuming the digitized signal:
 - (i) Is to be stored within the memory of a computer
 - (ii) Is to be transmitted over a channel which has a bandwidth from 200Hz through to 3.4kHz.
7. An analog signal has a dynamic range of 40 dB. Determine the magnitude of the quantization noise relative to the minimum signal amplitude if the quantizer uses (i) 6 bits and (ii) 10 bits.

Course Outcome 5(CO5):

1. Derive the time to transmit the following digitized images at both 64kbps and 1.5 Mbps:
 - a 640 x 480 x 8 VGA-compatible image
 - a 1024 x 768 x 24 SVGA- compatible image.
2. Assuming the bandwidth of a speech signal is from 50Hz through to 10kHz and that of a music signal is from 15Hz through to 20 kHz, derive the bit rate that is generated by the digitization procedure in each case assuming the Nyquist sampling rate is used with 12 bits per sample for the speech signal and 16 bits per sample for the music signal. Derive the memory required to store a 10 minutes passage of stereophonic music.
3. Derive the scaling factors used for both the *U* and *V* (as used in PAL) and *I* and *Q* (as used in NTSC) colour difference signals in terms of the three *R*, *G*, *B* colour signals.
4. Derive the maximum block size that should be used over a channel which has a mean BER probability of 10^{-4} if the probability of a block containing an error – and hence discarded – is to be 10^{-1} .

5. A packet-switched network with a worst-case jitter of 10ms is to be used for a number of applications each of which involves a constant bit rate information stream. Determine the minimum amount of memory that is required at the destination and a suitable packet size for each of the following input bit rates. It can be assumed that the mean packet transfer rate of the network exceeds the equivalent input bit rate in each case:

- (i) 64kbps
(ii) 256kbps
(iii) 1.5Mbps

Concept Map

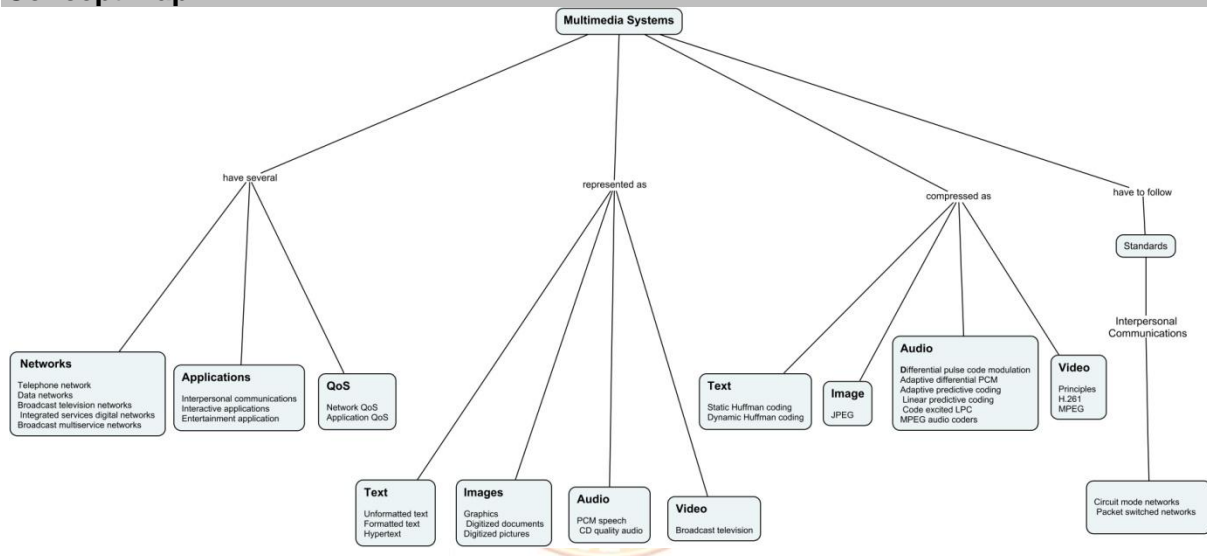

Syllabus

Multimedia communications: Introduction, Multimedia information representation, Multimedia networks-telephone networks, data networks, broadcast television networks, integrated services digital networks, broadcast multiservice networks. Multimedia applications- interpersonal communications, interactive applications over the internet, entertainment application. Applications and networking terminology- media types, communication modes, network types, network QoS, application QoS. **Multimedia information representation:** Introduction, Digitization principles- analog signals, encoder design, decoder design. Text- unformatted text, formatted text, hypertext. Images- graphics, digitized documents, digitized pictures. Audio-PCM speech, CD quality audio, Video- Broadcast television. **Text and image compression:** Introduction, Compression principles- source encoders and destination decoders, lossless and lossy compression, entropy encoding. Text compression- Static Huffman coding, Dynamic Huffman coding. Image compression – JPEG. **Audio and video compression:** Introduction, Audio compression- differential pulse code modulation, adaptive differential PCM, adaptive predictive coding, linear predictive coding, code excited LPC, MPEG audio coders, Video compression - Principles, H.261, MPEG. **Standards for multimedia communications:** Introduction, Reference models- TCP/IP reference model, protocol basics. Standards relating to interpersonal communications- circuit mode networks, packet switched networks.

Text Books

1. Fred Halsall, "Multimedia Communications: Applications, Networks, Protocols and Standards", Addison-Wesley, 2012
2. K. Rammohanarao, Z. S. Bolzkovic and D. A. Milanovic, "Multimedia Communication Systems", Prentice Hall, May 2013.

Reference Books:

1. Ze-Nian Li and Mark S. Drew, "Fundamentals of Multimedia", Pearson Prentice Hall, October 2011.

2. Yao Wang, Joern Ostermann, and Ya-Qin Zhang, "Video Processing and Communications", Prentice Hall, 2011.
3. Stephen McGloughlin, "Multimedia: Concepts and Practice", November 2000, Prentice Hall, 2012

Course Contents and Lecture Schedule

ModuleNo.	Topics	No of Lectures
1	Multimedia communications	
1.1	Introduction, Multimedia information representation	1
1.2	Multimedia networks-telephone networks, data networks, broadcast television networks, integrated services digital networks, broadcast multiservice networks.	2
1.3	Multimedia applications- interpersonal communications, interactive applications over the internet, entertainment application.	2
1.4	Applications and networking terminology- media types, communication modes, network types,	1
1.5	Network QoS, application QoS.	2
2	Multimedia information representation	
2.1	Introduction, Digitization principles- analog signals, encoder design, decoder design.	2
2.2	Text- unformatted text, formatted text, hypertext	2
2.3	Images- graphics, digitized documents, digitized pictures.	2
2.4	Audio-PCM speech, CD quality audio	1
2.5	Video- Broadcast television	1
3	Text and image compression	
3.1	Introduction, Compression principles-source encoders and destination decoders	1
3.2	lossless and lossy compression, entropy encoding	2
3.3	Text compression- Static Huffman coding, Dynamic Huffman coding	2
3.4	Image compression – JPEG.	2
4	Audio and video compression	
4.1	Introduction, Audio compression-differential pulse code modulation, adaptive differential PCM	2
4.1.1	adaptive predictive coding, linear predictive coding, code excited LPC	1
4.1.2	MPEG audio coders	2
4.2	Video compression - Principles, H.261,	2
4.2.1	MPEG.	1
5	Standards for multimedia communications	
5.1	Introduction	1
5.2	Reference models- TCP/IP reference model, protocol basics.	2
5.3	Standards relating to interpersonal communications-circuit mode networks, packet switched networks	2
	Total	36

Course Designer:

1	Dr.M.S.K.Manikandan	manimsk@tce.edu
---	---------------------	-----------------

14ECGC0	TELECOM SYSTEMS	Category	L	T	P	Credit
		PE	3	0	0	3

Preamble

The objective of this course is to introduce the concepts of digital communication systems, satellite communication systems, Radio Detection and Ranging (RADAR) systems and wireless communication systems & Standards. In this course, mathematical techniques have been kept relatively at modest level, making it accessible to any discipline of Engineering.

Prerequisite

NIL

Course Outcomes

On the successful completion of the course, students will be able to

CO1. Describe a simplified communication system model in terms of wavelength, frequency, RF spectrum, modulation and demodulation, signal to noise ratio, Decibel gain and loss ratios.	Understand
CO2. Describe the simplified communication system blocks used in Digital Communication, Radar Communication and Wireless Communication	Understand
CO3. Develop a communication link budget analysis and apply it to Radar systems.	Apply
CO4. Determine the signal to noise ratio (SNR) at the input of a digital communication receiver and SNR at the output of the detector.	Apply
CO5. Describe the general operation of Satellite communication system and determine the SNR for both the uplink and downlink	Apply
CO6. Describe the cellular concept of Wireless Communication Systems, 2G, 3G and 4G wireless standards for mobile communication, IEEE 802.11b, g Wireless Local area network (WLAN) standards.	Apply

Mapping with Programme Outcomes

COs	PO1	PO2	PO3	PO4	PO5	PO6	PO7	PO8	PO9	PO10	PO11	PO12
CO1.	S	-	-	M	-	-	-	M	-	M	-	M
CO2.	S	S	M	-	-	-	M	L	M	L	L	L
CO3.	S	S	M	L	-	-	-	L	L	L	-	L
CO4.	S	S	M	L	M	-	-	L	-	L	-	L
CO5.	S	S	M	L	L	L	-	L	-	L	-	L
CO6.	S	S	-	-	-	-	-	L	-	L	-	L

S- Strong; M-Medium; L-Low

Assessment Pattern

Bloom's Category	Continuous Assessment Tests			Terminal Examination
	1	2	3	
Remember	20	20	0	0
Understand	20	20	40	40
Apply	60	60	60	60
Analyse	0	0	0	0
Evaluate	0	0	0	0
Create	0	0	0	0

Course Level Assessment Questions

Course Outcome 1 (CO1):

1. Draw the block diagram of a simplified model of a communication system
2. Define the term co channel interference and adjacent channel interference.
3. What are the re-use factors for the wireless standards namely AMPS, GSM and IS-95 systems?
4. State μ - Compression Law
5. Define maximum usable frequency and minimum usable frequency of ionospheric layer.

Course Outcome 2 (CO2):

1. Distinguish between flat fading and frequency selective fading.
2. Distinguish between cochannel interference and adjacent channel interference
3. Distinguish between A-law and μ law companding.
4. What are the needs for modulation?
5. When the demand for wireless service increases, how is it possible to provide more channels per unit coverage area?

Course Outcome 3 (CO3):

1. A communication system has the following parameters:

$$P_t = 5 W$$

$$G_t(dB) = 13 dB$$

$$G_r(dB) = 17 dB$$

$$d = 80 km$$

$$f = 3 GHz$$



2. Determine the value of the receiver power using Friis transmission formula. A pulse radar system operates at a frequency of 10 GHz with a pulse repetition frequency of 2 kHz and a pulse width of 6 μ s. Determine (a) the maximum unambiguous range, and (b) the resolution or minimum range.
3. Determine the Instantaneous cyclic frequency of a Doppler RADAR transmitting a sinusoidal cyclic frequency f_c and radian frequency $\omega_c = 2\pi f_c$ leading to Doppler shift.
4. A Doppler radar operating at 10GHz is being used to measure the speed of an automobile moving directly toward it. The frequency shift is 3kHz. Determine the speed of the automobile in miles per hour.
5. An electromagnetic wave propagating in air encounters a boundary with a material having a dielectric constant of 8. The angle of incidence is 40°. Determine the angle of refraction.

Course Outcome 4 (CO4):

1. The cascade system has three components. (a) input line amplifier with power gain $G_1=5000$, (b) long transmission line with a power loss factor $L=2000$, and (c) load amplifier with an absolute power gain $G_2=400$. Impedances are matched at all junctions. Determine (i) net system absolute gain, (ii) system decibel gain using the result of (i), and (iii) system decibel gain from individual decibel values.
2. An analog system requires an antenna signal power of 50pW to meet the required signal to noise ratio. Other system parameters are given as follows: $G_t(dB) = 3dB, G_r(dB) = 4dB, f = 500MHz, d = 80km$. Assuming direct ray propagation, determine the minimum value of the transmitted power required.

3. Consider a PCM TDM system in which 19 signals are to be processed. Each of the signals has a baseband bandwidth $W = 5$ KHz, and 8 bits are to be used in each word. Conventional NRZ – L encoding will be used, and an additional 8 – bit sync word will be placed in each frame. Determine the theoretical minimum bandwidth required
4. Consider the bit stream 01001110. Sketch the forms for each of the following data formats: (i) NRZ-L (ii) NRZ-M (iii) NRZ-S (iv) RZ (v) biphas-L (vi) biphas-M (vii) biphas-S. For encoding schemes in which the initial level is arbitrary, assume a zero level just before the first bit is received.
5. In a binary digital communication system, the average signal carrier power at the antenna terminals of the receiver is 200 fW. The equivalent antenna noise temperature is 300 K, and the receiver effective noise temperature referred to the input is 425 K. Determine the detected output signal – to – noise ratio, for binary PCM transmission with 6 – bit words at a data rate of 2 Mbits/s, for (a) PSK with matched filter, (b) ASK with matched filter.
6. A bipolar analog signal is sampled at intervals of 1ms by a 4-bit A/D convertor. The voltage at the sampling points are provided in the table that follows, and the full scale voltage is 5V (based on a peak to peak range of 10V) Determine the 4-bit digital word that would be generated at each point.

Time(ms)	0	1	2	3	4	5	6
Value (V)	-4	-3	-2	0	2	3	4

Course Outcome 5 (CO5):

1. A satellite is to be placed in an orbit 1000 km above the earth’s surface. Determine (a) the required velocity, (b) the circumference of the rotation, and (c) the period of the rotation.
2. In a satellite communication system the uplink portion is analyzed. The output power of the ground transmitter is 200W. This power level is effectively increased in the direction of transmission by the ground antenna, which has a gain of 40dB. The transmitted signal is attenuated by a path loss of 200 dB. The receiver antenna gain is 20 dB. If the total noise level at the input to the satellite receiver is 8 dBf, determine the received signal – to noise-ratio in dB.
3. The lowest downlink frequency for C band is 3.7GHz. Consider a satellite transmitter operating at this frequency with the goal of providing coverage of the continental United States, which requires a 3 dB beamwidth of about 18° . Assuming an illumination efficiency of 70%, determine the diameter and the gain of the downlink antenna.

Course Outcome 6 (CO6):

1. Consider a transmitter which radiates a sinusoidal carrier frequency of 1850 MHz for a vehicle moving 60m/hr, Compute the received carrier frequency if the mobile is moving (i) Directly towards the transmitter (ii) Directly away from the transmitter, and in a direction which is perpendicular to the direction of arrival of the transmitter signal.
2. Explain the techniques that are intended to improve the coverage area and capacity of cellular system.
3. Illustrate the IEEE 802.11b Wireless Local area network (WLAN) standard in detail.

4. Explain in detail about Global system for mobile and also explain the Frame structure and signal Processing in GSM

Concept Map

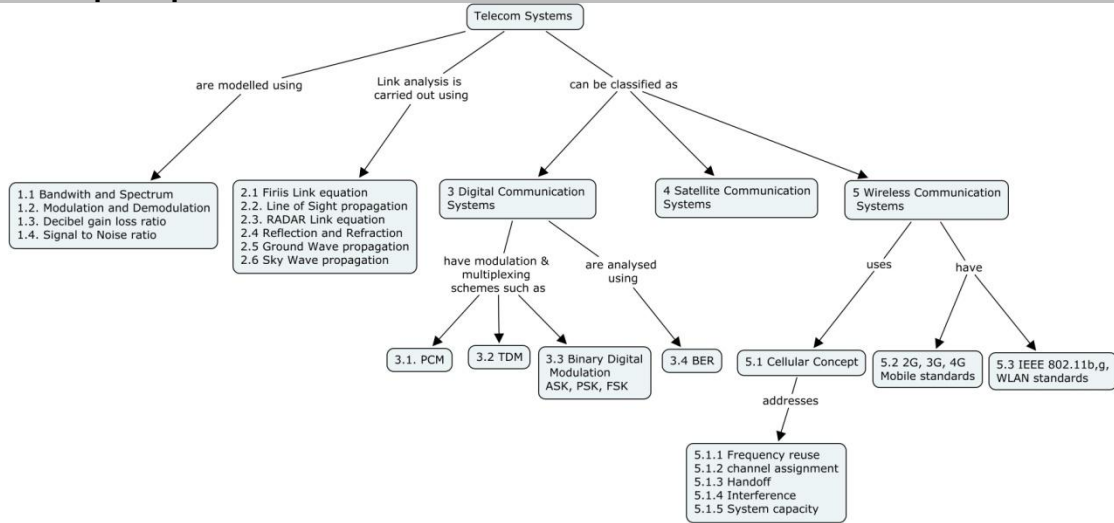

Syllabus

Introduction: Simplified Communication system model, Bandwidth and spectrum, modulation and demodulation, decibel gain and loss ratios, Signal to noise ratio and system level decibel analysis, **Communication Link Analysis:** Friis Link Equation, Decibel forms for the one way link equations, Line of Sight Propagation, Radar link equation, pulse radar, Doppler radar, Reflection and refraction, Ground wave propagation, Sky wave propagation **Digital Communication Systems: Pulse code modulation (PCM)**, basic PCM encoding and quantization, companding, baseband encoding forms, Time Division Multiplexing, Binary digital modulation schemes (ASK, PSK, FSK), Bit Error rate Analysis. **Satellite Communication Systems:** Orbital Mechanics, Satellite Alignment, Space craft communication Systems, Antennas Aboard Satellites and Earth Station, Satellite Link Analysis. **Wireless Communication Systems:** Cellular Concept: Frequency Reuse, Channel Assignment Strategies, Handoff Strategies, Interference, System Capacity, Wireless Standards: 2G, 3G and 4G Mobile Standards, IEEE 802.11b,g Wireless Local area network (WLAN) standards

Text Book

1. William D.Stanley and John.M. Jeffords, “ Electronic Communications Principles and Systems”, Cengage Learning, 2009 (India Edition)

Reference Books

1. Theddore S.Rappaport, “Wireless Communications: Principles and Practice”, Second Edition, PHI,2006
2. George Kennedy, “Electronic Communication Systems”, Tata McGraw Hill, Third Edition, 1996.
3. Wayne Tomasi, “ Advanced Electronic Communication Systems”, Prentice Hall International Inc., Fourth Edition, 1998

Course Contents and Lecture Schedule

Module No.	Topic	No. of Lectures
	Introduction to Telecom Systems	
1	Simplified Communication System Model	1
1.1	Bandwidth and Spectrum, Modulation and demodulation, decibel gain and loss ratios, Signal to noise ratio and system	1

Module No.	Topic	No. of Lectures
	level decibel analysis	
2	Communication Link Analysis:	
2.1	Friis Link Equation, Decibel forms for the one way link equations,	2
2.2	Line of Sight Propagation,	1
2.3	Radar link equation, Pulse radar, Doppler radar	2
2.4	Reflection and refraction	2
2.5	Ground wave propagation and Sky wave propagation	1
3	Digital Communication Systems:	
3.1	Pulse code modulation (PCM)	1
3.1.1	Basic PCM encoding and quantization,	2
3.1.2	Companding,	1
3.1.3	baseband encoding forms	2
3.2	Time Division Multiplexing	1
3.3	Binary digital modulation schemes (ASK, PSK, FSK)	2
3.4	Bit Error rate Analysis.	2
4	Satellite Communication Systems:	
4.1	Orbital Mechanics	1
4.2	Satellite Alignment	1
4.3	Space craft communication Systems, Antennas Aboard Satellites and Earth Station	1
4.5	Satellite Link Analysis	2
5	Wireless Communication Systems:	
5.1	Cellular Concept:	1
5.1.1	Frequency Reuse, Channel Assignment Strategies	2
5.1.3.	Handoff Strategies, Interference	2
5.1.5	System Capacity	1
5.2	Wireless Standards: 2G, 3G and 4G Mobile Standards	2
5.3	IEEE 802.11b, g Wireless Local area network (WLAN) standards	2
	Total Number of Hours	36

Course Designers:

1.	Dr.V.N.Senthil Kumaran	vnsenthilkumaran@tce.edu
----	------------------------	--------------------------

14ECGD0	IMAGE PROCESSING AND APPLICATIONS	Category	L	T	P	Credit
		PE	3	0	0	3

Preamble

The purpose of this course is to provide the basic concepts and methodologies for Digital Image Processing in three different levels. This course is specifically designed to provide interdisciplinary skill which includes CSE, EEE, MECH, CIVIL and IT disciplines to develop solutions for real world image processing applications. At the lowest level, the course introduces the terminology of image processing, how digital images are acquired, how the data is stored, image formats; relationship between pixels and spatial & frequency domain concepts for enhancement. In the middle level, it addresses how the algorithm utilizes low level results for the next level processes such as extracting useful information and morphological processing. At highest level, it addresses how the algorithm attempts to extract the semantic information (representors and descriptors) from those provided by the lower levels for real world image processing applications.

Prerequisite

NIL

Course Outcomes

On the successful completion of the course, students will be able to

CO1.	Demonstrate how digital images are acquired, stored and relationship between pixels	Understand
CO2.	Perform techniques to enhance of contrast and thereby improve the visual perception of contrast degraded imagery.	Apply
CO3.	Remove noise from real-world imagery using a variety of filtering techniques in both the spatial and frequency domain.	Apply
CO4.	Detect/Extract regions of interest from an image using various segmentation, representation, Description techniques and employ morphological algorithm to clean up and cluster such regions for further analysis.	Apply
CO5.	Identify and apply these techniques to solve real-world image processing problems and propose solutions for the same.	Analyze

Mapping with Programme Outcomes

COs	PO1	PO2	PO3	PO4	PO5	PO6	PO7	PO8	PO9	PO10	PO11	PO12
1.	L	L	-	L	-	L	L	S	L	L	-	L
2.	M	M	L	L	M	M	L	M	M	M	-	M
3.	M	L	-	-	M	L	-	L	L	L	-	L
4.	M	M	L	L	M	M	L	M	L	L	M	L
5.	S	S	S	S	M	S	M	S	M	M	S	M

S- Strong; M-Medium; L-Low

Assessment Pattern

Bloom's Category	Continuous Assessment Tests			Terminal Examination
	1	2	3	
Remember	20	20	0	0
Understand	20	20	20	20
Apply	60	60	60	60
Analyse	0	0	20	20
Evaluate	0	0	0	0
Create	0	0	0	0

Course Level Assessment Questions**Course Outcome 1 (CO1):**

1. Write digital image model and list different imaging sensors.
2. Distinguish CT and MRI imaging techniques and List the Pros and Cons.
3. If the intensity values of $f(x, y)$ are available at (11, 4) and (6, 9), find Euclidean Distance, chess board distance between these two pixels.
4. Explain two dimensional sampling (down sample to 2X2) and 4 bit (16 gray levels) quantization for the following 8 bit sub image and state the reasons for the effects due to these processes?

255	255	255	255	255	255	255	255
255	200	255	150	255	50	50	255
255	200	255	150	255	50	50	255
255	200	255	150	255	50	50	255
255	200	255	150	255	50	50	255
255	200	255	150	255	50	50	255
255	200	255	150	255	50	50	255
255	255	255	255	255	255	255	255

Course Outcome 2 (CO2):

1. Justify whether the image is poor in contrast. Identify the category of contrast. Is there any possibility to apply histogram equalization for the enhancement? If Yes, Justify and apply Histogram equalization for the following 6 bit image segment of size 6X6? Write the inference on image segment before and after equalization.

35	55	60	55	40	60
55	35	35	60	60	52
60	48	45	55	38	48
51	40	60	45	40	40
49	40	60	35	35	55
62	48	55	62	45	35

2. Demonstrate the following gray-level transformations for image enhancement via
 - i) Gamma correction
 - ii) Gray level slicing
 - iii) Contrast Stretching
3. Using bit plane coding if you display only MSB bits can you identify the image segment. Justify your answer.
4. Sketch histogram for dark and high contrast images.

Course Outcome 3 (CO3):

1. How order statistics filters are used to remove impulse, Gaussian and uniform noise?
2. Illustrate how smoothing of images can be carried out in frequency domain.
3. Compute Fourier Transform and its inverse for the following image data. [200 20; 200] [2x2] matrix. If phase of the given image matrix and magnitude of other image matrix is available can you recover original image?
4. Give the PDF of salt and pepper noise and sketch the PDF.

Course Outcome 4 (CO4):

1. The region-growing algorithm starts with a seed pixel. Suggest a way or gray level range to choose the seed pixel for the following two applications.
 - a. Segmenting the fractured portion of a leg in a X-Ray image
 - b. Segmenting defective welds for an image captured in industry

Syllabus

Imaging Technologies: Introduction to Image processing, it's need and applications - Image sensing and acquisition- CCD, CMOS, X-Ray, CT, MRI, Ultrasound, SAR, IR, Thermal- Imaging Components of an Image processing system.

Digital Image Model: Illuminance and Reflectance: Image formats, Image Sampling and Quantization –Basic relationship between pixels- Connectivity and Distance measures.

Image Enhancement: Noise models – Gaussian, Uniform salt and pepper noise-Gray level Transformations – Histogram processing – Fourier- Discrete cosine Transform –Spatial and Frequency domain filtering – smoothing, sharpening filters.

Segmentation: Thresholding –Threshold selection- Point, Line and Edge detection, Laplacian Mask- Edge linking - Region based segmentation – Region growing– Region splitting & merging

Representation and Description: Chain codes–Boundary descriptors –Regional Descriptors – Texture –Morphology - dilation and erosion – opening and closing.

Real World Applications: License plate detection, Missing component detection for automatic industry inspection, X-ray, CT, MRI Ultra sound image analysis for abnormality detection, Fault analysis in power system, Remote sensing- change detection, building, road extraction in satellite images, Digital image watermarking.

Text Books

1. Rafael.C.Gonzalez and Richard.E. Woods, "Digital Image Processing", Third Edition, Prentice Hall, 2008.
2. Oge Marques, "Practical Image and Video Processing using MATLAB", Wiley-IEEE Press, 2011.

Reference Books and Resources

1. Rafael. C. Gonzalez, Richard. E. Woods and Steven L. Eddins, "Digital Image Processing using MATLAB", 2nd Edition, Gatesmark Publishing, 2009.
2. Al.Bovik, "The Essential Guide to Image Processing", Academic Press, 2009.
3. Anil K.Jain, "Fundamentals of Digital Image Processing", Pearson Education 2003.
4. William K. Pratt, "Digital Image Processing", Third Edition, John Wiley, 2001.
5. www.imageprocessingplace.com.
6. <https://www.coursera.org/course/images>.
7. <http://www.mathworks.com>. Modality

Course Contents and Lecture Schedule

No.	Topic	No. of Lectures
1	Imaging Technologies	
	Course overview: Introduction to Image processing, it's need and applications, Course objectives and outcomes overview	2
1.1	CCD, CMOS	1
1.2	X-Ray, CT, MRI, Ultrasound	1
1.3	SAR	1
1.4	IR	
1.5	Thermal	
2	Digital Image model	
2.1	Illuminance and Reflectance	1
3	Digitization	
3.1	Sampling and Quantization	1
3.2	Image Formats	
4	Relationship between pixels	
4.1	Connectivity	2
4.2	Distance Measures	
5.	Noise	
5.1	Uniform, Gaussian, Salt and Pepper	1

6.	Transforms	
6.1	Fourier	2
6.2	Discrete cosine	1
7	Image Enhancement	
7.1	Spatial domain	
7.1.1	Gray level Transformations	1
7.1.2	Histogram Processing	2
7.1.3	Smoothing Filters	2
7.1.4	Sharpening Filters	2
7.2	Frequency Domain	
7.2.1	Smoothing Filters	1
7.2.2	Sharpening Filters	1
8	Segmentation	
8.1	Thresholding based segmentation	1
8.2	Point, Line and Edge Detection, Laplacian mask, edges linking	2
8.3	Region based segmentation	
8.3.1	Region Growing	2
8.3.2	Region Splitting	
8.3.3	Region Merging	
9	Representation	
9.1	chain codes	1
10	Description	
10.1	Boundary	1
10.2	Region	
10.3	Texture	
10.4	Post Processing: Morphology, dilation, erosion, opening and closing	1
11	Real World Applications	
11.1	License plate detection	1
11.2	Missing component detection for automatic industry inspection	1
11.3	X-ray, CT, MRI Ultra sound image analysis for abnormality detection	1
11.4	Fault analysis in power system	1
11.5	Remote sensing- change detection, building, road extraction in satellite images	1
11.6	Digital image watermarking	1
	Total	36

Course Designer:

1.	Dr.B.Yogameena	ymece@tce.edu
----	----------------	---------------